

# EWV/EVL-J

Water to water screw  
heat pump

# Installation, maintenance & operation manual



EWVD-J (EWLD-J)  
EWWH-J (EWLH-J)  
EWS-S-J (EWLS-J)

Rev	06
Date	May 2023
Supersedes	D-EIMWC01008-16_05EN

# CONTENTS

<b>1</b>	<b>INTRODUCTION</b> .....	<b>5</b>
1.1	Precautions against residual risks .....	5
1.2	Description .....	6
1.3	Information about the refrigerants used.....	6
1.3.1	Pressure/temperature tables .....	7
<b>2</b>	<b>INSTALLATION REQUIREMENTS</b> .....	<b>9</b>
2.1	Information about installation of systems with R134a and R513A .....	9
2.2	Information about installation of systems with R1234ze .....	9
2.2.1	Additional guidelines for safe use of R1234ze(E) for equipment located in the open air .....	9
2.2.2	Additional guidelines for safe use of R1234ze(E) for equipment located in a machinery room .....	9
<b>3</b>	<b>RECEIVING THE UNIT</b> .....	<b>12</b>
<b>4</b>	<b>OPERATING LIMITS</b> .....	<b>13</b>
4.1	Storing Storage .....	13
4.2	Operation .....	13
4.2.1	Options and features .....	13
4.2.2	Operation range .....	14
<b>5</b>	<b>MECHANICAL INSTALLATION</b> .....	<b>20</b>
5.1	Safety .....	20
5.2	Moving and lifting .....	20
5.3	Positioning and assembly .....	20
5.4	Noise and Sound protection .....	21
5.5	Water piping .....	21
5.5.1	Water piping installation procedure .....	22
5.5.2	Piping insulation .....	23
5.6	Water flow and quality .....	23
5.7	Evaporator and recovery exchangers anti-freeze protection.....	25
5.8	Before Starting .....	25
<b>6</b>	<b>GUIDELINES FOR REMOTE CONDENSER APPLICATION (EWLD J, EWLH and EWLS versions)</b> .....	<b>26</b>
6.1	Installation information for condenserless units.....	26
6.1.1	Precautions when handling piping .....	26
6.1.2	Leak test and vacuum drying .....	26
6.1.3	Charging the unit .....	27
6.2	Refrigerant piping design .....	27
6.2.1	Equivalent line length .....	29
6.2.2	Liquid line sizing .....	29
6.2.3	Discharge (Hot Gas) Line Sizing .....	30
6.2.4	Oil charge .....	31
<b>7</b>	<b>ELECTRICAL INSTALLATION</b> .....	<b>32</b>
7.1	General specifications .....	32
7.2	Electrical supply .....	32
7.3	Electric connections .....	32
7.4	Cable requirements .....	33
7.5	Phase unbalance .....	33
<b>8</b>	<b>OPERATION</b> .....	<b>35</b>
8.1	Operator's responsibilities .....	35
<b>9</b>	<b>MAINTENANCE</b> .....	<b>36</b>
9.1	Routine maintenance .....	36
<b>10</b>	<b>SERVICE AND LIMITED WARRANTY</b> .....	<b>38</b>
<b>11</b>	<b>PERIODIC CHECKS AND COMMISSIONING OF PRESSURE EQUIPMENT</b> .....	<b>38</b>
<b>12</b>	<b>DISPOSAL</b> .....	<b>38</b>
<b>13</b>	<b>IMPORTANT INFORMATION REGARDING THE REFRIGERANT USED</b> .....	<b>39</b>
13.1	Factory and Field charged units instructions .....	39

## LIST OF FIGURES

<i>Figure 1 - Typical refrigerant circuit</i> .....	3
<i>Figure 2 - Description of the labels applied to the electrical panel</i> .....	4
<i>Figure 3- Lifting</i> .....	20
<i>Figure 4- Unit Levelling</i> .....	21
<i>Figure 5 - Condenser located with no elevation difference</i> .....	28
<i>Figure 6 - Condenser located above the unit</i> .....	28
<i>Figure 7 - Condenser located below the unit</i> .....	29
<i>Figure 8 - Equivalent lengths (in meters)</i> .....	29

Control equipment	
PZH	High Pressure Switch 21,0bar
PT	Pressure Transducer
TT	Temperature Transducer
TZAH	High Temperature Switch
TZAL	Low Pressure Limiter

Equipment	
1	Compressor
2	Shut off valve
3	Condenser
4	Shut off valve
5	Filter drier
6	Shut off valve (charge valve)
7	Solenoid valve
8	Liquid indicator

9	Expansion valve
10	Evaporator
11	Shut off valve
12	Filter
13	Solenoid valve
14	Pressure Relief valve 15,5bar
15	Pressure Relief valve 23,5bar
16	Flow Switch
17	Filter

**ATTENTION:**

For the units EWLD/EWLH/EWLS the letter L means that the unit is condensersless.  
Condenser (3) is not present.

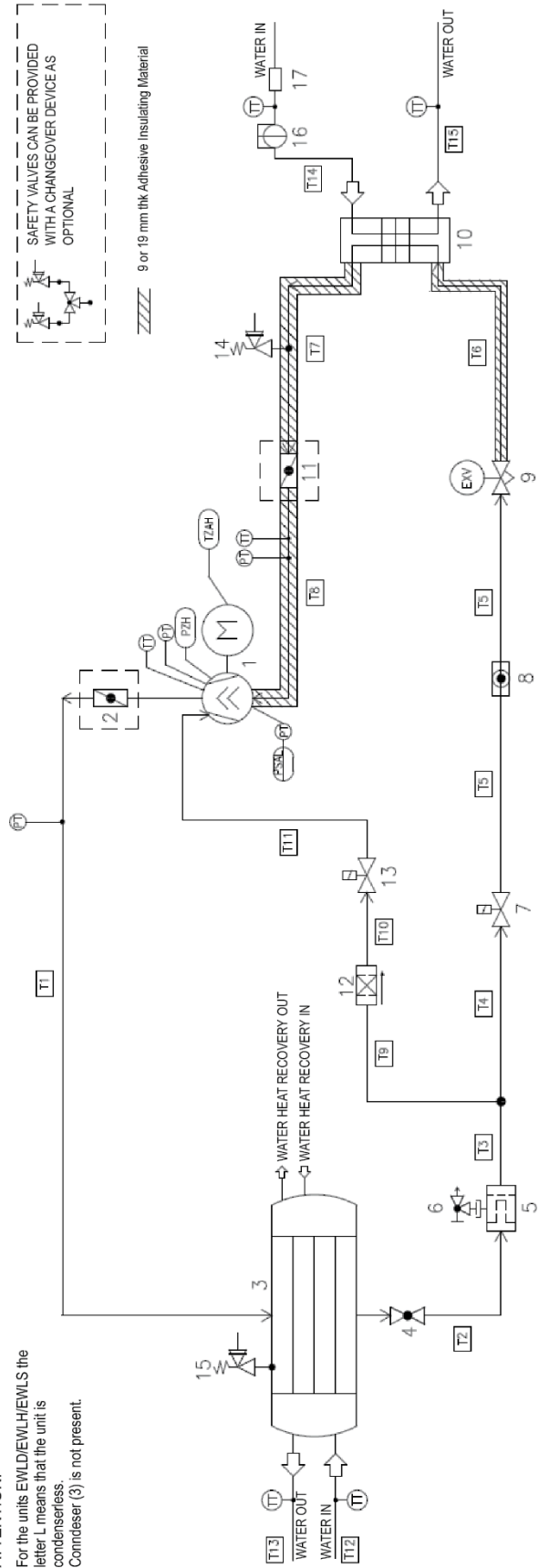

**Figure 1 - Typical refrigerant circuit**

Water inlet and outlet are indicative. Please refer to the machine dimensional diagrams for exact water connections.

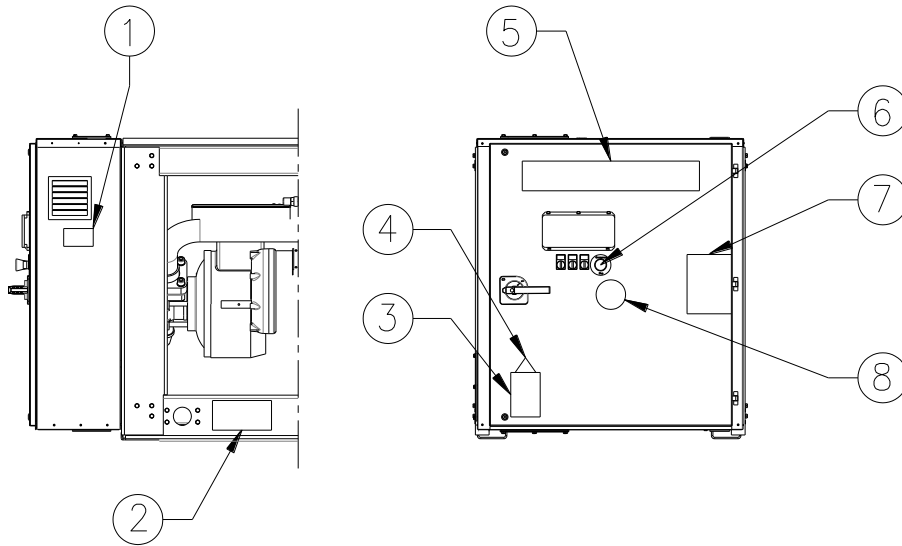

### Label Identification

1 – Unit nameplate data	5 – Manufacturer's logo
2 – Lifting instructions	6 – Emergency stop
3 – Hazardous Voltage warning	7 – Non-flammable gas symbol
4 – Electrical hazard symbol	8 – Gas type

**Figure 2 - Description of the labels applied to the electrical panel**

# 1 INTRODUCTION

---

**This manual is an important supporting document for qualified personnel but it is not intended to replace such personnel.**



***READ THIS MANUAL CAREFULLY BEFORE INSTALLING AND STARTING UP THE UNIT. IMPROPER INSTALLATION COULD RESULT IN ELECTRIC SHOCK, SHORT-CIRCUIT, LEAKS, FIRE OR OTHER DAMAGE TO THE EQUIPMENT OR INJURE TO PEOPLE.***



***THE UNIT MUST BE INSTALLED BY A PROFESSIONAL OPERATOR/TECHNICIAN  
UNIT STARTUP HAS TO BE PERFORMED BY AUTHORIZED AND TRAINED  
PROFESSIONAL  
ALL ACTIVITIES HAVE TO BE PERFORMED ACCORDING TO LOCAL LAWS AND  
REGULATION.***



***UNIT INSTALLATION AND START UP IS ABOSOLUTELY FORBIDDEN IF ALL  
INSTRUCTION CONTAINED IN THIS MANUAL ARE NOT CLEAR.  
IF CASE OF DOUBT CONTACT THE MANUFACTURER REPRESENTATIVE FOR ADVICE  
AND INFORMATION.***

## 1.1 Precautions against residual risks

1. install the unit according to the instructions set out in this manual
2. regularly carry out all the maintenance operations foreseen in this manual
3. wear protective equipment (gloves, eye protection, hard hat, etc.) suited to the work in hand; do not wear clothes or accessories that can get caught or sucked in by flows of air; tie back long hair before entering the unit
4. before opening the machine panelling make sure that it is firmly hinged to the machine
5. the fins on heat exchangers and the edges of metal components and panels can cause cuts
6. do not remove the guards from mobile components while the unit is operating
7. make sure that mobile component guards are fitted correctly before restarting the unit
8. fans, motors and belts drives might be running: before entering, always wait for these to stop and take appropriate measures to prevent them from starting up
9. the surfaces of the machine and pipes can get very hot or cold and cause the risk of scalding
10. never exceed the maximum pressure limit (PS) of the water circuit of the unit.
11. before removing parts on the pressurised water circuits, close the section of the piping concerned and drain the fluid gradually to stabilise the pressure at the atmospheric level
12. do not use your hands to check possible refrigerant leaks
13. disable the unit from the mains using the main switch before opening the control panel
14. check that the unit has been grounded correctly before starting it
15. install the machine in a suitable area; in particular, do not install it outdoors if it is intended for use indoors
16. do not use cables with inadequate sections nor extension cord connections, even for very short periods or emergencies
17. for units with power correction capacitors, wait 5 minutes after removing the electric power supply before accessing the inside of the switch board
18. if the unit is equipped with compressors with integrated inverter, disconnect it from the mains and wait a minimum of 20 minutes before accessing it to carry out maintenance: residual energy in the components, which takes at least this length of time to dissipate, poses the risk of electrocution
19. the unit contains pressurised refrigerant gas: the pressurised equipment must not be touched except during maintenance, which must be entrusted to qualified and authorised personnel
20. connect up the utilities to the unit following the indications set out in this manual and on the panelling of the unit itself
21. In order to avoid an environmental risk, make sure that any leaking fluid is collected in suitable devices in accordance with local regulations.
22. if a part needs to be dismantled, make sure it is correctly re-assembled before starting the unit
23. when the rules in force require the installation of fire-fighting systems near the machine, check that these are suitable for extinguishing fires on electrical equipment and on the lubricating oil of the compressor and the refrigerant, as specified on the safety data sheets of these fluids
24. when the unit is equipped with devices for venting overpressure (safety valves): when these valves are triggered, the refrigerant gas is released at a high temperature and speed; prevent the release of gas from harming people or objects and, if necessary, discharge the gas according to the provisions of EN 378-3 and the local regulations in force.
25. keep all the safety devices in good working order and check them periodically according to the regulations in force
26. keep all lubricants in suitably marked containers
27. do not store inflammable liquids near the unit
28. solder or braze only empty pipes after removing all traces of lubricant oil; do not use flames or other heat sources in the vicinity of pipes containing refrigerant fluid
29. do not use naked flames near the unit

30. the machinery must be installed in structures protected against atmospheric discharge according to the applicable laws and technical standards
31. do not bend or hit pipes containing pressurised fluids
32. it is not permitted to walk or rest other objects on the machines
33. the user is responsible for overall evaluation of the risk of fire in the place of installation (for example, calculation of the fire load)
34. during transport, always secure the unit to the bed of the vehicle to prevent it from moving about and overturning
35. the machine must be transported according to the regulations in force taking into account the characteristics of the fluids in the machine and the description of these on the safety data sheet
36. inappropriate transport can cause damage to the machine and even leaking of the refrigerant fluid. Before start-up, the machine must be checked for leaks and repaired accordingly.
37. the accidental discharge of refrigerant in a closed area can cause a lack of oxygen and, therefore, the risk of asphyxiation: install the machinery in a well ventilated environment according to EN 378-3 and the local regulations in force.
38. the installation must comply with the requirements of EN 378-3 and the local regulations in force; in the case of installations indoors, good ventilation must be guaranteed and refrigerant detectors must be fitted when necessary.

## 1.2 Description

The unit purchased is a Heat Pump, that is a machine designed to cool/heat the water (or a water-glycol mixture) within certain limits which will be listed below. The unit operates based on the compression, condensation and evaporation of the coolant gas as per the Carnot cycle, and is composed mainly of the following parts depending on the Mode of Operation.

### Cooling or Conditioning Mode:

- Screw compressors which increase the pressure of the refrigerant gas from evaporation pressure to condensation pressure.
- A water-cooled condenser where the refrigerant gas condenses under high pressure and transfers heat to the water.
- An expansion valve which allows the pressure of condensed liquid refrigerant to be reduced from condensation pressure to evaporation pressure.
- A water-cooled evaporator, where the low-pressure liquid refrigerant evaporates and chills the water.

### Heating Mode or Heat Pump:

- Screw compressors which increase the pressure of the refrigerant gas from evaporation pressure to condensation pressure.
- A condenser where the refrigerant gas condenses under high pressure and transfers heat to the water.
- An expansion valve which allows the pressure of condensed liquid refrigerant to be reduced from condensation pressure to evaporation pressure.
- An evaporator, where the low-pressure liquid refrigerant evaporates and chills the water.
- The operation of the heat exchangers can be inverted connecting the user piping to the Brazed Plate Heat exchanger (chilled water) or to the shell&tube heat exchanger (heated water).

All standard units are fully assembled in Daikin Applied Europe factory and tested before shipping, only the condenserless units can not be tested.

The EWWD(H/S)-J range consists of models with a single refrigerant circuit (from 90 to 120 kW).

The machine uses three type of refrigerant fluids: R134a, R1234ze, R513A with different envelopes.

The controller is pre-wired, set up and tested at the factory. Only normal field connections such as piping, electrical connections and pump interlocks are required, simplifying installation and increasing reliability. All safety and operation control systems are installed at the factory in the control panel.

The instructions in this manual are applicable to all models in this series unless otherwise specified.

## 1.3 Information about the refrigerants used

This product contains fluorinated greenhouse gases. Do not vent gases into the atmosphere.

Models	EWWD J EWLD J	EWWH J EWLH J	EWWS J EWLS J
Refrigerant type	R134a	R1234ze	R513A
GWP <sup>(1)</sup> value	1430	7	572

For the EWWD J, EWWH J and EWWS J unit versions the quantity is indicated on the unit name plate.

For the EWLD J, EWLH J and EWLS J unit versions, please fill the total refrigerant charge in with indelible ink on the refrigerant charge label supplied with the product.

The filled-out label must be adhered inside the electric panel door.

<sup>(1)</sup> GWP = global warming potential

Refrigerants R134a, R1234ze(E) and R513A are classified by European Directive 2014/68/EU as Group 2 (non-dangerous) substances as it is nonflammable at standard ambient temperature and non-toxic. Due to this, no special precautions are required for storage, transport, and handling.

Daikin Applied Europe S.p.A. products comply with applicable European Directives and refer for unit design to product Standard EN378:2016 and industrial Standard ISO5149. Local authorities' approval should be verified referring to European Standard EN378 and/or ISO 5149 (where R134a and R513A are classified A1, and R1234ze(E) is classified A2L – Mildly flammable gas).

### 1.3.1 Pressure/temperature tables

#### - R134a

<b>R134a Pressure/ Temperature conversion table</b>									
°C	bar	°C	bar	°C	bar	°C	bar	°C	bar
-15	1,64	4	3,38	23	6,27	43	11,01	62	17,62
-14	1,71	5	3,50	25	6,46	44	11,30	63	18,04
-13	1,78	6	3,62	26	6,65	45	11,60	64	18,46
-12	1,85	7	3,75	27	6,85	46	11,90	65	18,89
-11	1,93	8	3,88	28	7,06	47	12,21	66	19,33
-10	2,01	9	4,01	29	7,27	48	12,53	67	19,78
-9	2,09	10	4,15	30	7,48	49	12,85	68	20,23
-8	2,17	11	4,29	31	7,70	50	13,18	69	20,69
-7	2,26	12	4,43	32	7,92	51	13,51	70	21,16
-6	2,34	13	4,58	33	8,15	52	13,85	71	21,64
-5	2,43	14	4,73	34	8,39	53	14,20	72	22,13
-4	2,53	15	4,88	35	8,63	54	14,55	73	22,62
-3	2,62	16	5,04	36	8,87	55	14,91	74	23,12
-2	2,72	17	5,20	37	9,12	56	15,28	75	23,63
-1	2,82	18	5,37	38	9,37	57	15,65	76	24,15
0	2,93	19	5,54	39	9,63	58	16,03	77	24,68
1	3,04	20	5,72	40	9,89	59	16,42	78	25,22
2	3,15	21	5,90	41	10,16	60	16,81	79	25,77
3	3,26	22	6,08	42	10,44	61	17,22	80	26,32

#### - R1234ze (E)

<b>HFO-R1234ze(E) Pressure/ Temperature conversion table</b>									
°C	bar	°C	bar	°C	bar	°C	bar	°C	bar
-15	1,20	4	2,50	23	4,69	43	8,31	62	13,39
-14	1,25	5	2,59	25	4,84	44	8,53	63	13,71
-13	1,30	6	2,69	26	4,98	45	8,76	64	14,03
-12	1,36	7	2,78	27	5,14	46	8,99	65	14,36
-11	1,42	8	2,88	28	5,29	47	9,23	66	14,70
-10	1,47	9	2,98	29	5,45	48	9,47	67	15,04
-9	1,53	10	3,08	30	5,62	49	9,72	68	15,39
-8	1,60	11	3,19	31	5,78	50	9,97	69	15,75
-7	1,66	12	3,30	32	5,95	51	10,23	70	16,11
-6	1,73	13	3,41	33	6,13	52	10,49	71	16,48
-5	1,79	14	3,52	34	6,31	53	10,76	72	16,85
-4	1,86	15	3,64	35	6,49	54	11,03	73	17,23
-3	1,94	16	3,76	36	6,67	55	11,30	74	17,62
-2	2,01	17	3,88	37	6,86	56	11,58	75	18,01
-1	2,09	18	4,01	38	7,06	57	11,87	76	18,41
0	2,17	19	4,14	39	7,25	58	12,16	77	18,81
1	2,25	20	4,27	40	7,46	59	12,46	78	19,23
2	2,33	21	4,41	41	7,66	60	12,76	79	19,65
3	2,41	22	4,55	42	7,87	61	13,07	80	20,07

- R513A

<b>R513A Pressure/ Temperature conversion table</b>									
<b>°C</b>	<b>bar</b>	<b>°C</b>	<b>bar</b>	<b>°C</b>	<b>bar</b>	<b>°C</b>	<b>bar</b>	<b>°C</b>	<b>bar</b>
-15	1,87	4	3,73	23	6,74	43	11,58	62	18,25
-14	1,94	5	3,85	25	6,93	44	11,88	63	18,66
-13	2,02	6	3,98	26	7,13	45	12,18	64	19,09
-12	2,10	7	4,11	27	7,34	46	12,49	65	19,52
-11	2,18	8	4,25	28	7,55	47	12,80	66	19,96
-10	2,27	9	4,39	29	7,77	48	13,12	67	20,40
-9	2,35	10	4,53	30	7,99	49	13,44	68	20,86
-8	2,44	11	4,68	31	8,21	50	13,77	69	21,32
-7	2,53	12	4,83	32	8,44	51	14,11	70	21,79
-6	2,63	13	4,98	33	8,67	52	14,46	71	22,27
-5	2,72	14	5,14	34	8,91	53	14,81	72	22,75
-4	2,82	15	5,30	35	9,16	54	15,16	73	23,24
-3	2,93	16	5,47	36	9,41	55	15,52	74	23,75
-2	3,03	17	5,64	37	9,66	56	15,89	75	24,26
-1	3,14	18	5,81	38	9,92	57	16,27	76	24,78
0	3,25	19	5,99	39	10,18	58	16,65	77	25,30
1	3,36	20	6,17	40	10,45	59	17,04	78	25,84
2	3,48	21	6,35	41	10,72	60	17,43	79	26,38
3	3,60	22	6,54	42	11,00	61	17,84	80	26,94



## 2 INSTALLATION REQUIREMENTS

---

Before machine installation and commissioning, the people involved in this activity must have acquired the information necessary to carry out these tasks, applying all the information collected in this book all the procedures reported in the aforementioned norms and the provided requirements by the local law.  
Do not allow unauthorized and/or unskilled personnel to access the unit.

### 2.1 Information about installation of systems with R134a and R513A

According to the standard EN 378-1-2016, any refrigerant system that contains R134a or R513A, can be installed without any restriction in open air or machinery rooms. Anyway, the building owner or the end user shall ensure that that access is permitted only by qualified and trained personnel, who is aware of the general safety precautions of the building. It is recommended to satisfy all the requirements listed in the EN 378-3-2016 for the installation.

The refrigerant shall not be able to flow into any adjacent room, doorway, or exhaust system in the event of a leak.

It is advised to install a refrigerant detection system which works also during the normal operation of the refrigerant system: in case of refrigerant leak indeed, it can activate the alarm and all the necessary emergency procedures until the machine shutdown.

The alarm shall also advice the authorized personnel to take the necessary steps. The refrigerant leak detector shall be supplied by the user because it is a key component of the sprinkler system of the entire building.

### 2.2 Information about installation of systems with R1234ze

This product can be equipped with refrigerant R1234ze(E) which has minimal impact to the environment, thanks to its low value of Global Warming Potential (GWP).

Refrigerant type	R1234ze
Safety Class	A2L
PED Fluid Group	2
Practical limit (kg/m <sup>3</sup> )	0.061
ATEL/ ODL (kg/m <sup>3</sup> )	0.28
LFL (kg/m <sup>3</sup> ) @ 60°C	0.303
Vapour density @25°C, 101.3 kPa (kg/m <sup>3</sup> )	4.66
Molecular Mass	114.0
Normal Boiling Point (°C)	-19
GWP (100 yr ITH)	7
GWP (ARS 100 yr ITH)	<1
Auto Ignition Temperature (°C)	368

The chillers are built in accordance with the main European Directives (Machinery Directive, Low Voltage Directive, Electromagnetic Compatibility Directive, Pressurized Equipment Directive), make sure you also receive the declaration of product conformity with the directives along with the documentation.

**Before machine installation and commissioning, the people involved in this activity must have acquired the information necessary to carry out these tasks, applying all the information collected in this book. Do not allow unauthorized and/or unskilled personnel to access the unit.**

The chiller has to be installed in open air or machinery room (location classification III).

To ensure location classification III a mechanical vent on the secondary circuit(s) has to be installed.

Local building codes and safety standards shall be followed; in absence of local codes and standards refer to EN 378-3:2016 as a guide. In paragraph "Additional guidelines for safe use of R1234ze(E)" there are provided additional information that should be added to the requirements of safety standards and building codes.

#### 2.2.1 Additional guidelines for safe use of R1234ze(E) for equipment located in the open air

Refrigerating systems sited in the open air shall be positioned to avoid leaked refrigerant flowing into a building or otherwise endangering people and property.

The refrigerant shall not be able to flow into any ventilation fresh air opening, doorway, trap door or similar opening in the event of a leak. Where a shelter is provided for refrigerating equipment sited in the open air it shall have natural or forced ventilation.

For refrigeration systems installed outside in a location where a release of refrigerant can stagnate e.g., below ground, then the installation shall comply with the requirements for gas detection and ventilation of machinery rooms.

#### 2.2.2 Additional guidelines for safe use of R1234ze(E) for equipment located in a machinery room

When a machinery room is chosen for the location of the refrigerating equipment it shall be located in accordance with local and national regulations. The following requirements (according to EN 378-3:2016) can be used for the assessment.

- A risk analysis based on the safety concept for the refrigerating system (as determined by the manufacturer and including the charge and safety classification of the refrigerant used) shall be conducted to determine whether it is necessary to place the refrigerating system in a separate refrigeration machinery room.
- Machinery rooms should not be used as occupied spaces. The building owner or user shall ensure that access is permitted only by qualified and trained personnel doing the necessary maintenance to the machinery room or general plant.
- Machinery rooms shall not be used for storage with the exception of tools, spare parts and compressor oil for the installed equipment. Any refrigerants, or flammable or toxic materials shall be stored as required by national regulations.
- Open (naked) flames shall not be permitted in machinery rooms, except for welding, brazing or similar activity and then only provided the refrigerant concentration is monitored and adequate ventilation is ensured. Such open flames shall not be left unattended.
- A remote switching (emergency type) for stopping the refrigerating system shall be provided outside the room (near the door). A similar acting switch shall be located at a suitable location inside the room.
- All piping and ducting passing through floors, ceiling and walls of machinery room shall be sealed.
- Hot surfaces shall not exceed a temperature of 80 % of the auto-ignition temperature (in °C) or 100 K less than the auto-ignition temperature of the refrigerant, whichever is higher.

Refrigerant	Auto ignition temperature	Maximum surface temperature
R1234ze	368 °C	294 °C

- Machinery rooms shall have doors opening outward and sufficient in number to ensure freedom for persons to escape in an emergency; the doors shall be tight fitting, self-closing and so designed that they can be opened from inside (antipanic system).
- Special machinery rooms where the refrigerant charge is above the practical limit for the volume of the room shall have a door that either opens directly to the outside air or through a dedicated vestibule equipped with self-closing, tight-fitting doors.
- The ventilation of machinery rooms shall be sufficient both for normal operating conditions and emergencies.
- Ventilation for normal operating conditions shall be in accordance with national regulations.
- The emergency mechanical ventilation system shall be activated by a detector(s), located in the machinery room.
  - This ventilation system shall be:
    - independent of any other ventilation system on the site.
    - provided with two independent emergency controls one located outside the machinery room, and the other inside.
  - The emergency exhaust ventilation fan shall:
    - Be either in the air flow with the motor outside the airflow or rated for hazardous areas (according to the assessment).
    - Be located to avoid pressurization of the exhaust ductwork in the machinery room.
    - Not cause sparks to occur if it contacts the duct material.
  - Airflow of the emergency mechanical ventilation shall be at least

$$V = 0,014 \times m^{2/3}$$

where

V is the air flow rate in m<sup>3</sup>/s;  
m is the mass of refrigerant charge, in kg, in the refrigerating system with the largest charge, any part of which is located in the machinery room;  
0,014 is a conversion factor.

- Mechanical ventilation shall be operated continuously or shall be switched on by the detector.
- Detector shall automatically activate an alarm, start mechanical ventilation, and stop the system when it triggers.
- The location of detectors shall be chosen in relation to the refrigerant and they shall be located where the refrigerant from the leak will concentrate.
- The positioning of the detector shall be done with due consideration of local airflow patterns, accounting for location sources of ventilation and louvers. Consideration shall also be given to the possibility of mechanical damage or contamination.
- At least one detector shall be installed in each machinery room or the occupied space being considered and/or at the lowest underground room for refrigerants heavier than air and at the highest point for refrigerants lighter than air.

- Detectors shall be continuously monitored for functioning. In the case of a detector failure, the emergency sequence should be activated as if refrigerant had been detected.
- The pre-set value for the refrigerant detector at 30 °C or 0 °C, whichever is more critical, shall be set to 25 % of the LFL. The detector shall continue to activate at higher concentrations.

Refrigerant	LFL	Pre-set alarm	
R1234ze	0,303 kg/m <sup>3</sup>	0,07575 kg/m <sup>3</sup>	16500 ppm

- All electrical equipment (not only the refrigerating system) shall be selected to be suitable for use in the zones identified in the risk assessment. Electrical equipment shall be deemed to comply with the requirements if the electrical supply is isolated when the refrigerant concentration reaches 25 % of the lower flammable limit or less.
- Machinery rooms or special machinery rooms shall be clearly marked as such on the entrances to the room, together with warning notices indicating that unauthorized persons shall not enter and that smoking, naked light or flames are prohibited. The notices shall also state that, in the event of an emergency, only authorized persons conversant with emergency procedures shall decide whether to enter the machinery room. Additionally, warning notices shall be displayed prohibiting unauthorized operation of the system.
- The owner / operator shall keep an updated logbook of the refrigerating system.



***The optional leak detector supplied by DAE with the chiller should be used exclusively to check refrigerant leakage from the chiller itself.***

---

### **3 RECEIVING THE UNIT**

---

The unit must be inspected for any possible damage immediately upon reaching final place of installation. All components described in the delivery note must be inspected and checked.

Should the unit be damaged, do not remove the damaged material and immediately report the damage to the transportation company and request they inspect the unit.

Immediately report the damage to the manufacturer representative, a set of photographs are helpful in recognizing responsibility

Damage must not be repaired before the inspection of the transportation company representative.

Before installing the unit, check that the model and power supply voltage shown on the nameplate are correct.

Responsibility for any damage after acceptance of the unit cannot be attributed to the manufacturer.

## 4 OPERATING LIMITS

---

### 4.1 Storing Storage

Environmental conditions must be within the following limits:

Minimum ambient temperature : 5°C

Maximum ambient temperature : 55°C

Maximum R.H. : 95% not condensing

Storing below the minimum temperature may cause damage to components. Storing above the maximum temperature causes opening of safety valves. Storing in condensing atmosphere may damage electronic components.

### 4.2 Operation

The Daikin EWWD-J / EWLD-J / EWWH-J / EWLH-J / EWWS-J / EWLS-J packaged water-cooled water chillers are designed for indoor installation and used for cooling and heating applications. The EWWD J-EWLD J units are available in 16 standard sizes and for their nominal cooling capacities see tables. The EWWH J - EWLH J - EWWS J – EWLS J units are available in 7 standard sizes and for their nominal cooling capacities see tables.

The present installation manual describes the procedures for unpacking, installing, and connecting the EWWD J-EWLD J units.

#### 4.2.1 Options and features

##### Options

- Ampere and voltmeter
- Dual pressure relief valve on the condenser
- Low noise operation
- BMS-Connection (MODBUS, BACNET, LON)
- High temperature kit (only for EWWH J and EWLH J)

##### Features

- Glycol application for leaving evaporator water temperature down to –10°C (only for EWWD-EWLD-EWWS-EWLS)
- Sight glass with moisture indication
- Voltage free contacts
  - general operation/pump contact
  - alarm
- Changeable voltage free contacts
  - condenser pump
- Changeable remote inputs
  - remote start/stop
  - dual setpoint
  - enable/disable capacity limitation
- Changeable analog input
  - Setpoint override 4/20 mA
- Multiple language selection
- Filter kit for installation in front of the evaporator water (supplied accessories)

Operation is allowed within the following limits:

4.2.2 Operation range

- **EWWD-J:** from EWWD120J-SS to EWWD210J-SS

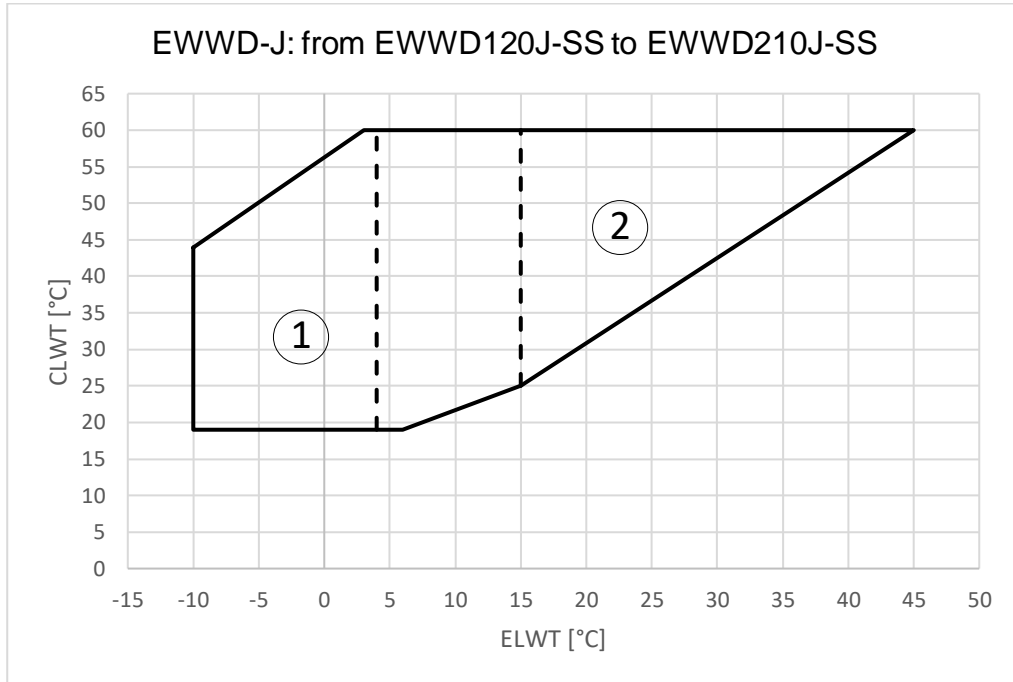

1. Operation with Glycol (below 4°C Evap LWT)
2. Option 189

- **EWWD-J:** EWWD250J-SS and EWWD280J-SS

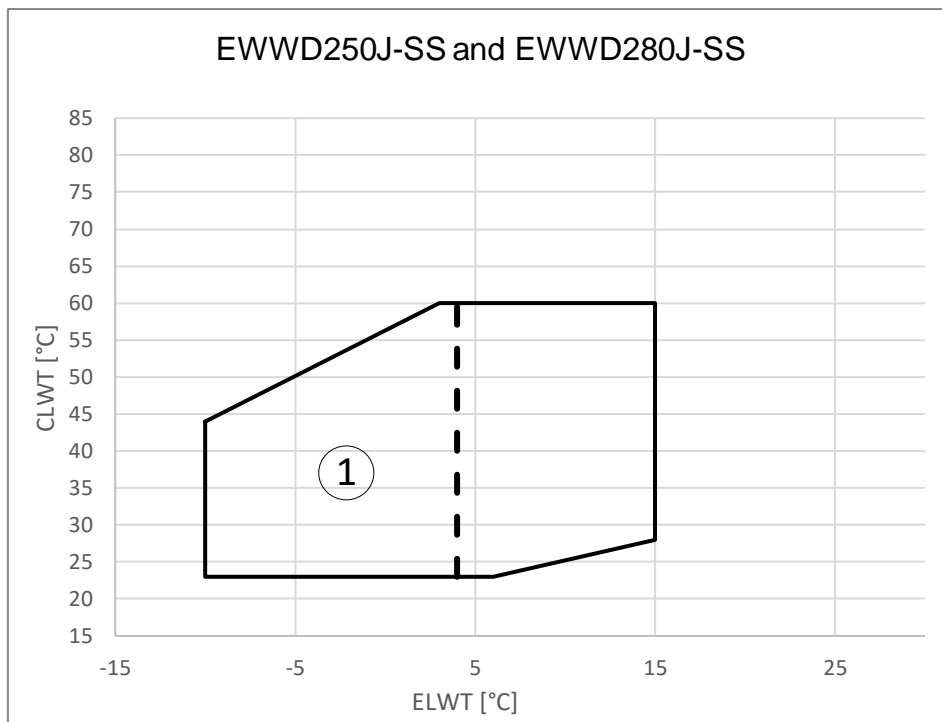

1. Operation with Glycol (below 4°C Evap LWT)

- **EWLD J: from EWLD110J-SS to EWLD195J-SS**

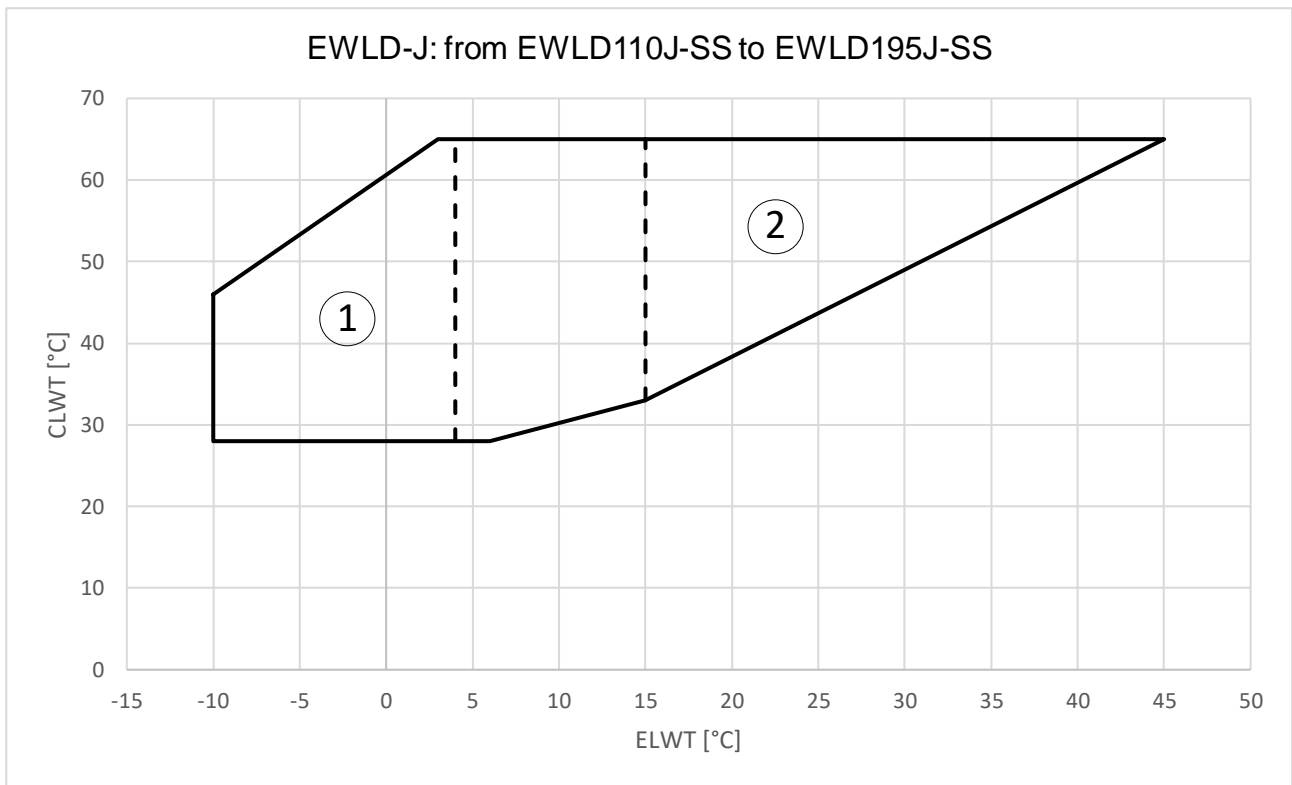

1. Operation with Glycol (below 4°C Evap LWT)
2. Option 189

- **EWLD J: EWLD235J-SS and EWLD265J-SS**

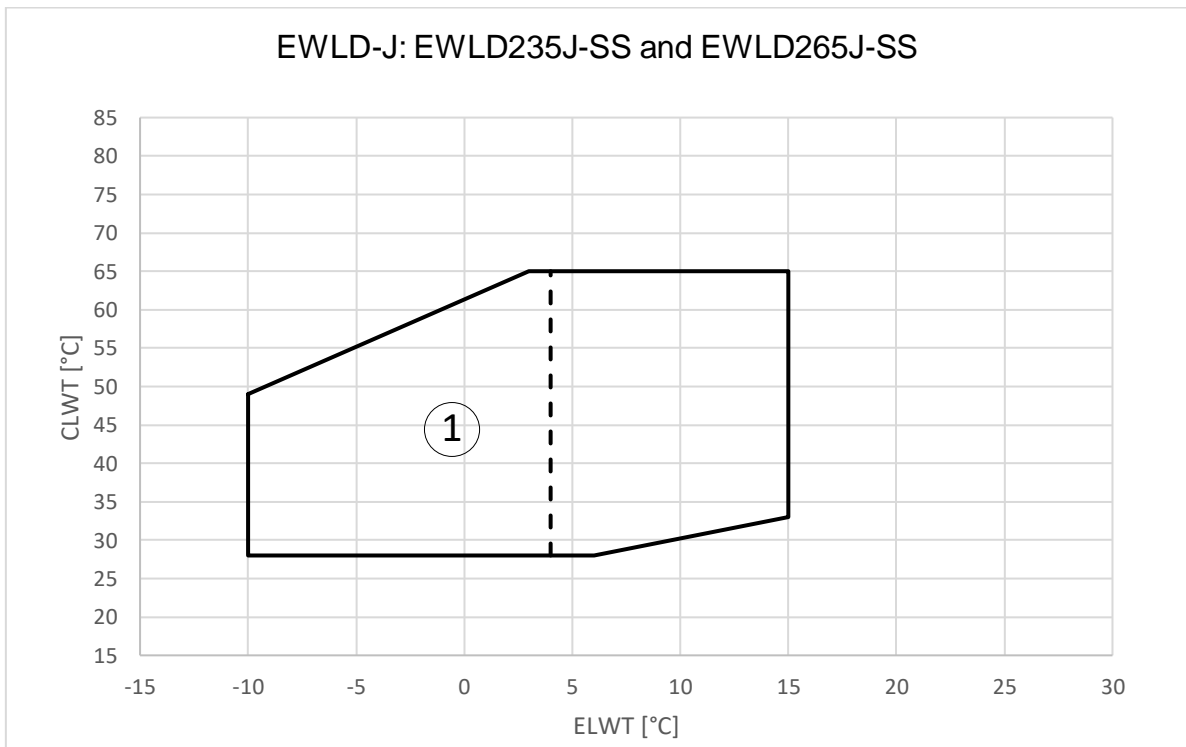

1. Operation with Glycol (below 4°C Evap LWT)

- **EWWH-J: from EWWH090-J to EWWH150-J**

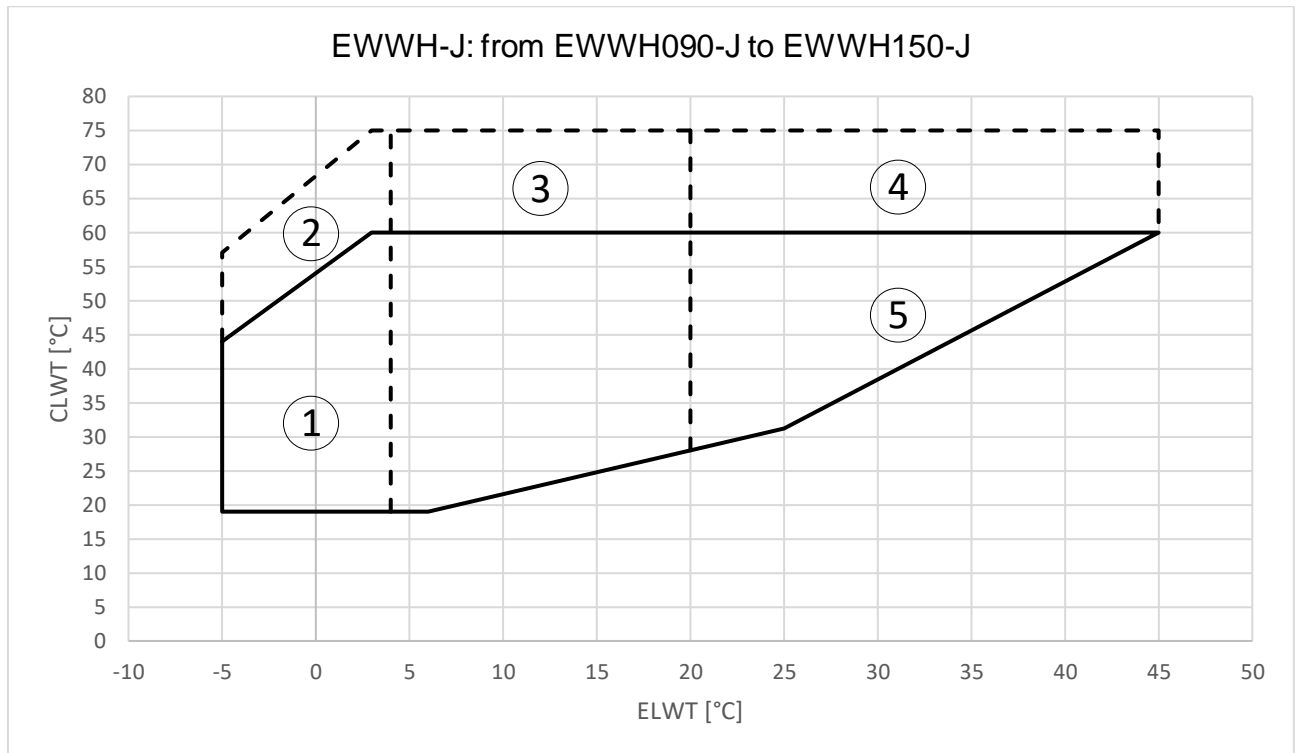

1. Operation with Glycol (below 4°C Evap LWT)
2. Option111 and operation with Glycol (below 4°C Evap LWT)
3. Option111
4. Option 111 + Option 189
5. Option 189

- **EWLH-J: from EWLH080-J to EWLH140-J**

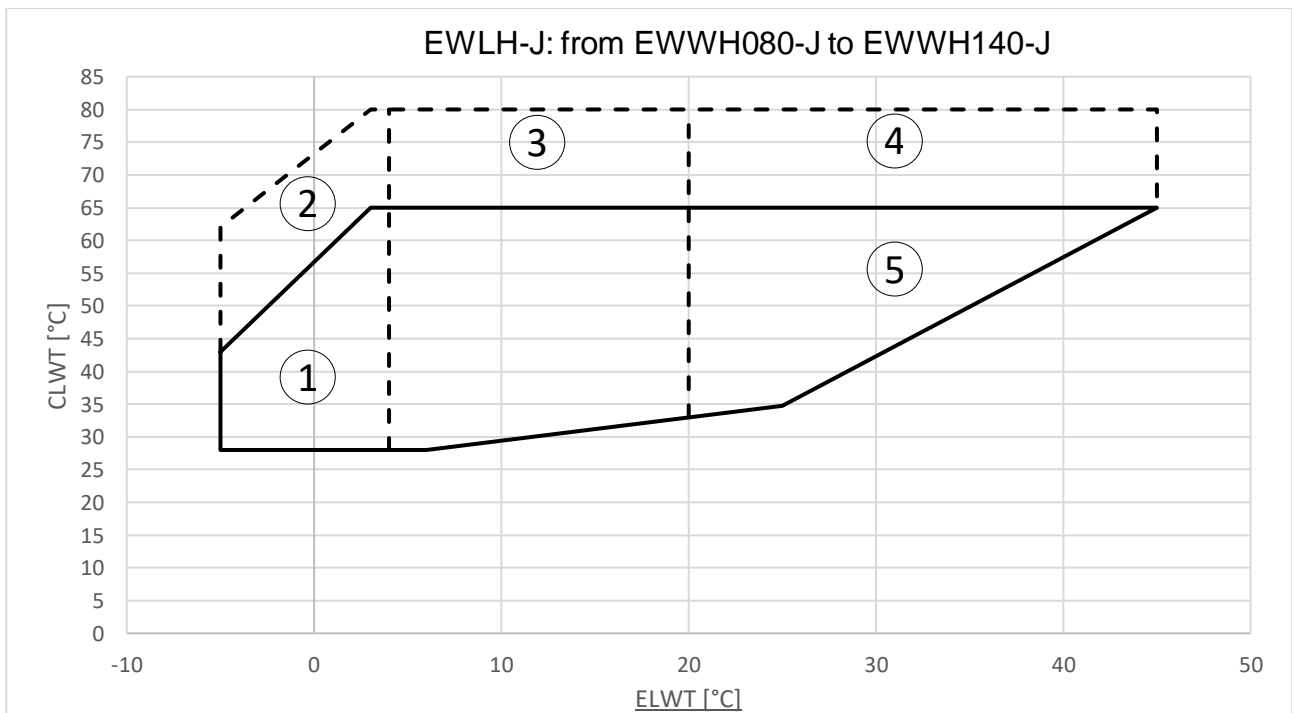

1. Operation with Glycol (below 4°C Evap LWT)
2. Option111 and operation with Glycol (below 4°C Evap LWT)
3. Option111
4. Option 111 + Option 189
5. Option 189



- **EWWH-J : EWWH180-J and EWWH200-J**

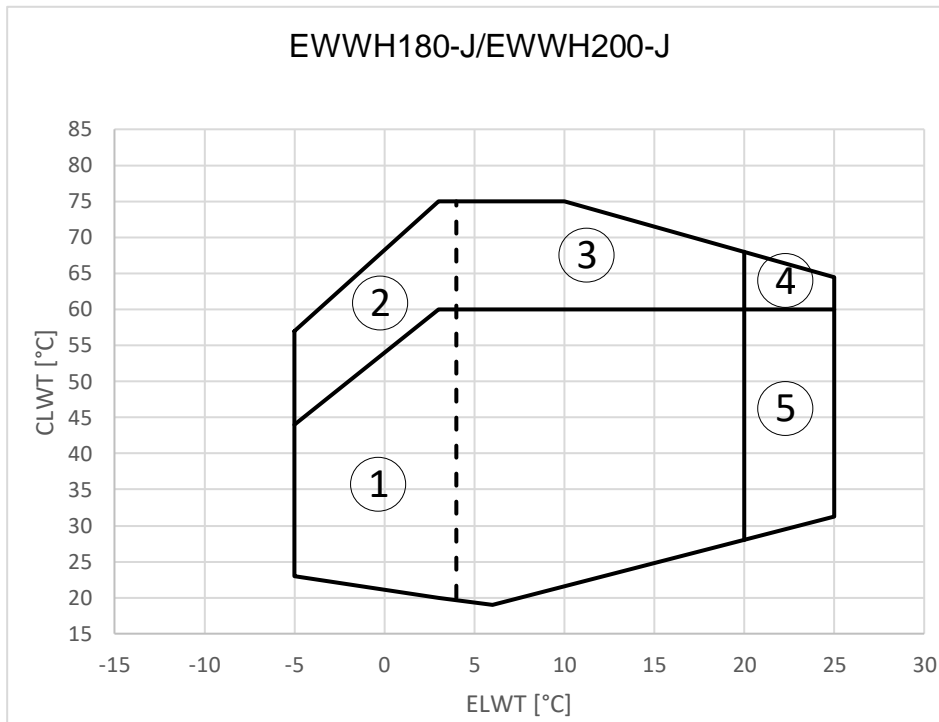

1. Operation with Glycol (below 4°C Evap LWT)
2. Option111 and operation with Glycol (below 4°C Evap LWT)
3. Option111
4. Option 111 + Option 189
5. Option 189

- **EWLH: EWLH180-J and EWLH200-J**

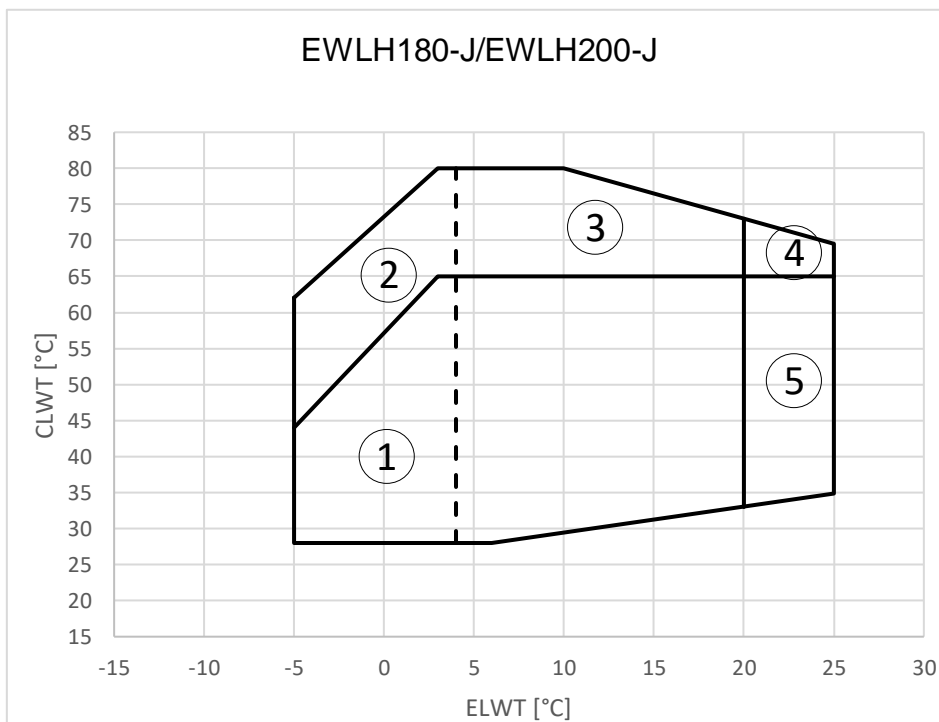

1. Operation with Glycol (below 4°C Evap LWT)
2. Option111 and operation with Glycol (below 4°C Evap LWT)
3. Option111
4. Option 111 + Option 189
5. Option 189

- **EWWS-J: from EWWS120-J to EWWS210-J**

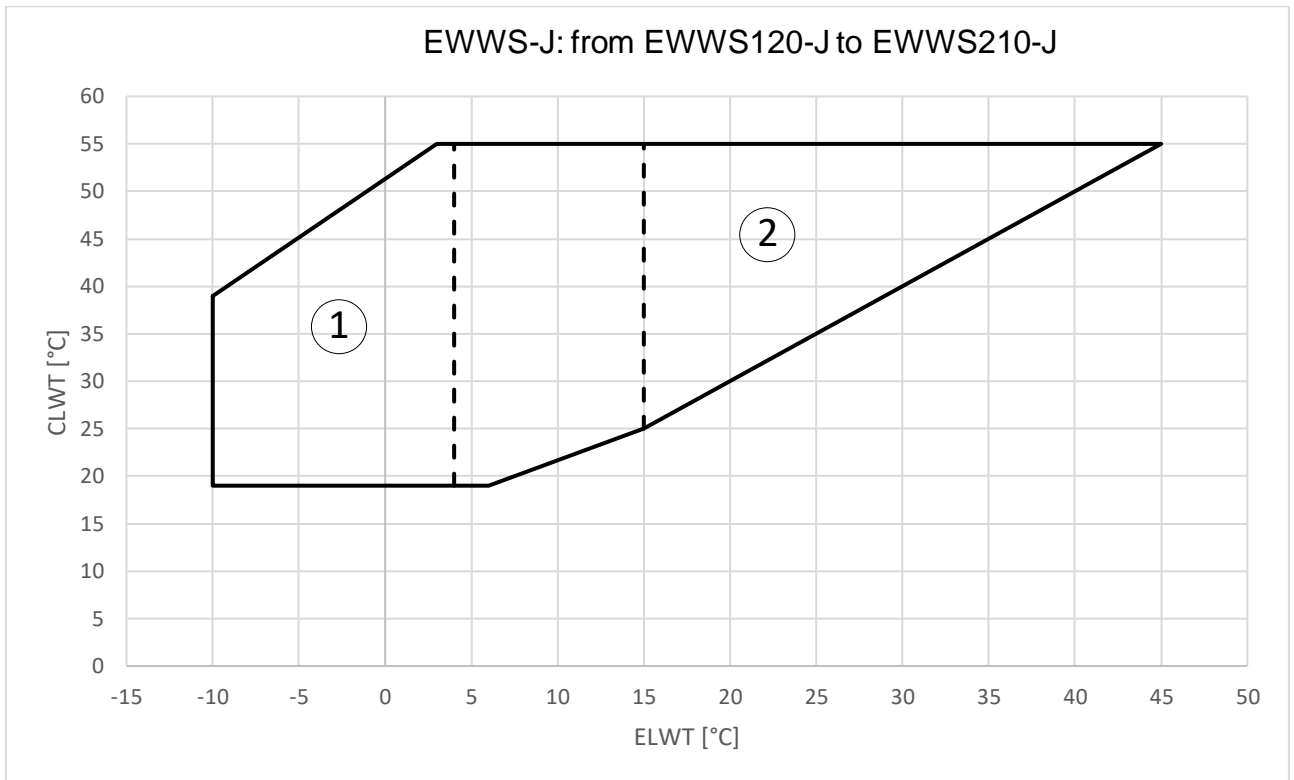

1. Operation with Glycol (below 4°C Evap LWT)
2. Option 189

- **EWWS-J: EWWS240-J and EWWS270J-SS**

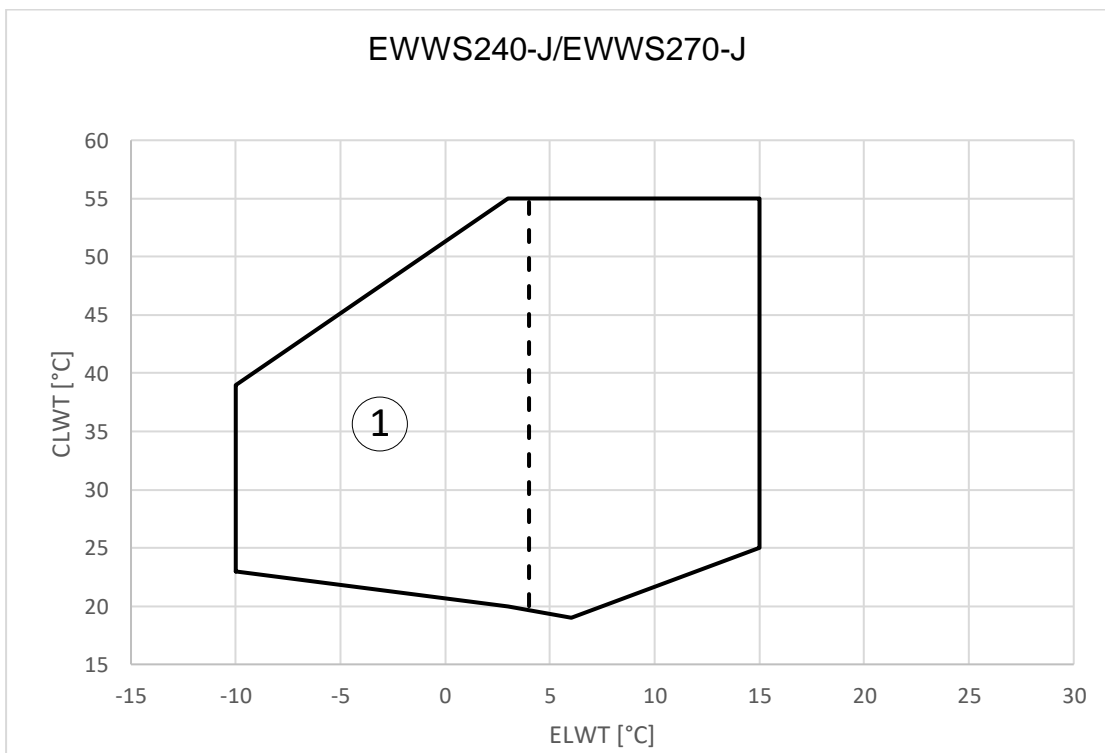

1. Operation with Glycol (below 4°C Evap LWT)

- **EWLS-J: from EWLS110-J to EWLS200-J**

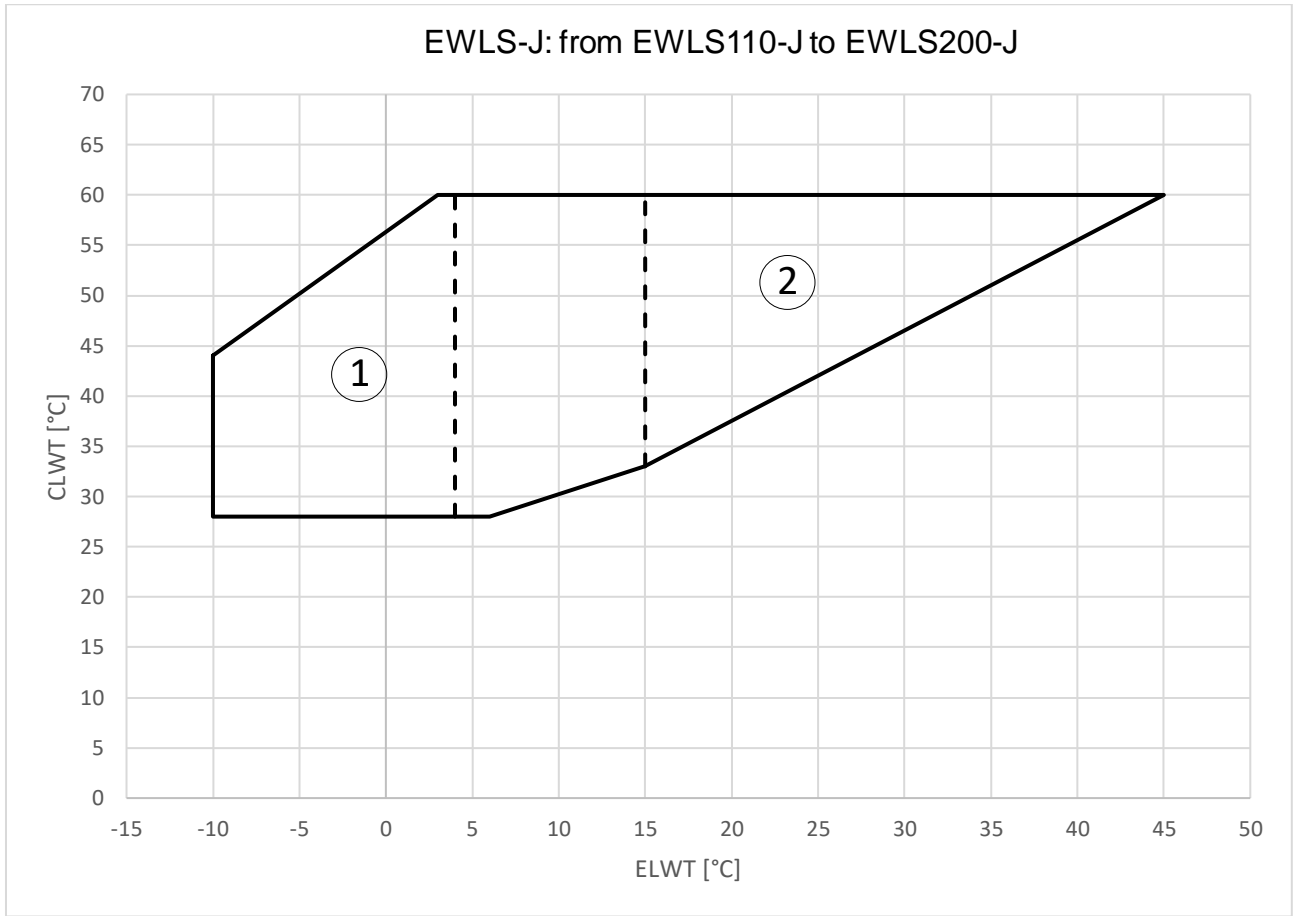

1. Operation with Glycol (below 4°C Evap LWT)
2. Option 189

- **EWLS-J: EWLS240-J and EWLS270-J**



1. Operation with Glycol (below 4°C Evap LWT)

## 5 MECHANICAL INSTALLATION

### 5.1 Safety

All EWWD/H/S - J machines are built in compliance with the main European Directives (Machinery Directive, Low Voltage Directive, Electromagnetic Compatibility Directive, PED Pressure Equipment Directive); be sure to receive, together with the documentation, also the Declaration of Conformity (DoC) of the product to the directives.

Before installation and commissioning of the machinery, the people involved in this activity must have acquired the information necessary to perform these tasks, applying all the information gathered in this manual. In particular:

- the unit must be firmly anchored to the ground when it must not be moved;
- the unit can only be lifted using the lifting points marked in yellow fixed to its base;
- always protect operating personnel with personal protective equipment appropriate to the activities to be performed. The individual devices commonly used are: helmet, glasses, gloves, headphones, safety shoes. Further personal and collective protection devices must be adopted after having carried out an adequate analysis of the specific risks in the relevant area, according to the activities to be carried out.

### 5.2 Moving and lifting

At delivery, the unit should be checked and any damage should be reported immediately to the carrier claims agent.

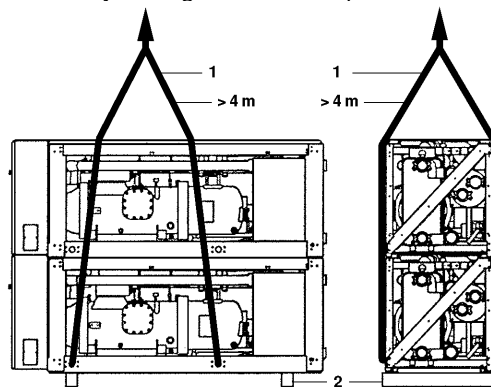

Figure 3- Lifting

When handling the unit, take into account the following:

1. List the unit preferably with a crane and belts in accordance with the instructions on the unit. The length of the ropes (1) to be used for lifting are 4 m minimum each.
2. The unit is shipped with wooden beams (2) under it, these have to be removed before installation.

**NOTE** Try to reduce the drilling in the unit to a minimum. If drilling is unpreventable, remove the iron filling thoroughly in order to prevent surface rust.



**Consult the dimensional drawing for the hydraulic and electrical connection of the units.**

**The overall dimensions of the machine, as well as the weights described in this manual, are purely indicative.**

**The contractual dimensional drawing and the related electrical scheme are delivered to the customer when ordering.**

The equipment, ropes, lifting accessories and handling procedures must comply with local regulations and current regulations.

Use only lifting hooks with locking device. The hooks must be securely fixed before handling.

The lifting ropes, hooks and spacing bars must be strong enough to support the unit safely. Please check the unit weight on the unit nameplate.

The installer has the responsibility to ensure the selection and correct use of the lifting equipment. However, it is advisable to use ropes with a minimum vertical capacity equal to the total weight of the machine.

The machine must be lifted with the utmost attention and care following lifting label instructions; lift the unit very slowly, keeping it perfectly level.

### 5.3 Positioning and assembly

To unpack and place the unit follow the actions listed:

1. Remove the wooden beams from the unit.
2. Install vibration mountings in case of an installation where noise and vibration might be an impediment.
3. Set the unit on a solid and level foundation.

The units are designed for indoor installation and should be installed in a location that meets the following requirements:

1. The foundation is strong enough to support the weight of the unit and the floor is flat to prevent vibration and noise generation.
2. The space around the unit is adequate for servicing.
3. There is no danger of fire due to leakage of inflammable gas.
4. Select the location of the unit in such a way that the sound generated by the unit does not disturb anyone.
5. Ensure that water cannot cause any damage to the location in case it drips out the unit.

**NOTE** Pull-down operation is restricted to one hour maximum.

It is recommended to fix the unit on a concrete base with anchor bolts.

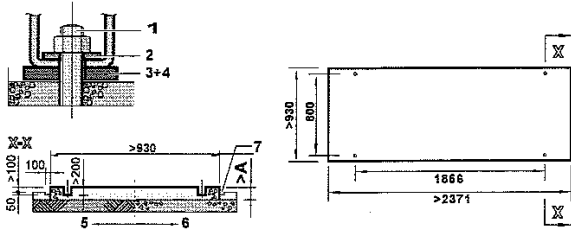

1. Anchor bolt
2. Washer
3. Rubber plate
4. Row cork or rubber sheet
5. Ground
6. Concrete floor
7. Ditch

**Figure 4– Unit Levelling**

- Fix anchor bolts into the concrete foundation. When finally fixing the unit by means of these anchor bolts, make sure that the washers for channel DIN434, and both field supplied rubber plates and field supplied raw cork or rubber sheets for better vibration protection, are installed as indicated.
- The concrete foundation should approximately be 100 mm higher than the floor level for ease of plumbing work and better drain.

Model	A	Anchor bolt	
		Size	Qty
EWWD120J~180J EWLD110J~165J EWWH090J-130J EWLH080J-130J EWWWS120J-180J EWLS110J-170J	300	M20x200	4
EWWD210J~280J EWLD195J~265J EWWH150J-200J EWLH140J-190J EWWWS200J-270J	350	M20x200	4

#### 5.4 Noise and Sound protection

The unit is a source of noise mainly due to rotation of compressors.

The noise level for each model size is listed in sales documentation.

If the unit is correctly installed, operated and maintained the noise emission level do not require any special protection device to operate continuously close to the unit without any risk.

In cases where the installation is subject to compliance with special sound requirements, it may be necessary to use additional noise attenuation devices, it is necessary to isolate the unit from its base with extreme care, correctly applying the anti-vibration elements (supplied as optional). Flexible joints must be installed on the water connections, as well.

#### 5.5 Water piping

Piping must be designed with the lowest number of elbows and the lowest number of vertical changes of direction. In this way, installation costs are reduced considerably, and system performance is improved.

The water system must have:

1. Anti-vibration mountings to reduce transmission of vibrations to the structures.

2. Isolating valves to isolate the unit from the water system during maintenance.
3. To protect the unit, the heat exchanger must be protected against freezing by continuous monitoring of the water flow in the heat exchanger by a flow switch. In most cases, on site, the flow switch is set to generate an alarm only when the water pump turns off and the water flow drops to zero. It is recommended to adjust the flow switch to produce a "Water Leakage Alarm" when the water flow reaches the minimum value of the flow allowable (see table 1); in this case the heat exchanger is protected against freezing and the flow switch can detect the clogging of the water filter.
4. Manual or automatic air venting device at the system highest point and drain device at the system lowest point.
5. Neither the heat exchanger nor the heat recovery device must be positioned at the system's highest point.
6. A suitable device that can maintain the water system under pressure (expansion tank, etc.).
7. Water temperature and pressure indicators to assist the operator during service and maintenance.
8. A filter or device that can remove particles from the fluid. The use of a filter extends the life of the heat exchanger and pump and helps to keep the water system in a better condition. **The water filter must be installed as close as possible to the unit.** If the water filter is installed in another part of the water system, the Installer must guarantee the cleaning of the water pipes between the water filter and the heat exchanger.

Recommended maximum opening for strainer mesh is:

- 0.87 mm (DX S&T)
- 1.0 mm (BPHE)
- 1.2 mm (Flooded)

Precautions for correct use:

9. The heat exchanger has an electrical resistance with a thermostat that ensures protection against water freezing at ambient temperatures as low as -18°C.  
All the other water piping/devices outside the unit must therefore be protected against freezing.
10. The heat recovery device must be emptied of water during the winter season, unless an ethylene glycol mixture in appropriate percentage is added to the water circuit.
11. In case of unit substitution, the entire water system must be emptied and cleaned before the new unit is installed. Regular tests and proper chemical treatment of water are recommended before starting up the new unit.
12. If glycol is added to the water system as anti-freeze protection, pay attention to the fact that suction pressure will be lower, the unit performance will be lower and water pressure drops will be greater. All unit-protection systems, such as anti-freeze, and low-pressure protection will have to be readjusted.
13. Before insulating water piping, check that there are no leaks. The complete hydraulic circuit must be insulated to prevent condensation and reduced refrigeration capacity. Protect the water pipes from frost during winter (using for example a glycol solution or a heating cable).
14. Check that the water pressure does not exceed the design pressure of the water side heat exchangers. Install a safety valve on the water pipe downstream of the heat exchanger.

### 5.5.1 Water piping installation procedure

The units are equipped with a water inlet and water outlet for connection to a chiller water circuit. This circuit must be provided by a licensed technician and must comply with all relevant European and national regulations.



***If air or dirt gets in the water circuit, problems may occur. Therefore, always take into account the following when connecting the water circuit.***

1. ***Use clean pipes only.***
2. ***Hold the pipe end downwards when removing burrs.***
3. ***Cover the pipe end when inserting it through a wall so that no dust and dirt enter***

1. Preparing the unit for connection to the water circuit. A box containing Victaulic® couplings and a filter is delivered with the unit.

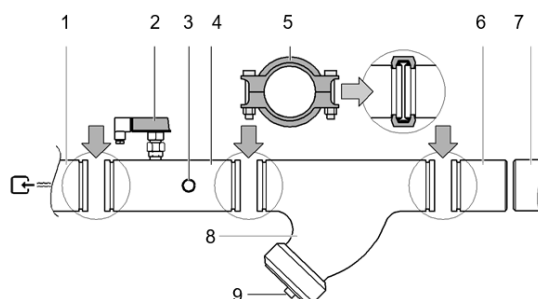

1. Water inlet of the evaporator
2. Flow switch
3. Inlet water sensor
4. Water inlet pipe containing the flow switch and the water inlet temperature sensor
5. Victaulic® coupling
6. Counter pipe

7. Field water pipe circuit
8. Filter
9. Filter and cup

As not to damage the parts of the units during transport, the water inlet pipe with the flow switch and the water inlet temperature sensor and the water outlet pipe with the outlet water temperature sensor, are not factory mounted.

#### Connecting the water inlet pipe containing the flow switch.

The water inlet pipe containing the flow switch is mounted on the side of the water inlet of the evaporator(s) and is pre-insulated. Cut the tie wraps and fix the pipe with the supplied Victaulic® couplings to the evaporator inlet(s).

#### Connecting the water outlet pipe.

The water outlet pipe is mounted on the side of the water outlet of the evaporator and is pre-insulated. Cut the tie wraps and fix the pipe(s) with the supplied Victaulic® couplings to the evaporator outlet(s).

After installation of the water inlet and outlet pipes and as a general rule for other units, it is recommended to check the insertion depth of the water temperature sensors into the connection pipes prior the operation (see figure).

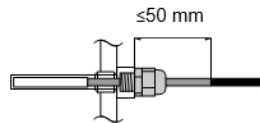

#### Connecting the filter

- The filter kit supplied with the unit must be installed in front of the evaporator water inlet by means of the supplied Victaulic® couplings as shown in the figure. The filter has holes of diameter 1,0 mm and secures the evaporator against clogging.
- Improper installation of the supplied filter will result in severe damage of the equipment (freezing of the evaporator).
- A field supplied blow down port for flushing fluid and accumulated material from inside the filter can be connected on the filter end cap.

#### Connecting the counter pipes

1. Weld the supplied counter pipes to the ends of the water circuit and connect to the unit with the provided Victaulic® couplings.
2. Drain taps must be provided at all low points of the system to permit complete drainage of the circuit during maintenance or in case of shut down. The drain plug is provided to drain the condenser. When doing this, also remove the air plugs (refer to the outlook diagram).
3. Air vent must be provided at all high points of the system. The vents should be located at points which are easily accessible for servicing.
4. Shut-off valves should be provided at the unit so that normal servicing can be accomplished without draining the system.
5. Vibration eliminators in all water piping connected to the chiller are recommended to avoid straining the piping and transmitting vibration and noise.
6. For units in double circuit configuration with common leaving water control (ELWT), be sure to foresee an insertion hole for the additional water temperature sensor. Sensor and sensor holder are optional parts.
7. The insertion hole shall be 1/4" GAS female thread and should be located in the mixed waterflow of the chillers.
8. Make sure that the sensor tip is in the waterflow and that you have a length of straight pipe (L) of at least 10x the pipe diameter (A) before the sensor.

Choose the position of insertion in a way that the cable length of the sensor (10 m) is long enough.

#### 5.5.2 Piping insulation

The complete water circuit, inclusive all piping, must be insulated to prevent condensation and reduction of the cooling capacity.

Protect the water piping against water freezing during winter period (e.g., by using a glycol solution or heater tape).

#### 5.6 Water flow and quality

To assure proper operation of the unit, the water flow through the evaporator must be within the operation range as specified in the table below and a minimum water volume is required in the system.

Model	Minimum water flow [l/s]	Maximum water flow [l/min]
EWWD120J - EWLD110J	5.0	11.2
EWWH090J – EWLH080J	2.6	
EWWS120J – EWLS110J		
EWWD140J - EWLD130J	6.2	12.8
EWWH110J – EWLH100J	3.1	
EWWS140J – EWLS130J		
EWWD150J - EWLD145J	4.4	14.7
EWWH120J – EWLH110J	3.53	
EWWS150J – EWLS150J		
EWWD180J - EWLD165J	5.2	17
EWWH130J – EWLH130J	4	
EWWS180J – EWLS170J		
EWWD210J - EWLD195J	6.1	19.3
EWWH150J – EWLH140J	4.5	
EWWS210J – EWLS200J		
EWWD250J - EWLD235J	8.4	23.7
EWWH180J – EWLH170J	5.7	
EWWS240J – EWLS240J		
EWWD280J - EWLD265J	8.4	26.4
EWWH120J – EWLH190J	5.7	
EWWS270J – EWLS270J		

The minimum water volume v [l] in the system must fulfil the criteria below:

$$V > \left(\frac{Q}{2}\right) \times \left(\frac{T}{C \times \Delta T}\right)$$

Q highest cooling capacity of the unit in lowest capacity step within the range of application (kW)

t antirecycling timer of unit (AREC)/2(s) = 300 s

C specific heat capacity of the fluidum (kJ/kg°C)=4,186 kJ/kg°C for water

ΔT temperature difference between starting and stopping of the compressor:

$$\Delta T = a + 2b + c$$

(for designation of a, b, and c, refer to the operation manual)

**NOTE:** For units in a double circuit configuration, the minimum required water volume in the system must equal the biggest required minimum volume of every individual chiller in the system.

The water quality must be in accordance with the specifications listed the table below

**Table 1 - Acceptable water quality limits**

DAE Water quality requirements	Shell&tube+ Flooded	BPHE
Ph (25 °C)	6.8 ÷ 8.4	7.5 – 9.0
Electrical conductivity [μS/cm] (25°C)	< 800	< 500
Chloride ion [mg Cl- / l]	< 150	< 70 (HP <sup>1</sup> ); < 300 (CO <sup>2</sup> )
Sulphate ion [mg SO42- / l]	< 100	< 100
Alkalinity [mg CaCO3 / l]	< 100	< 200
Total Hardness [mg CaCO3 / l]	< 200	75 ÷ 150
Iron [mg Fe / l]	< 1	< 0.2
Ammonium ion [mg NH4+ / l]	< 1	< 0.5
Silica [mg SiO2 / l]	< 50	NO
Chlorine molecular (mg Cl2/l)	< 5	< 0.5

1: HP = Heat pump;

2: CO = Cooling only





**The water pressure should not exceed the maximum working pressure of 10 bar.**

**Provide adequate safeguards in the water circuit to make sure that the water pressure will never exceed the maximum allowable working pressure.**

## 5.7 Evaporator and recovery exchangers anti-freeze protection

All BPHE are supplied with a thermostatically controlled anti-freeze electrical resistance, which provides adequate anti-freeze protection at temperatures as low as -18°C.

However, unless the heat exchangers are completely empty and cleaned with anti-freeze solution, additional methods should also be used against freezing.

The following protection methods must be considered when designing the system as a whole:

- continuous water flow circulation inside piping and exchangers;
- addition of an appropriate amount of glycol inside the water circuit or, as alternative, an additional heat insulation and heating of exposed piping (internal and external to the unit);
- if the unit does not work during the winter season, emptying and cleaning of the heat exchanger.

It is the responsibility of the installer and/or of local maintenance personnel to ensure that described anti-freeze methods are used. Make sure that appropriate anti-freeze protection is always maintained. Failing to follow the instructions above could result in unit damage.



**Damage caused by freezing is excluded from the warranty, therefore Daikin Applied Europe S.p.A declines all responsibility**

## 5.8 Before Starting



**The unit should not be started, not even for a very short period of time, before the following pre-commissioning checklist is filled out completely.**

tick ✓ when checked	standard steps to go through before starting the unit
<input type="checkbox"/> 1	Check for external damage.
<input type="checkbox"/> 2	Open all <b>shut-off valves</b> .
<input type="checkbox"/> 3	Install <b>main fuses, earth leak detector and main switch</b> . Recommended fuses: aM according to IEC standard 269-2. <i>Refer to the wiring diagram for size.</i>
<input type="checkbox"/> 4	Supply the main voltage and check if it is within the allowable $\pm 10\%$ limits of the nameplate rating. The electrical <b>main power supply</b> should be arranged so, that it can be switched on or off independently of the electrical supply to other items of the plant and equipment in general. <i>Refer to the wiring diagram, terminals L1, L2 and L3.</i>
<input type="checkbox"/> 5	Supply water to the evaporator and verify if <b>waterflow</b> is within the limits as given in the table under "Water charge, flow and quality".
<input type="checkbox"/> 6	The piping must be completely <b>purged</b> . See also chapter "Preparing, checking and connecting the water circuit".
<input type="checkbox"/> 7	Connect the <b>pump contact(s)</b> in series with the contact of the flow switch(es), so that the unit can only come in operation when the water pumps are running, and the water flow is sufficient.
<input type="checkbox"/> 8	Check the <b>oil level</b> in the compressors.
<input type="checkbox"/> 9	Install the <b>filter kit(s) supplied with the unit</b> in front of the evaporator(s) water inlet.
<input type="checkbox"/> 10	Check that all the <b>water sensors</b> are correctly fixed into the heat exchanger (see also the sticker attached to the heat exchanger).

**NOTE** It is necessary to read the operation manual delivered with the unit before operating the unit. It will contribute to understand the operation of the unit and its electronic controller. Close all switch box doors after installation of the unit.

## 6 GUIDELINES FOR REMOTE CONDENSER APPLICATION (EWLD J, EWLH and EWLS versions)

---

Design of remote condenser application, and, in particular, sizing of piping and piping path, is a responsibility of plant designer.

This paragraph is only focused to give suggestion to plant designer, these suggestions have to be weighted with references to application peculiarities.

For remote condenser application, such as air-cooled or evaporative condensers, the chillers are shipped with holding Nitrogen charge. It is important that the unit be kept tightly closed until the remote condenser is installed and piped to the unit.

Chillers are supplied with filter drier, moisture indicator and expansion valve factory mounted as standard.

It is the contractor responsibility to install the interconnection piping, leak test it and the entire system, evacuate the system and supply the refrigerant charge.

All piping must be compliant to the applicable local and state codes.

Use refrigerant grade copper tubing only and isolate the refrigeration lines from building structures to prevent transfer of vibration.

It is important that the discharge lines be looped at the condenser and trapped at the compressor to prevent refrigerant and oil from draining into the compressors; looping the discharge line also provide greater flexibility.

Do not use a saw to remove end caps. This might allow copper chips to contaminate the system. Use a tube cutter or heat to remove caps. When sweating copper joints it is important to flow dry nitrogen through the system prior to charging with refrigerant. This prevents scale formation and the possible formation of an explosive mixture of refrigerant and air. This will also prevent the formation of toxic phosgene gas, which occurs when the refrigerant is exposed to open flame.

Soft solders are not to be used. For copper-to-copper joints use a phos-copper solder with 6% to 8% silver content. A high silver content brazing rod must be used for copper-to-brass or copper-to-steel joints. Only use oxy-acetylene brazing.

After the equipment is correctly installed, leak tested and evacuated, it can be charged with refrigerant and started under the supervision of Daikin authorized technician.

Charge will be added until the liquid line sight glass is clear, with no bubbles flowing into the expansion valve. Total refrigerant charge will depend on the used remote condenser and volume of refrigerant piping

### 6.1 Installation information for condenserless units

#### **This product is factory charged with N2**

The units are equipped with a refrigerant inlet (discharge side) and a refrigerant outlet (liquid side) for the connection to a remote condenser. This circuit must be provided by a licensed technician and must comply with all relevant European and national regulations.

#### **6.1.1 Precautions when handling piping**

If air or dirt gets in the water circuit, problems may occur. Therefore, always take into account the following when connecting the water circuit:

1. Use clean pipes only.
2. Hold the pipe end downwards when removing burrs.
3. Cover the pipe end when inserting it through a wall so that no dust and dirt enter.

The discharge and liquid line must be welded directly to the remote condenser piping. For use of the correct pipe diameter see table of Technical specifications.

Make sure the pipes are filled with N2 during welding in order to protect the pipes against soot.

There should be no blockage (stop valve, solenoid valve) between the remote condenser and the provided liquid injection of the compressor.

#### **6.1.2 Leak test and vacuum drying**

The units were checked for leaks by the manufacturer.

After connection of the piping, a leak test must be performed and the air in the refrigerant piping must be evacuated to a value of 4 mbars absolute by means of a vacuum pump.



***Do not purge the air with refrigerants. Use a vacuum pump to vacuum the installation.***

---

### 6.1.3 Charging the unit

1. Perform an integral pre-start inspection like explained in “BEFORE STARTING”.



**Carefully perform all required procedures like explained in chapters from which is referred to in chapter “BEFORE STARTING”, but do not start the unit. It is also necessary to read the operation manual delivered with the unit. This will contribute to understand the operation of the unit and its electronic controller.**

#### Pre-charge of refrigerant without operation of the unit

2. Use the 1/4” SAE Flare stop valve on the filter drier to pre-charge the unit with the complete calculated pre-charge.
3. Do not operate the compressor for pre-charging, this to avoid compressor damage! After completion of procedure step 2, perform an “initial start” test:
  - a. Start the compressor and wait for the compressor to go through the star/delta. Carefully check during start-up:
    - that compressor is not producing any abnormal noise or vibration;
    - that high pressure rises, and low pressure drops within 10 seconds after to evaluate if the compressor is not operating in reverse due to wrong wiring;
    - that no safeties are activated.
  - b. Stop the compressor after 10 seconds.

#### Fine-tuning of refrigerant charge while unit is in operation

4. Use the 1/4” SAE Flare valve on the suction for fine-tuning of the refrigerant charge and make sure to charge the refrigerant in its liquid state.
  - a. For fine-tuning of the refrigerant charge, the compressor must operate at full load (100%).
  - b. Verify the superheat and subcooling:
    - superheat must be between 3 and 8 K
    - subcooling must be between 3 and 8 K
  - c. Verify the oil sight glass. Level must be within the sight glass.
  - d. Verify the liquid line sight glass. It should be sealed and not indicate moisture in the refrigerant.
  - e. As long as the liquid-line sight glass is not sealed, add refrigerant in steps of 1 Kg and wait until the unit runs in stable conditions. Repeat the complete procedure step 4 until the liquid line sight glass is sealed. The unit must have the time to stabilize which means that this charging has to be done in a smooth way.
5. Note down the superheat and subcooling for future reference.

Fill out the total refrigerant charge on the unit nameplate and on the refrigerant charge label supplied with the product.

**NOTE** Take care for contamination of the remote condenser in order to avoid blocking of the system. It is impossible for the manufacturer to control the contamination of the “foreign” condenser of the installer. The unit has a strict contamination level.

## 6.2 Refrigerant piping design

The system can be configured in any of the main arrangements as shown in Figure 5, Figure 6 and Figure 7. The configuration and its associated elevation, along with the total distance between the chiller and the air-cooled condenser are important factors in determining the liquid line and discharge line sizes. This will also affect the field refrigerant charges. Consequently, there are physical limits that must not be violated if the system is to operate as designed.

1. The total distance between the chiller and the air-cooled condenser should not exceed 60 equivalent meters
2. Liquid line risers must not exceed 3 meters in height from the condenser liquid line connection.
3. Discharge line risers cannot exceed an elevation difference greater than 30 actual meters.

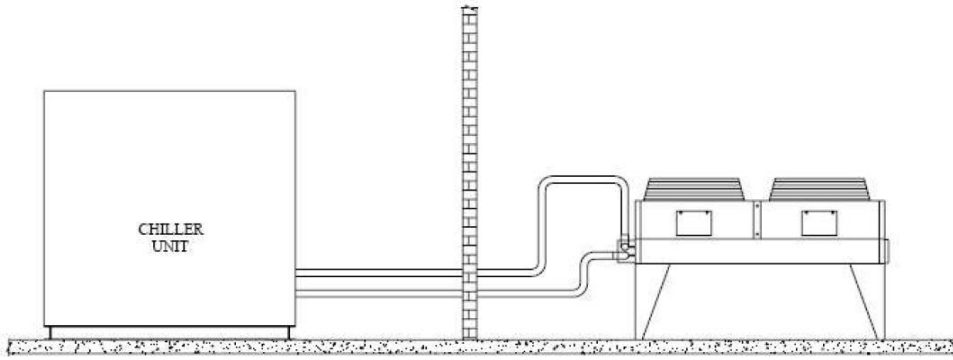

**Figure 5 - Condenser located with no elevation difference**

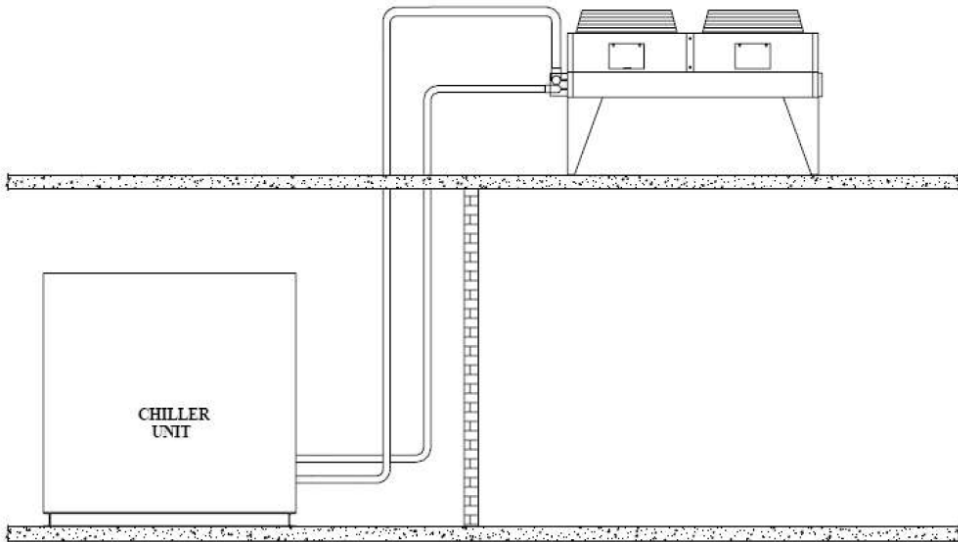

**Figure 6 - Condenser located above the unit**

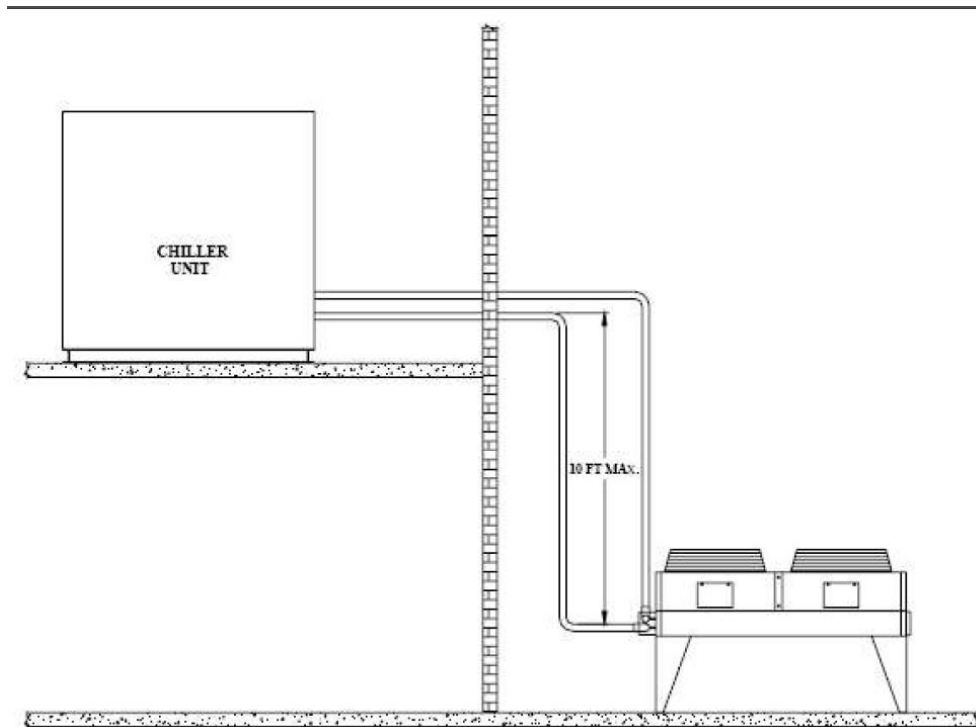

**Figure 7 - Condenser located below the unit**

### 6.2.1 Equivalent line length

To determine the appropriate size for field installed liquid and discharge lines, it is first necessary to establish the equivalent length of pipe for each line. The equivalent length is the actual friction loss from the linear run of pipe plus the added friction loss of elbows, valves, etc. Table 2 shows the equivalent length of pipe for various nonferrous valves and fittings. Follow these steps when calculating line size:

1. Start with an initial approximation of equivalent length by assuming that the equivalent length of pipe is 1.5 times the actual pipe length.
2. Refer to Tables 2 and 3 for a first approximation of line size.
3. Check the line size by calculating the actual equivalent length.

Note: When calculating the equivalent length, do not include piping of the chiller unit. Only field piping must be considered

Line Size OD (Inches)	Angle Valve	Short Radius EL	Long Radius EL
1/4	5.8	0.8	0.6
3/8	7.3	1.2	0.9
1/2	7.3	1.4	1.0
5/8	7.6	1.7	1.2
3/4	7.6	2.0	1.4
7/8	8.5	2.4	1.6
1-1/8	8.8	0.8	0.6
1-3/8	10.1	1.0	0.7
1-5/8	10.4	1.2	0.8
2-1/8	11.9	1.6	1.0
2-5/8	13.4	2.0	1.3
3-1/8	14.3	2.4	1.6

**Figure 8 - Equivalent lengths (in meters)**

### 6.2.2 Liquid line sizing

In designing liquid lines it is important that the liquid reaches the expansion valve without flash gas, since this gas will reduce the valve capacity. Because flashing gas can be caused by pressure drop in the line, the pressure losses due to friction and changes in static head should be kept at minimum.

A check valve must be installed in the liquid line where the ambient temperature can drop below the equipment room temperature to prevent liquid migration to the condenser and to maintain liquid refrigerant in the line for unit startup (if thermostatic expansion valve is used, the check valve also helps to keep liquid pressure high enough to keep the valve closed with compressor off).

A relief valve should be installed between the check valve and the expansion valve.

The liquid line diameter should be as small as possible while maintaining acceptable pressure drop. This is necessary to minimize refrigerant charge. The total length between the chiller unit and the air-cooled condenser must not exceed 60 equivalent meters.

Liquid line risers in the system will require an additional 11.5 kPa pressure drop per meter of vertical rise. When it is necessary to have a liquid line riser, make the vertical run immediately after the condenser before any additional restrictions. The liquid line risers must not exceed 3 meters in height from the condenser liquid line connection (see Figure 22). The liquid line does not have to be pitched.

Liquid lines are not typically insulated. However, if the lines are exposed to solar heat gain or temperatures exceeding 43°C, sub-cooling may be affected. In these situations, insulate the liquid lines.

Reference for liquid line sizing is shown in Table 3. It has to be used for reference only, for circuit working with condensing temperature equal to 55°C and 5°C subcooling at the condenser outlet. Line dimensioning is responsibility of plant designer, use ASHRAE Refrigeration Handbook or other suitable design guide.

**Table 2 – liquid line sizing**

	<b>Circuit Capacity kW</b>	<b>5</b>	<b>10</b>	<b>15</b>	<b>20</b>	<b>25</b>	<b>30</b>	<b>40</b>	<b>50</b>	<b>60</b>
	<b>R134a</b>	300	1-1/8	1-1/8	1-3/8	1-3/8	1-3/8	1-3/8	1-3/8	1-5/8
350		1-1/8	1-3/8	1-3/8	1-3/8	1-3/8	1-3/8	1-5/8	1-5/8	1-5/8
400		1-1/8	1-3/8	1-3/8	1-3/8	1-3/8	1-5/8	1-5/8	1-5/8	1-5/8
450		1-1/8	1-3/8	1-3/8	1-3/8	1-5/8	1-5/8	1-5/8	2-1/8	2-1/8
<b>R1234ze</b>	<b>Circuit Capacity kW</b>	<b>5</b>	<b>10</b>	<b>15</b>	<b>20</b>	<b>25</b>	<b>30</b>	<b>40</b>	<b>50</b>	<b>60</b>
	225	1-1/8	1-1/8	1-3/8	1-3/8	1-3/8	1-3/8	1-3/8	1-5/8	1-5/8
	265	1-1/8	1-3/8	1-3/8	1-3/8	1-3/8	1-3/8	1-5/8	1-5/8	1-5/8
	300	1-1/8	1-3/8	1-3/8	1-3/8	1-3/8	1-5/8	1-5/8	1-5/8	1-5/8
	340	1-1/8	1-3/8	1-3/8	1-3/8	1-5/8	1-5/8	1-5/8	2-1/8	2-1/8
<b>R513A</b>	<b>Circuit Capacity kW</b>	<b>5</b>	<b>10</b>	<b>15</b>	<b>20</b>	<b>25</b>	<b>30</b>	<b>40</b>	<b>50</b>	<b>60</b>
	250	1-1/8	1-1/8	1-3/8	1-3/8	1-3/8	1-3/8	1-3/8	1-5/8	1-5/8
	290	1-1/8	1-3/8	1-3/8	1-3/8	1-3/8	1-3/8	1-5/8	1-5/8	1-5/8
	330	1-1/8	1-3/8	1-3/8	1-3/8	1-3/8	1-5/8	1-5/8	1-5/8	1-5/8
	375	1-1/8	1-3/8	1-3/8	1-3/8	1-5/8	1-5/8	1-5/8	2-1/8	2-1/8

### 6.2.3 Discharge (Hot Gas) Line Sizing

Discharge line size is based on the velocity needed for proper chiller operation handling oil properly and protecting compressor from damage that can result from condensing liquid refrigerant during shutdown.

Total friction loss for discharge line from 20 to 40 kPa is considered good design. Carefully consideration must be given for sizing each section of piping so that gas velocities are sufficient at all operating conditions to carry oil.

If the velocity in a vertical discharge riser is too low, considerable oil can collect in the riser and horizontal header, causing compressor to lose oil and it can result in compressor damage due to lack of oil. When the compressor load (and the gas velocity in the discharge line) increase the oil collected during reduced load can be carried out in a slug back to the compressor causing damage.

Any discharge lines coming into and horizontal header should rise above the centerline of the header.

The discharge lines should pitch downward, in the direction of the hot gas flow, at the rate of 6 mm per meter of horizontal run. This is necessary to move by gravity any oil lying in the header. Oil pockets should be avoided because oil would collect at such points of the compressor can become starved.

If the chiller unit is below condenser, loop the discharge line to at least 2.5 cm above the top of the condenser. A pressure tap valve should be installed at the condenser to facilitate measuring pressure for service.

A relief valve should be installed on the discharge line.

Reference for discharge line sizing is shown in Table 4, Table 5 and Table 6. It has to be used for reference only, for circuit working with

evaporator leaving temperature equal to 7°C and condensing temperature equal to 55°C. Line dimensioning is responsibility of plant designer, use ASHRAE Refrigeration Handbook or other suitable design guide.

**Table 3 - discharge line sizing**

	Circuit Capacity kW	5	10	15	20	25	30	40	50	60
		<b>R134a</b>	300	2-1/8	2-1/8	2-1/8	2-5/8	2-5/8	2-5/8	3-1/8
	350	2-1/8	2-1/8	2-5/8	2-5/8	3-1/8	3-1/8	3-1/8	3-1/8	3-1/8
	400	2-1/8	2-5/8	2-5/8	3-1/8	3-1/8	3-1/8	3-1/8	2x2-5/8	2x2-5/8
	450	2-5/8	2-5/8	2-5/8	3-1/8	3-1/8	3-1/8	2x2-5/8	2x2-5/8	2x2-5/8
<b>R1234ze</b>	Circuit Capacity kW	5	10	15	20	25	30	40	50	60
	225	2-1/8	2-1/8	2-1/8	2-5/8	2-5/8	2-5/8	3-1/8	3-1/8	3-1/8
	265	2-1/8	2-1/8	2-5/8	2-5/8	3-1/8	3-1/8	3-1/8	3-1/8	3-1/8
	300	2-1/8	2-5/8	2-5/8	3-1/8	3-1/8	3-1/8	3-1/8	2x2-5/8	2x2-5/8
	340	2-5/8	2-5/8	2-5/8	3-1/8	3-1/8	3-1/8	2x2-5/8	2x2-5/8	2x2-5/8
<b>R513A</b>	Circuit Capacity kW	5	10	15	20	25	30	40	50	60
	250	2-1/8	2-1/8	2-1/8	2-5/8	2-5/8	2-5/8	3-1/8	3-1/8	3-1/8
	290	2-1/8	2-1/8	2-5/8	2-5/8	3-1/8	3-1/8	3-1/8	3-1/8	3-1/8
	330	2-1/8	2-5/8	2-5/8	3-1/8	3-1/8	3-1/8	3-1/8	2x2-5/8	2x2-5/8
	375	2-5/8	2-5/8	2-5/8	3-1/8	3-1/8	3-1/8	2x2-5/8	2x2-5/8	2x2-5/8

**6.2.4 Oil charge**

In remote condenser application the oil charge into the compressor has to take into account that a percentage of oil around 1% is usually mixed into the refrigerant, so some oil has to be added to the standard charge if the refrigerant charge exceed the standard charge of the unit. What is important, during the unit operation, is that the oil level in the oil separator is not lower than the ¼ of the upper sightglass.

The compressor of the EWLD and Liquid Receiver version units are shipped with their proper charge of oil. The refrigerant circuits must not remain open to the air for more than 15 minutes. If this happens you need to replace the oil charge and the oil filter as described in the "Procedure to replace oil filter" of this manual.

## 7 ELECTRICAL INSTALLATION

---

### 7.1 General specifications

Refer to the specific wiring diagram for the unit you have bought. Should the wiring diagram not be on the unit or should it have been lost, please contact your manufacturer representative, who will send you a copy. In case of discrepancy between wiring diagram and electrical panel/cables, please contact the manufacturer representative.



***All electrical connections to the unit must be carried out in compliance with laws and regulations in force.  
All installation, management and maintenance activities must be carried out by qualified personnel.  
There is a risk of electric shock.***

---

This unit includes non-linear loads such as inverters, which have a natural current leakage to earth. If an Earth Leakage Detector is installed upstream the unit, a type B device with a minimum threshold of 300 mA must be used.



***Before any installation and connection works, the unit must be switched off and secured. Since this unit includes inverters, the intermediate circuit of the capacitors remains charged with high voltage for a short period of time after being switched off.  
Do not operate to the unit before 20 minutes after the unit has been switched off.***

---

Electrical equipment is capable of operating correctly in the intended ambient air temperature. For very hot environments and for cold environments, additional measures are recommended (contact the manufacturer representative). The electrical equipment is capable of operating correctly when the relative humidity does not exceed 50 % at a maximum temperature of +40 °C. Higher relative humidities are permitted at lower temperatures (for example 90% at 20 °C). Harmful effects of occasional condensation shall be avoided by design of the equipment or, where necessary, by additional measures (contact the manufacturer representative).

This product complies with EMC standards for industrial environments. Therefore it is not intended for use in residential areas, e.g. installations where the product is connected to a low voltage public distribution system. Should this product need to be connected to a low voltage public distribution system, specific additional measures will have to be taken to avoid interference with other sensitive equipment.

### 7.2 Electrical supply

The electrical equipment can operate correctly with the conditions specified below:

<b>Voltage</b>	Steady state voltage: 0,9 to 1,1 of nominal voltage
<b>Frequency</b>	0,99 to 1,01 of nominal frequency continuously 0,98 to 1,02 short time
<b>Armonics</b>	Harmonic distortion not exceeding 10 % of the total r.m.s. voltage between live conductors for the sum of the 2nd through to the 5 <sup>th</sup> harmonic. An additional 2 % of the total r.m.s. voltage between live conductors for the sum of the 6th through to the 30th harmonic is permissible.
<b>Voltage unbalance</b>	Neither the voltage of the negative sequence component nor the voltage of the zero sequence component in three-phase supplies exceeding 3 % of the positive sequence component
<b>Voltage interruption</b>	Supply interrupted or at zero voltage for not more than 3 ms at any random time in the supply cycle with more than 1 s between successive interruptions.
<b>Voltage dips</b>	Voltage dips not exceeding 20% of the peak voltage of the supply for more than one cycle with more than 1 s between successive dips.

### 7.3 Electric connections

Provide an electrical circuit to connect the unit. It must be connected to the copper cables with an adequate section relative to the plate absorption values and according to the current electrical standards.

Daikin Applied Europe S.p.A. declines all responsibility for an inadequate electrical connection.



***The connections to the terminals must be made with copper terminals and cables, otherwise overheating or corrosion may occur at the connection points with the risk of damaging the unit. The electrical connection must be carried out by qualified personnel, in compliance with the laws in force.  
There is a risk of electric shock.***

---



The power supply to the unit must be set up in such a way that it can be switched on or off independently from that of other system components and other equipment in general, by means of a general switch.

The electrical connection of the panel must be carried out maintaining the correct sequence of the phases. Refer to the specific wiring diagram for the unit you have bought. Should the wiring diagram not be on the unit or should it have been lost, please contact your manufacturer representative, who will send you a copy. In case of discrepancy between wiring diagram and electrical panel/cables, please contact the manufacturer representative.



**Do not apply torque, tension or weight to the main switch terminals. Power line cables must be supported by appropriate systems.**

To avoid interference, all control wires must be connected separately from the power cables. To do this, use several electrical passage ducts.

Simultaneous single and three-phase loads and phase unbalance can cause ground losses of up to 150 mA during normal unit operation. If the unit includes devices that generate higher harmonics, such as an inverter or phase cut, ground losses can increase to much higher values, about 2 A.

The protections for the power supply system must be designed according to the values mentioned above. A fuse must be present on each phase and, where provided for by the national laws of the country of installation, a leak detector to earth. This product complies with EMC (Electromagnetic Compatibility) standards for industrial environments. Therefore, it is not intended for use in residential areas, e.g. installations where the product is connected to a low voltage public distribution system. Should this product need to be connected to a low voltage public distribution system, specific additional measures will have to be taken to avoid interference with other sensitive equipment.



**Before any electrical connection work to the compressor motor and / or the fans, make sure that the system is switched off and the main switch of the unit is open. Failure to observe this rule could result in serious personal injury.**

## 7.4 Cable requirements

The cables connected to the circuit breaker must respect the insulation distance in the air and the surface isolation distance between the active conductors and the earth, according to IEC 61439-1 table 1 and 2, and to the local national laws.

The cables connected to the main switch must be tightened using a pair of keys and respecting the unified clamping values, relative to the quality of the screws of the washers and nuts used.

Connect the earth conductor (yellow / green) to the PE ground terminal.

The equipotential protection conductor (earth conductor) must have a section according to table 1 of EN 60204-1 Point 5.2, shown below.

**Table 1 - Table 1 of EN60204-1 Point 5.2**

Section of the copper phase conductors feeding the equipment S [mm <sup>2</sup> ]	Minimum cross-section of the external copper protection conductor Sp [mm <sup>2</sup> ]
S ≤ 16	S
16 < S ≤ 35	16
S > 35	S/2

In any case, the equipotential protection conductor (earth conductor) must have a cross section of at least 10 mm<sup>2</sup>, in accordance with point 8.2.8 of the same standard.

## 7.5 Phase unbalance

In a three-phase system, the excessive imbalance between the phases is the cause of the engine overheating. The maximum permitted voltage unbalance is 3%, calculated as follows:

$$\text{Unbalance \%} = \frac{(V_x - V_m) * 100}{V_m}$$

where:

V<sub>x</sub> = phase with greater unbalance

V<sub>m</sub> = average of the tensions

Example: the three phases measure 383, 386 and 392 V respectively. The average is:

$$\frac{383 + 386 + 392}{3} = 387 \text{ V}$$

The unbalance percentage is:

$$\frac{(392 - 387) * 100}{387} = \mathbf{1.29\%}$$

less than the maximum allowed (3%).

## **8 OPERATION**

---

### **8.1 Operator's responsibilities**

It is essential that the operator is appropriately trained and becomes familiar with the system before operating the unit. In addition to reading this manual, the operator must study the microprocessor operating manual and the wiring diagram in order to understand start-up sequence, operation, shutdown sequence and operation of all the safety devices.

During the unit's initial start-up phase, a technician authorized by the manufacturer is available to answer any questions and to give instructions as to the correct operating procedures.

The operator must keep a record of operating data for every installed unit. Another record should also be kept of all the periodical maintenance and servicing activities.

If the operator notes abnormal or unusual operating conditions, he is advised to consult the technical service authorized by the manufacturer.

## 9 MAINTENANCE

### 9.1 Routine maintenance

This unit must be maintained by qualified technicians. Before beginning any work on the system the personnel shall assure that all security precautions have been taken.

Personel working on the electrical or the refrigeration components must be authorized, trained and fully qualified.

Maintenance and repair requiring the assistance of other skilled personnel should be carried out under the supervision of the person competent in the use of flammable refrigerants. Any person conducting servicing or maintenance on a system or associated parts of the equipment should be competent according to EN 13313.

**Persons working on refrigerating systems with flammable refrigerants should have competence in safety aspects of flammable refrigerant handling supported by evidence of appropriate training.**

Always protect the operating personnel with personal protective equipment appropriate for the tasks to be performed. Common individual devices are: Helmet, goggles, gloves, caps, safety shoes. Additional individual and group protective equipment should be adopted after an adequate analysis of the specific risks in the area of relevance, according to the activities to be performed.

<b>electrical components</b>	Never work on any electrical components, until the general supply to the unit has been cut using the disconnect switch(es) in the control box. The frequency variators used are equipped with capacitor batteries with a discharge time of 20 minutes; after disconnecting power wait 20 minutes before opening the control box.
<b>refrigerating system</b>	<p>The following precautions should be taken before working on the refrigerant circuit:</p> <ul style="list-style-type: none"> <li>- obtain permit for hot work (if required);</li> <li>- ensure that no flammable materials are stored in the work area and that no ignition sources are present anywhere in the work area;</li> <li>- ensure that suitable fire extinguishing equipment is available;</li> <li>- ensure that the work area is <b>properly ventilated</b> before working on the refrigerant circuit or before welding, brazing or soldering work;</li> <li>- ensure that the leak detection equipment being used is non-sparking, adequately sealed or intrinsically safe;</li> <li>- ensure that all maintenance staff have been instructed.</li> </ul> <p>The following procedure should be followed before working on the refrigerant circuit:</p> <ol style="list-style-type: none"> <li>1. remove refrigerant (specify the residual pressure);</li> <li>2. purge circuit with <b>inert gas</b> (e.g. nitrogen);</li> <li>3. evacuate to a pressure of 0,3 (abs.) bar (or 0,03 MPa);</li> <li>4. purge again with <b>inert gas</b> (e.g. nitrogen);</li> <li>5. open the circuit.</li> </ol> <p>The area should be checked with an appropriate refrigerant detector prior to and during any hot work to make the technician aware of a potentially flammable atmosphere.</p> <p>If compressors or compressor oils are to be removed, it should be ensured that it has been evacuated to an acceptable level to ensure that there is no flammable refrigerant remaining within the lubricant.</p> <p><b>Only refrigerant recovery equipment designed for use with flammable refrigerants should be employed.</b></p> <p>If the national rules or regulations permit the refrigerant to be drained, this should be done safely, using a hose, for example, through which the refrigerant is discharged into the outside atmosphere in a safe area. It should be ensured that an inflammable explosive refrigerant concentration cannot occur in the vicinity of an ignition source or penetrate into a building under any circumstance.</p> <p>In the case of refrigerating systems with an indirect system, the heat-transfer fluid should be checked for the possible presence of refrigerant.</p> <p>After any repair work, the safety devices, for example refrigerant detectors and mechanical ventilation systems, should be checked and the results recorded.</p> <p>It should be ensured that any missing or illegible label on components of the refrigerant circuit is replaced.</p> <p>Sources of ignition should not be used when searching for a refrigerant leak.</p>

Neglecting unit maintenance in these environments, could degrade all parts of the units (compressors, frames, pipes, etc..) with negative effect on performances and functionality.



## 10 SERVICE AND LIMITED WARRANTY

---

All units are factory-tested and guaranteed for 12 months as of the first start-up or 18 months as of delivery.

These units have been developed and constructed according to high quality standards ensuring years of failure-free operation. It is important, however, to ensure proper and periodical maintenance in accordance with all the procedures listed in this manual and with good practice of machines maintenance.

We strongly advise stipulating a maintenance contract with a service authorized by the manufacturer in order to ensure efficient and problem-free service, thanks to the expertise and experience of our personnel.

It must also be taken into consideration that the unit requires maintenance also during the warranty period.

It must be borne in mind that operating the unit in an inappropriate manner, beyond its operating limits or not performing proper maintenance according to this manual can void the warranty.

Observe the following points in particular, in order to conform to warranty limits:

1. The unit cannot function beyond the specified limits
2. The electrical power supply must be within the voltage limits and without voltage harmonics or sudden changes.
3. The three-phase power supply must not have an unbalance between phases exceeding 3%. The unit must stay turned off until the electrical problem has been solved.
4. No safety device, either mechanical, electrical or electronic must be disabled or overridden.
5. The water used for filling the water circuit must be clean and suitably treated. A mechanical filter must be installed at the point closest to the evaporator inlet.
6. Unless there is a specific agreement at the time of ordering, the evaporator water flow rate must never be above 120% and below 50% of the nominal flow rate.

## 11 PERIODIC CHECKS AND COMMISSIONING OF PRESSURE EQUIPMENT

---

The units are included in category II → III of the classification established by the European Directive 2014/68/EU (PED).

For chillers belonging to this category, some local regulations require a periodic inspection by an authorized agency. Please check with your local requirements.

## 12 DISPOSAL

---

The unit is made of metal, plastic and electronic parts. All of these components must be disposed of in accordance with local disposal laws and if in scope with the national laws implementing the Directive 2012/19/EU (RAEE).

Lead batteries must be collected and sent to specific waste collection centers.

Avoid the escape of refrigerant gases into the environment by using suitable pressure vessels and tools for transferring the fluids under pressure. This operation must be carried out by competent personnel in refrigeration systems and in compliance with the laws in force in the country of installation.



### 13 IMPORTANT INFORMATION REGARDING THE REFRIGERANT USED

This product contains fluorinated greenhouse gases. Do not vent gases into the atmosphere.

Refrigerant type: R134a / R1234ze / R513A

GWP(1) value: 1430 / 7 / 631

(1)GWP = global warming potential

The refrigerant quantity necessary for standard operation is indicated on the unit name plate.

Periodic inspections for refrigerant leaks may be required depending on European or local legislation. Please contact your local dealer for more information.

#### 13.1 Factory and Field charged units instructions

The refrigerant system will be charged with fluorinated greenhouse gases, and the factory charge(s) are recorded on the label, shown below, which is adhered inside the electrical panel.

Fill in with indelible ink the refrigerant charge label supplied with the product as following instructions:

- Any refrigerant charge for each circuit (1; 2; 3) added during commissioning
- the total refrigerant charge (1 + 2 + 3)
- **calculate the greenhouse gas emission with the following formula:**

$$GWP * total\ charge\ [kg]/1000$$

- a Contains fluorinated greenhouse gases
- b Circuit number
- c Factory charge
- d Field charge
- e Refrigerant charge for each circuit (according to the number of circuits)
- f Total refrigerant charge
- g Total refrigerant charge (Factory + Field)
- h **Greenhouse gas emission** of the total refrigerant charge expressed as tonnes of CO2 equivalent
- m Refrigerant type
- n GWP = Global Warming Potential
- p Unit serial number



**In Europe, the greenhouse gas emission of the total refrigerant charge in the system (expressed as tonnes CO2 equivalent) is used to determine the maintenance intervals. Follow the applicable legislation.**

For more information email [info@daikinapplied.uk](mailto:info@daikinapplied.uk) or visit [www.daikinapplied.uk](http://www.daikinapplied.uk)

For all Daikin Applied UK,  
Daikin Applied Service &  
Spares enquiries call us on:  
**0345 565 2700**



Daikin Europe N.V. participates in the Eurovent Certified Performance programme for Liquid Chilling Packages and Hydronic Heat Pumps, Fan Coil Units and Variable Refrigerant Flow systems. Check ongoing validity of certificate:  
[www.eurovent-certification.com](http://www.eurovent-certification.com)

The present publication is drawn up by way of information only and does not constitute an offer binding upon Daikin Europe N.V. Daikin Europe N.V. has compiled the content of this publication to the best of its knowledge. No express or implied warranty is given for the completeness, accuracy, reliability or fitness for particular purpose of its content and the products and services presented therein. Specifications are subject to change without prior notice. Daikin Europe N.V. explicitly rejects any liability for any direct or indirect damage, in the broadest sense, arising from or related to the use and/or interpretation of this publication. All content is copyrighted by Daikin Europe N.V.

