

Packaged air-cooled  
water chillers and  
packaged reversible air  
to water heatpumps

# Installation manual

EWAQ-ACV3 (009, 010, 011)  
EWYQ-ACV3 (009, 010, 011)

EWAQ-ACW1 (009, 011, 013)  
EWYQ-ACW1 (009, 011, 013)

Refrigerant: R410A

Code	4PW51587-1A
Date	

	↙	↘	↗	↖	↕	A	B1	B2	C	D1	D2	E	L1/L2	
	✓						≥100							
	✓		✓	✓		≥100	≥100		≥100					
	✓				✓		≥100				≤500	≥1000		
	✓		✓	✓	✓	≥150	≥150		≥150		≤500	≥1000		
		✓									≥500			
		✓			✓				≤500		≥500		≥1000	
	✓	✓				L1<L2	≥100			≥500				
						L2<L1	≥100			≥500				
						L1<L2	L1≤H	≥250	≤500		≥750		≥1000	0<L1≤1/2H
	✓	✓			✓	H<L1	L1≤H						0<L1≤1/2H	
					L2<L1	L2≤H	≥100			≥1000	≥500	≥1000	0<L2≤1/2H	
					H<L2	≥200							1/2H<L2≤H	
					H<L2	L2≤H								
	✓		✓	✓		≥200	≥300		≥1000					
	✓		✓	✓	✓	≥200	≥300		≥1000		≤500	≥1000		
		✓									≥1000			
		✓			✓				≤500	≥1000		≥1000		
						L1<L2	≥300			≥1000				
						L2<L1	≥250			≥1500			0<L2≤1/2H	
							≥300						1/2H<L2≤H	
						L1<L2	L1≤H	≥300	≤500		≥1000		≥1000	0<L1≤1/2H
	✓	✓			✓	H<L1	L1≤H						1/2H<L1≤H	
						L2<L1	L2≤H	≥250			≥1500	≤500	≥1000	0<L2≤1/2H
					H<L2	≥300							1/2H<L2≤H	
					H<L2	L2≤H								

1

V3

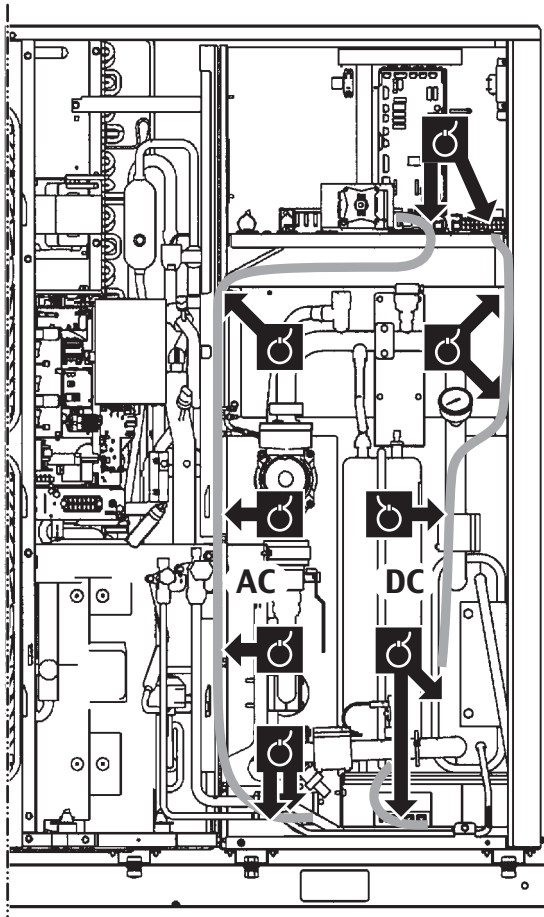

W1

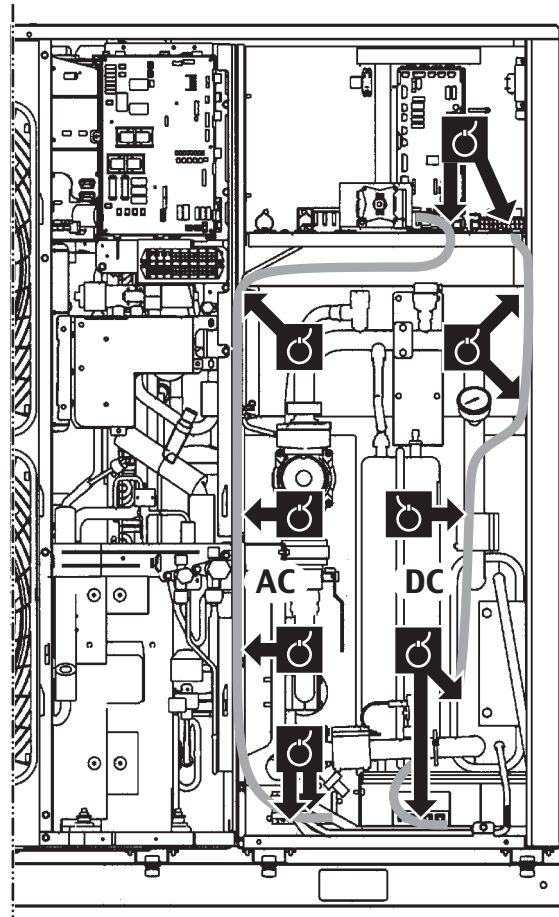

2



**CONTENTS**

	Page
Introduction .....	1
General information .....	1
Scope of this manual .....	1
Model identification .....	2
Accessories .....	2
Accessories supplied with the unit .....	2
Safety considerations .....	2
Before installation .....	3
Important information regarding the refrigerant used .....	3
Selecting installation site .....	4
Selecting a location in cold climates .....	4
Precautions on installation .....	4
Installation method for prevention of falling over .....	5
Installation servicing space .....	5
Typical application examples .....	6
Application 1 .....	6
Application 2 .....	6
Overview of the unit .....	7
Opening the unit .....	7
Main components .....	7
Water pipework .....	8
Charging water .....	10
Piping insulation .....	10
Field wiring .....	11
Specifications of standard wiring components .....	13
Installation of the digital controller .....	15
Start-up and configuration .....	16
Pump operation configuration .....	16
Initial start-up at low outdoor ambient temperatures .....	16
Pre-operation checks .....	16
Powering up the unit .....	17
Failure diagnosis at the moment of first installation .....	17
Setting the pump speed .....	17
Field settings .....	18
Field settings table .....	21
Test run and final check .....	22
Test run operation (manual) .....	22
Final check .....	22
Maintenance .....	22
Chiller unit .....	22
Digital controller .....	23
Troubleshooting .....	23
General guidelines .....	23
General symptoms .....	23
Error codes .....	24
Technical specifications .....	25
General .....	25
Electrical specifications .....	25



READ THESE INSTRUCTIONS CAREFULLY BEFORE INSTALLATION. KEEP THIS MANUAL IN A HANDY PLACE FOR FUTURE REFERENCE.

IMPROPER INSTALLATION OR ATTACHMENT OF EQUIPMENT OR ACCESSORIES COULD RESULT IN ELECTRIC SHOCK, SHORT-CIRCUIT, LEAKS, FIRE OR OTHER DAMAGE TO THE EQUIPMENT. BE SURE ONLY TO USE ACCESSORIES MADE BY DAIKIN WHICH ARE SPECIFICALLY DESIGNED FOR USE WITH THE EQUIPMENT AND HAVE THEM INSTALLED BY A PROFESSIONAL.

IF UNSURE OF INSTALLATION PROCEDURES OR USE, ALWAYS CONTACT YOUR DAIKIN DEALER FOR ADVICE AND INFORMATION.

The English text is the original instruction. Other languages are translations of the original instructions.

**INTRODUCTION**

**General information**

Thank you for purchasing this Daikin inverter chiller.

This unit is designed for outdoor installation and used for both heating and cooling applications. The unit is designed to be combined with fan coil units or air handling units for air conditioning purposes.

**Heat pump and cooling only versions**

This chiller range consists of 2 main versions: a heat pump (EWYQ) version and a cooling only (EWAQ) version, available in 6 standard sizes:

- V3: 9, 10, and 11 kW (single phase)
- W1: 9, 11, and 13 kW (3 phase)

**Options**

- Remote alarm kit EKRP1HB
- Heater tape option OP10

Both versions are also available with a heater tape option (OP10) for protecting internal water pipework at cold outdoor temperatures.

**Connection to a benefit kWh rate power supply**

This equipment allows for connection to benefit kWh rate power supply delivery systems. Full control of the unit will remain possible only in case the benefit kWh rate power supply is of the type that power supply is not interrupted. Refer to "[Connection to a benefit kWh rate power supply](#)" on page 14 for more details.

**Scope of this manual**

This manual describes the procedures for unpacking, installing and connecting all EWA/YQ models, as well as instructions for maintenance and troubleshooting of the unit.

## Model identification

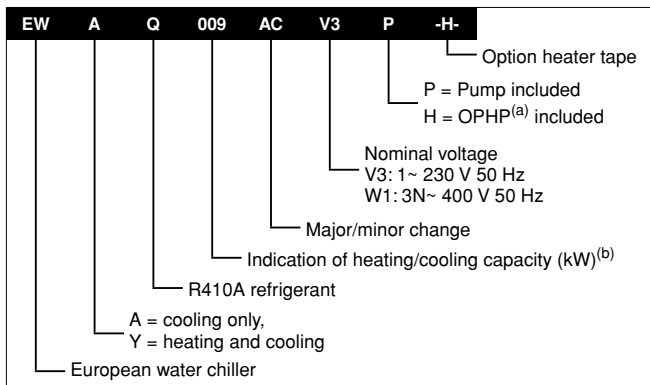

(a) OPHP = High ESP pump.

(b) Please see "Technical specifications" on page 25 for exact values.

## ACCESSORIES

### Accessories supplied with the unit

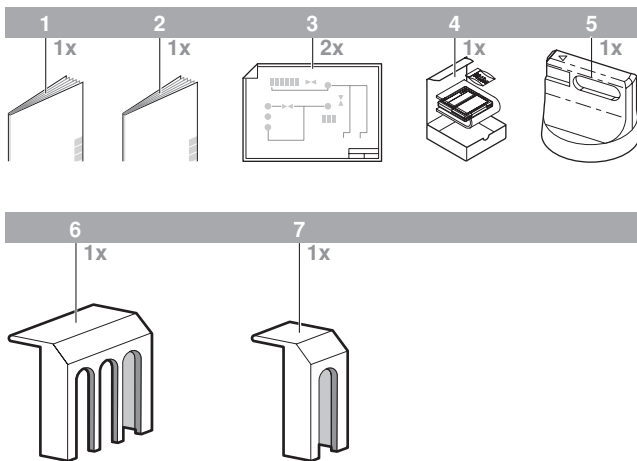

- 1 Installation manual
- 2 Operation manual
- 3 Wiring diagram sticker (inside unit cover doors 1 and 2)
- 4 User interface kit (digital remote controller, 4 fixing screws and 2 plugs)
- 5 Main switch handle
- 6 Protection cap
- 7 Protection cap (only for W1 models)

## SAFETY CONSIDERATIONS

The precautions listed here are divided into the following two types. Both cover very important topics, so be sure to follow them carefully.



### WARNING

If the warning is not observed, it may cause serious casualties.

### CAUTION

If the caution is not observed, it may cause injury or damage to the equipment.

### Warning

- For use of units in applications with temperature alarm settings it is advised to foresee a delay of 10 minutes for signalling the alarm in case the alarm temperature is exceeded. The unit may stop for several minutes during normal operation for "defrosting of the unit" or when in "thermostat-stop" operation.
- Ask your dealer or qualified personnel to carry out installation work. Do not install the machine by yourself.  
Improper installation may result in water leakage, electric shocks or fire.
- Perform installation work in accordance with this installation manual.  
Improper installation may lead to water leakage, electric shocks or fire.
- Be sure to use only the specified accessories and parts for installation work.  
Failure to use the specified parts may result in water leakage, electric shocks, fire, or the unit falling.
- Install the unit on a foundation that can withstand its weight.
- Insufficient strength may result in the fall of equipment and causing injury.
- Carry out the specified installation work in consideration of strong winds, typhoons, or earthquakes.  
Improper installation work may result in accidents due to fall of equipment.
- Make certain that all electrical work is carried out by qualified personnel according to the local laws and regulations and this installation manual, using a separate circuit.  
Insufficient capacity of the power supply circuit or improper electrical construction may lead to electric shocks or fire.
- Make sure that all wiring is secure, using the specified wires and ensuring that external forces do not act on the terminal connections or wires.  
Incomplete connection or fixing may cause a fire.
- When wiring the power supply, form the wires so that the frontside panel can be securely fastened.  
If the frontside panel is not in place, overheat of the terminals, electric shocks or a fire may be caused.
- After completing the installation work, check to make sure that there is no leakage of refrigerant gas.
- Before touching electric terminal parts, turn off power switch.
- Live parts can be easily touched by accident.  
Never leave the unit unattended during installation or servicing when the service panel is removed.
- Never directly touch any accidental leaking refrigerant. This could result in severe wounds caused by frostbite.

## Caution

- Earth the unit.  
Earthing resistance should be according to national regulations  
Do not connect the earth wire to gas or water pipes, lightning conductor or telephone earth wire.  
Incomplete earthing may cause electric shocks.
- 
- Gas pipe.  
Ignition or explosion may occur if the gas leaks.
  - Water pipe.  
Hard vinyl tubes are not effective earths.
  - Lightning conductor or telephone earth wire.  
Electric potential may rise abnormally if struck by a lightning bolt.
  - Be sure to install an earth leakage circuit breaker.  
Failure to install an earth leakage circuit breaker may cause electric shocks and fire.
  - Install the power wire at least 1 meter away from televisions or radios to prevent image interference or noise.  
(Depending on the radio waves, a distance of 1 meter may not be sufficient to eliminate the noise.)
  - Do not rinse the unit. This may cause electric shocks or fire.
  - Do not install the unit in places such as the following:
    - Where there is mist of mineral oil, oil spray or vapour.  
Plastic parts may deteriorate, and cause them to fall out or water to leak.
    - Where corrosive gas, such as sulphurous acid gas, is produced.  
Corrosion of copper pipes or soldered parts may cause the refrigerant to leak.
    - Where there is machinery which emits electromagnetic waves.  
Electromagnetic waves may disturb the control system, and cause malfunction of the equipment.
    - Where flammable gases may leak, where carbon fiber or ignitable dust is suspended in the air or where volatile flammables, such as thinner or gasoline, are handled.  
Such gases may cause a fire.
    - Where the air contains high levels of salt such as that near the ocean.
    - Where voltage fluctuates a lot, such as that in factories.
    - In vehicles or vessels.
    - Where acidic or alkaline vapour is present.

## BEFORE INSTALLATION

### Installation

- Be sure to confirm the model name and the serial no. of the outer (front) plates when attaching/detaching the plates to avoid mistakes.
- When closing the service panels, take care that the tightening torque does not exceed 4.1 N·m.
- In case ambient temperatures below 0°C are expected, countermeasures need to be taken to prevent the water in the unit from freezing. In such cases, we recommend to install the heater tape option OP10 or we advise to put glycol in the system. See "[Protecting the water circuit against freezing](#)" on page 10. It is also allowed to drain the water from the system when longer periods of standstill are expected.

### Model

EWAQ and EWYQ units include optional special equipment (insulation, heater tape,...) to ensure good operation in areas where low ambient temperature can occur together with high humidity conditions. In such conditions the units may experience problems with severe ice build up on the aircooled coil. In case such conditions are expected, the heater tape option OP10 must be installed instead.

- Possible options

Model	OP10 <sup>(a)</sup>	OPHP <sup>(b)</sup>
EWA/YQ_AC*P	—	—
EWA/YQ_AC*P-H-	Factory mounted	—
EWA/YQ_AC*H	—	Factory mounted
EWA/YQ_AC*H-H-	Factory mounted	Factory mounted

(a) Heater tape option OP10  
(b) High ESP pump

### Handling

Due to relatively large dimensions and high weight, the handling of the unit is only to be done by means of lifting tools with slings. These slings can be fitted into specially for this purpose foreseen sleeves at the base frame.



- To avoid injury, do not touch the air inlet or aluminium fins of the unit.
- Do not use the grips in the fan grills to avoid damage.

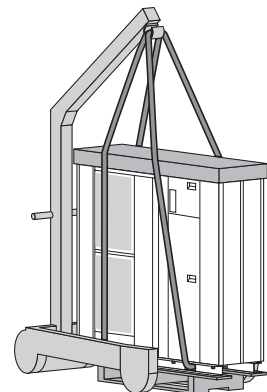

## IMPORTANT INFORMATION REGARDING THE REFRIGERANT USED

This product contains fluorinated greenhouse gases covered by the Kyoto Protocol. Do not vent gases into the atmosphere.

Refrigerant type: R410A

GWP<sup>(1)</sup> value: 1975

<sup>(1)</sup> GWP = global warming potential

The refrigerant quantity is indicated on the unit name plate

## SELECTING INSTALLATION SITE



- Make sure to provide for adequate measures in order to prevent that the unit be used as a shelter by small animals.
- Small animals making contact with electrical parts can cause malfunctions, smoke or fire. Please instruct the customer to keep the area around the unit clean.

- 1 Select an installation site where the following conditions are satisfied and that meets with your customer's approval.
  - Places which are well-ventilated.
  - Places where the unit does not bother next-door neighbours.
  - Safe places which can withstand the unit's weight and vibration and where the unit can be installed level.
  - Places where there is no possibility of flammable gas or product leak.
  - The equipment is not intended for use in a potentially explosive atmosphere.
  - Places where servicing space can be well ensured.
  - Places where the units' piping and wiring lengths come within the allowable ranges.
  - Places where water leaking from the unit cannot cause damage to the location (e.g. in case of a blocked drain pipe).
  - Places where the rain can be avoided as much as possible.

- 2 When installing the unit in a place exposed to strong wind, pay special attention to the following.

Strong winds of 5 m/sec or more blowing against the unit's air outlet causes short circuit (suction of discharge air), and this may have the following consequences:

- Deterioration of the operational capacity.
- Frequent frost acceleration in heating operation.
- Disruption of operation due to rise of high pressure.
- When a strong wind blows continuously on the face of the unit, the fan can start rotating very fast until it breaks.

Refer to the figures for installation of this unit in a place where the wind direction can be foreseen.

- Turn the air outlet side toward the building's wall, fence or screen.

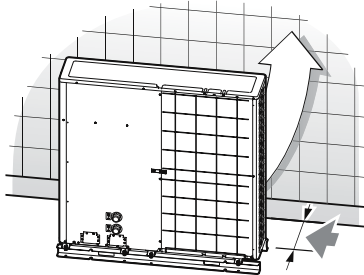

Make sure there is enough room to do the installation

- Set the outlet side at a right angle to the direction of the wind.

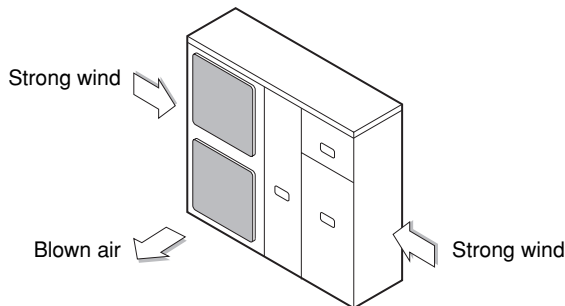

- 3 Prepare a water drainage channel around the foundation, to drain waste water from around the unit.
- 4 If the water drainage of the unit is not easy, please build up the unit on a foundation of concrete blocks, etc. (the height of the foundation should be maximum 150 mm).

- 5 If you install the unit on a frame, please install a waterproof plate within 150 mm of the underside of the unit in order to prevent the invasion of water from the lower direction.
- 6 When installing the unit in a place frequently exposed to snow, pay special attention to elevate the foundation as high as possible.
- 7 If you install the unit on a building frame, please install a waterproof plate (field supply)(within 150 mm of the underside of the unit). (See figure).

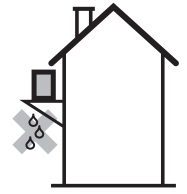

## Selecting a location in cold climates

Refer to "Model" on page 3.



### CAUTION

When operating the unit in a low outdoor ambient temperature, be sure to follow the instructions described below.

- To prevent exposure to wind, install the unit with its suction side facing the wall.
- Never install the unit at a site where the suction side may be exposed directly to wind.
- To prevent exposure to wind, install a baffle plate on the air discharge side of the unit.
- In heavy snowfall areas it is very important to select an installation site where the snow will not affect the unit. If lateral snowfall is possible, make sure that the heat exchanger coil is not affected by the snow (if necessary construct a lateral canopy).



- 1 Construct a large canopy.
- 2 Construct a pedestal. Install the unit high enough off the ground to prevent burying in snow.

## PRECAUTIONS ON INSTALLATION

- Check the strength and level of the installation ground so that the unit will not cause any operating vibration or noise after installation.
- In accordance with the foundation drawing in the figure, fix the unit securely by means of the foundation bolts. (Prepare four sets of M12 foundation bolts, nuts and washers each which are available on the market.)
- It is best to screw in the foundation bolts until their length are 20 mm from the foundation surface.

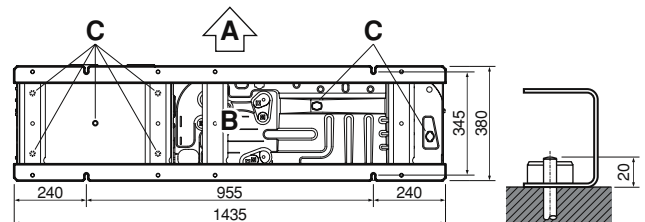

- A Discharge side
- B Bottom view (mm)
- C Drain hole

## Installation method for prevention of falling over

If it is necessary to prevent the unit from falling over, install as shown in the figure.

- prepare all 4 wires as indicated in the drawing
- unscrew the top plate at the 4 locations indicated A and B
- put the screws through the nooses and screw them back tight

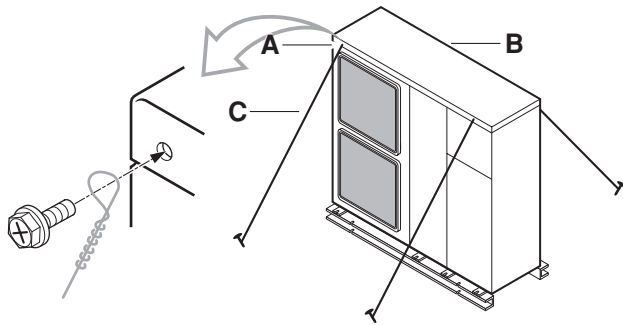

- A Location of the 2 fixation holes on the front side of the unit
- B Location of the 2 fixation holes on the rear side of the unit
- C Wires: field supply

## Installation servicing space

The numerical figures used in the figures represent the dimensions in mm.

(Refer to "Precautions on installation" on page 4)

### Precaution

(A) In case of non-stacked installation (See figure 1)

	Suction side obstacle	✓	Obstacle is present
	Discharge side obstacle	1	In these cases, close the bottom of the installation frame to prevent the discharged air from being bypassed
	Left side obstacle		
	Right side obstacle	2	In these cases, only 2 units can be installed.
	Top side obstacle	✗	This situation is not allowed

**NOTE** Minimum distance B1 in figure 1 mentions the space required for correct operation of the unit. Required space for servicing though is 300 mm.

(B) In case of stacked installation

1. In case obstacles exist in front of the outlet side.

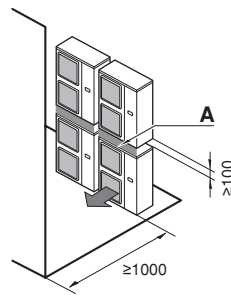

2. In case obstacles exist in front of the air inlet.

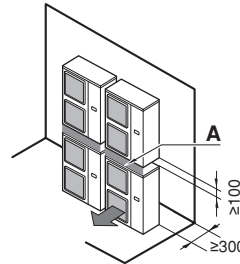

Do not stack more than one unit.

About 100 mm is required as the dimension for laying the upper unit's drain pipe. Get the portion A sealed so that air from the outlet does not bypass.

(C) In case of multiple-row installation (for roof top use, etc.)

1. In case of installing one unit per row.

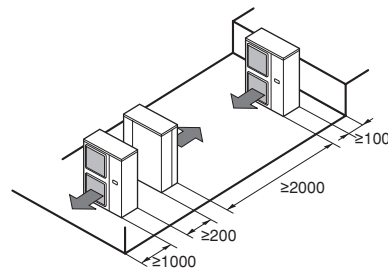

2. In case of installing multiple units (2 units or more) in lateral connection per row.

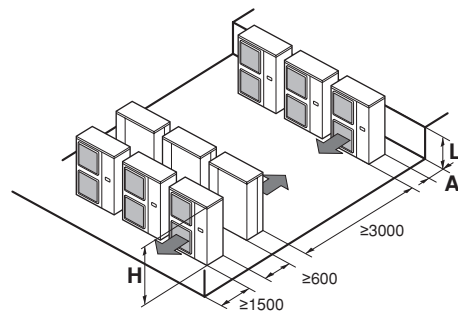

Relation of dimensions of H, A and L are shown in the table below.

	L	A
L ≤ H	0 < L ≤ 1/2H	250
	1/2H < L	300
H < L	Installation not allowed	



## TYPICAL APPLICATION EXAMPLES

The application examples given below are for illustration purposes only.

### Application 1

Cooling and heating application (without room thermostat)

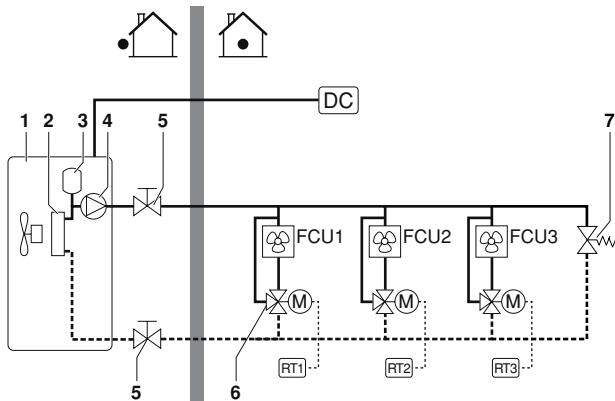

- |                                  |  |
|----------------------------------|--|
| 1 Reversible heat pump           | 7 Bypass valve                               |
| 2 Plate heat exchanger           | <b>FCU1..3</b> Fan coil unit (field supply)  |
| 3 Expansion vessel               | <b>DC</b> Digital controller                 |
| 4 Pump                           | <b>RT1..3</b> Room thermostat (field supply) |
| 5 Shut-off valve                 |  |
| 6 Motorised valve (field supply) |  |

The digital controller (DC) is installed indoors and allows the user to turn the unit (1) ON or OFF, to select between cooling and heating mode (only in case of a heat pump model) and to set the water temperature. When the unit is turned on, it will provide water at the set temperature to the fan coil units (FCU1..3).

### Application 2

Cooling and heating application with a room thermostat suitable for cooling/heating changeover connected to the unit.

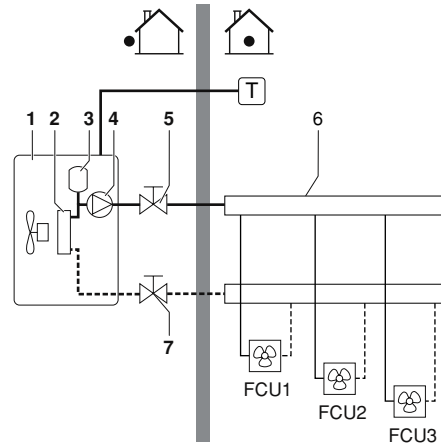

- |                            |  |
|----------------------------|--|
| 1 Reversible heat pump     | 7 Shut-off valve   |
| 2 Plate heat exchanger     | <b>FCU1..3</b> Fan coil unit (field supply)  |
| 3 Expansion vessel         | <b>T</b> Room thermostat or room thermostat with cooling/heating switch (field supply) |
| 4 Pump                     |  |
| 5 Shut-off valve           |  |
| 6 Collector (field supply) |  |

- Pump operation and heating and cooling (cooling and heating application with a room thermostat suitable for cooling/heating changeover connected to the unit)

According to the season, the customer will select cooling or heating on the room thermostat (T). This selection is not possible by operating the user interface.

When cooling/heating is requested by the room thermostat (T), the pump will start operating and the unit will switch to "cooling mode"/"heating mode". The unit will start operating to achieve the target leaving cold/hot water temperature.

The ON/OFF setting of the heating/cooling operation is done by the room thermostat and cannot be done by the user interface on the unit.



Make sure to connect the thermostat wires to the correct terminals (see ["Connection of the thermostat cable" on page 13](#)).

# OVERVIEW OF THE UNIT

## Opening the unit

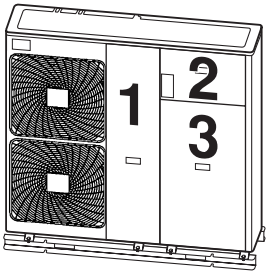

- Door 1 gives access to the compressor compartment and electrical parts
- Door 2 gives access to the electrical parts of the hydraulic compartment
- Door 3 gives access to the hydraulic compartment

**!** Switch off all power supply — i.e. unit power supply — before removing doors 1 and 2.

**!** Parts inside the unit can be hot.

## Main components

### Hydraulic compartment (door 3)

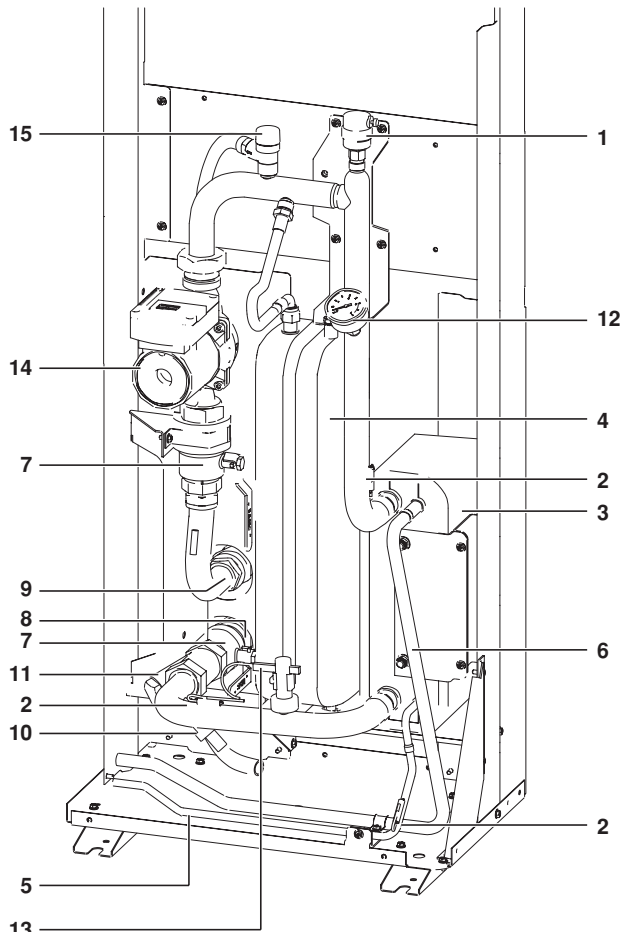

- 1. Air purge valve  
Remaining air in the water circuit will be automatically removed via the air purge valve.
- 2. Temperature sensors  
Three temperature sensors determine the water and refrigerant temperature at various points in the water circuit.

- 3. Heat exchanger
- 4. Expansion vessel (10 l)
- 5. Refrigerant liquid connection
- 6. Refrigerant gas connection
- 7. Shut-off valves

The shut-off valves on the water inlet connection and water outlet connection allow isolation of the unit water circuit side from the residential water circuit side. This facilitates draining and filter replacement of the unit.

- 8. Water inlet connection
- 9. Water outlet connection
- 10. Drain and fill valve
- 11. Water filter

The water filter removes dirt from the water to prevent damage to the pump or blockage of the evaporator. The water filter must be cleaned on a regular basis. See "Maintenance" on page 22.

- 12. Manometer  
The manometer allows readout of the water pressure in the water circuit.
- 13. Flow switch  
The flow switch checks the flow in the water circuit and protects the heat exchanger against freezing and the pump against damage.
- 14. Pump  
The pump circulates the water in the water circuit.
- 15. Pressure relief valve  
The pressure relief valve prevents excessive water pressure in the water circuit by opening at 3 bar and discharging some water.

### Functional diagram of hydraulic compartment (door 3)

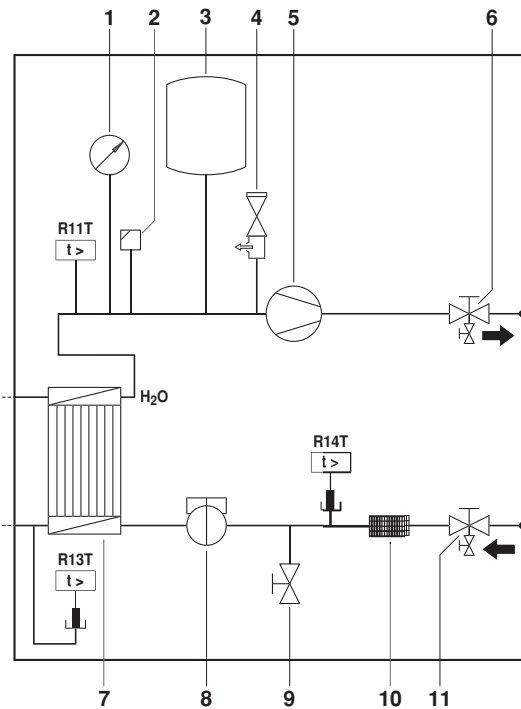

- |   |                             |      |   |
|---|-----------------------------|------|---|
| 1 | Manometer                   | 8    | Flow switch                                 |
| 2 | Air purge valve             | 9    | Drain/fill valve                            |
| 3 | Expansion vessel            | 10   | Filter                                      |
| 4 | Pressure relief valve       | 11   | Shut-off valve water inlet with drain valve |
| 5 | Pump                        |      |   |
| 6 | Shut-off valve water outlet | R11T | Temperature sensors                         |
| 7 | Heat exchanger              | R13T |   |
|   |                             | R14T |   |

## Switch box main components (door 2)

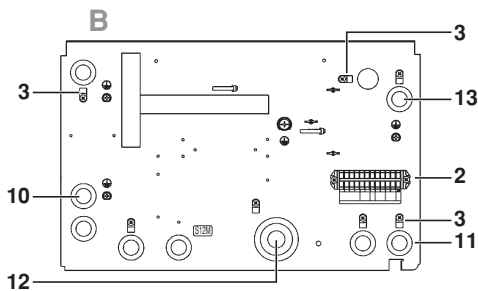
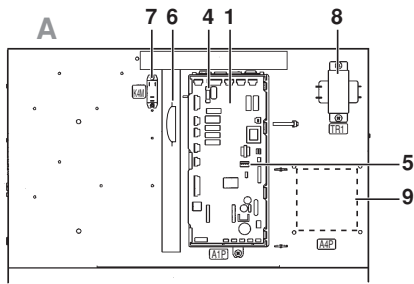
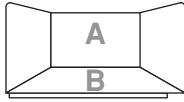

1. Main PCB  
The main PCB (Printed Circuit Board) controls the functioning of the unit.
2. Terminal blocks  
The terminal blocks allow easy connection of field wiring.
3. Cable tie mountings  
The cable tie mountings allow to fix the field wiring with cable ties to the switch box to ensure strain relief.
4. PCB fuse FU1
5. DIP switch SS2  
The DIP switch SS2 provides 4 toggle switches to configure certain installation parameters.
6. Pump fuse FU2 (in line fuse)
7. Pump relay K4M
8. Transformer TR1
9. A4P  
Remote alarm input/output PCB (only for installations with remote alarm kit).
10. Conduit hole to pass through the main power supply cable to the compressor module.
11. Conduit hole to pass through the thermistor cable and user interface cable (and benefit kWh rate cable).
12. Conduit hole to pass through the installation power supply wiring.
13. Conduit hole to pass through optional input/output PCB connection wiring.

**NOTE** The electrical wiring diagram can be found on the inside of the switch box cover.



## Water pipework



In case of a power supply failure or pump operating failure, drain the system (as suggested in the figure below).

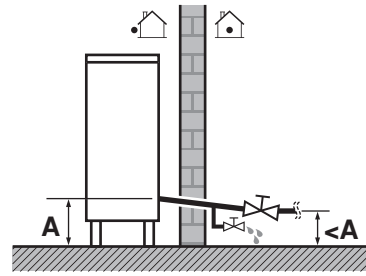

When water is at standstill inside the system, freezing up is very likely to happen and damaging the system in the process.

## Checking the water circuit

The units are equipped with a water inlet and water outlet for connection to a water circuit. This circuit must be provided by a licensed technician and must comply with all relevant European and national regulations.



The unit is only to be used in a closed water system. Application in an open water circuit can lead to excessive corrosion of the water piping.

Before continuing the installation of the unit, check the following points:

- The maximum water pressure is 3 bar.
- Drain taps must be provided at all low points of the system to permit complete drainage of the circuit during maintenance.  
A drain valve is provided in the unit to drain the water from the unit water system.
- Air vents must be provided at all high points of the system. The vents should be located at points which are easily accessible for servicing. An automatic air purge is provided inside the unit. Check that this air purge valve is not tightened too much so that automatic release of air in the water circuit remains possible.
- Take care that the components installed in the field piping can withstand the water pressure.

## Checking the water volume and expansion vessel pre-pressure

The unit is equipped with an expansion vessel of 10 litre which has a default pre-pressure of 1 bar.

To assure proper operation of the unit, the pre-pressure of the expansion vessel might need to be adjusted and the minimum and maximum water volume must be checked.

- 1 Check that the total water volume in the installation, excluding the internal water volume of the unit, is 20 l minimum. Refer to "Technical specifications" on page 25 to know the internal water volume of the unit.

### Operation range

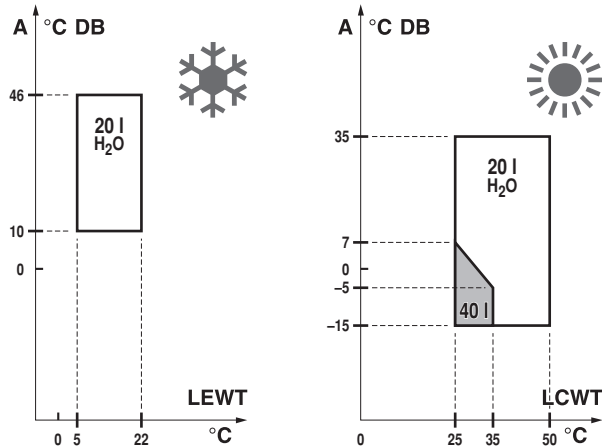

- A** Outdoor temperature  
**°C DB** °C dry bulb  
**LEWT** Leaving evaporator water temperature  
**LCWT** Leaving condenser water temperature



In most applications this minimum water volume will have a satisfying result.

In critical processes or in rooms with a high heat load though, extra water volume might be required (40 l).

- 2 Using the table below, determine if the expansion vessel pre-pressure requires adjustment.
- 3 Using the table and instructions below, determine if the total water volume in the installation is below the maximum allowed water volume.

Installation height difference <sup>(a)</sup>	Water volume	
	≤280 l (EWAQ)	>280 l (EWYQ)
≤7 m	No pre-pressure adjustment required.	Actions required: • pre-pressure must be decreased, calculate according to "Calculating the pre-pressure of the expansion vessel" • check if the water volume is lower than maximum allowed water volume (use graph below)
>7 m	Actions required: • pre-pressure must be increased, calculate according to "Calculating the pre-pressure of the expansion vessel" • check if the water volume is lower than maximum allowed water volume (use graph below)	Expansion vessel of the unit too small for the installation.

(a) Installation height difference: height difference (m) between the highest point of the water circuit and the unit. If the unit is located at the highest point of the installation, the installation height is considered 0 m.

## Calculating the pre-pressure of the expansion vessel

The pre-pressure ( $P_g$ ) to be set depends on the maximum installation height difference ( $H$ ) and is calculated as below:

$$P_g = (H/10 + 0.3) \text{ bar}$$

## Checking the maximum allowed water volume

To determine the maximum allowed water volume in the entire circuit, proceed as follows:

- 1 Determine for the calculated pre-pressure ( $P_g$ ) the corresponding maximum water volume using the graph below.
- 2 Check that the total water volume in the entire water circuit is lower than this value.

If this is not the case, the expansion vessel inside the unit is too small for the installation.

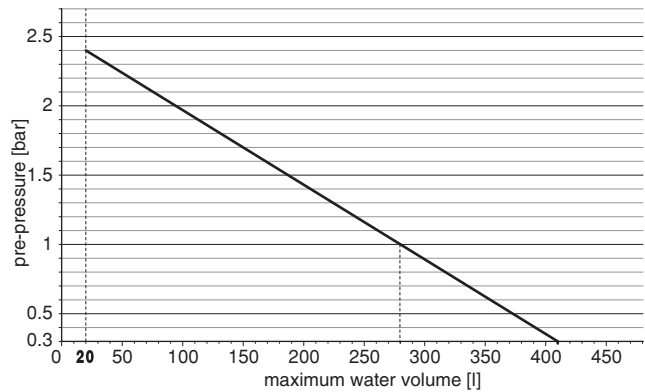

- pre-pressure = pre-pressure  
 maximum water volume = maximum water volume

### Example 1

The unit is installed 5 m below the highest point in the water circuit. The total water volume in the water circuit is 100 l.

In this example, no action or adjustment is required.

### Example 2

The unit is installed at the highest point in the water circuit. The total water volume in the water circuit is 350 l.

Result:

- Since 350 l is higher than 280 l, the pre-pressure must be decreased (see table above).
- The required pre-pressure is:  
 $P_g = (H/10 + 0.3) \text{ bar} = (0/10 + 0.3) \text{ bar} = 0.3 \text{ bar}$
- The corresponding maximum water volume can be read from the graph: approximately 410 l.
- Since the total water volume (350 l) is below the maximum water volume (410 l), the expansion vessel suffices for the installation.

## Setting the pre-pressure of the expansion vessel

When it is required to change the default pre-pressure of the expansion vessel (1 bar), keep in mind the following guidelines:

- Use only dry nitrogen to set the expansion vessel pre-pressure.
- Inappropriate setting of the expansion vessel pre-pressure will lead to malfunction of the system. Therefore, the pre-pressure should only be adjusted by a licensed installer.

## Connecting the water circuit

Water connections must be made in accordance with the outlook diagram delivered with the unit, respecting the water in- and outlet.



Be careful not to deform the unit piping by using excessive force when connecting the piping. Deformation of the piping can cause the unit to malfunction.

If air, moisture or dust gets in the water circuit, problems may occur. Therefore, always take into account the following when connecting the water circuit:

- Use clean pipes only.
- Hold the pipe end downwards when removing burrs.
- Cover the pipe end when inserting it through a wall so that no dust and dirt enter.
- Use a good thread sealant for the sealing of the connections. The sealing must be able to withstand the pressures and temperatures of the system.
- When using non-brass metallic piping, make sure to insulate both materials from each other to prevent galvanic corrosion.
- Because brass is a soft material, use appropriate tooling for connecting the water circuit. Inappropriate tooling will cause damage to the pipes.

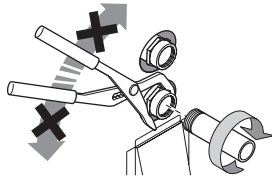

- The unit is only to be used in a closed water system. Application in an open water circuit can lead to excessive corrosion of the water piping.
- Never use Zn-coated parts in the water circuit. Excessive corrosion of these parts may occur as copper piping is used in the unit's internal water circuit.

## Protecting the water circuit against freezing

Frost can damage the unit. For this reason, in colder climates the water circuit can be protected by means of a heater tape option (OP10) or by adding glycol to the water.

### In case of heater tape

Check that the unit has the option heater tape installed (factory mounted). Units with option heater tape have the possibility to install an extra heatertape to protect the waterpipe outside the unit against freezing. (Field supply, maximum 200 W, connections must be made on terminals 5/6 inside the switchbox).



For the heater tape to operate, power to the unit must be provided and the main isolator switch must be on. For this reason never disconnect power and never turn off the main isolator switch for a long time during cold periods!

### In case of glycol

Depending on the expected lowest outdoor temperature, make sure the water system is filled with a weight concentration of glycol as mentioned in the table below.

Minimum outdoor temperature	Ethylene glycol	Propylene glycol
-5°C	10%	15%
-10°C	25%	25%
-15°C	35%	35%



## Corrosion of the system due to presence of glycol

Uninhibited glycol will turn acidic under the influence of oxygen. This process is accelerated by presence of copper and at higher temperatures. The acidic uninhibited glycol attacks metal surfaces and forms galvanic corrosion cells that cause severe damage to the system.

It is therefore of extreme importance:

- that the water treatment is correctly executed by a qualified water specialist;
- that a glycol with corrosion inhibitors is selected to counteract acids formed by the oxidation of glycols;
- that no automotive glycol is used because their corrosion inhibitors have a limited lifetime and contain silicates which can foul or plug the system;
- that galvanized piping is not used in glycol systems since its presence may lead to the precipitation of certain components in the glycol's corrosion inhibitor;
- that it has to be made sure the glycol is compatible with the used materials in the system.

### NOTE



Be aware of the hygroscopic property of glycol: it absorbs moisture from its environment.

Leaving the cap off the glycol container causes the concentration of water to increase. The glycol concentration is then lower than assumed. And in consequence, freezing can happen after all.

Preventive actions must be taken to ensure minimal exposure of the glycol to air.

Also refer to "Checks before initial start-up" on page 16.

## Charging water

- 1 Connect the water supply to a drain and fill valve (see "Main components" on page 7).
- 2 Make sure the automatic air purge valve is open (at least 2 turns).
- 3 Fill with water until the manometer indicates a pressure of approximately 2.0 bar. Remove air in the circuit as much as possible using the air purge valves. Air present in the water circuit might cause malfunctioning.

### NOTE



- During filling, it might not be possible to remove all air in the system. Remaining air will be removed through the automatic air purge valves during first operating hours of the system. Additional filling with water afterwards might be required.

- The water pressure indicated on the manometer will vary depending on the water temperature (higher pressure at higher water temperature).

However, at all times water pressure should remain above 0.3 bar to avoid air entering the circuit.

- The unit might dispose some excessive water through the pressure relief valve.

## Piping insulation

The complete water circuit, inclusive all piping, must be insulated to prevent condensation during cooling operation and reduction of the cooling and heating capacity as well as prevention of freezing of the outside water piping during winter time. The thickness of the sealing materials must be at least 13 mm with  $\lambda = 0.036$  in order to prevent freezing on the outside water piping.

If the temperature is higher than 30°C and the humidity is higher than RH 80%, then the thickness of the sealing materials should be at least 20 mm in order to avoid condensation on the surface of the sealing.

## Field wiring

### WARNING

- Switch off the power supply before making any connections.
- All field wiring and components must be installed by a licensed electrician and must comply with relevant European and national regulations.
- The field wiring must be carried out in accordance with the wiring diagram supplied with the unit and the instructions given below.
- Be sure to use a dedicated power supply. Never use a power supply shared by another appliance.
- Be sure to establish an earth. Do not earth the unit to a utility pipe, surge absorber, or telephone earth. Incomplete earth may cause electrical shock.
- Be sure to install an earth leakage protector (30 mA). Failure to do so may cause electrical shock.

### Precautions on electrical wiring work

#### High voltage

To avoid electrical shock, make sure to disconnect the power supply 1 minute or more before servicing the electrical parts. Even after 1 minute, always measure the voltage at the terminals of main circuit capacitors or electrical parts and, before touching, make sure that those voltages are 50 V DC or less.

- Use only copper wires.
- Never squeeze bundled cables into a unit.
- Fix cables so that cables do not make contact with the pipes (especially on high pressure side).
- Secure the electrical wiring with cable ties as shown in figure 2 so that it does not come in contact with the piping, particularly on the high-pressure side.
- Make sure no external pressure is applied to the terminal connectors.
- For W1
  - Make sure to connect power supply cables in normal phase. If connected in reverse phase, the remote controller indicates "U!" and the equipment cannot operate. Change any two of the three power supply cables (L1, L2, L3) to correct phase.
- As this unit is equipped with an inverter, installing a phase advancing capacitor not only will deteriorate power factor improvement effect, but also may cause capacitor abnormal heating accident due to high-frequency waves. Therefore, never install a phase advancing capacitor.
- When installing the earth leakage circuit breaker make sure that it is compatible with the inverter (resistant to high frequency electrical noise) to avoid unnecessary opening of the earth leakage circuit breaker.

**NOTE** The earth leakage circuit breaker must be a high-speed type breaker of 30 mA (<0.1 s).

## Overview

The illustration below gives an overview of the required field wiring between several parts of the installation. Refer also to "Typical application examples" on page 6.

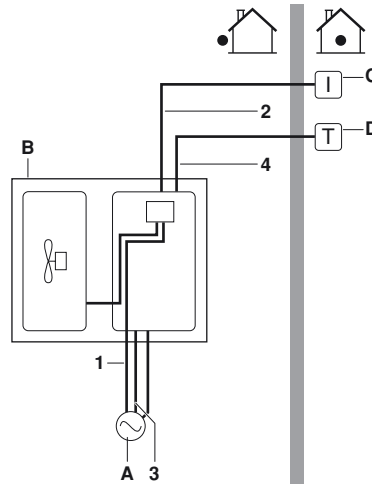

- A Single power supply for unit
- B Unit
- C User interface
- D Room thermostat (field supply, optional)

Item	Description	AC/DC	Required number of conductors	Maximum running current
1	Power supply cable for unit	AC	2+GND (V3) 4+GND (W1)	(a)
2	User interface cable	DC	2	100 mA <sup>(b)</sup>
3	Benefit kWh rate power supply cable (voltage free contact)	DC	2	100 mA <sup>(b)</sup>
4	Room thermostat cable	AC	3 or 4	100 mA <sup>(b)</sup>

- (a) Refer to nameplate on the unit  
(b) Minimum cable section 0.75 mm<sup>2</sup>

### Internal wiring - Parts table

Refer to the internal wiring diagram supplied with the unit (on the inside of the switch box cover). The abbreviations used are listed below.

#### Door 1 compressor compartment and electrical parts

##### V3 models only

- A1P..... Main PCB
- A2P..... Inverter PCB
- A3P..... Noise filter PCB
- A4P..... PCB
- BS1~BS4..... Push button switch
- C1~C4..... Capacitor
- DS1..... DIP switch
- E1HC..... Crankcase heater
- F1U,F3U,F4U .. Fuse 6.3 A T 250 V
- F6U..... Fuse 5.0 A T 250 V
- H1P~H7P ..... Orange LED service monitor (A2P)  
H2P: prepare, test = flickering  
H2P: malfunction detection = light up
- HAP (A1P)..... Green LED service monitor
- K1R..... Magnetic relay (Y1S)
- K4R..... Magnetic relay (E1HC)
- K10R,K11R..... Magnetic relay
- L1R..... Reactor
- M1C..... Motor (compressor)
- M1F..... Motor (upper fan)
- M2F..... Motor (lower fan)
- PS..... Switching power supply
- R1,R2..... Resistor
- R1T..... Thermistor (air)

R2T..... Thermistor (discharge)  
 R3T..... Thermistor (suction)  
 R4T..... Thermistor (heat exchanger)  
 R5T..... Thermistor (heat exchanger middle)  
 R6T..... Thermistor (liquid)  
 R10T..... Thermistor (fin)  
 RC..... Signal receiver circuit  
 S1NPH..... Pressure sensor  
 S1PH..... High pressure switch  
 TC..... Signal transmission circuit  
 V1R..... Power module  
 V2R,V3R..... Diode module  
 V1T..... IGBT  
 X1M..... Power supply terminal strip  
 Y1E..... Electronic expansion valve  
 Y1S..... Solenoid valve (4-way valve)  
 Z1C~Z3C..... Noise filter (ferrite core)  
 Z1F~Z4F..... Noise filter

**W1 models only**

A1P..... PCB  
 A2P..... Inverter PCB  
 A3P..... Noise filter PCB  
 BS1~BS4..... Push button switch  
 C1~C4..... Capacitor  
 DS1..... DIP switch  
 E1HC..... Crankcase heater  
 F1U,F2U..... Fuse 31.5 A 500 V  
 F3U~F6U..... Fuse 6.3 A T 250 V  
 F7U..... Fuse 5.0 A T 250 V  
 H1P~H7P..... Orange LED service monitor (A1P)  
 HAP (A1P)..... Green LED service monitor  
 HAP (A2P)..... Green LED service monitor  
 K1M,K2M..... Magnetic contactor  
 K1R (A1P)..... Magnetic relay (Y1S)  
 K1R (A2P)..... Magnetic relay  
 K2R (A1P)..... Magnetic relay (Y2S)  
 K3R (A1P)..... Magnetic relay (E1HC)  
 L1R~L3R..... Reactor  
 L4R..... Reactor for outdoor fan motor  
 M1C..... Motor (compressor)  
 M1F..... Motor (upper fan)  
 M2F..... Motor (lower fan)  
 PS..... Switching power supply  
 R1~R4..... Resistor  
 R1T..... Thermistor (air)  
 R2T..... Thermistor (discharge)  
 R3T..... Thermistor (suction)  
 R4T..... Thermistor (heat exchanger)  
 R5T..... Thermistor (heat exchanger middle)  
 R6T..... Thermistor (liquid)  
 R7T..... Thermistor (fin)  
 S1NPH..... Pressure sensor  
 S1PH..... High pressure switch  
 V1R,V2R..... Power module  
 V3R..... Diode module  
 X1M..... Terminal strip  
 X6A,X77A..... Optional connectors  
 Y1E..... Electronic expansion valve  
 Y1S..... Solenoid valve (4-way valve)  
 Y3S..... Solenoid valve  
 Z1C~Z9C..... Noise filter (ferrite core)  
 Z1F~Z4F..... Noise filter

**Door 2 electrical parts of the hydraulic compartment**

A11P.....Main PCB  
 A12P.....User interface PCB  
 A4P.....Remote alarm PCB (EKRP1HB)  
 E6H.....Expansion vessel heater  
 E7H.....Water piping heater  
 E8H.....Heatertape (field supply max. 200 W)  
 FU1.....Fuse 3.15 A T 250 V for PCB  
 FU2.....Fuse 5 A T 250 V  
 FuR,FuS.....Fuse 5 A 250 V for remote alarm PCB  
 K4M.....Pump relay  
 K9M.....Heaters relay  
 M1P.....Pump  
 PHC1.....Optocoupler input circuit  
 Q1DI.....Earth leakage protector  
 R11T.....Outlet water heat exchanger thermistor  
 R13T.....Refrigerant liquid side thermistor  
 R14T.....Inlet water thermistor  
 S1L.....Flow switch  
 S12M.....Main switch  
 S2S.....Benefit kWh rate power signal  
 S3S.....Remote heating signal  
 S4S.....Remote cooling signal  
 S5S.....Remote ON/OFF signal  
 SS1,SS2.....DIP switch  
 TR1.....Transformer 24 V for PCB  
 V1S,V2S.....Spark suppression 1, 2  
 X2M.....Terminal strips  
 X1Y,X2Y.....Connector



When finishing cables inside the unit, make sure the cables do not touch the pump or refrigerant piping.

**Field wiring guidelines**



Do not operate the unit by shortcircuiting protection devices S1L and S12M.

- Most field wiring on the unit is to be made on the terminal block or the main switch inside the switch box. To gain access to the terminal block or main switch, remove the switch box service panel (door 2).
- Cable tie mountings are provided at the bottom of the switch box. Fix all cables using cable ties.

*Secure the wiring in the order shown below.*

- Lay the electrical wiring so that the front cover does not rise up when doing wiring work and attach the front cover securely(see figure 2).
- Follow the electric wiring diagram for electrical wiring works (the electric wiring diagrams are located on the rear side of doors 1 and 2).
- Form the wires and fix the cover firmly so that the cover may be fit in properly.

## Precautions on wiring of power supply

- For connection of the field wiring to the mains switch, use the instruction as described below.

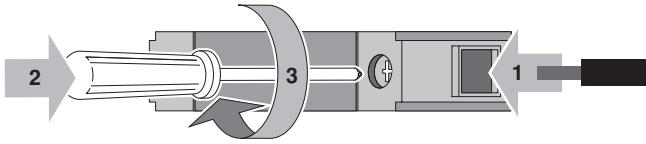

- For other connections, use a round crimp-style terminal for connection to the power supply terminal board. In case it cannot be used due to unavoidable reasons, be sure to observe the following instruction (e.g. connection of the earth wire).

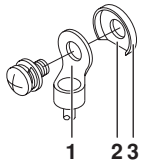

- Round pressure terminal
- Cut out section
- Cup washer

- Do not connect wires of different gauge to the same power supply terminal. (Looseness in the connection may cause overheating.)
- When connecting wires of the same gauge, connect them according to the below figure.



- Use the correct screwdriver to tighten the terminal screws. Small screwdrivers can damage the screw head and prevent appropriate tightening.
- Over-tightening the terminal screws can damage the screws.
- See the table below for tightening torques for the terminal screws.

Tightening torque (N·m)	
M4 (X1M)	1.2~1.8
M5 (X1M)	2.0~3.0
M5 (EARTH)	3.0~4.0

- Attach an earth leakage circuit breaker and fuse to the power supply line.
- In wiring, make certain that prescribed wires are used, carry out complete connections, and fix the wires so that outside forces are not applied to the terminals.



The earth leakage circuit breaker must be a high-speed type breaker of 30 mA (<0.1 s).

For V3 model: Equipment complying with EN/IEC 61000-3-12 (European/International Technical Standard setting the limits for harmonic currents produced by equipment connected to public low-voltage systems with input current >16 A and ≤75 A per phase.)

The wiring diagram can be found on the inside of the front plate of the unit.

## Connection of the thermostat cable

Connection of the thermostat cable depends on the application.

See also "Typical application examples" on page 6.

### Thermostat requirements

- Contact voltage: 230 V.

### Procedure

- Connect the thermostat cable to the appropriate terminals as shown on the wiring diagram.

#### Heating/cooling thermostat

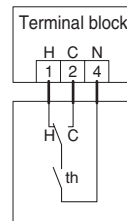

#### Remote ON/OFF

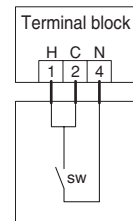

- Fix the cable with cable ties to the cable tie mountings to ensure strain relief.



- When a room thermostat is connected to the unit, the heating and cooling schedule timers are never available. Other schedule timers are not affected. For more information on the schedule timers, refer to the operation manual.

- When a room thermostat is connected to the unit, and the button or button is pressed, the centralised control indicator will flash to indicate that the room thermostat has priority and controls on/off operation and change over operation.

## Specifications of standard wiring components

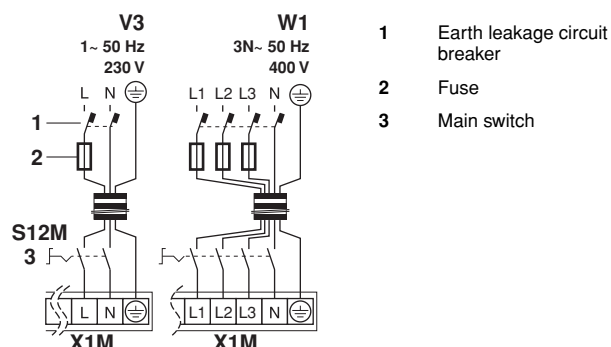

	V3	W1
Minimum circuit amps (MCA) <sup>(a)</sup>	28.2	13.5
Recommended field fuse	32 A	20 A
Wire type <sup>(b)</sup>	H05VV-U3G	H05VV-U5G
Size	Wiring size must comply with the applicable local and national code	
Wire type of wiring between the units	H05VV-U4G2.5	

(a) Stated values are maximum values.

(b) Only in protected pipes, use H07RN-F when protected pipes are not used.



The following table summarizes the required configuration and thermostat wiring at the terminal block in the switch box. Pump operation is listed in the third column. The three last columns indicate whether the following functionality is available on the user interface (UI) or handled by the thermostat (T):

- space heating or cooling on/off (ON/OFF)
- heating/cooling changeover (H/C)
- heating and cooling schedule timers (T)

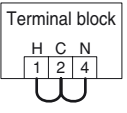
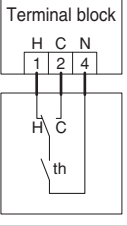
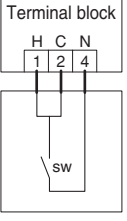
Thermostat	Configuration	Pump operation	ON/OFF	H/C	T
No thermostat	wiring: 	on when unit is on	UI	UI	UI
Thermostat with heating/cooling switch	wiring: 	on when heating request or cooling request by room thermostat	T	T	—
Remote ON/OFF switch	wiring: 	on when remote on	T	—	—

th = Thermostat contact  
 C = Cooling contact  
 H = Heating contact  
 N = Neutral  
 sw = Switch

## Connection to a benefit kWh rate power supply

Electricity companies throughout the world work hard to provide reliable electric service at competitive prices and are often authorized to bill clients at benefit rates. E.g. time-of-use rates, seasonal rates, Wärmepumpentarif in Germany and Austria, ... . This equipment allows for connection to such benefit rate power supply delivery systems.

Consult with the electricity company acting as provider at the site where this equipment is to be installed to know whether it is appropriate to connect the equipment in one of the benefit kWh rate power supply delivery systems available, if any.

When the equipment is connected to such benefit kWh rate power supply, the electricity company is allowed to:

- interrupt power supply to the equipment for certain periods of time;
- demand that the equipment only consumes a limited amount of electricity during certain periods of time.

The unit is designed to receive an input signal by which the unit switches into forced off mode. At that moment, the unit compressor will not operate.



### Warnings

#### for a benefit kWh rate power supply like illustrated below as type 1

- If the benefit kWh rate power supply is of the type that power supply is not interrupted, then control of the heaters is still possible.  
 For the different possibilities of controlling heaters at moments that benefit kWh rate is active, refer to "[D] Benefit kWh rate power supply" on page 20.  
 If heaters must be controlled at moments that the benefit kWh rate power supply is off, then these heaters have to be connected to a separate power supply.
- During the period that the benefit kWh rate is active and power supply is continuous, then stand-by power consumption is possible (PCB, controller, pump, ...).

#### for a benefit kWh rate power supply like illustrated below as types 2 or 3

Benefit kWh rate power supplies that completely shut power supply are not allowed for OP10 models because of the heater tape that would not be powered.

## Possible types of benefit kWh rate power supply

Possible connections and requirements to connect the equipment to such power supply are illustrated in the figure below:

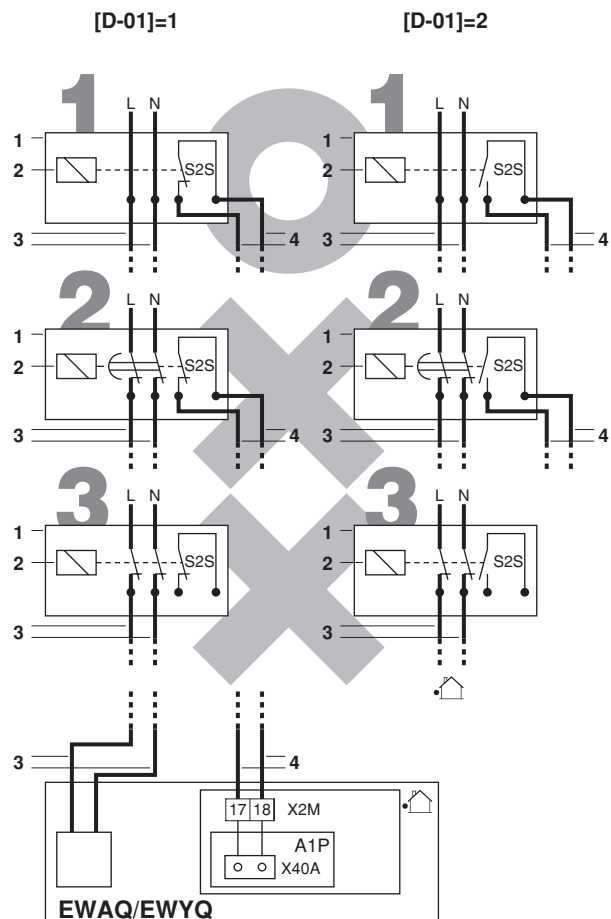

- 1 Benefit kWh rate power supply box
- 2 Receiver controlling the signal of the electricity company
- 3 Power supply to unit
- 4 Voltage free contact
- Allowed for all models
- ✗ Not allowed for OP10 models, allowed for other models

When the unit is connected to a benefit kWh rate power supply, the voltage free contact of the receiver controlling the benefit kWh rate signal of the electricity company must be connected to clamps 17 and 18 of X2M (as illustrated in the figure above).

When parameter [D-01]=1 at the moment that the benefit kWh rate signal is sent by the electricity company, that contact will open and the unit will go in forced off mode<sup>(1)</sup>.

When parameter [D-01]=2 at the moment that the benefit kWh rate signal is sent by the electricity company, that contact will close and the unit will go in forced off mode<sup>(2)</sup>.

### type 1

The benefit kWh rate power supply is of the type that power supply is not interrupted.

### type 2 and 3

The benefit kWh rate power supply is of the type that power supply will be interrupted after elapse of time or is interrupted immediately.



- Benefit kWh rate power supplies that completely shut power supply like illustrated above as types 2 and 3 are not allowed for this application because of the water freeze prevention that would not be powered.
- When connecting the equipment to a benefit kWh rate power supply, change field settings [D-01] and both [D-01] and [D-00] in case the benefit kWh rate power supply is of the type that power supply is not interrupted (like illustrated above as type 1). Refer to "[D] Benefit kWh rate power supply" on page 20 of chapter "Field settings".

#### NOTE



If the benefit kWh rate power supply is of the type that power supply is not interrupted, the unit will be forced to off.

## Installation of the digital controller

The unit is equipped with a digital controller offering a user-friendly way to set up, use and maintain the unit. Before operating the controller, follow this installation procedure.

### Wiring specifications

Wire specification	Value
Type	2 wire
Section	0.75-1.25 mm <sup>2</sup>
Maximum length	500 m

#### NOTE



The wiring for connection is not included.

### Mounting



The digital controller, delivered in a kit, has to be mounted indoors.

- 1 Remove the front part of the digital controller.  
Insert a slotted screwdriver into the slots (1) in the rear part of the digital controller, and remove the front part of the digital controller.
- 2 Fasten the digital controller on a flat surface.

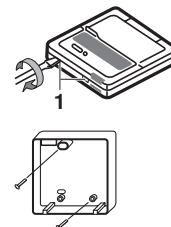

#### NOTE



Be careful not to distort the shape of the lower part of the digital controller by over tightening the mounting screws.

(1) When the signal is released again, the voltage free contact will close and the unit will restart operation. It is therefore important to leave the auto restart function enabled. Refer to "[3] Auto restart" on page 19.

(2) When the signal is released again, the voltage free contact will open and the unit will restart operation. It is therefore important to leave the auto restart function enabled. Refer to "[3] Auto restart" on page 19.

### 3 Wire the unit.

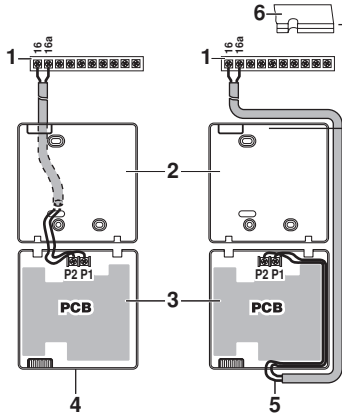

- 1 Unit
- 2 Rear part of the digital controller
- 3 Front part of the digital controller
- 4 Wired from the rear
- 5 Wired from the top
- 6 Notch the part for the wiring to pass through with nippers, etc.

Connect the terminals on top of the front part of the digital controller and the terminals inside the unit (P1 to 16, P2 to 16a).

#### NOTE



- When wiring, run the wiring away from the power supply wiring in order to avoid receiving electric noise (external noise).
- Peel the shield for the part that has to pass through the inside of the digital controller case ( / ).

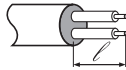

### 4 Reattach the upper part of the digital controller.



Be careful not to pinch the wiring when attaching.

First begin fitting from the clips at the bottom.

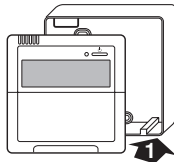

## START-UP AND CONFIGURATION

The unit should be configured by the installer to match the installation environment (outdoor climate, installed options, etc.) and user expertise.



It is important that **all** information in this chapter is read sequentially by the installer and that the system is configured as applicable.

### Pump operation configuration

#### NOTE



To set the pump speed, refer to "Setting the pump speed" on page 17.

### Initial start-up at low outdoor ambient temperatures

During initial start-up and when water temperature is low, it is important that the water is heated gradually. Failure to do so may result in cracking of concrete floors due to rapid temperature change. Please contact the responsible cast concrete building contractor for further details.

To do so, the lowest leaving water set temperature can be decreased to a value between 25°C and 37°C by adjusting the field setting [9-01] (heating set point lower limit). Refer to "Field settings" on page 18.

### Pre-operation checks

#### Checks before initial start-up



Switch off the power supply before making any connections.

After the installation of the unit, check the following before switching on the circuit breaker:

- 1 Field wiring
 

Make sure that the field wiring has been carried out according to the instructions and guidelines as described in the chapter "Field wiring" on page 11, according to the wiring diagrams and according to European and national regulations.
- 2 Fuses or protection devices
 

Check that the fuses or the locally installed protection devices are of the size and type specified in the chapter "Technical specifications" on page 25. Make sure that neither a fuse nor a protection device has been bypassed.
- 3 Earth wiring
 

Make sure that the earth wires have been connected properly and that the earth terminals are tightened.
- 4 Internal wiring
 

Visually check the switch box on loose connections or damaged electrical components.
- 5 Fixation
 

Check that the unit is properly fixed, to avoid abnormal noises and vibrations when starting up the unit.
- 6 Damaged equipment
 

Check the inside of the unit on damaged components or squeezed pipes.
- 7 Refrigerant leak
 

Check the inside of the unit on refrigerant leakage. If there is a refrigerant leak, call your local dealer.

## 8 Power supply voltage

Check the power supply voltage on the local supply panel. The voltage must correspond to the voltage on the identification label of the unit.

## 9 Air purge valve

Make sure the air purge valve is open (at least 2 turns).

## 10 Pressure relief valve

Check if the unit is completely filled with water by operating the pressure relief valve. It should purge water instead of air.

## 11 Shut-off valves

Make sure that the shut-off valves are fully open.



Operating the system with closed valves will damage the pump!

## 12 Protection against freezing

Make sure that in colder climates (ambient temperature can become lower than 0°C) the unit is protected against freezing by means of a heater tape or by adding glycol to the water.

Also refer to "Protecting the water circuit against freezing" on page 10.

## 13 Mainswitch handle

Mount the mainswitch handle and fasten screw in order to power up the unit.

## 14 Protection cap(s)

Protection cap(s) must be mounted on the right side of the mainswitch after connection of the field wiring.

## Powering up the unit

### 1 Switch on the main switch on the unit.

### 2 When power supply to the unit is turned on, "88" is displayed on the user interface during its initialisation, which might take up to 30 seconds. During this process the user interface cannot be operated.

## Failure diagnosis at the moment of first installation

- In case nothing is displayed on the remote controller (the current set temperature does not display), check for any of the following abnormalities before you can diagnose possible malfunction codes.
  - Disconnection or wiring error (between power supply and unit, between unit and remote controller).
  - The fuse on the outdoor unit PCB may have run out.
- If the remote controller shows "E3", "E4" or "LB" as an error code, there is a possibility that either the stop valves are closed, or that air inlet or air outlet are blocked.
- If the error code "L2" is displayed on the remote controller, check for voltage imbalance.
- If the error code "L4" is displayed on the remote controller, it is possible that air inlet or air outlet are blocked.
- The reversed phase protection detector of this product only works during the initialisation stage after a power reset. The reversed phase protection detector is designed to stop the product in case of an abnormality when the product is started up.
  - When the reversed phase protection circuit forced the unit to stop, check if all phases are existing. If this is the case, shut off the power supply to the unit and replace two of three phases. Turn on power again and start the unit.
  - Reversed phase detection is not performed while the product is operating.

- In case of possible reversal of phases after a momentary black out of power and the power goes on and off while the product is operating, install a reversed phase protection circuit on site. Such situation is not unimaginable when using generators. Running the product in reversed phase can break the compressor and other parts.

- For a missing phase in case of W1 units, "E7" or "L2" will be displayed on the remote controller of the indoor unit. Operation will be impossible with either one of these phenomena. If this happens, turn off the power, re-check the wiring and switch the position of two of the three electrical wires. (If operation is not possible, do not under any circumstances force the electromagnetic contactor on.)

## Setting the pump speed

The pump speed can be selected on the pump (see "Main components" on page 7).

The default setting is high speed (I). If the water flow in the system is too high (e.g., noise of running water in the installation) the speed can be set to low speed (II).



**NOTE** The speed dial on the pump indicates 3 speed settings. However, only 2 speed settings exist: low speed and high speed. The indicated medium speed setting on the speed dial is equal to low speed.

The available external static pressure (ESP, expressed in kPa) in function of the water flow (l/min) is shown in the graph below.

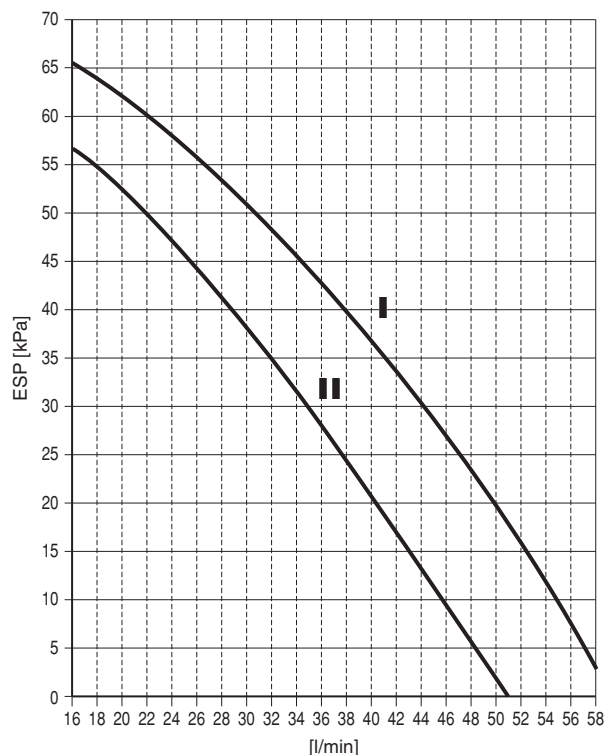

## Field settings

The unit should be configured by the installer to match the installation environment (outdoor climate, installed options, etc.) and user demand. There to, a number of so called field settings are available. These field settings are accessible and programmable through the user interface.

Each field setting is assigned a 3-digit number or code, for example [5-03], which is indicated on the user interface display. The first digit [5] indicates the 'first code' or field setting group. The second and third digit [03] together indicate the 'second code'.

A list of all field settings and default values is given under "[Field settings table](#)" on page 21. In this same list, we provided for 2 columns to register the date and value of altered field settings at variance with the default value.

A detailed description of each field setting is given under "[Detailed description](#)" on page 18.

## Procedure

To change one or more field settings, proceed as follows.

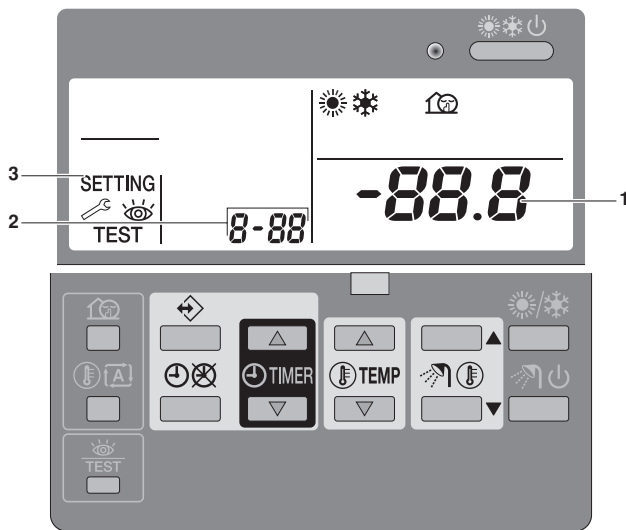

- 1 Press the button for a minimum of 5 seconds to enter FIELD SET MODE.  
The **SETTING** icon (3) will be displayed. The current selected field setting code is indicated **8-88** (2), with the set value displayed to the right **-88.8** (1).
- 2 Press the button to select the appropriate field setting first code.
- 3 Press the button to select the appropriate field setting second code.
- 4 Press the button and button to change the set value of the select field setting.
- 5 Save the new value by pressing the .
- 6 Repeat step 2 through 4 to change other field settings as required.
- 7 When finished, press the button to exit FIELD SET MODE.

### NOTE



Changes made to a specific field setting are only stored when the button is pressed. Navigating to a new field setting code or pressing the button will discard the change made.

### NOTE



- Before shipping, the set values have been set as shown under "[Field settings table](#)" on page 21.
- When exiting FIELD SET MODE, "88" may be displayed on the user interface LCD while the unit initialises itself.

## Detailed description

### [0] User permission level

If required, certain user interface buttons can be made unavailable for the user.

Three permission levels are defined (see the table below). Switching between level 1 and level 2/3 is done by simultaneously pressing buttons and immediately followed by simultaneously pressing buttons and , and keeping all 4 buttons pressed for at least 5 seconds (in normal mode). Note that no indication on the user interface is given. When level 2/3 is selected, the actual permission level — either level 2 or level 3 — is determined by the field setting [0-00].

Button	Icon	Permission level		
		1	2	3
On/off button		operable	operable	operable
Operation changeover button		operable	operable	operable
Sanitary water heating button		– Not available –		
Sanitary temperature adjust buttons		– Not available –		
Temperature adjust buttons	 	operable	operable	operable
Time adjust buttons	 	operable		
Programming button		operable		
Schedule timer enable/disable button		operable	operable	
Quiet mode button		operable		
Weather dependent set point button		operable		
Inspection/test operation button		operable		

### [1] Weather dependent set point (heat pump models only)

The weather dependent set point field settings define the parameters for the weather dependent operation of the unit. When weather dependent operation is active the water temperature is determined automatically depending on the outdoor temperature: colder outdoor temperatures will result in warmer water and vice versa. During weather dependent operation, the user has the possibility to shift up or down the target water temperature by a maximum of 5°C. See the operation manual for more details on weather dependent operation.

- [1-00] Low ambient temperature (Lo\_A): low outdoor temperature.
- [1-01] High ambient temperature (Hi\_A): high outdoor temperature.
- [1-02] Set point at low ambient temperature (Lo\_Ti): the target outgoing water temperature when the outdoor temperature equals or drops below the low ambient temperature (Lo\_A).  
Note that the Lo\_Ti value should be *higher* than Hi\_Ti, as for colder outdoor temperatures (i.e. Lo\_A) warmer water is required.
- [1-03] Set point at high ambient temperature (Hi\_Ti): the target outgoing water temperature when the outdoor temperature equals or rises above the high ambient temperature (Hi\_A).  
Note that the Hi\_Ti value should be *lower* than Lo\_Ti, as for warmer outdoor temperatures (i.e. Hi\_A) less warm water suffices.

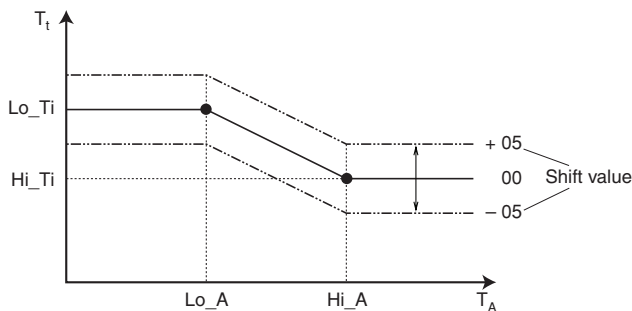

$T_t$  Target water temperature  
 $T_A$  Ambient (outdoor) temperature

Shift value = Shift value

### [3] Auto restart

When power returns after a power supply failure, the auto restart function reapplies the user interface settings at the time of the power supply failure.

**NOTE** It is therefore recommended to leave the auto restart function enabled.

Note that with the function disabled the schedule timer will not be activated when power returns to the unit after a power supply failure. Press the button to enable the schedule timer again.

- [3-00] Status: defines whether the auto restart function is turned **ON (0)** or **OFF (1)**.

**NOTE** If the benefit kWh rate power supply is of the type that power supply is interrupted, then always allow the auto restart function.

### [9] Cooling and heating set points

The purpose of this field setting is to prevent the user from selecting a wrong (i.e., too hot or too cold) leaving water temperature. Thereby the heating temperature set point range and the cooling temperature set point range available to the user can be configured.



In case of a floor cooling application, it is important to limit the minimum leaving water temperature at cooling operation (field setting of parameter [9-03]) to 16~18°C to prevent condensation on the floor.

- [9-00] Heating set point upper limit: maximum leaving water temperature for heating operation.
- [9-01] Heating set point lower limit: minimum leaving water temperature for heating operation.
- [9-02] Cooling set point upper limit: maximum leaving water temperature for cooling operation.
- [9-03] Cooling set point lower limit: minimum leaving water temperature for cooling operation.
- [9-04] Overshoot setting: defines how much the water temperature may rise above the setpoint before the compressor stops. This function is only applicable in heating mode.

### [A] Quiet mode

This field setting allows to select the desired quiet mode. Two quiet modes are available: quiet mode A and quiet mode B.

In quiet mode A, priority is given to the unit operating quietly under **all** circumstances. Fan and compressor speed (and thus performance) will be limited to a certain percentage of the speed at normal operation. In certain cases, this might result in reduced performance.

In quiet mode B, quiet operation might be overridden when higher performance is required. In certain cases, this might result in less quiet operation of the unit to meet the requested performance.

- [A-00] Quiet mode type: defines whether quiet mode A (0) or quiet mode B (2) is selected.
- [A-01] Parameter 01: do not change this setting. Leave it set to its default value.



Do not set other values than the ones mentioned.

### [C] Alarm output logic of EKR1HB

- [C-01] Defines the logic of the alarm output on the EKR1HB remote alarm input/output PCB.

If [C-01]=0, the alarm output will be powered when an alarm occurs (default).

If [C-01]=1, the alarm output will not be powered when an alarm occurs. This field setting allows for distinction between detection of an alarm and detection of a power failure to the unit.

[C-01]	Alarm	No alarm	No power supply to unit
0 (default)	Closed output	Open output	Open output
1	Open output	Closed output	Open output

## [D] Benefit kWh rate power supply

- If [D-01]=1 or 2 and the benefit kWh rate signal of the electricity company is received, following devices will be switched off:

[D-00]	Compressor
0 (default)	Forced off
1	Forced off
2	Forced off
3	Forced off

**NOTE**  [D-00] settings 1, 2 and 3 are only meaningful if the benefit kWh rate power supply is of the type that power supply is not interrupted,

- [D-01] Defines whether or not the unit is connected to a benefit kWh rate power supply.

If [D-01]=0, the unit is connected to a normal power supply (default value).

If [D-01]=1 or 2, the unit is connected to a benefit kWh rate power supply. In this case the wiring requires specific installation like explained in "[Connection to a benefit kWh rate power supply](#)" on page 14.

When parameter [D-01]=1 at the moment that the benefit kWh rate signal is sent by the electricity company, that contact will open and the unit will go in forced off mode<sup>(1)</sup>.

When parameter [D-01]=2 at the moment that the benefit kWh rate signal is sent by the electricity company, that contact will close and the unit will go in forced off mode<sup>(2)</sup>.

## [E] Unit information readout

- [E-00] Readout of the software version (example: 23)
- [E-01] Readout of the EEPROM version (example: 23)
- [E-02] Readout of the unit model identification (example: 11)
- [E-03] Readout of the liquid refrigerant temperature
- [E-04] Readout of the inlet water temperature

**NOTE**  [E-03] and [E-04] readouts are not permanently refreshed. Temperature readouts are updated after looping through the field setting first codes again only.

(1) When the signal is released again, the voltage free contact will close and the unit will restart operation. It is therefore important to leave the auto restart function enabled. Refer to "[\[3\] Auto restart](#)" on page 19.

(2) When the signal is released again, the voltage free contact will open and the unit will restart operation. It is therefore important to leave the auto restart function enabled. Refer to "[\[3\] Auto restart](#)" on page 19.

## Field settings table

First code	Second code	Setting name	Installer setting at variance with default value				Default value	Range	Step	Unit
			Date	Value	Date	Value				
0		<b>User permission level</b>								
	00	User permission level					3	2/3	1	—
1		<b>Weather dependent set point</b>								
	00	Low ambient temperature (Lo_A)					-10	-20~5	1	°C
	01	High ambient temperature (Hi_A)					15	10~20	1	°C
	02	Set point at low ambient temperature (Lo_TI)					40	25~55	1	°C
	03	Set point at high ambient temperature (Hi_TI)					25	25~55	1	°C
2		<b>Not available</b>								
3		<b>Auto restart</b>								
	00	Status					0 (ON)	0/1	—	—
4		<b>Not available</b>								
5		<b>Not available</b>								
6		<b>Not available</b>								
7		<b>Not available</b>								
8		<b>Not available</b>								
9		<b>Cooling and heating set point ranges</b>								
	00	Heating set point upper limit					55	37~55	1	°C
	01	Heating set point lower limit					15	15~37	1	°C
	02	Cooling set point upper limit					22	18~22	1	°C
	03	Cooling set point lower limit					5	5~18	1	°C
	04	Overshoot setting					2	1~4	1	°C
A		<b>Quiet mode</b>								
	00	Quiet mode type					0	0/2	—	—
	01	Parameter 01					3	—	—	—
C		<b>Alarm output logic of EKR1HB</b>								
	00	Not applicable. Do not change the default value!					0	—	—	—
	01	Output logic of the EKR1HB remote alarm input/output PCB					0	0/1	—	—
D		<b>Benefit kWh rate power supply</b>								
	00	Not available								
	01	Unit connection to benefit kWh rate power supply					0 (OFF)	0/1/2	—	—
	02	Not applicable. Do not change the default value!					0	—	—	—
E		<b>Unit information readout</b>								
	00	Software version					Read only	—	—	—
	01	EEPROM version					Read only	—	—	—
	02	Unit model identification					Read only	—	—	—
	03	Liquid refrigerant temperature					Read only	—	—	°C
	04	Inlet water temperature					Read only	—	—	°C











## TEST RUN AND FINAL CHECK

The installer is obliged to verify correct operation of unit after installation.

### Test run operation (manual)



If required, the installer can perform a manual test run operation at any time to check correct operation of cooling and heating.

#### Procedure

- 1 Push the  button 4 times so the **TEST** icon will be displayed.
- 2 Depending on the unit model, heating operation, cooling operation or both must be tested as follows (when no action is performed, the user interface will return to normal mode after 10 seconds or by pressing the  button once):
  - To test the heating operation push the  button so the  icon is displayed. To start the test run operation press the  button.
  - To test the cooling operation push the  button so the  icon is displayed. To start the test run operation press the  button.
- 3 The test run operation will end automatically after 30 minutes or when reaching the set temperature. The test run operation can be stopped manually by pressing the  button once. If there are misconnections or malfunctions, an error code will be displayed on the user interface. Otherwise, the user interface will return to normal operation.
- 4 To resolve the error codes, see "[Error codes](#)" on page 24.

#### NOTE



To display the last resolved error code, push the  button 1 time. Push the  button again 4 times to return to normal mode.

#### NOTE



It is not possible to perform a test run if a forced operation from the unit is in progress. Should forced operation be started during a test run, the test run will be aborted.

### Final check

Before switching on the unit, read following recommendations:

- When the complete installation and all necessary settings have been carried out, close all front panels of the unit and refit the unit cover.
- The service panel of the switch box may only be opened by a licensed electrician for maintenance purposes.

#### NOTE



Note that during the first running period of the unit, required power input may be higher than stated on the nameplate of the unit. This phenomenon originates from the compressor that needs elapse of a 50 hours run in period before reaching smooth operation and stable power consumption.

## MAINTENANCE

In order to ensure optimal availability of the unit, a number of checks and inspections on the unit and the field wiring have to be carried out at regular intervals.



- Before carrying out any maintenance or repair activity, always switch off the circuit breaker on the supply panel, remove the fuses or open the protection devices of the unit.
- Make sure that before starting any maintenance or repair activity, also the power supply to the unit is switched off.

Beware that some parts of the unit can be extremely hot.

### Chiller unit

The described checks must be executed at least **once a year** by qualified personnel.

- 1 Water pressure  
Check if the water pressure is above 0.3 bar. If necessary add water.
- 2 Water filter  
Clean the water filter.
- 3 Water pressure relief valve  
Check for correct operation of the pressure relief valve by turning the red knob on the valve counter-clockwise:
  - If you do not hear a clacking sound, contact your local dealer.
  - In case the water keeps running out of the unit, close both the water inlet and outlet shut-off valves first and then contact your local dealer.
- 4 Pressure relief valve hose  
Check that the pressure relief valve hose is positioned appropriately to drain the water.
- 5 Air heat exchanger  
Remove dust and any other contaminant from the coil fins using a brush and a blower. Blow from the inside of the unit. Take care not to bend or damage the fins.
- 6 Fan motor
  - Clean the cooling ribs of the motor.
  - Check on abnormal noises. If the fan or motor are damaged, contact your local Daikin dealer.
- 7 Unit switch box  
Carry out a thorough visual inspection of the switch box and look for obvious defects such as loose connections or defective wiring.
- 8 In case of use of glycol  
Document the glycol concentration and the pH-value in the system at least once a year.
  - A pH-value below 8.0 indicates that a significant portion of the inhibitor has been depleted and that more inhibitor needs to be added.
  - When the pH-value is below 7.0 then oxidation of the glycol occurred, the system should be drained and flushed thoroughly before severe damage occurs.

Make sure that the disposal of the glycol solution is done in accordance with relevant local and national legislation.

## Digital controller

The digital controller does not need maintenance.

Remove dirt with a soft damp cloth.

## TROUBLESHOOTING

This section provides useful information for diagnosing and correcting certain troubles which may occur in the unit.

### General guidelines

Before starting the troubleshooting procedure, carry out a thorough visual inspection of the unit and look for obvious defects such as loose connections or defective wiring.

Before contacting your local dealer, read this chapter carefully, it will save you time and money.



When carrying out an inspection on the switch box of the unit, always make sure that the main switch of the unit is switched off.

When a safety device was activated, stop the unit and find out why the safety device was activated before resetting it. Under no circumstances safety devices may be bridged or changed to a value other than the factory setting. If the cause of the problem cannot be found, call your local dealer.

If the pressure relief valve is not working correctly and is to be replaced, always reconnect the flexible hose attached to the pressure relief valve, to avoid water dripping out of the unit!

#### NOTE



For problems related to the optional remote alarm kit, refer to the troubleshooting in the installation manual of that kit.

## General symptoms

### Symptom 1: The unit is turned on (LED is lit) but the unit is not heating or cooling as expected

POSSIBLE CAUSES	CORRECTIVE ACTION
The temperature setting is not correct.	Check the controller set point.
The water flow is too low.	<ul style="list-style-type: none"><li>• Check that all shut off valves of the water circuit are completely open.</li><li>• Check if the water filter needs cleaning.</li><li>• Make sure there is no air in the system (purge air).</li><li>• Check on the manometer that there is sufficient water pressure. The water pressure must be &gt;0.3 bar (water is cold), &gt;&gt;0.3 bar (water is hot).</li><li>• Check that the pump speed setting is on the highest speed.</li><li>• Make sure that the expansion vessel is not broken.</li><li>• Check that the resistance in the water circuit is not too high for the pump (refer to "Setting the pump speed" on page 17).</li></ul>
The water volume in the installation is too low.	Make sure that the water volume in the installation is above the minimum required value (refer to "Checking the water volume and expansion vessel pre-pressure" on page 9).

### Symptom 2: The unit is turned on but the compressor is not starting (heating)

POSSIBLE CAUSES	CORRECTIVE ACTION
The benefit kWh rate power supply settings and electrical connections do not match.	If [D-01]=1 or 2, the wiring requires specific installation like illustrated in "Connection to a benefit kWh rate power supply" on page 14. Other correctly installed configurations are possible, but are to be specific for the type of benefit kWh rate power supply type at this specific site.
The benefit kWh rate signal was sent by the electricity company.	Wait for the power to return.

### Symptom 3: Pump is making noise (cavitation)

POSSIBLE CAUSES	CORRECTIVE ACTION
There is air in the system.	Purge air.
Water pressure at pump inlet is too low.	<ul style="list-style-type: none"><li>• Check on the manometer that there is sufficient water pressure. The water pressure must be &gt;0.3 bar (water is cold), &gt;&gt;0.3 bar (water is hot).</li><li>• Check that the manometer is not broken.</li><li>• Check that the expansion vessel is not broken.</li><li>• Check that the setting of the pre-pressure of the expansion vessel is correct (refer to "Setting the pre-pressure of the expansion vessel" on page 9).</li></ul>

### Symptom 4: The water pressure relief valve opens

POSSIBLE CAUSES	CORRECTIVE ACTION
The expansion vessel is broken.	Replace the expansion vessel.
The water volume in the installation is too high.	Make sure that the water volume in the installation is under the maximum allowed value (refer to "Checking the water volume and expansion vessel pre-pressure" on page 9).

### Symptom 5: The water pressure relief valve leaks

POSSIBLE CAUSES	CORRECTIVE ACTION
Dirt is blocking the water pressure relief valve outlet.	Check for correct operation of the pressure relief valve by turning the red knob on the valve counter clockwise: <ul style="list-style-type: none"> <li>If you do not hear a clacking sound, contact your local dealer.</li> <li>In case the water keeps running out of the unit, close both the water inlet and outlet shut-off valves first and then contact your local dealer.</li> </ul>

### Symptom 6: The user interface displays "NOT AVAILABLE" when pressing certain buttons



POSSIBLE CAUSES	CORRECTIVE ACTION
The current permission level is set to a level that prevents using the pressed button.	Change the "user permission level" field setting ([0-00], see "Field settings" on page 18.

### Error codes

When a safety device is activated, the user interface LED will be flashing, and an error code will be displayed.

A list of all errors and corrective actions can be found in the table below.

Reset the safety by turning the unit OFF and back ON.

Instruction to turn the unit OFF	
User interface mode (heating/cooling  )	Push the  button
ON	1 time
ON	1 time
OFF	—
OFF	—

In case this procedure for resetting the safety is not successful, contact your local dealer.

Error code	Failure cause	Corrective action
80	Inlet water temperature thermistor failure (inlet water thermistor broken)	Contact your local dealer.
8i	Outlet water temperature thermistor failure (outlet water temperature sensor broken)	Contact your local dealer.
89	Water heat exchanger freeze-up failure (due to water flow too low)	Refer to error code 7H.
	Water heat exchanger freeze-up failure (due to refrigerant shortage)	Contact your local dealer.
7H	Flow failure (water flow too low or no water flow at all, minimum required water flow is 16 l/min)	<ul style="list-style-type: none"> <li>Check that all shut off valves of the water circuit are completely open.</li> <li>Check if the water filter needs cleaning.</li> <li>Check that the unit is operating within its operating range (refer to "Technical specifications" on page 25).</li> <li>Also refer to "Charging water" on page 10.</li> <li>Make sure there is no air in the system (purge air).</li> <li>Check on the manometer that there is sufficient water pressure. The water pressure must be &gt;0.3 bar (water is cold), &gt;&gt;0.3 bar (water is hot).</li> <li>Check that the pump speed setting is on the highest speed.</li> <li>Make sure that the expansion vessel is not broken.</li> <li>Check that the resistance in the water circuit is not too high for the pump (refer to "Setting the pump speed" on page 17).</li> <li>Check that the pump fuse (FU2) and PCB fuse (FU1) are not blown.</li> </ul>

Error code	Failure cause	Corrective action
8H	Outlet water temperature of unit too high (>65°C)	Check that the outlet water thermistor is giving the correct read out.
R1	Hydraulic PCB defective	Contact your local dealer.
R5	Too low (during cooling operation) or too high (during heating operation) refrigerant temperature (measured by R13T)	Contact your local dealer.
C0	Flow switch failure (flow switch remains closed while pump is stopped)	Check that the flow switch is not clogged with dirt.
C4	Heat exchanger thermistor failure (heat exchanger temperature sensor broken)	Contact your local dealer.
E1	Compressor PCB defective	Contact your local dealer.
E3	Abnormal high pressure	Check that the unit is operating within its operating range (refer to "Technical specifications" on page 25). Contact your local dealer.
E4	Actuation of low pressure sensor	Check that the unit is operating within its operating range (refer to "Technical specifications" on page 25). Contact your local dealer.
E5	Overload activation of compressor	Check that the unit is operating within its operating range (refer to "Technical specifications" on page 25). Contact your local dealer.
E7	Fan lock failure (fan is locked)	Check if the fan is not obstructed by dirt. If the fan is not obstructed, contact your local dealer.
E9	Malfunction of electronic expansion valve	Contact your local dealer.
F3	Too high discharge temperature (e.g. due to coil blockage)	Clean the coil. If the coil is clean, contact your local dealer.
H3	Malfunctioning HPS system	Contact your local dealer.
H9	Outdoor temperature thermistor failure (outdoor thermistor is broken)	Contact your local dealer.
J1	Malfunction of pressure sensor	Contact your local dealer.
J3	Discharge pipe thermistor failure	Contact your local dealer.
J5	Suction pipe unit thermistor failure	Contact your local dealer.
J6	Aircoil thermistor frost detection failure	Contact your local dealer.
J7	Aircoil thermistor mean temperature failure	Contact your local dealer.
J8	Liquid pipe unit thermistor failure	Contact your local dealer.
L4	Electric component failure	Contact your local dealer.
L5	Electric component failure	Contact your local dealer.
L8	Electric component failure	Contact your local dealer.
L9	Electric component failure	Contact your local dealer.
LC	Electric component failure	Contact your local dealer.
P1	PCB failure	Contact your local dealer.
P4	Electric component failure	Contact your local dealer.
PJ	Failure of capacity setting	Contact your local dealer.
U0	Refrigerant failure (due to refrigerant leak)	Contact your local dealer.
U1	Power supply cables are connected in the reverse phase instead of the normal phase.	Connect the power supply cables in normal phase. Change any two of the three power supply cables (L1, L2, L3) to correct phase.
U2	Main circuit voltage failure	Contact your local dealer.
U4	Communication failure	Contact your local dealer.
U5	Communication failure	Contact your local dealer.
U7	Communication failure	Contact your local dealer.
UR	Communication failure	Contact your local dealer.

# TECHNICAL SPECIFICATIONS

## General

	V3 models (1~)						W1 models (3N~)					
	EWAQ009	EWAQ010	EWAQ011	EWYQ009	EWYQ010	EWYQ011	EWAQ009	EWAQ011	EWAQ013	EWYQ009	EWYQ011	EWYQ013
<b>Nominal capacity</b>	Refer to the Technical Data						Refer to the Technical Data					
• cooling	Refer to the Technical Data						Refer to the Technical Data					
• heating	Refer to the Technical Data						Refer to the Technical Data					
<b>Dimensions H x W x D</b>	1418 x 1435 x 382						1418 x 1435 x 382					
<b>Weight</b>												
• machine weight	180 kg						180 kg					
• operation weight	185 kg						185 kg					
<b>Connections</b>												
• water inlet/outlet	G 5/4" FBSP <sup>(a)</sup>						G 5/4" FBSP <sup>(a)</sup>					
• water drain	hose nipple						hose nipple					
• refrigerant liquid side	Ø9.5 mm (3/8 inch)						Ø9.5 mm (3/8 inch)					
• refrigerant gas side	Ø15.9 mm (5/8 inch)						Ø15.9 mm (5/8 inch)					
<b>Expansion vessel</b>												
• volume	10 l						10 l					
• maximum working pressure (MWP)	3 bar						3 bar					
<b>Pump</b>												
• type	water cooled						water cooled					
• no. of speed	2						2					
<b>Sound pressure level<sup>(b)</sup></b>												
• heating	—	—	—	51 dBA	51 dBA	51 dBA	—	—	—	51 dBA	51 dBA	52 dBA
• cooling	51 dBA	51 dBA	51 dBA	51 dBA	51 dBA	51 dBA	51 dBA	51 dBA	52 dBA	51 dBA	51 dBA	52 dBA
<b>Internal water volume</b>	4 l						4 l					
<b>Pressure relief valve</b>	3 bar						3 bar					
<b>water circuit</b>	3 bar						3 bar					
<b>Operation range - water side</b>												
• heating	—			+25~+50°C			—			+25~+50°C		
• cooling	+5~+22°C			+5~+22°C			+5~+22°C			+5~+22°C		
<b>Operation range - air side (RH: 85%)</b>												
• heating	—			-15~+35°C			—			-15~+35°C		
• cooling	+10~+46°C			+10~+46°C			+10~+46°C			+10~+46°C		

(a) FBSP = Female British Standard Pipe

(b) At 1 m in front of the unit (free field condition)

## Electrical specifications

	V3 models (1~)	W1 models (3N~)
<b>Standard unit (power supply via unit)</b>		
• power supply	230 V 50 Hz 1P	400 V 50 Hz 3P
• nominal running current	—	5.8 A

# NOTES



For more information email [info@daikinapplied.uk](mailto:info@daikinapplied.uk) or visit [www.daikinapplied.uk](http://www.daikinapplied.uk)

For all Daikin Applied UK,  
Daikin Applied Service &  
Spares enquiries call us on:  
**0345 565 2700**



Daikin Europe N.V. participates in the Eurovent Certified Performance programme for Liquid Chilling Packages and Hydronic Heat Pumps, Fan Coil Units and Variable Refrigerant Flow systems. Check ongoing validity of certificate:  
[www.eurovent-certification.com](http://www.eurovent-certification.com)

The present publication is drawn up by way of information only and does not constitute an offer binding upon Daikin Europe N.V. Daikin Europe N.V. has compiled the content of this publication to the best of its knowledge. No express or implied warranty is given for the completeness, accuracy, reliability or fitness for particular purpose of its content and the products and services presented therein. Specifications are subject to change without prior notice. Daikin Europe N.V. explicitly rejects any liability for any direct or indirect damage, in the broadest sense, arising from or related to the use and/or interpretation of this publication. All content is copyrighted by Daikin Europe N.V.

