

DAIKIN

Installation and operation manual

Packaged air-cooled water chiller

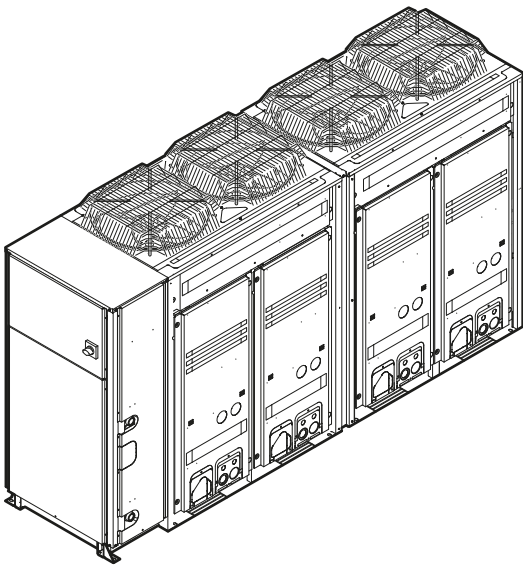

EWAQ016CAW
EWAQ021CAW
EWAQ025CAW
EWAQ032CAW
EWAQ040CAW
EWAQ050CAW
EWAQ064CAW

EWYQ016CAW
EWYQ021CAW
EWYQ025CAW
EWYQ032CAW
EWYQ040CAW
EWYQ050CAW
EWYQ064CAW

Installation and operation manual
Packaged air-cooled water chiller

English

CE-DECLARATION OF CONFORMITY
CE-CONFORMITEITSVERKLARING
CE-DECLARATION DE CONFORMITE
CE-ΔΗΛΩΣΗ ΣΥΜΜΟΡΦΩΣΗΣ
CE-DECLARACIÓN DE CONFORMIDAD
CE-DICHABARAZIONE DI CONFORMITÀ
CE-DECLARAÇÃO DE CONFORMIDADE
CE-ЗАЯВЛЕНИЕ О СООТВЕТСТВИИ
CE-УВЕРЕНИЕ В СООТВЕТСТВИИ
CE-DECLARAȚIE DE CONFORMITATE
CE-DECLARACIJA ZGODNOSTI
CE-ДЕКЛАРАЦІЯ ЗГОДНОСТІ
CE-ДЕКЛАРАЦИЈА ЗА СООТВЕТСТВИЕ
CE-IZJAVA O SKLADNOSTI
CE-VASTAVISEKILÄRITYS
CE-DECLARAȚIA DE CONFORMITATE

01 continuation of previous page;
02 Fortsetzung der vorherigen Seite;
03 suite de la page précédente;
04 vervolg van vorige pagina;
05 continuación de la página anterior;
06 Fortsetzung der vorherigen Seite;
07 anvijska od strane proizvođača;
08 continuation of the previous page;
09 Fortsetzung der vorherigen Seite;
10 Fortsetzung der vorherigen Seite;
11 Fortsetzung der vorherigen Seite;

01 Design Specifications of the models to which this declaration relates;
02 Konstruktionsdaten der Modelle auf die sich diese Erklärung bezieht;
03 Specifications of conception des modèles auxquels se rapporte cette déclaration;
04 Omvænsningsdata van de modellen waarop deze verklaring betrekking heeft;
05 Especificaciones de diseño de los modelos a los cuales hace referencia esta declaración;
06 Specificații de proiectare ale modelelor la care se referă această declarație;
07 Προδιαγραφές σχεδίασης των μοντέλων για τα οποία γίνεται η δήλωση;
08 Especificações de projeto dos modelos a que se aplica esta declaração;
09 Проектные характеристики моделей, к которым относится настоящее заявление;
10 Typespecificatien van de modellen, som denne erklaring vedrører;
11 Daspezififikationer for de modeller som denne deklaration gælder;
12 Konstruktionspezifikašioner for de modeller som berøres af denne deklarašionens;

01 - Maximum allowable pressure (PS): <P> (bar)
- Minimum maximum allowable temperature (TS);
- Minimum temperature at low pressure side <L> (°C)
- Minimum temperature corresponding with the maximum allowable pressure (PS): <P> (°C)
- Refrigerant: <R>
- Setting of pressure safety device: <S> (bar)
- Manufacturing number and manufacturing year: refer to model nameplate
02 - Maximal zulässiger Druck (PS): <P> (bar)
- Minimalmaximal zulässige Temperatur (TS);
- Minimumtemperature auf der Niederdrucksseite <L> (°C)
- Sättigungstemperatur der dem maximal zulässigen Druck (PS) entspricht: <P> (°C)
- Kältemittel: <R>
- Einstellung der Druck-Schutzvorrichtung: <S> (bar)
- Herstellerungsnummer und Herstellungsjahr: siehe Typenschild des Modells
03 - Temperatura maxima admisa (PS): <P> (bar)
- Temperatura minimuma admisa (TS);
- Temperatura minimuma cãte baze presiunii: <L> (°C)
- Temperatura saturacii corespunzătoare la presiunea maxima admisa (PS): <P> (°C)
- Refrigerant: <R>
- Regajul dispozitivului de siguranță de presiune: <S> (bar)
- Numărul de fabricație și anul de fabricație: se referă la plăcuța de identitate
04 - Maximal toelaatbare druk (PS): <P> (bar)
- Minimum maximum toelaatbare temperatuur (TS);
- Minimumtemperatuur aan lagerdrukzijde <L> (°C)
- Sättigungstemperatuur die overeenstemt met de maximum toelaatbare druk (PS): <P> (°C)
- Koelmiddel: <R>
- Instelling van drukveiligheid: <S> (bar)
- Fabricagenummer en fabricatiejaar: zie naamplaat model
05 - Presiun maxima admisa (PS): <P> (bar)
- Temperatura minimuma admisa (TS);
- Temperatura minimuma la lãtul de bazã presiunii: <L> (°C)
- Temperatura sãturãrii corespunzãtoare la presiunã maximã admisa (PS): <P> (°C)
- Refrigerant: <R>
- Ajuste de presiunã de siguranță: <S> (bar)
- Numãrul de fabricație și anul de fabricație: consulte la placa de specificație tehnice de model

01 Name and address of the Notified body that judged positively in compliance with the Pressure Equipment Directive: <D>
02 Name and address of the competent State, de posivni under Eintragung der Druckbehälter-Reguliere: <D>
03 Name and address of the organization notified, que avalia favoravelmente a conformidade da diretiva sobre equipamentos pressurizados: <D>
04 Name and address of the engineering institute de posivni geoordeed met het over de conformiteit met de richtlijn Druckapparatuur: <D>
05 Nombre y dirección de Organismo Notificado que juzgó positivamente la conformidad con la Directiva en materia de Equipos de Presión: <D>

01 Nome e indirizzo dell'Ente riconosciuto che ha riscontrato la conformità della Direttiva sulla apparecchiatura a pressione: <D>
02 Denumire și adresă a organismului notificat care a apreciat pozitiv conformitatea cu Directiva privind echipamentele sub presiune: <D>
03 Denumire și adresă a organizației notificate care a apreciat pozitiv conformitatea cu Directiva privind echipamentele sub presiune: <D>
04 Denumire și adresă a organizației notificate care a apreciat pozitiv conformitatea cu Directiva privind echipamentele sub presiune: <D>



Shigeki Morita
Director
Ostend, 1st of September 2017

CE-ERKLÄRUNG ÜBER ÜBEREINSTIMMUNG
CE-LIJUDOTIS VYBENLIKAVLAKOZAIT
CE-DECLARAȚIE DE CONFORMITATE
CE-IZJAVA O SKLADNOSTI
CE-MEGFELJESÉGI NYILATKOZAT
CE-DECLARAȚIA ZGODNOSTI
CE-DECLARAȚIE DE CONFORMITATE

12 continuation of the previous page;
13 Fortsetzung der vorherigen Seite;
14 Fortsetzung der vorherigen Seite;
15 Fortsetzung der vorherigen Seite;
16 Fortsetzung der vorherigen Seite;
17 Fortsetzung der vorherigen Seite;
18 Fortsetzung der vorherigen Seite;

13 Tãia înnoțura kosvelien malien rakemãntãmãitely;
14 Specificație designu modelu, la care se referã acestã declarație;
15 Specificație de proiectare ale modelelor la care se aplicã acestã declarație;
16 A jelen nyilatkozat tárgyát képező modellek tervezési jellemzői;
17 A jelen nyilatkozat tárgyát képező modellek tervezési jellemzői;
18 Specificațiile de proiectare ale modelelor la care se referã această declarație;
19 Specificațiile tehnice de proiectare ale modelelor la care se referã această declarație;

10 - Maks. tilađni tlak (PS): <P> (bar)
- Minimalna temperatura pri niskom pritisku: <L> (°C)
- Minimum temperature at low pressure side <L> (°C)
- Minimum temperature corresponding with the maximum allowable pressure (PS): <P> (°C)
- Hladivo: <R>
- Nastavljeno sigurnosno naprave za tlak: <S> (bar)
- Proizvodni broj i godina proizvodnje: podignite napisnu pločicu modela
11 - Maximal tillat tryck (PS): <P> (bar)
- Minimal tillat tryck (PS): <L> (°C)
- Minimumtemperatur på lågtrycksidan: <L> (°C)
- Sättningstemperatur som motsvarar maximal tillat tryck (PS): <P> (°C)
- Kälmedel: <R>
- Inställning för trycksäkerhetsapparat: <S> (bar)
- Tillverkningsnummer och tillverkningsår: se modellens märkskilt
12 - Maximum allowable pressure (PS): <P> (bar)
- Minimum maximum allowable temperature (TS);
- Minimum temperature at low pressure side <L> (°C)
- Minimum temperature corresponding with the maximum allowable pressure (PS): <P> (°C)
- Refrigerant: <R>
- Setting of pressure safety device: <S> (bar)
- Manufacturing number and manufacturing year: refer to model nameplate
02 - Maximal zulässiger Druck (PS): <P> (bar)
- Minimalmaximal zulässige Temperatur (TS);
- Minimumtemperature auf der Niederdrucksseite <L> (°C)
- Sättigungstemperatur der dem maximal zulässigen Druck (PS) entspricht: <P> (°C)
- Kältemittel: <R>
- Einstellung der Druck-Schutzvorrichtung: <S> (bar)
- Herstellerungsnummer und Herstellungsjahr: siehe Typenschild des Modells
03 - Temperatura maxima admisa (PS): <P> (bar)
- Temperatura minimuma admisa (TS);
- Temperatura minimuma cãte baze presiunii: <L> (°C)
- Temperatura saturacii corespunzătoare la presiunea maxima admisa (PS): <P> (°C)
- Refrigerant: <R>
- Regajul dispozitivului de siguranță de presiune: <S> (bar)
- Numărul de fabricație și anul de fabricație: se referă la plăcuța de identitate
04 - Maximal toelaatbare druk (PS): <P> (bar)
- Minimum maximum toelaatbare temperatuur (TS);
- Minimumtemperatuur aan lagerdrukzijde <L> (°C)
- Sättigungstemperatuur die overeenstemt met de maximum toelaatbare druk (PS): <P> (°C)
- Koelmiddel: <R>
- Instelling van drukveiligheid: <S> (bar)
- Fabricagenummer en fabricatiejaar: zie naamplaat model
05 - Presiun maxima admisa (PS): <P> (bar)
- Temperatura minimuma admisa (TS);
- Temperatura minimuma la lãtul de bazã presiunii: <L> (°C)
- Temperatura sãturãrii corespunzãtoare la presiunã maximã admisa (PS): <P> (°C)
- Refrigerant: <R>
- Ajuste de presiunã de siguranță: <S> (bar)
- Numãrul de fabricație și anul de fabricație: consulte la placa de specificație tehnice de model

14 Name and address of the Notified body that judged positively in compliance with the Pressure Equipment Directive: <D>
15 Name and address of the competent State, de posivni under Eintragung der Druckbehälter-Reguliere: <D>
16 Name and address of the organization notified, que avalia favoravelmente a conformidade da diretiva sobre equipamentos pressurizados: <D>
17 Name and address of the engineering institute de posivni geoordeed met het over de conformiteit met de richtlijn Druckapparatuur: <D>
18 Nombre y dirección de Organismo Notificado que juzgó positivamente la conformidad con la Directiva en materia de Equipos de Presión: <D>

14 Nãzev a adresa informovanãho orgãnu, ktery vrazil pozitivni posouzení stopy se smãnci o tlakovãch zařizovnãch: <D>
15 Nãzev a adresa informovanãho orgãnu, ktery vrazil pozitivni posouzení o uskãlovnãstãch s tlakovãmi zařizovnãmi: <D>
16 Nãzev a adresa informovanãho orgãnu, ktery vrazil pozitivni posouzení o uskãlovnãstãch s tlakovãmi zařizovnãmi: <D>
17 Nãzev a adresa informovanãho orgãnu, ktery vrazil pozitivni posouzení o uskãlovnãstãch s tlakovãmi zařizovnãmi: <D>
18 Denumirea și adresa organismului notificat care a apreciat pozitiv conformitatea cu Directiva privind echipamentele sub presiune: <D>

CE-DECLARAȚIE DE CONFORMITATE
CE-DECLARAȚIA ZGODNOSTI
CE-DECLARAȚIE DE CONFORMITATE
CE-IZJAVA O SKLADNOSTI
CE-VASTAVISEKILÄRITYS
CE-DECLARAȚIA DE CONFORMITATE

19 continuation of previous page;
20 Fortsetzung der vorherigen Seite;
21 Fortsetzung der vorherigen Seite;
22 Fortsetzung der vorherigen Seite;
23 Fortsetzung der vorherigen Seite;
24 Fortsetzung der vorherigen Seite;

20 Deklaratiosi ala kuuivuate mudelite disainispeafikasioinid;
21 Dooeruti sruoivuuivuuuun na kooivuate, za kooio se otnãe sruoivuuuwa;za;
22 Konstruksiois spetsifikatsiois modelu, kuroe sruoivuuu sã deklaratsia;
23 To modelu dizaina spetsifikatsias, uz kuroin atiteksã sã deklaratsia;
24 Konstruksiois spetsifikatsiois modelu, koroio sa iãka toto vãhãssãne;
25 Bu bilidiriin ligiti odõuju modelieren Tasamõ Ozõõiliteri;

21 - Maximum allowable pressure (PS): <P> (bar)
- Minimum maximum allowable temperature (TS);
- Minimum temperature at low pressure side <L> (°C)
- Minimum temperature corresponding with the maximum allowable pressure (PS): <P> (°C)
- Hladivo: <R>
- Nastavljeno sigurnosno naprave za tlak: <S> (bar)
- Proizvodni broj i godina proizvodnje: podignite napisnu pločicu modela
22 - Maximal zulässiger Druck (PS): <P> (bar)
- Minimalmaximal zulässige Temperatur (TS);
- Minimumtemperature auf der Niederdrucksseite <L> (°C)
- Sättigungstemperatur der dem maximal zulässigen Druck (PS) entspricht: <P> (°C)
- Kältemittel: <R>
- Einstellung der Druck-Schutzvorrichtung: <S> (bar)
- Herstellerungsnummer und Herstellungsjahr: siehe Typenschild des Modells
03 - Temperatura maxima admisa (PS): <P> (bar)
- Temperatura minimuma admisa (TS);
- Temperatura minimuma cãte baze presiunii: <L> (°C)
- Temperatura saturacii corespunzătoare la presiunea maxima admisa (PS): <P> (°C)
- Refrigerant: <R>
- Regajul dispozitivului de siguranță de presiune: <S> (bar)
- Numărul de fabricație și anul de fabricație: se referă la plăcuța de identitate
04 - Maximal toelaatbare druk (PS): <P> (bar)
- Minimum maximum toelaatbare temperatuur (TS);
- Minimumtemperatuur aan lagerdrukzijde <L> (°C)
- Sättigungstemperatuur die overeenstemt met de maximum toelaatbare druk (PS): <P> (°C)
- Koelmiddel: <R>
- Instelling van drukveiligheid: <S> (bar)
- Fabricagenummer en fabricatiejaar: zie naamplaat model
05 - Presiun maxima admisa (PS): <P> (bar)
- Temperatura minimuma admisa (TS);
- Temperatura minimuma la lãtul de bazã presiunii: <L> (°C)
- Temperatura sãturãrii corespunzãtoare la presiunã maximã admisa (PS): <P> (°C)
- Refrigerant: <R>
- Ajuste de presiunã de siguranță: <S> (bar)
- Numãrul de fabricație și anul de fabricație: consulte la placa de specificație tehnice de model

21 Name and address of the Notified body that judged positively in compliance with the Pressure Equipment Directive: <D>
22 Name and address of the competent State, de posivni under Eintragung der Druckbehälter-Reguliere: <D>
23 Name and address of the organization notified, que avalia favoravelmente a conformidade da diretiva sobre equipamentos pressurizados: <D>
24 Name and address of the engineering institute de posivni geoordeed met het over de conformiteit met de richtlijn Druckapparatuur: <D>
25 Nombre y dirección de Organismo Notificado que juzgó positivamente la conformidad con la Directiva en materia de Equipos de Presión: <D>

21 Nãzev a adresa informovanãho orgãnu, ktery vrazil pozitivni posouzení stopy se smãnci o tlakovãch zařizovnãch: <D>
22 Nãzev a adresa informovanãho orgãnu, ktery vrazil pozitivni posouzení o uskãlovnãstãch s tlakovãmi zařizovnãmi: <D>
23 Nãzev a adresa informovanãho orgãnu, ktery vrazil pozitivni posouzení o uskãlovnãstãch s tlakovãmi zařizovnãmi: <D>
24 Nãzev a adresa informovanãho orgãnu, ktery vrazil pozitivni posouzení o uskãlovnãstãch s tlakovãmi zařizovnãmi: <D>
25 Denumirea și adresa organismului notificat care a apreciat pozitiv conformitatea cu Directiva privind echipamentele sub presiune: <D>

| | | |
|-----|-------|--------|
| <K> | PS | 40 bar |
| <L> | Tsmin | -30 °C |
| <M> | Tsmax | 63 °C |
| <N> | | R410A |
| <P> | | 40 bar |

Table of contents

Table of contents

| | | |
|--------------------------|--|-----------|
| 1 | About the documentation | 4 |
| 1.1 | About this document..... | 4 |
| For the installer | | 5 |
| 2 | About the box | 5 |
| 2.1 | Outdoor unit..... | 5 |
| 2.1.1 | To remove the accessories from the outdoor unit..... | 5 |
| 3 | About the units and options | 5 |
| 3.1 | About the outdoor unit..... | 5 |
| 3.2 | System layout..... | 5 |
| 4 | Preparation | 5 |
| 4.1 | Preparing installation site..... | 5 |
| 4.1.1 | Installation site requirements of the outdoor unit..... | 5 |
| 4.2 | Preparing water piping..... | 6 |
| 4.2.1 | Water circuit requirements..... | 6 |
| 4.2.2 | Formula to calculate the expansion vessel pre-pressure..... | 7 |
| 4.2.3 | To check the water volume and expansion vessel pre-pressure..... | 7 |
| 4.2.4 | Changing the pre-pressure of the expansion vessel..... | 8 |
| 4.2.5 | To check the water volume: Examples..... | 8 |
| 4.3 | Preparing electrical wiring..... | 8 |
| 4.3.1 | Safety device requirements..... | 8 |
| 5 | Installation | 8 |
| 5.1 | Opening the units..... | 8 |
| 5.1.1 | To open the outdoor unit..... | 8 |
| 5.1.2 | To open the electrical component box of the outdoor unit..... | 9 |
| 5.2 | Mounting the outdoor unit..... | 9 |
| 5.2.1 | To provide the installation structure..... | 9 |
| 5.3 | Connecting the water piping..... | 10 |
| 5.3.1 | Precautions when connecting the water piping..... | 10 |
| 5.3.2 | To fill the water circuit..... | 10 |
| 5.3.3 | To protect the water circuit against freezing..... | 10 |
| 5.3.4 | To insulate the water piping..... | 11 |
| 5.4 | Connecting the electrical wiring..... | 11 |
| 5.4.1 | Field wiring: Overview..... | 11 |
| 5.4.2 | To route and fix the power supply..... | 11 |
| 5.4.3 | To install the main switch handle..... | 11 |
| 5.4.4 | To connect the power supply and transmission cables..... | 12 |
| 5.4.5 | To install the remote controller..... | 12 |
| 5.4.6 | To install optional equipment..... | 13 |
| 6 | Configuration | 13 |
| 6.1 | Overview: Configuration..... | 13 |
| 6.2 | Making field settings..... | 13 |
| 6.2.1 | About making field settings..... | 13 |
| 6.2.2 | Field setting components..... | 14 |
| 6.2.3 | To access the field setting components..... | 14 |
| 6.2.4 | To access mode 1 or 2..... | 14 |
| 6.2.5 | To use mode 1..... | 14 |
| 6.2.6 | To use mode 2..... | 15 |
| 6.2.7 | Mode 1: Monitoring settings..... | 15 |
| 6.2.8 | Mode 2: Field settings..... | 15 |
| 6.2.9 | Field settings on the remote controller..... | 16 |
| 6.3 | Switching between cooling and heating..... | 20 |
| 7 | Commissioning | 21 |
| 7.1 | Precautions when commissioning..... | 21 |
| 7.2 | Checklist before commissioning..... | 21 |
| 7.3 | Final check..... | 22 |

| | | |
|----------|-------------------------------------|-----------|
| 8 | Troubleshooting | 22 |
| 8.1 | Error codes: Overview..... | 22 |
| 9 | Technical data | 23 |
| 9.1 | Service space: Outdoor unit..... | 23 |
| 9.2 | Piping diagram: Outdoor module..... | 23 |
| 9.3 | Wiring diagram: Outdoor unit..... | 25 |

| | | |
|---------------------|--|-----------|
| For the user | | 26 |
| 10 | About the system | 26 |
| 10.1 | System layout..... | 26 |
| 11 | User interface | 26 |
| 12 | Operation | 27 |
| 12.1 | Operation range..... | 27 |
| 12.2 | Quick start-up..... | 27 |
| 12.3 | Operating the system..... | 28 |
| 12.3.1 | About the clock..... | 28 |
| 12.3.2 | About operating the system..... | 29 |
| 12.3.3 | Space cooling operation..... | 29 |
| 12.3.4 | Space heating operation..... | 29 |
| 12.3.5 | Other operation modes..... | 30 |
| 12.3.6 | Schedule timer..... | 30 |
| 12.3.7 | Operating the optional demand PCB..... | 34 |
| 12.3.8 | Operating the optional external control adapter..... | 34 |
| 12.3.9 | Operating the optional remote controller..... | 35 |
| 13 | Maintenance and service | 35 |
| 13.1 | About the refrigerant..... | 35 |
| 13.2 | After-sales service and warranty..... | 35 |
| 13.2.1 | Warranty period..... | 35 |
| 13.2.2 | Recommended maintenance and inspection..... | 35 |
| 14 | Troubleshooting | 35 |
| 14.1 | Error codes: Overview..... | 36 |
| 15 | Relocation | 36 |
| 16 | Disposal | 36 |

1 About the documentation

1.1 About this document



INFORMATION

Make sure that the user has the printed documentation and ask him/her to keep it for future reference.

Target audience

Authorised installers + end users



INFORMATION

This appliance is intended to be used by expert or trained users in shops, in light industry and on farms, or for commercial use by lay persons.

Documentation set

This document is part of a documentation set. The complete set consists of:

- **General safety precautions:**
 - Safety instructions that you must read before installing
 - Format: Paper (in the box of the outdoor unit)

- **Outdoor unit installation and operation manual:**
 - Installation and operation instructions
 - Format: Paper (in the box of the outdoor unit)
- **Installer and user reference guide:**
 - Preparation of the installation, reference data,...
 - Detailed step-by-step instructions and background information for basic and advanced usage
 - Format: Digital files on <http://www.daikineurope.com/support-and-manuals/product-information/>

Latest revisions of the supplied documentation may be available on the regional Daikin website or via your dealer.

The original documentation is written in English. All other languages are translations.

Technical engineering data

- A **subset** of the latest technical data is available on the regional Daikin website (publicly accessible).
- The **full set** of latest technical data is available on the Daikin extranet (authentication required).

For the installer

2 About the box

2.1 Outdoor unit

2.1.1 To remove the accessories from the outdoor unit

Make sure that all accessories are available in the unit.

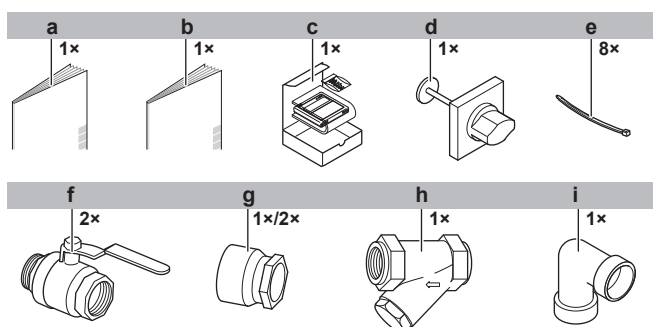

- a General safety precautions
- b Installation manual and operation manual (panel 3)
- c Remote controller (panel 3)
- d Main switch handle (panel 1)
- e Tie wraps (panel 3)
- f Shut-off valves (panel 3)
- g Threaded connection (panel 3) (1x for EWAQ +EWYQ016~032, 2x for EWAQ+EWYQ040~064)
- h Filter (panel 3)
- i Elbow (panel 3)

- In cooling mode, the refrigerant transports the heat taken from the water heat exchanger to the air heat exchanger where the heat is released to the air.
- In heating mode, the refrigerant transports the heat taken from the air heat exchanger to the water heat exchanger where the heat is released to the water.

3.2 System layout

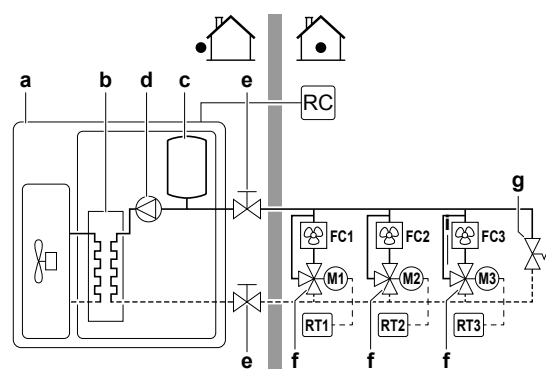

- a Outdoor unit
- b Plate heat exchanger
- c Expansion vessel
- d Pump
- e Shut-off valve
- f Motorized valve
- g Bypass valve
- FC1...3 Fancoil unit (field supply)
- RC Remote controller
- RT1...3 Room thermostat

3 About the units and options

3.1 About the outdoor unit

This installation manual concerns the packaged air-cooled water chiller. The unit is intended for outdoor installation and can be combined with fan coil units for air conditioning purposes, or it can be used for supplying water for process cooling applications.

The units are available in 7 standard sizes with nominal capacities ranging from 16.8 to 63 kW. All sizes are available as cooling only unit (EWAQ) and as heat pump unit (EWYQ: cooling/heating).

The unit is designed to work in heating mode at ambient temperatures from -15°C to 35°C and in cooling mode at ambient temperatures from -15°C to 43°C .

The main components are the compressor, the air heat exchanger, and the water heat exchanger.

The compressor circulates refrigerant into the heat exchangers.

4 Preparation

4.1 Preparing installation site

4.1.1 Installation site requirements of the outdoor unit

Mind the spacing guidelines. See the "Technical data" chapter.



CAUTION

Appliance not accessible to the general public, install it in a secured area, protected from easy access.

This unit, both indoor and outdoor, is suitable for installation in a commercial and light industrial environment.

4 Preparation



CAUTION

Appliance NOT accessible to the general public, install it in a secured area, protected from easy access.

This unit is suitable for installation in a commercial and light industrial environment.

4.2 Preparing water piping

4.2.1 Water circuit requirements



NOTICE

In case of plastic pipes, make sure they are fully oxygen diffusion tight according to DIN 4726. The diffusion of oxygen into the piping can lead to excessive corrosion.

- **Connecting piping – Legislation.** Make all piping connections in accordance with the applicable legislation and the instructions in the "Installation" chapter, respecting the water inlet and outlet.
- **Connecting piping – Force.** Do NOT use excessive force when connecting the piping. Deformation of the piping can cause malfunctioning of the unit.
- **Connecting piping – Tools.** Only use appropriate tooling to handle brass, which is a soft material. If NOT, pipes will get damaged.
- **Connecting piping – Air, moisture, dust.** If air, moisture or dust gets into the circuit, problems may occur. To prevent this:
 - Only use clean pipes
 - Hold the pipe end downwards when removing burrs.
 - Cover the pipe end when inserting it through a wall, to prevent dust and/or particles entering the pipe.
 - Use a decent thread sealant to seal connections.



NOTICE

If glycol is present in the system, make sure the thread sealant used is resistant to glycol.

- **Closed circuit.** Use the outdoor unit ONLY in a closed water system. Using the system in an open water system will lead to excessive corrosion.
- **Water flow.** You can find the minimum required water flow in the following table. In all cases, this flow needs to be guaranteed. When the flow is lower, operation will stop and error *FE* will be displayed.

| Capacity class | Minimum required flow rate |
|----------------|----------------------------|
| 016+021+025 | 23 l/min |
| 032 | 36 l/min |
| 040+050 | 46 l/min |
| 064 | 72 l/min |

- **Field supply components – Water pressure and temperature.** Check that all components in the field piping can withstand the water pressure and water temperature.
- **Drainage – Low points.** Provide drain taps at all low points of the system in order to allow complete drainage of the water circuit.
- **Non-brass metallic piping.** When using non-brass metallic piping, insulate the brass and non-brass properly so that they do NOT make contact with each other. This to prevent galvanic corrosion.
- **Shut-off valves.** Two shut-off valves are delivered with the unit. Install them as shown in the following figure.

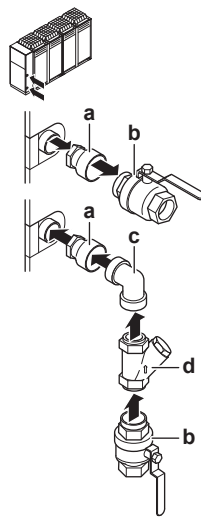

- a Adapter piece (on the inlet only in case of EWAQ +EWYQ040~064)
- b Shut-off valve
- c Bend
- d Filter



NOTICE

Before mounting the bend, attach the filter to it.



NOTICE

If the bend is not used during installation, replace it with an extension (5 cm long for a 1/4" filter, and 6 cm long for a 2" filter) to ensure proper cleaning operation of the filter.



NOTICE

Be sure to install the filter properly. Failure to install or incorrect installation will damage the plate heat exchanger permanently.

- **Drain taps.** Drain taps must be provided at all low points of the system to permit complete drainage of the circuit. A drain valve is provided inside the unit.
- **Air vents.** Provide air vents at all high points of the system, which must also be easily accessible for servicing. An automatic air purge valve is provided inside the unit. Check that this air purge valve is NOT tightened too much, so that automatic release of air from the water circuit is possible. Refer to field setting [E-04] in "6.2.9 Field settings on the remote controller" on page 16.



WARNING

- For correct operation of the system, a regulating valve must be installed in the water system. The regulating valve is to be used to regulate the water flow in the system (field supply).
- Selecting a flow outside the curves can cause malfunction or damage to the unit. Also refer to the Technical specifications.

- The maximum water piping temperature is 50°C according to safety device setting.
- Always use materials which are compatible with the water used in the system and with the materials used in the unit. (The unit piping fittings are made of brass, the plate heat exchangers are made of stainless steel 316 plates brazed together with copper and the optional pump housing is made of cast iron.)
- Select the piping diameter in relation to the required water flow and available external static pressure (ESP) of the pump. See the following table for the recommended water piping diameter.

| Capacity class | Water piping diameter |
|----------------|-----------------------|
| 016~032 | 1-1/4" |

| Capacity class | Water piping diameter |
|----------------|-----------------------|
| 040~064 | 2" |



NOTICE

It is strongly recommended to install an additional filter on the water circuit. Especially to remove metallic particles from the field water piping, it is advised to use a magnetic or cyclone filter which can remove small particles. Small particles can damage the unit and will not be removed by the standard filter of the unit.

- **Water pressure.** Take care that the components installed in the field piping can withstand the water pressure (maximum 3 bar + static pressure of the pump).

4.2.2 Formula to calculate the expansion vessel pre-pressure

The pre-pressure (Pg) of the vessel depends on the installation height difference (H):

$$Pg = 0.3 + (H/10) \text{ (bar)}$$

4.2.3 To check the water volume and expansion vessel pre-pressure

The unit has an expansion vessel of 12 litre with a default pre-pressure of 1 bar.

See the installer and user reference guide for more information.

To make sure that the unit operates properly:

- You must check the minimum and maximum water volume.
- You might need to adjust the pre-pressure of the expansion vessel.

Minimum water volume

| Cooling only model | Minimum total water volume (l) |
|--------------------|--------------------------------|
| 016~032 | 33 |
| 040~064 | 66 |

| Heat pump model | Minimum total water volume (l) |
|-----------------|--------------------------------|
| 016~025 | 76 |
| 032 | 110 |
| 040+050 | 152 |
| 064 | 220 |



INFORMATION

In critical processes, or in rooms with a high heat load, extra water might be required.



INFORMATION

The temperature step difference can be modified using settings [A-02] and [F-00]. This has an impact on the minimum water volume required when the unit operates in cooling.

By default, the unit is set to have a water temperature difference of 3.5 K which allows it to operate with the minimum volume mentioned in the previous table. However, if a smaller temperature differential is set, as in the case of process cooling applications where temperature fluctuations must be avoided, a larger minimum water volume will be required.

To ensure proper operation of the unit when changing the values of setting [F-00] (for cooling mode), the minimum water volume has to be corrected. If this volume exceeds the range allowed in the unit, an additional expansion vessel or a buffer tank must be installed in the field piping.

Example:

To illustrate the impact on the system when modifying the setting [F-00], we will consider a unit with a minimum allowable water volume of 66 l. The unit is installed 5 m below the highest point in the water circuit and is charged with 30% of ethylene glycol.

Assuming that the setting [F-00] is changed from 5°C (default value) to 0°C. From the below table we see that 5°C corresponds to a temperature differential of 3.5 K and 0°C to 1 K, which is actually the lowest value we can set.

| [F-00] value (°C) | Temperature differential (K) |
|-------------------|------------------------------|
| 0 | 1 |
| 1 | 1.5 |
| 2 | 2 |
| 3 | 2.5 |
| 4 | 3 |
| 5 | 3.5 |
| 6 | 4 |
| 7 | 4.5 |
| 8 | 5 |
| 9 | 5.5 |
| 10 | 6 |
| 11 | 6.5 |
| 12 | 7 |
| 13 | 7.5 |
| 14 | 8 |
| 15 | 8.5 |

The water volume correction factor according to the curve shown in the below graph is 3.5; this means that the minimum volume will be 3.5 times larger.

Correction factor curve for minimum water volume

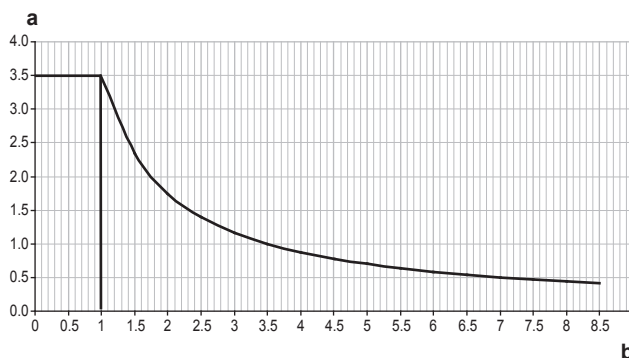

- a Water volume correction factor
- b Temperature differential (K)

When multiplying 64 l by the correction factor, we get 224 l, which will be the minimum water volume allowed in the installation if a temperature differential of 1 K is used.

Now it is very important to check that for the height difference of the system, the volume in the system is less than the maximum allowed value at that pre-pressure (Pg). If we take a look at the ethylene glycol concentration curve of 30%, for 1 bar of pre-pressure the maximum volume allowed is 240 l.

The total volume in the system will definitely be larger after adding the internal volume of the unit. In this case, some pre-pressure can be applied or an additional expansion vessel or buffer tank must be installed in the field piping.

Maximum water volume

Use the following graph to determine the maximum water volume for the calculated pre-pressure.

5 Installation

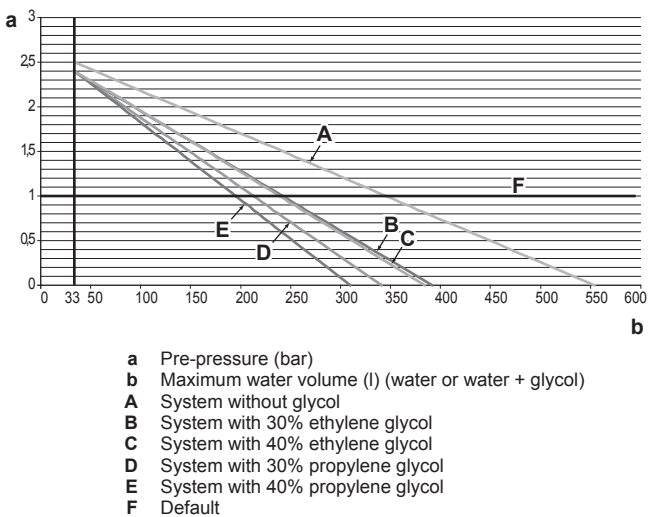

If the total water volume in the entire circuit exceeds the maximum allowed water volume (see graph), an additional expansion vessel must be installed in the field piping.

The default value of pre-pressure (P_g) is for a height difference of 7 m.

If the height difference of the system is lower than 7 m AND the volume in the system is less than the maximum allowed value at that pre-pressure (P_g) (see graph), then NO pre-pressure (P_g) adjustment is required.

4.2.4 Changing the pre-pressure of the expansion vessel



NOTICE

Only a licensed installer may adjust the pre-pressure of the expansion vessel.

When changing the default pre-pressure of the expansion vessel (1 bar) is required, take following guidelines into account:

- Only use dry nitrogen to set the expansion vessel pre-pressure.
- Inappropriate setting of the expansion vessel pre-pressure will lead to malfunction of the system.

Changing the pre-pressure of the expansion vessel should be done by releasing or increasing nitrogen pressure through the Schrader valve of the expansion vessel.

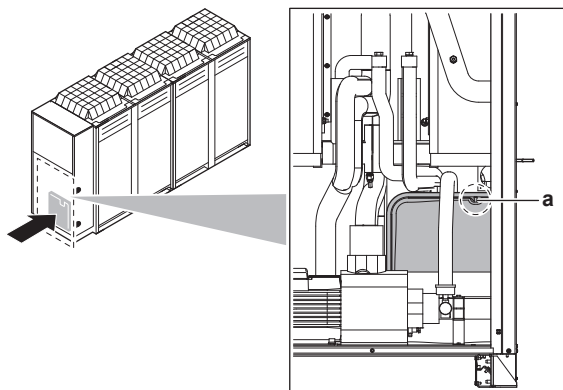

a Schrader valve

4.2.5 To check the water volume: Examples

Example 1

The unit is installed 5 m below the highest point in the water circuit. The total water volume in the water circuit is 250 l.

No actions or adjustments are required.

Example 2

The unit is installed at the highest point in the water circuit. The total water volume in the water circuit (no glycol used) is 420 l.

Actions:

- Because the total water volume (420 l) is more than the default water volume (340 l), the pre-pressure must be decreased.
- The required pre-pressure is:
 $P_g = (0.3 + (H/10)) \text{ bar} = (0.3 + (0/10)) \text{ bar} = 0.3 \text{ bar}$
- The corresponding maximum water volume is approximately 490 l (see graph).
- Because 420 l is lower than 490 l, the expansion vessel is appropriate for the installation.

4.3 Preparing electrical wiring

4.3.1 Safety device requirements

The power supply must be protected with the required safety devices, i.e. a main switch, a slow blow fuse on each phase and an earth leakage protector in accordance with the applicable legislation.

Selection and sizing of the wiring should be done in accordance with the applicable legislation based on the information mentioned in the table below.

| Model | Recommended fuses |
|--------------|-------------------|
| EWAQ/EWYQ016 | 25 A |
| EWAQ/EWYQ021 | 32 A |
| EWAQ/EWYQ025 | 32 A |
| EWAQ/EWYQ032 | 40 A |
| EWAQ/EWYQ040 | 50 A |
| EWAQ/EWYQ050 | 63 A |
| EWAQ/EWYQ064 | 80 A |



NOTICE

When using residual current operated circuit breakers, be sure to use a high-speed type 300 mA rated residual operating current.

5 Installation

5.1 Opening the units

5.1.1 To open the outdoor unit



DANGER: RISK OF ELECTROCUTION



DANGER: RISK OF BURNING

To gain access to the unit, front plates need to be opened as follows:

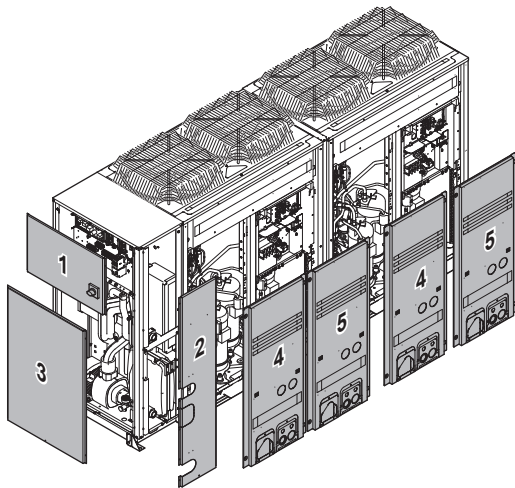

| Panel | |
|-------|--------------------------------------|
| 1 | Electrical parts of the hydro module |
| 2 | Hydro module (side panel) |
| 3 | Hydro module (front panel) |
| 4 | Outdoor module (left panel) |
| 5 | Outdoor module (right panel) |

Once the front plates open, the electrical component box can be accessed. See "5.1.2 To open the electrical component box of the outdoor unit" on page 9.

For service purposes, the pushbuttons on the main PCB need to be accessed. To access these pushbuttons, the electrical component box cover does not need to be opened. See "6.2.3 To access the field setting components" on page 14.

5.1.2 To open the electrical component box of the outdoor unit



NOTICE

Do NOT apply excessive force when opening the electronic component box cover. Excessive force can deform the cover, resulting in entering of water to cause equipment failure.

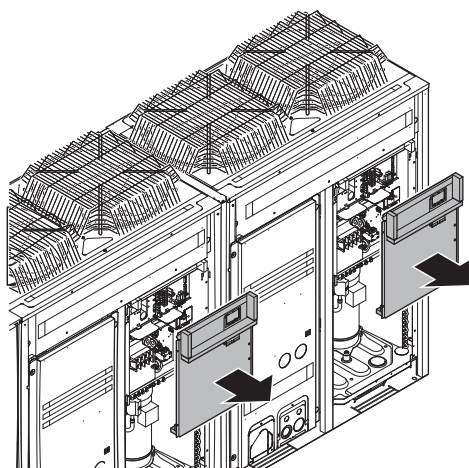

5.2 Mounting the outdoor unit

5.2.1 To provide the installation structure

Make sure the unit is installed level on a sufficiently strong base to prevent vibration and noise.



NOTICE

When the installation height of the unit needs to be increased, do NOT use stands to only support the corners.

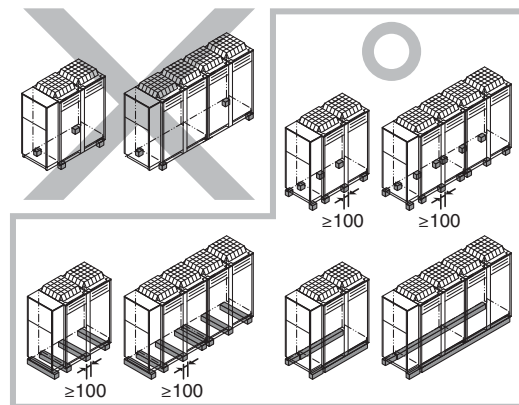

- X Not allowed
- O Allowed (* = preferred installation)

- The height of the foundation must at least be 150 mm from the floor. In heavy snowfall areas, this height should be increased, depending on the installation place and condition.
- The preferred installation is on a solid longitudinal foundation (steel beam frame or concrete). The foundation must be larger than the grey marked area.

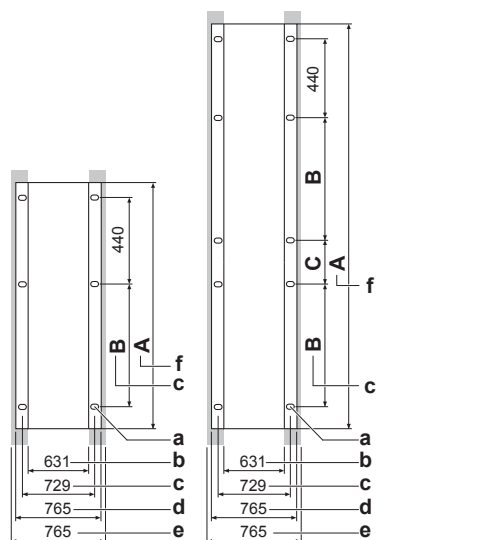

- Minimum foundation
- a Hole for foundation bolt
- b Base inner dimension
- c Distance between foundation bolt holes
- d Depth of unit
- e Base outer dimension
- f Longitudinal foundation dimension

| kW | A | B | C |
|-------|------|------|-----|
| 16~25 | 1340 | 792 | — |
| 32 | 1650 | 1102 | — |
| 40+50 | 2320 | 792 | 192 |
| 64 | 2940 | 1102 | 192 |

- Fasten the unit in place using four foundation bolts M12. It is best to screw in the foundation bolts until their length remains 20 mm above the foundation surface.

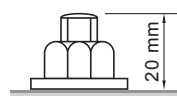

5 Installation

NOTICE

- Prepare a water drainage channel around the foundation to drain waste water from around the unit. During heating operation and when the outdoor temperatures are negative, the drained water from the outdoor unit will freeze up. If the water drainage is not taken care of, the area around the unit might be very slippery.
- When installed in a corrosive environment, use a nut with plastic washer (a) to protect the nut tightening part from rust.

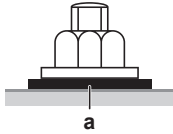

5.3 Connecting the water piping

5.3.1 Precautions when connecting the water piping

INFORMATION

Also read the precautions and requirements in the following chapters:

- General safety precautions
- Preparation

To connect the water piping

Water connections must be made in accordance with all applicable legislations and the outlook drawing delivered with the unit, respecting the water inlet and outlet.

NOTICE

Do NOT use excessive force when connecting the piping. Deformation of the piping can cause malfunctioning of the unit.

If dirt gets in the water circuit, problems may occur. Therefore, always take into account the following when connecting the water circuit:

- Use clean pipes only.
- Hold the pipe end downwards when removing burrs.
- Cover the pipe end when inserting it through a wall so that no dust and dirt enter.
- Use a good thread sealant for the sealing of the connections. The sealing must be able to withstand the pressures and temperatures of the system; it must also be resistant to the used glycol in the water.
- When using non-brass metallic piping, make sure to insulate both materials from each other to prevent galvanic corrosion.
- Make sure to provide a proper drain for the pressure relief valve.
- Because brass is a soft material, use appropriate tooling for connecting the water circuit. Inappropriate tooling will cause damage to the pipes.

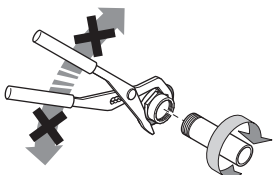

- For correct operation of the system, a regulating valve must be installed in the water system. The regulating valve is to be used to regulate the water flow in the system (field supply).

5.3.2 To fill the water circuit

- 1 Connect the water supply to the drain and fill valve.
- 2 Make sure the automatic air purge valve is open (at least 2 turns).
- 3 Fill with water until the pressure gauge indicates a pressure of approximately 2.0 bar. Remove air in the circuit as much as possible using the air purge valves (refer to field setting [E-04] in "6.2.9 Field settings on the remote controller" on page 16).

NOTICE

- Air in the water circuit can cause malfunctioning. During filling, it may not be possible to remove all the air from the circuit. Remaining air will be removed through the automatic air purge valves during the initial operating hours of the system. Additional filling with water afterwards may be required.
- To purge the system, use the special function as described in "7 Commissioning" on page 21.

NOTICE

The water pressure indicated on the manometer will vary depending on the water temperature (higher pressure at higher water temperature).

However, at all times water pressure shall remain above 1 bar to avoid air entering the circuit.

NOTICE

Make sure water quality complies with EU directive 98/83 EC.

INFORMATION

The unit may dispose of some excessive water through the pressure relief valve.

NOTICE

In case of a power supply failure or pump failure, and NO glycol was added to the system, drain the system. When water is at standstill inside the system, the system is very likely to freeze and get damaged.

5.3.3 To protect the water circuit against freezing

Frost can damage the system. For this reason, if negative ambient temperatures are expected, make sure the water circuit is sufficiently protected against freezing.

Heater tape (optional)

A heater tape is wound around the piping to protect vital parts of the hydraulic system inside the unit.

This heater tape will only protect internal parts of the unit. It can not protect field installed parts outside the unit.

Field heater tapes must be provided by the installer.

NOTICE

In case of a power failure or if the power supply is disconnected during winter, the optional heater tape cannot protect the unit from freezing. If a power failure can happen at times the unit is unattended, if the power supply is disconnected during winter, or if you did not select this option, it is recommended to add glycol to the water system.

Glycol

Refer to field setting [8-04] in "6.2.9 Field settings on the remote controller" on page 16.

i INFORMATION

The concentrations mentioned in the table below will prevent the piping from bursting, but will not prevent the liquid in the piping from freezing.

Depending on the expected lowest outdoor temperature, make sure the water system is filled with a weight concentration of glycol as mentioned in the following table.

| Minimum outdoor temperature | Ethylene glycol | Propylene glycol |
|-----------------------------|-----------------|------------------|
| -5°C | 10% | 15% |
| -10°C | 15% | 20% |
| -15°C | 20% | 35% |

! WARNING

Ethylene glycol is toxic.

! NOTICE

The above mentioned concentrations are applicable only when the unit is at a standstill.

! CAUTION

- In case of over-pressure when using glycol, be sure to connect the safety valve to a drain pan in order to recover the glycol. Connecting a drain pipe is not required if no glycol is used. The discharged water is then drained via the bottom of the unit.
- Using more than 40% glycol will damage the unit.

! WARNING

Due to presence of glycol, corrosion of the system is possible. Uninhibited glycol will turn acidic under the influence of oxygen. This process is accelerated by the presence of copper and high temperatures. The acidic uninhibited glycol attacks metal surfaces and forms galvanic corrosion cells that cause severe damage to the system. Therefore it is important that:

- the water treatment is correctly executed by a qualified water specialist,
- a glycol with corrosion inhibitors is selected to counteract acids formed by the oxidation of glycols,
- no automotive glycol is used because their corrosion inhibitors have a limited lifetime and contain silicates which can foul or plug the system,
- galvanized pipes are NOT used in glycol systems since the presence may lead to the precipitation of certain components in the glycol's corrosion inhibitor.

! NOTICE

Glycol absorbs water from its environment. Therefore do NOT add glycol that has been exposed to air. Leaving the cap off the glycol container causes the concentration of water to increase. The glycol concentration is then lower than assumed. As a result, the hydraulic components might freeze up after all. Take preventive actions to ensure a minimal exposure of the glycol to air.

See also "7.3 Final check" on page 22.

5.3.4 To insulate the water piping

The complete water circuit, inclusive all piping, must be insulated to prevent condensation during cooling operation and reduction of the heating and cooling capacity as well as prevention of freezing of the outside water piping during winter time. The thickness of the insulation materials must be at least 13 mm with $\lambda=0.039$ W/mK in order to prevent freezing of the outside water piping at ambient temperature of -15°C.

If the temperature is higher than 30°C and the humidity is higher than RH 80%, the thickness of the insulation materials should be at least 20 mm to prevent condensation on the surface of the insulation.

5.4 Connecting the electrical wiring

5.4.1 Field wiring: Overview

Field wiring consists of power supply (always including earth) and indoor-outdoor communication (= transmission) wiring.

- Most field wiring on the unit is to be made on the terminal blocks inside the electrical component boxes. To gain access to the terminal blocks, remove the electrical component box service panel. See "5.1 Opening the units" on page 8.
- Cable tie mountings are provided at the wiring entries of the electrical component box.

The wiring diagram is delivered with the unit, located at the inside of the switch box cover.

5.4.2 To route and fix the power supply

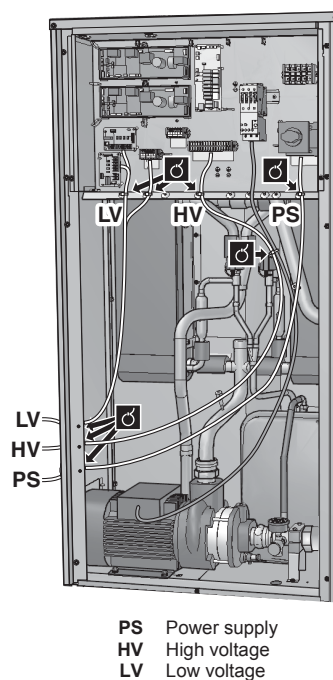

5.4.3 To install the main switch handle

Open panel 1 and mount the main switch handle parts. The handle of the main switch is mounted on panel 1.

EWAQ+EWYQ016-032

5 Installation

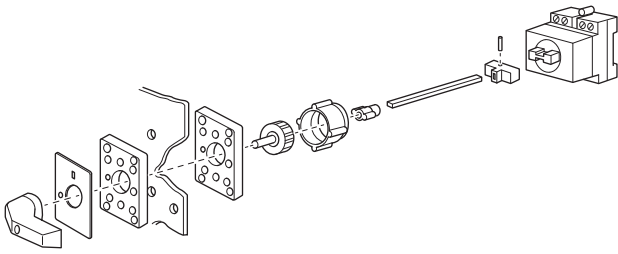

EWAQ+EWYQ040~064

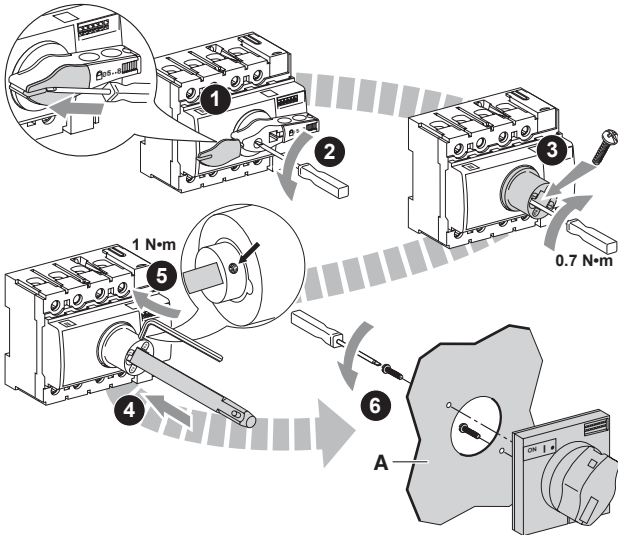

NOTICE

When the main switch is in the OFF position, it is possible to lock the main switch using a suitable padlock. See the figure below.

Keep in mind that in this case the padlock needs to be opened and removed before it is possible to turn the main switch to the ON position.

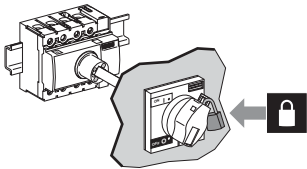

5.4.4 To connect the power supply and transmission cables

- 1 Open the electrical component box cover.
- 2 Using the appropriate cable, connect the power supply and communication cable(s) to the appropriate terminals as shown on the wiring diagram.
- 3 Fix the cables with cable ties to the cable tie mountings to ensure strain relief and to make sure that they do not come in contact with the piping and sharp edges. Never squeeze bundled cables.
- 4 Close the electrical component box cover.

5.4.5 To install the remote controller

The unit comes with a remote controller offering a user-friendly way to set up, use and maintain the unit. Before operating the remote controller, follow this installation procedure.

| Wire specification | Value |
|--------------------|---------------------------|
| Type | 2 wire |
| Section | 0.75~1.25 mm ² |

| Wire specification | Value |
|--------------------|-------|
| Maximum length | 500 m |

NOTICE

The wiring for connection is NOT included.

NOTICE

The accessory remote controller MUST be mounted indoors.

- 1 Insert a slotted screwdriver into the slots in the rear part of the remote controller, and remove the front part of the remote controller.

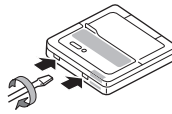

- 2 Fasten the remote controller on a flat surface.

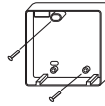

NOTICE

Be careful NOT to distort the shape of the lower part of the remote controller by overtightening the mounting screws.

- 3 Connect the terminals of the remote controller and the terminals inside the unit (P1 to P1, P2 to P2) as shown in the figure.

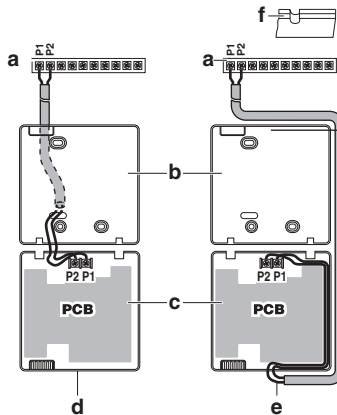

- a Unit
- b Rear part of the remote controller
- c Front part of the remote controller
- d Wired from the rear
- e Wired from the top
- f Use nippers to notch the part for the wiring to pass through

NOTICE

- When wiring, run the wiring away from the power supply wiring in order to avoid receiving electric noise (external noise).
- Peel the shield for the part that has to pass through the inside of the remote controller case (L).

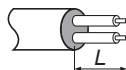

- 4 Reattach the upper part of the remote controller, starting with the clips at the bottom.

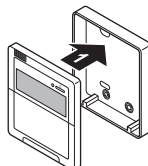

**CAUTION**

Do NOT pinch the wiring when attaching.

If, in addition to the standard remote controller, an optional remote controller (EKRUHTB) is installed as well:

- 5 Connect the electrical wires of both remote controllers as described.
- 6 Select a master and a slave remote controller using the SS1 selector switch.

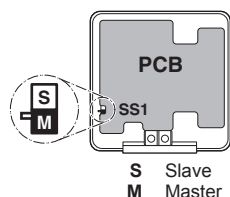
**INFORMATION**

Only the remote controller set as master can be used as a room thermostat.

**INFORMATION**

For multi unit control, connect the remote controller to the unit as instructed above. For all other units to be controlled by this controller, connect P1 of the previous unit to P1 of the next unit, P2 of the previous unit to P2 of the next unit, etc.

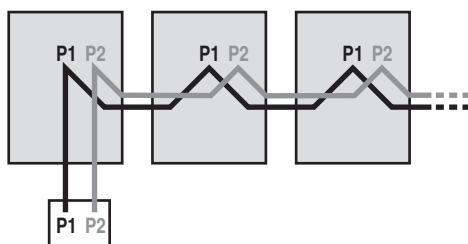

This is limited to 16 PCBs, with EWAQ+EWYQ016~032 counting as 1 PCB, and EWAQ+EWYQ040~064 as 2 PCBs.

5.4.6 To install optional equipment

For the installation of optional equipment, refer to the installation manual which is delivered with the optional equipment or the addenda delivered with this unit.

6 Configuration**INFORMATION**

It is important that all information in this chapter is read sequentially by the installer and that the system is configured as applicable.

**DANGER: RISK OF ELECTROCUTION****6.1 Overview: Configuration**

This chapter describes what you have to do and know to configure the system after it is installed.

It contains information about:

- Making field settings
- Switching between cooling and heating

**INFORMATION**

It is important that all information in this chapter is read sequentially by the installer and that the system is configured as applicable.

**DANGER: RISK OF ELECTROCUTION****6.2 Making field settings****6.2.1 About making field settings****INFORMATION**

The LEDs and buttons are located in the outdoor module (not in the hydro module).

Making settings is done via the master unit.

Next to making field settings it is also possible to confirm the current operation parameters of the unit.

Pushbuttons and DIP switches

| Item | Description |
|--------------|---|
| Pushbuttons | By operating the pushbuttons it is possible to: <ul style="list-style-type: none"> • Change the mode. • Perform field settings (demand operation, low noise, etc). |
| DIP switches | <ul style="list-style-type: none"> • DS1 (1): COOL/HEAT selector • DS1 (2~4): NOT USED. DO NOT CHANGE THE FACTORY SETTING. • DS2 (1~4): NOT USED. DO NOT CHANGE THE FACTORY SETTING. |

See also:

- ["6.2.2 Field setting components" on page 14](#)
- ["6.2.3 To access the field setting components" on page 14](#)

Mode 1 and 2

| Mode | Description |
|---------------------------------|---|
| Mode 1 (monitoring settings) | Mode 1 can be used to monitor the current situation of the outdoor unit. Some field setting contents can be monitored as well. |
| Mode 2 (field settings) | <p>Mode 2 is used to change the field settings of the system. Consulting the current field setting value and changing the current field setting value is possible.</p> <p>In general, normal operation can be resumed without special intervention after changing field settings.</p> <p>Some field settings are used for special operation (e.g., 1 time operation, recovery/vacuuming setting, manual adding refrigerant setting, etc.). In such a case, it is required to abort the special operation before normal operation can restart. It will be indicated in below explanations.</p> |

See also:

- ["6.2.4 To access mode 1 or 2" on page 14](#)
- ["6.2.5 To use mode 1" on page 14](#)
- ["6.2.6 To use mode 2" on page 15](#)
- ["6.2.7 Mode 1: Monitoring settings" on page 15](#)
- ["6.2.8 Mode 2: Field settings" on page 15](#)

6 Configuration

To continue the configuration of the system, it is required to give some input to the PCB of the unit. This chapter will describe how manual input is possible by operating the pushbuttons/DIP switches on the PCB and reading the feedback from the LEDs.



INFORMATION

If you get confused in the middle of the process, push BS1. Then it returns to setting mode 1 (H1P is off).

6.2.2 Field setting components

The components to make field settings are as follows:

| MODE | TEST: | C/H SELECT | | | LN.O.P. | DEMAND | MULTI |
|------|-------|------------|--------|-------|---------|--------|-------|
| | H1P: | IND | MASTER | SLAVE | | | |
| H1P | H2P | H3P | H4P | H5P | H6P | H7P | H8P |

| | | | | |
|-------------|------------|---------------|-------------|--------------|
| BS1 MODE | BS2 SET | BS3 RETURN | BS4 TEST | BS5 RESET |
|-------------|------------|---------------|-------------|--------------|

BS1~BS5 Pushbuttons
H1P~H8P LEDs
ON OFF Flashing

Pushbuttons

Use the pushbuttons to make the field settings.

- BS1 MODE: For changing the set mode
- BS2 SET: For field setting
- BS3 RETURN: For field setting
- BS4 Not used
- BS5 Not used

LEDs

The LEDs give feedback about the field settings, which are defined as [Mode-Setting]=Value.

- H1P Shows the mode
- H2P~H7P Shows the settings and values, represented in binary code
- H8P NOT used for field settings, but used during initialisation

Example:

| [H1P- 32 + 16 + 8 + 4 + 2 + 1] H1P H2P H3P H4P H5P H6P H7P | Description |
|---|--------------------------------|
| | Default situation (H1P OFF) |
| | Mode 1 (H1P flashing) |
| | Mode 2 (H1P ON) |
| 0 + 0 + 8 + 0 + 0 + 0 | Setting 8 (in mode 2) |
| 0 + 0 + 0 + 4 + 0 + 0 | Value 4 (in mode 2) |

6.2.3 To access the field setting components

Remove the inspection cover to carry out field settings.

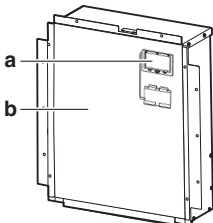

Operate the switches and pushbuttons with an insulated stick (such as a closed ball-point pen) to avoid touching of live parts.



Make sure to re-attach the inspection cover into the electrical component box cover after the job is finished.



NOTICE

Make sure that all outside panels, except for the service cover on the electrical component box, are closed while working.

Close the lid of the electrical component box firmly before turning on the power.

6.2.4 To access mode 1 or 2

After the units are turned ON, the display goes to its default situation. From there, you can access mode 1 and mode 2.

Initialisation: default situation



NOTICE

Be sure to turn on the power 6 hours before operation in order to have power running to the crankcase heater and to protect the compressor.

Turn on the power supply of the outdoor unit, and turn on the external operation switch. After initialisation, the display indication state will be as below (default situation when shipped from factory).

| | | H1P | H2P | H3P | H4P | H5P | H6P | H7P | H8P |
|-------------|--------------------|-----|-----|-----|-----|-----|-----|-----|-----|
| Single unit | | | | | | | | | |
| Multi-unit | Left unit (master) | | | | | | | | |
| | Right unit (slave) | | | | | | | | |

If the default situation is not displayed after 10~12 minutes, check the malfunction code. Solve the malfunction code accordingly.

The HAP LED flashes to indicate normal microcomputer operation.

Switching between modes

Use BS1 to switch between the default situation, mode 1 and mode 2.

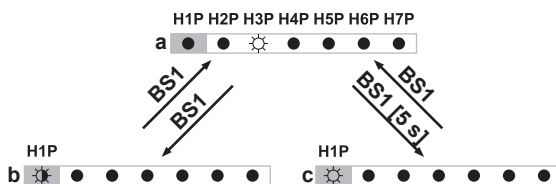

- a Default situation (H1P OFF)
- b Mode 1 (H1P flashing)
- c Mode 2 (H1P ON)
- BS1 Press BS1.
- BS1 [5 s] Press BS1 for at least 5 s.



INFORMATION

If you get confused in the middle of the process, press BS1 to return to the default situation.

6.2.5 To use mode 1

Mode 1 is used to monitor the status of the unit.

| What | How |
|--|--|
| Accessing monitoring mode 1 | Once mode 1 is selected (push BS1 one time), you can select the wanted setting. It is done by pushing BS2. |
| To quit and return to the initial status | Press BS1. |

6.2.6 To use mode 2

The master unit should be used to input field settings in mode 2.

Mode 2 is used to set field settings of the outdoor unit and system.

| What | How |
|--|---|
| Changing and accessing the setting in mode 2 | Once mode 2 is selected (push BS1 for more than 5 seconds), you can select the wanted setting. It is done by pushing BS2. Accessing the selected setting's value is done by pushing BS3 1 time. |
| To quit and return to the initial status | Press BS1. |
| Changing the value of the selected setting in mode 2 | <ul style="list-style-type: none"> Once mode 2 is selected (push BS1 for more than 5 seconds) you can select the wanted setting. It is done by pushing BS2. Accessing the selected setting's value is done by pushing BS3 1 time. Now BS2 is used to select the required value of the selected setting. When the required value is selected, you can define the change of value by pushing BS3 1 time. Press BS3 again to start operation according to the chosen value. |

6.2.7 Mode 1: Monitoring settings

In mode 1 (and in default situation) you can read out the following information:

| | Value / Description |
|----------|---|
| H2P | Shows the present operation state. |
| OFF | Normal operation state. |
| ON | Abnormal operation state. |
| FLASHING | Under preparation or under test preparation |











6.2.8 Mode 2: Field settings

Press the BS2 button to make field settings to configure the system. The LEDs give a binary representation of the setting/value number.

| Setting | H1P H2P H3P H4P H5P H6P H7P (= binary) | | | | | | | Value | | |
|--|--|-----|-----|-----|-----|-----|-----|--------------|------------|-------------------------|
| | H1P | H2P | H3P | H4P | H5P | H6P | H7P | Description | | |
| Fan high static pressure setting. In order to increase the static pressure the outdoor unit fan is delivering, this setting should be activated. | | | | | | | | Deactivated. | | |
| | | | | | | | | (default) | Activated. | |
| Automatic low noise setting and level during night time. By changing this setting, you activate the automatic low noise operation function of the unit and define the level of operation. Depending on the chosen level, the noise level will be lowered. | | | | | | | | Deactivated | | |
| | | | | | | | | (default) | Level 1 | Level 3<Level 2<Level 1 |
| | | | | | | | | (default) | Level 2 | |
| | | | | | | | | (default) | Level 3 | |

| | Value / Description |
|-----|--|
| H6P | Shows the status of low noise operation. |
| | OFF Unit is currently not operating under low noise restrictions. |
| H7P | ON Unit is currently operating under low noise restrictions. |
| | Low noise operation reduces the sound generated by the unit compared to nominal operating conditions. Low noise operation can be set in mode 2. There are two methods to activate low noise operation of the compressor unit and heat exchanger unit. <ul style="list-style-type: none"> The first method is to enable an automatic low noise operation during night time by field setting. The unit will operate at the selected low noise level during the selected time frames. The second method is to enable low noise operation based on an external input. For this operation an optional accessory is required. |
| H7P | Shows the status of power consumption limitation operation. |
| | OFF Unit is currently not operating under power consumption limitations. |
| H7P | ON Unit is currently operating under power consumption limitation. |
| | Power consumption limitation reduces the power consumption of the unit compared to nominal operating conditions. Power consumption limitation can be set in mode 2. There are two methods to activate power consumption limitation of the compressor unit. <ul style="list-style-type: none"> The first method is to enable a forced power consumption limitation by field setting. The unit will always operate at the selected power consumption limitation. The second method is to enable power consumption limitation based on an external input. For this operation an optional accessory is required. |

6 Configuration

| Setting H1P H2P H3P H4P H5P H6P H7P (= binary) | Value | | Description |
|---|--|--------------|-------------------------|
| | H1P H2P H3P H4P H5P H6P H7P | | |
|  Low noise operation level via the external control adaptor. If the system needs to be running under low noise operation conditions when an external signal is sent to the unit, this setting defines the level of low noise that will be applied. This setting will only be effective when the optional external control adaptor (DTA104A62) is installed and setting [2-12] was activated. |  | Level 1 | Level 3<Level 2<Level 1 |
| |  (default) | Level 2 | |
| |  | Level 3 | |
|  Power consumption limitation level via the external control adaptor (DTA104A62) If the system needs to be running under power consumption limitation conditions when an external signal is sent to the unit, this setting defines the level power consumption limitation that will be applied. The level is according to the table. |  | Level 1 | Level 3<Level 2<Level 1 |
| |  (default) | Level 2 | |
| |  | Level 3 | |
|  Enable the low noise function and/or power consumption limitation via the external control adaptor (DTA104A62). If the system needs to be running under low noise operation or under power consumption limitation conditions when an external signal is sent to the unit, this setting should be changed. This setting will only be effective when the optional external control adaptor (DTA104A62) is installed in the indoor unit. |  (default) | Deactivated. | |
| |  | Activated. | |

6.2.9 Field settings on the remote controller



The user can change the field settings using the remote controller.

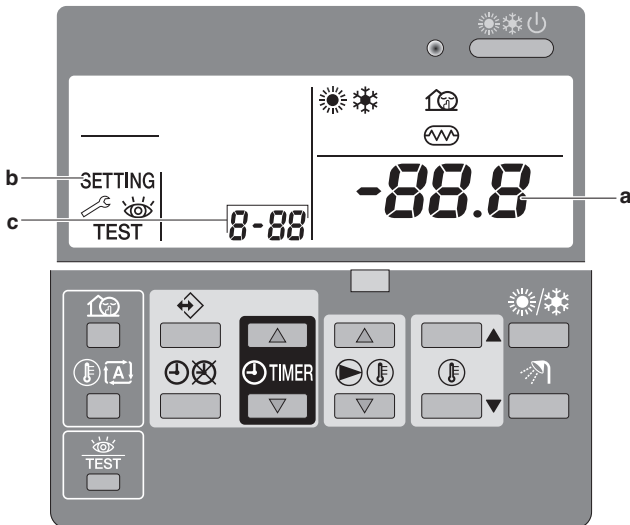



Each field setting is assigned a 3-digit number or code, e.g. [5-03], which is indicated on the remote controller display. The first digit [5] is the 'first code' or field setting group. The second and third digit [03] together are the 'second code'.





- 1 Press  for a minimum of 5 seconds to enter the field setting mode.

Result: SETTING (c), the current selected field setting code 8-88 (b) and the set value -88.8 (a) are displayed.

- 2 Press  to select the appropriate field setting first code.
- 3 Press  to select the appropriate field setting second code.

- 4 Press  and  to change the value of the selected field setting.
- 5 Press  to save the new value.
- 6 Repeat the previous steps to change other field settings as required.
- 7 When finished, press  to exit the field setting mode.

INFORMATION

- Changes made to a specific field setting are only stored when  is pressed. Navigating to a new field setting code or pressing  will discard any changes.
- Field settings are grouped by their first code, e.g. field settings [0-00]; [0-01]; [0-02]; [0-03] are defined as "Group 0". When different values are changed within the same group, pressing  will save all the values changed within this group.

INFORMATION

- Before shipping, the set values have been set as shown in "6.2.9 Field settings on the remote controller" on page 16.
- When exiting the field setting mode, "88" may be displayed on the remote controller LCD while the unit initializes itself.

[0] Remote control setup

[0-00] User permission level

The user permission level defines which buttons and functions are available for the user. By default no level is defined, so all buttons and functions are operable.

| [0-00] | Description |
|--------|--------------------|
| 2 | Permission level 2 |
| 3 | Permission level 3 |

| | Master | Slave | Permission level 2 | Permission level 3 |
|---------------------------------------|--------|-------|--------------------|--------------------|
| Operation ON/OFF | ✓ | ✓ | ✓ | ✓ |
| Setting the leaving water temperature | ✓ | ✓ | ✓ | — |

| | Master | Slave | Permission level 2 | Permission level 3 |
|---|--------|-------|--------------------|--------------------|
| Setting the room temperature | ✓ | ✓ | ✓ | ✓ |
| Quiet mode ON/OFF | ✓ | ✓ | — | — |
| Weather dependent setpoint operation ON/OFF | ✓ | ✓ | ✓ | — |
| Setting the clock | ✓ | ✓ | — | — |
| Programming the schedule timer | ✓ | — | — | — |
| Schedule timer operation ON/OFF | ✓ | — | ✓ | ✓ |
| Field settings | ✓ | — | — | — |
| Error code display | ✓ | ✓ | ✓ | ✓ |
| Test operation | ✓ | ✓ | — | — |

After entering the field setting, the selected permission level must be enabled by simultaneously pressing \ominus [▲] and \ominus [▼], immediately followed by simultaneously pressing Ⓜ and Ⓜ . Keep all 4 buttons pressed for at least 5 seconds. Note that no indication on the remote controller is given. After the procedure the blocked buttons will not be available anymore.

Deactivating the selected permission level is done in the same way.

[0-01] Room temperature compensation value

If necessary, it is possible to adjust some thermistor value of the unit by a correction value. This can be used as countermeasure for thermistor tolerances or capacity shortage.

The compensated temperature (= measured temperature plus compensation value) is then used to control the system and will be displayed in the temperature read-out mode. See also field setting [9] in this chapter for compensation values for leaving water temperature.

[0-02]

This setting is not applicable.

[0-03] Status

Defines whether the ON/OFF instruction can be used in the schedule timer for space heating.

| [0-03] | Description |
|-------------|---|
| 0 | Space heating schedule timer based on ON/OFF instruction. |
| 1 (default) | Space heating schedule timer based on temperature setpoint. |

| Space heating based on ON/OFF instruction | |
|---|---|
| During operation | When the schedule timer switches space heating OFF, the controller will be switched off (operation LED will stop working). |
| Press Ⓜ | <p>The schedule timer for space heating will stop (when active at that moment) and will start again at the next scheduled ON function.</p> <p>The "last" programmed command overrules the "preceding" programmed command and will remain active until the "next" programmed command occurs.</p> <p>Example: imagine the actual time is 17:30 and actions are programmed at 13:00, 16:00 and 19:00. The "last" programmed command (16:00) overruled the "previous" programmed command (13:00) and will remain active until the "next" programmed command (19:00) occurs.</p> <p>So in order to know the actual setting, you should consult the last programmed command (this may date from the day before).</p> <p>The controller is switched off (operation LED off), but the schedule timer icon remains on.</p> |

| Space heating based on ON/OFF instruction | |
|---|--|
| Press Ⓜ | <p>The schedule timer for space heating and the quiet mode stops and will not start again.</p> <p>The schedule timer icon is not displayed any more.</p> |

- Operation example: Schedule timer based on ON/OFF instruction. When the setback function (see field setting [2]) is enabled, the setback operation will have priority over the scheduled action in the schedule timer if ON instruction is active. If OFF instruction is active this will have priority over the setback function. At any time the OFF instruction will have the highest priority.

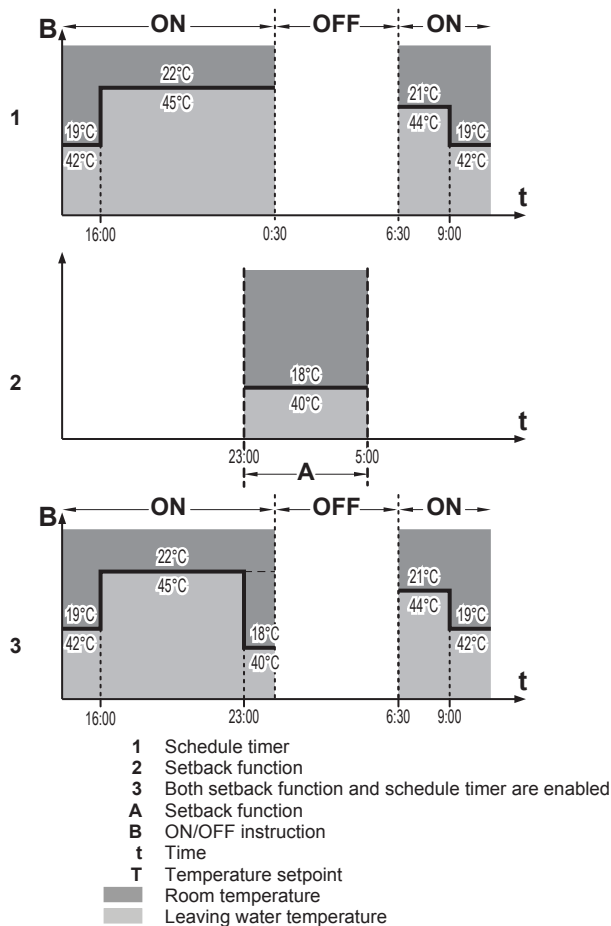

| Space heating based on temperature setpoint ^(a) | |
|--|--|
| During operation | During schedule timer operation the operation LED is lit continuously. |
| Press Ⓜ | <p>The schedule timer for space heating stops and will not start again.</p> <p>The controller is switched off (operation LED off).</p> |

6 Configuration

Space heating based on temperature setpoint^(a)

Press \otimes/\oplus

The schedule timer for space heating and the quiet mode stops and will not start again.

The schedule timer icon is not displayed any more.

(a) For leaving water temperature and/or room temperature

- Operation example: Schedule timer based on temperature setpoint

When the setback function (see field setting [2]) is enabled, the setback operation will have priority over the scheduled action in the schedule timer.

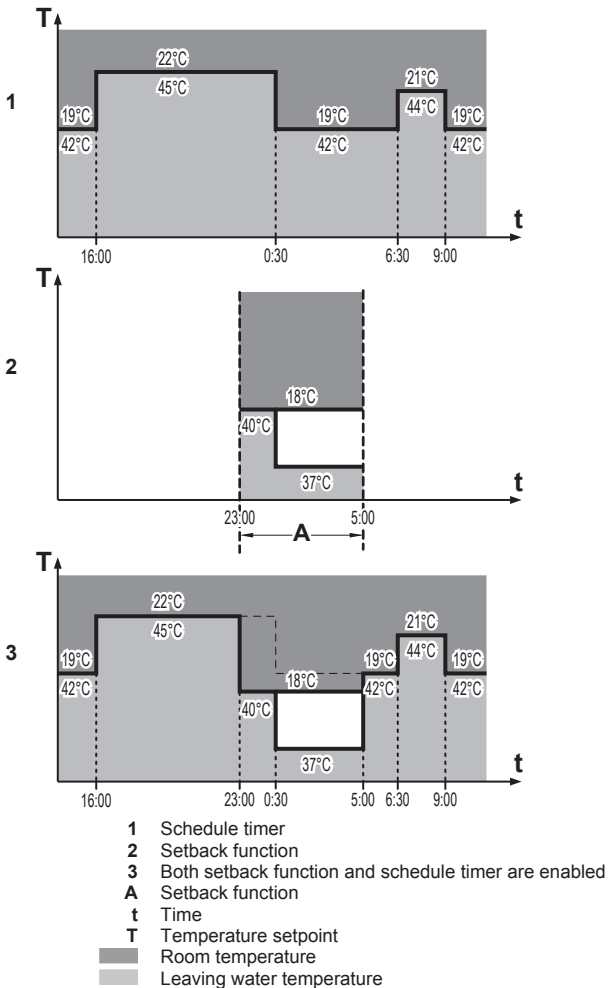

[0-04] Status

Defines whether the ON/OFF instruction can be used in the schedule timer for cooling.

This is the same as for space heating [0-03], but the setback function is not available.

[1] Settings are not applicable

[2] Automatic setback function



INFORMATION

This function is available for heat pump units operating in heating mode ONLY. It does NOT exist for cooling.

The setback function provides the possibility to lower the room temperature. It can be activated e.g. during the night, because temperature demands during night and day are not the same.



INFORMATION

- The setback function is enabled by default.
- The setback function can be combined with the automatic weather dependent setpoint operation.
- Setback function is an automatic daily scheduled function.

Setback configured for room temperature control

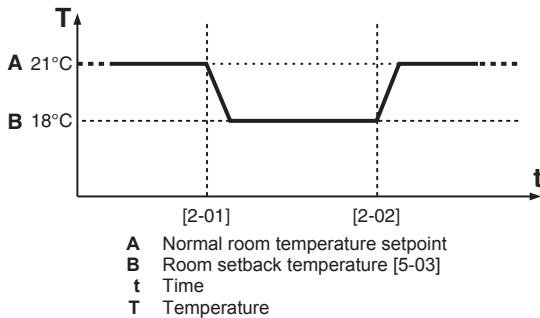

Setback configured for leaving water temperature control

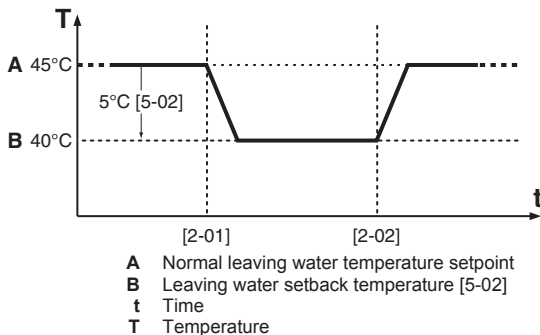

See field setting [5] in this chapter for temperature setpoints.

[2-00] Status

| [2-00] | Description |
|--------|-----------------------------------|
| 0 | The setback function is disabled. |
| 1 | The setback function is enabled. |

[2-01] Start time

Time at which setback is started.

[2-02] Stop time

Time at which setback is stopped.

[3] Weather dependent setpoint



INFORMATION

This function is available for heat pump units operating in heating mode ONLY. It does NOT exist for cooling.

When weather dependent operation is active, the leaving water temperature is determined automatically depending on the outdoor temperature: colder outdoor temperatures will result in warmer water and vice versa. The unit has a floating setpoint. Activating this operation will result in a lower power consumption than use with a manually fixed leaving water setpoint.

During weather dependent operation, the user has the possibility to shift up or down the target water temperature by a maximum of 5°C. This "Shift value" is the temperature difference between the temperature setpoint calculated by the controller and the real setpoint. E.g. a positive shift value means that the real temperature setpoint will be higher than the calculated setpoint.

It is advised to use the weather dependent setpoint because it adjusts the water temperature to the actual needs for space heating. It will prevent the unit from switching too much between thermo ON operation and thermo OFF operation when using the remote controller room thermostat or external room thermostat.

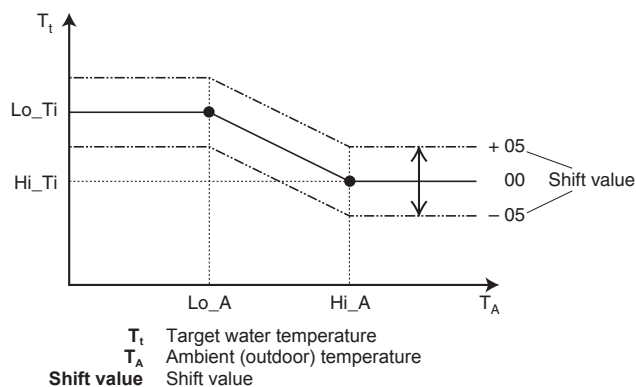

[3-00] Low ambient temperature (Lo_A)

Low outdoor temperature.

[3-01] High ambient temperature (Hi_A)

High outdoor temperature.

[3-02] Setpoint at low ambient temperature (Lo_Ti)

The target outgoing water temperature when the outdoor temperature equals or drops below the low ambient temperature (Lo_A).

Lo_Ti should be higher than Hi_Ti , as warmer water is required for colder outdoor temperatures.

[3-03] Setpoint at high ambient temperature (Hi_Ti)

The target outgoing water temperature when the outdoor temperature equals or rises above the high ambient temperature (Hi_A).

Hi_Ti should be lower than Lo_Ti , as less warm water suffices for warmer outdoor temperatures.



INFORMATION

If the value of [3-03] is mistakenly set higher than the value of [3-02], the value of [3-03] will always be used.

[4] Settings are not applicable

[5] Automatic setback

[5-00]

This setting is not applicable.

[5-01]

This setting is not applicable.

[5-02] Leaving water setback temperature

[5-03] Room setback temperature

[5-04]

This setting is not applicable.

[6] Option setup

[6-01] External room thermostat option

If an optional external room thermostat is installed, its operation must be enabled by this field setting.

The external room thermostat only gives an ON/OFF signal to the heat pump based on the room temperature. Because it does not give continuous feedback information to the heat pump, it is supplementary to the remote controller room thermostat function. To have a good control of the system and avoid frequent ON/OFF it is advised to use the automatic weather dependent setpoint operation.

| [6-01] | Description |
|-------------|--|
| 0 (default) | External room thermostat not installed. |
| 1 | External room thermostat input 1 = heating operation ON (1)/OFF (0). External room thermostat input 2 = cooling operation ON (1)/OFF (0). |
| 2 | External room thermostat input 1 = operation ON (1)/OFF (0). External room thermostat input 2 = cooling (1)/heating (0). |

[7] Option setup

[7-00] Forced pump operation

| [7-00] | Description |
|-------------|--|
| 0 | The pump performs intermittent sampling during thermo off conditions. This setting is often used when the unit is controlled by a room thermostat. |
| 1 (default) | The pump continues operation during thermo off conditions. |

[8] Option setup

[8-00] Remote controller temperature control

| [8-00] | Description |
|-------------|---|
| 0 (default) | The unit operates in leaving water temperature control. |
| 1 | The unit operates in room temperature control. This means that the remote controller is used as a room thermostat, so the remote controller can be placed in the living room to control the room temperature. |

Note: When the unit is operated in room temperature control (by remote controller or external room thermostat option), room temperature has priority over leaving water setpoint.

[8-01]

This setting is not applicable.

[8-03]

This setting is not applicable.

[8-04] Freeze-up prevention

Freeze-up prevention will be activated by starting up the pump to circulate the water, and if the leaving or return water temperature is $<5^{\circ}\text{C}$ for 5 minutes, the unit will start up in heating mode to prevent too low temperatures.

The freeze-up prevention is only active when the unit is in thermo OFF condition.

The option can be enabled when there is no optional heater tape or glycol in the system and when heat can be used from an application.

| [8-04] | Description |
|-------------|---|
| 0 (default) | No freeze-up prevention |
| 1 | Freeze-up prevention level 1 (outdoor temperature $<4^{\circ}\text{C}$ and leaving or return water temperature $<7^{\circ}\text{C}$) |
| 2 | Freeze-up prevention level 2 (outdoor temperature $<4^{\circ}\text{C}$) |

[9] Automatic temperature compensation

If necessary, it is possible to adjust some thermistor value of the unit by a correction value. This can be used as countermeasure for thermistor tolerances or capacity shortage.

6 Configuration

The compensated temperature (= measured temperature plus compensation value) is then used to control the system and will be displayed in the temperature read-out mode.

[9-00] Leaving water temperature compensation value for heating operation

[9-01] Leaving water thermistor auto corrective function

This function will take into account the outdoor ambient conditions and correct the measured value which will be used for the logic.

E.g. when the ambient temperature is high during cooling mode, the logic will correct the measured value of the leaving water thermistor to a lower value to take into account influence of high ambient temperatures in the measurement.

[9-02]

This setting is not applicable.

[9-03] Leaving water temperature compensation value for cooling operation

[9-04]

This setting is not applicable.

[A] Option setup

[A-00]

This setting is not applicable.

[A-01]

This setting is not applicable.

[A-02] Return water temperature undershoot value

This setting makes it possible to set the allowable undershoot when operating the unit during heating THERMO ON/OFF condition.

The unit will go in THERMO ON only if the return water temperature (RWT) goes below the setpoint minus the differential temperature:

Thermo ON: $RWT < \text{Setpoint} - (([A-02]/2) + 1)$

The setting [A-02] has a variability range from 0 to 15 and the step is 1 degree. The default value is 5, meaning that the differential temperature default value is 3.5.

[A-03] Leaving water temperature overshoot/undershoot value

This setting makes it possible to set the allowable overshoot (heating)/undershoot (cooling) when operating the unit during leaving water control.

[A-04] Glycol concentration setting

This setting is only applicable for units with a low temperature cooling option.

When changing this setting, the freeze prevention parameters will be changed in relation with the glycol concentration.

| [A-04] | Description |
|--------|---|
| 0 | 30% glycol, minimum leaving water=0°C |
| 1 | 40% glycol, minimum leaving water=-10°C |



CAUTION

Glycol concentrations lower than the set parameter will cause the fluid to freeze.

[b] Settings are not applicable

[C] Leaving water temperature limits

This setting is used to limit the selectable leaving water temperature on the remote controller.

[C-00] Maximum leaving water setpoint in heating operation

[C-01] Minimum leaving water setpoint in heating operation

[C-02] Maximum leaving water setpoint in cooling operation

[C-03] Minimum leaving water setpoint in cooling operation

This depends on field setting [A-04].

[C-04]

This setting is not applicable.

[d] Settings are not applicable

[E] Service mode

[E-00]

This setting is not applicable.

[E-01]

This setting is not applicable.

[E-02]

This setting is not applicable.

[E-03]

This setting is not applicable.

[E-04] Pump only operation (air purge function)

When installing and commissioning the unit it is very important to remove all air from the water circuit.

This field setting operates the pump to improve air removal from the unit without actually operating the unit. The pump will run for 10 minutes, stop 2 minutes, etc.

| [E-04] | Description |
|-------------|--|
| 0 (default) | Normal operation of the unit |
| 1 | Automatic air purge operation during 108 minutes |
| 2 | Automatic air purge operation during 48 minutes |

[F] Option setup

[F-00] Return water temperature overshoot value

This setting makes it possible to set the allowable overshoot when operating the unit during cooling THERMO ON/OFF condition.

The unit will go in THERMO ON only if the return water temperature (RWT) goes above the setpoint plus the differential temperature:

Thermo ON: $RWT < \text{Setpoint} + (([F-00]/2) + 1)$

The setting [F-00] has a variability range from 0 to 15 and the step is 1 degree. The default value is 5, meaning that the differential temperature default value is 3.5.

6.3 Switching between cooling and heating

Switching the unit between cooling and heating can be done in 2 different ways. This will depend on how the temperature is controlled, i.e. based on room temperature or based on leaving water temperature.

If the unit control is based on room temperature (external room thermostat or remote controller room thermostat), switching between cooling and heating is done through the remote controller by pushing the cooling/heating button.

If the unit control is based on leaving water temperature, we suggest using the ABC terminals on the outdoor unit (heat pump units only). The location of the terminals is shown in the following figure.

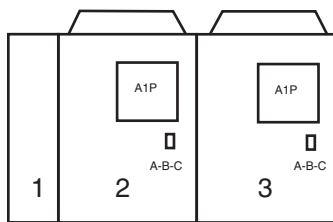

- 1 Hydrobox
- 2 Master unit (left unit)
- 3 Slave unit (right unit) if multi-system

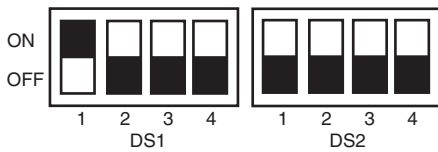

- 1 Set DS1 on the outdoor master unit A1P PCB to the ON position.
- 2 Press BS5 for 5 seconds to re-initialise communication of the module.
 - Cooling: voltage free contact between terminals A and C is open
 - Heating: voltage free contact between terminals A and C is closed

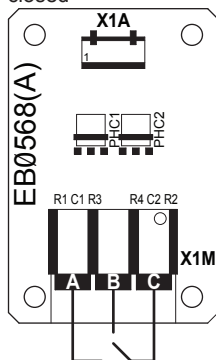

INFORMATION

Thermostat input has priority over leaving water temperature setpoint.

It is possible that the leaving water temperature becomes lower than the setpoint if the unit is controlled by room temperature.

7 Commissioning

After installation and once the field settings are defined, the installer is obliged to verify correct operation. Therefore a test run must be performed according to the procedures described below.

7.1 Precautions when commissioning



CAUTION

Do not perform the test operation while working on the indoor units.

When performing the test operation, not only the outdoor unit, but the connected indoor unit will operate as well. Working on an indoor unit while performing a test operation is dangerous.



NOTICE

Be sure to turn on the power 6 hours before operation in order to have power running to the crankcase heater and to protect the compressor.

During test operation, the outdoor unit and the indoor units will start up. Make sure that the preparations of all indoor units are finished (field piping, electrical wiring, air purge, ...). See installation manual of the indoor units for details.

7.2 Checklist before commissioning

After the installation of the unit, first check the following items. Once all below checks are fulfilled, the unit must be closed, only then can the unit be powered up.

| | |
|--------------------------|---|
| <input type="checkbox"/> | You read the complete installation and operation instructions, as described in the installer and user reference guide. |
| <input type="checkbox"/> | Installation Check that the unit is properly installed, to avoid abnormal noises and vibrations when starting up the unit. |
| <input type="checkbox"/> | Field wiring Be sure that the field wiring has been carried out according to the instructions described in the chapter "5.4 Connecting the electrical wiring" on page 11, according to the wiring diagrams and according to the applicable legislation. |
| <input type="checkbox"/> | Power supply voltage Check the power supply voltage on the local supply panel. The voltage must correspond to the voltage on the identification label of the unit. |
| <input type="checkbox"/> | Earth wiring Be sure that the earth wires have been connected properly and that the earth terminals are tightened. |
| <input type="checkbox"/> | Insulation test of the main power circuit Using a megatester for 500 V, check that the insulation resistance of 2 MΩ or more is attained by applying a voltage of 500 V DC between power terminals and earth. Never use the megatester for the transmission wiring. |
| <input type="checkbox"/> | Fuses, circuit breakers, or protection devices Check that the fuses, circuit breakers, or the locally installed protection devices are of the size and type specified in the chapter "4.3.1 Safety device requirements" on page 8. Be sure that neither a fuse nor a protection device has been bypassed. |
| <input type="checkbox"/> | Internal wiring Visually check the electrical component box and the inside of the unit on loose connections or damaged electrical components. |
| <input type="checkbox"/> | Pipe size and pipe insulation Be sure that correct pipe sizes are installed and that the insulation work is properly executed. |
| <input type="checkbox"/> | The air purge valve is open (at least 2 turns). |
| <input type="checkbox"/> | Shut-off valves Be sure that the shut-off valves are correctly installed and fully open. |
| <input type="checkbox"/> | Filter Make sure that the filter is installed correctly. |
| <input type="checkbox"/> | Damaged equipment Check the inside of the unit on damaged components or squeezed pipes. |
| <input type="checkbox"/> | Water leak Check the inside of the unit for water leakage. If there is a water leak, try to repair the leak. If the repair is unsuccessful, close the water inlet and outlet shut-off valves and call your local dealer. |

8 Troubleshooting

| | |
|--------------------------|--|
| <input type="checkbox"/> | Installation date and field setting Be sure to keep record of the installation date on the sticker on the rear of the upper front panel according to EN60335-2-40 and keep record of the contents of the field setting(s). |
| <input type="checkbox"/> | Schedule timer form Fill out the form at the very end of this document. When programming the schedule timer, this form can help you define the required actions for each day. |



NOTICE

Operating the system with closed valves will damage the pump.

Once all checks are fulfilled, the unit must be closed, only then can the unit be powered up. When the power supply to the unit is turned on, "88" is displayed on the remote controller during its initialization, which may take up to 30 seconds. During this process, the remote controller cannot be operated.

8 Troubleshooting

8.1 Error codes: Overview

| Main code | Cause | Solution |
|-----------|--|--|
| R1 | Failure writing memory (EEPROM error) | Contact your local dealer. |
| R5 | Water circuit malfunction | <ul style="list-style-type: none"> Check that water flow is possible (open all valves in the circuit). Force clean water through the unit. |
| R9 | R410A expansion valve error (K11E/K12E) | <ul style="list-style-type: none"> Check wiring connections. Contact your local dealer. |
| RE | Water system warning | <ul style="list-style-type: none"> Check filter. Make sure all valves are open. Contact your local dealer. |
| RJ | Capacity error | Contact your local dealer. |
| C1 | Bad ACS communication | Contact your local dealer. |
| C4 | R410A liquid thermistor error (R13T/R23T) | <ul style="list-style-type: none"> Check wiring connections. Contact your local dealer. |
| C9 | Returning water thermistor error (R12T/R22T) | <ul style="list-style-type: none"> Check wiring connections. Contact your local dealer. |
| CR | Heating leaving water thermistor error (R11T/R12T) | <ul style="list-style-type: none"> Check wiring connections. Contact your local dealer. |
| CJ | Remote controller thermostat thermistor error | Contact your local dealer. |
| E3 | High pressure error (SENP/S1PH) | <ul style="list-style-type: none"> Check that the circuit does not contain any air. Check that water flow is possible (open all valves in the circuit). Check that the water filter is not blocked. Check that all refrigerant stop valves are open. Contact your local dealer. |
| E4 | Low pressure error (SENPL) | Contact your local dealer. |
| J7 | R410A suction thermistor error (R14T/R24T) | <ul style="list-style-type: none"> Check wiring connections. Contact your local dealer. |
| U1 | Reversed power supply phase malfunction | Correct phase order. |
| U2 | Insufficient supply voltage | <ul style="list-style-type: none"> Check wiring connections. Contact your local dealer. |

7.3 Final check

Before switching on the unit, read the following recommendations:

- When the complete installation and all necessary settings have been carried out, be sure that all panels of the unit are closed. If this is not the case, inserting your hand through the remaining openings can cause serious injury due to electrical and hot parts inside the unit.
- The service panel of the electrical component box may only be opened by a licensed electrician for maintenance purposes.



DANGER: RISK OF ELECTROCUTION

Do NOT leave the unit unattended when the service cover is removed.



INFORMATION

During the first running period of the unit, the required power may be higher than stated on the nameplate of the unit. This phenomenon is caused by the compressor, that needs a continuous run time of 48 hours before reaching smooth operation and stable power consumption.

| Main code | Cause | Solution |
|-----------|---|---|
| UB | Two main remote controllers are connected (when using two remote controllers) | Check that SS1 of one controller is set to MAIN, and the other one to SUB. Turn the power supply off, and then back on. |
| UR | Type connection problem | <ul style="list-style-type: none"> Wait until initialization between the outdoor module and the hydro module is completed (wait at least 12 minutes after power ON). Contact your local dealer. |
| UH | Address error | Contact your local dealer. |

9 Technical data

A **subset** of the latest technical data is available on the regional Daikin website (publicly accessible). The **full set** of latest technical data is available on the Daikin extranet (authentication required).

9.1 Service space: Outdoor unit

Make sure the space around the unit is adequate for servicing and the minimum space for air inlet and air outlet is available (refer to the figure below and choose one of the possibilities).

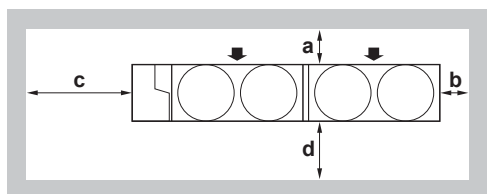

| A+B+C+D | |
|---------------|---------------|
| Possibility 1 | Possibility 2 |
| a ≥ 300 mm | a ≥ 500 mm |
| b ≥ 100 mm | b ≥ 500 mm |
| c ≥ 500 mm | c ≥ 500 mm |
| d ≥ 500 mm | d ≥ 500 mm |

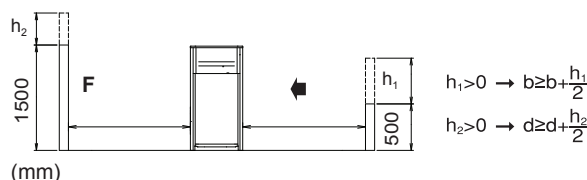

- ABCD Sides along the installation site with obstacles
- F Front side
- ➔ Suction side

- If the location of the installation is in a cold climate, then dimensions **a** and **b** above should be >500 mm to avoid accumulation of ice in between the outdoor units.



INFORMATION

Further specifications can be found in the technical engineering data.

9.2 Piping diagram: Outdoor module

Piping diagram: Outdoor module

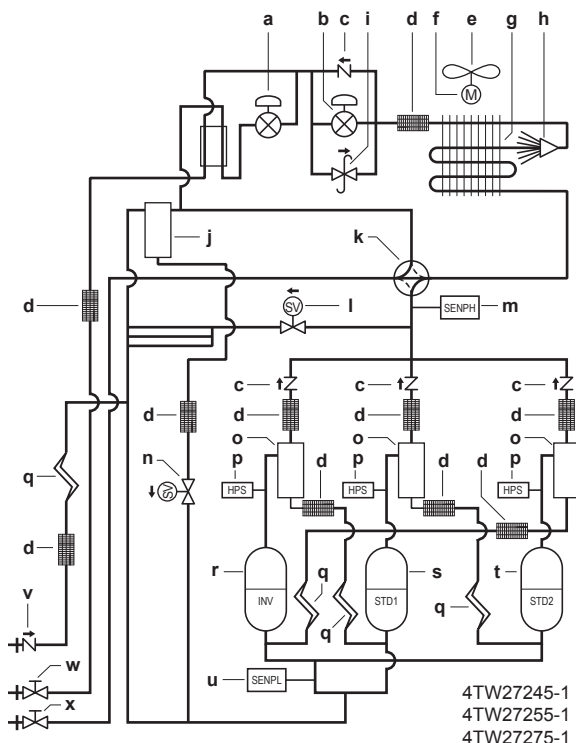

- a Electronic expansion valve, subcooling (Y2E)
- b Electronic expansion valve, main (Y1E)
- c Check valve
- d Filter
- e Fan
- f Fan motor (M1F, M2F)
- g Heat exchanger
- h Distributor
- i Pressure regulating valve
- j Accumulator
- k 4-way valve, heat exchanger (Y3S)
- l Solenoid valve, main (Y1S)
- m High pressure sensor (SENPH)
- n Solenoid valve (Y2S)
- o Oil separator
- p High pressure switch
- q Capillary tube
- r Compressor (INV)
- s Compressor (STD1)
- t Compressor (STD2)
- u Low pressure sensor (SENPL)
- v Service port, refrigerant charge
- w Stop valve, liquid pipe
- x Stop valve, gas pipe

4TW27245-1
4TW27255-1
4TW27275-1

9 Technical data

Piping diagram: Hydro module

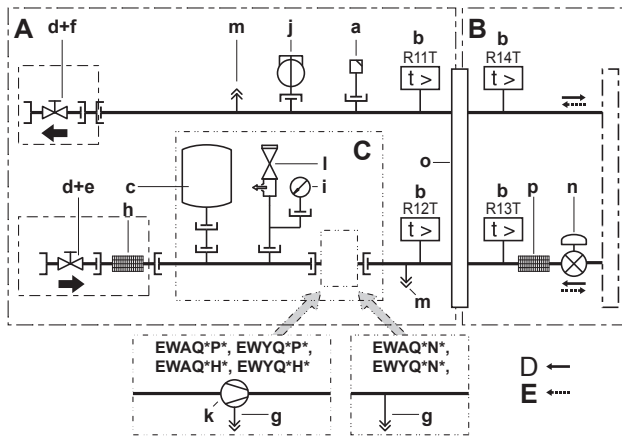

- a Air purge valve
- b Temperature sensors (R11T, R12T, R13T, R14T)
- c Expansion vessel (12 l)
- d Shut-off valve (field installed)
- e Water inlet connection
- f Water outlet connection
- g Drain port
- h Water filter
- i Pressure gauge
- j Flow switch
- k Pump
- l Safety valve
- m Check valve
- n Electronic expansion valve
- o Heat exchanger
- p Filter
- A Water side
- B Refrigerant side
- C Only for models with a pump
- D Refrigerant flow in cooling mode
- E Refrigerant flow in heating mode

9.3 Wiring diagram: Outdoor unit

Refer to the wiring diagram sticker on the outdoor module. The abbreviations used are listed below:



INFORMATION

The wiring diagram on the outdoor module is only for the outdoor module. For the hydro module or optional electrical components, refer to the wiring diagram of the hydro module.

| | |
|--------------|--|
| A1P~A8P | Printed circuit board (main, sub 1, sub 2, noise filter, inverter, fan, current sensor) |
| BS1~BS5 | Pushbutton switch (mode, set, return, test, reset) |
| C1, C63, C66 | Capacitor |
| E1HC, E2HC | Crankcase heater |
| F1U | Fuse (DC 650 V, 8 A) |
| F1U | Fuse (250 V, 3.15 A, T) |
| F1U,F2U | Fuse (250 V, 3.15 A, T) |
| F5U | Field fuse |
| F400U | Fuse (250 V, 6.3 A, T) |
| H1P~H8P | Pilot lamp |
| H2P | Under preparation or in test operation when blinking |
| H2P | Malfunction detection when light up |
| HAP | Pilot lamp (service monitor - green) |
| K1, K3 | Magnetic relay |
| K1R | Magnetic relay (K2M, Y4S) |
| K2, K4 | Magnetic contactor (M1C) |
| K2R | Magnetic relay (Y5S) |
| K3R | Magnetic relay (Y1S) |
| K4R | Magnetic relay (Y8S) |
| K5R | Magnetic relay (Y2S) |
| K5R | Magnetic relay (for option) |
| K6R | Magnetic relay (Y8S) |
| K7R, K8R | Magnetic relay (E1HC, E2HC) |
| K11R | Magnetic relay (Y3S) |
| L1R | Reactor |
| M1C, M2C | Motor (compressor) |
| M1F, M2F | Motor (fan) |
| PS | Switching power supply |
| Q1DI | Earth leakage protector (field supply) |
| Q1RP | Phase reversal detection circuit |
| R10 | Resistor |
| R50, R59 | Resistor |
| R90 | Resistor (current sensor) |
| R95 | Resistor (current limiting) |
| R1T | Thermistor (air, fin) |
| R2T~R15T | Thermistor (H/E gas 1, H/E de-icer 1, sub cool H/E gas 1, sub cool H/E liquid, H/E liquid 1, suction 1, liquid 1, suction 2, H/E gas 2, H/E de-icer 2, sub cool H/E gas 2, liquid 2, H/E liquid 2) |
| R31T, R32T | Thermistor (discharge) (M1C, M2C) |
| S1NPH | Pressure sensor (high) |
| S1NPL | Pressure sensor (low) |
| S1PH~S3PH | Pressure switch (high) |

| | |
|----------|--|
| SD1 | Safety devices input |
| T1A | Current sensor |
| V1R | Diode bridge |
| V1R, V1R | Power module |
| X1A~X9A | Connector |
| X1M | Terminal strip (power supply) |
| X1M | Terminal strip (control) |
| Y1E~Y5E | Electronic expansion valve (main 1, sub cool 1, main 2, charge, sub cool 2) |
| Y1S~Y10S | Solenoid valve (RMTG, 4 way valve-H/E gas 1, RMTL, hot gas, EV bypass 1, RMTT, RMTO, 4 way valve-H/E gas 2, EV bypass 2) |
| Z1C~Z10C | Noise filter (ferrite core) |
| Z1F | Noise filter (with surge absorber) |
| L1,L2,L3 | Live |
| N | Neutral |
| ⏏ | Field wiring |
| □□□□ | Terminal strip |
| ⊞ | Connector |
| ○ | Terminal |
| ⏏ | Protective earth (screw) |
| BLK | Black |
| BLU | Blue |
| BRN | Brown |
| GRN | Green |
| GRY | Grey |
| ORG | Orange |
| PNK | Pink |
| RED | Red |
| WHT | White |
| YLW | Yellow |

Hydro module

| | |
|-----------|--|
| A1P | Main printed circuit board (master) |
| A2P | Remote controller printed circuit board |
| A3P | Control printed circuit board |
| A4P | Demand printed circuit board (optional) |
| A5P | Main printed circuit board (slave) |
| A6P | Demand printed circuit board (optional) |
| A7P | Remote controller printed circuit board (optional) |
| C1~C3 | Filter capacitor |
| E1H | Electrical component box heater |
| E2H | Plate heat exchanger heater (PHE1) |
| E3H | Plate heat exchanger heater (PHE2) |
| E4H | Water piping heater |
| E5H | Expansion vessel heater |
| F1, F2 | Fuse (250 V, 5 A, F) |
| F1U (A*P) | Fuse (250 V, 3.15 A, T) |
| HAP | Printed circuit board LED |
| K11E | Electronic expansion valve (PHE1) |
| K21E | Electronic expansion valve (PHE2) |

10 About the system

| | | | |
|-----------|--|----------------|---|
| K1P | Pump contactor | S1F | Flow switch (PHE1) |
| K1S | Pump overcurrent relay | S2F | Flow switch (PHE2) |
| K*R (A3P) | Printed circuit board relay | S1M | Main switch |
| M1P | Pump | S1S | Thermostat ON/OFF input (field supply) |
| PS (A*P) | Switching power supply | S2S | Thermostat cooling/heating selection (field supply) |
| Q1DI | Earth leakage circuit breaker (field supply) | S3S | Operation ON input (field supply) |
| Q1T | Thermostat for expansion vessel heater | S4S | Operation OFF input (field supply) |
| R11T | Leaving water thermistor (PHE1) | SS1 (A1P, A5P) | Selector switch (emergency) |
| R12T | Returning water thermistor (PHE1) | SS1 (A2P) | Selector switch (master/slave) |
| R13T | Refrigerant liquid thermistor (PHE1) | SS1 (A7P) | Selector switch (master/slave) (optional) |
| R14T | Refrigerant gas thermistor (PHE1) | V1C, V2C | Ferrite core noise filter |
| R21T | Leaving water thermistor (PHE2) | X1M~X4M | Terminal strip |
| R22T | Returning water thermistor (PHE2) | X801M (A*P) | Printed circuit board terminal strip (control) |
| R23T | Refrigerant liquid thermistor (PHE2) | Z1F, Z2F (A*P) | Noise filter |
| R24T | Refrigerant gas thermistor (PHE2) | | |

For the user

10 About the system

NOTICE

For future modifications or expansions of your system:

A full overview of allowable combinations (for future system extensions) is available in technical engineering data and should be consulted. Contact your installer to receive more information and professional advice.

This small inverter chiller can be combined with fan coil units for air conditioning purposes, or it can be used for supplying water for process cooling applications.

10.1 System layout

Your small inverter chiller can be one of following models:

| Model | Description |
|-------|----------------------------------|
| EWAQ | Air-to-water cooling only model. |
| EWYQ | Air-to-water heat pump model. |

11 User interface

CAUTION

NEVER touch the internal parts of the controller.

Do NOT remove the front panel. Some parts inside are dangerous to touch and appliance problems may happen. For checking and adjusting the internal parts, contact your dealer.

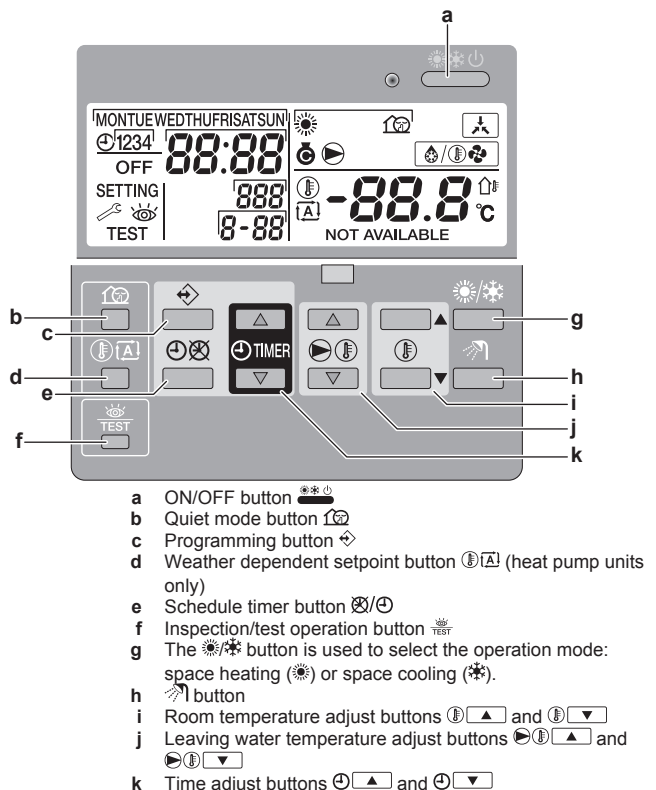

| Icon | Description |
|------|--|
| | Operation LED Lit during space heating operation. Blinks if a malfunction occurs. When the LED is off, space heating is inactive while the other operation modes can still be active. |
| | Heating mode |
| | Cooling mode |
| | Quiet mode |

| Icon | Description |
|-----------------------------|---|
| | External control The unit is working in a forced operation. As long as this icon is displayed, the remote controller cannot be operated. |
| | The compressor in the unit of the installation is active. |
| | The circulation pump is active. |
| | Defrost/start up mode (heat pump units only) |
| | Flashes to display the outdoor ambient temperature. |
| | Weather dependent setpoint (heat pump units only) The controller will adapt the leaving water temperature setpoint automatically, based on the outdoor ambient temperature. |
| | The actual room temperature or room temperature setpoint are shown. Also displayed when the temperature setpoint is set in schedule timer programming mode. See " 12.3.5 Other operation modes " on page 30 for more information. |
| -88.8° | Current temperature of the installation, either leaving water temperature or actual room temperature. When changing the room temperature setpoint, the setpoint will flash for 5 seconds and then return to the actual room temperature. |
| NOT AVAILABLE | A non-installed option is addressed or a function is not available. An unavailable function can mean insufficient permission level or can mean that a slave remote controller is used (see " 6.2.9 Field settings on the remote controller " on page 16). |
| MON TUE WED THU FRI SAT SUN | Current day of the week. When reading or programming the schedule timer, the indicator shows the set day. |
| 88:88 | Current time. When reading or programming the schedule timer, the clock display shows the action time. |
| | The schedule timer is enabled. |

| Icon | Description |
|----------------|---|
| 1234 | Programming actions for each day of the schedule timer. |
| OFF | The OFF action is selected when programming the schedule timer. |
| SETTING | Field setting mode |
| | Inspection required. Consult your dealer. |
| | Inspection required. Consult your dealer. |
| TEST | Test mode. |
| 888 | This is an error code; for service purposes only. Refer to the error code list in " 8.1 Error codes: Overview " on page 22. |
| 8-88 | Code from the field settings list. Refer to " 6.2.9 Field settings on the remote controller " on page 16. |

12 Operation

12.1 Operation range

Use the system in the following temperature ranges for safe and effective operation.

| | Cooling | Heating |
|---------------------|-------------|-------------|
| Outdoor temperature | -15~43°C DB | -15~35°C DB |

12.2 Quick start-up

The flow chart shows the steps required for starting up space cooling/heating and allows the user to start up the system before reading the entire manual.

See "[12.3 Operating the system](#)" on page 28 for more detailed information.

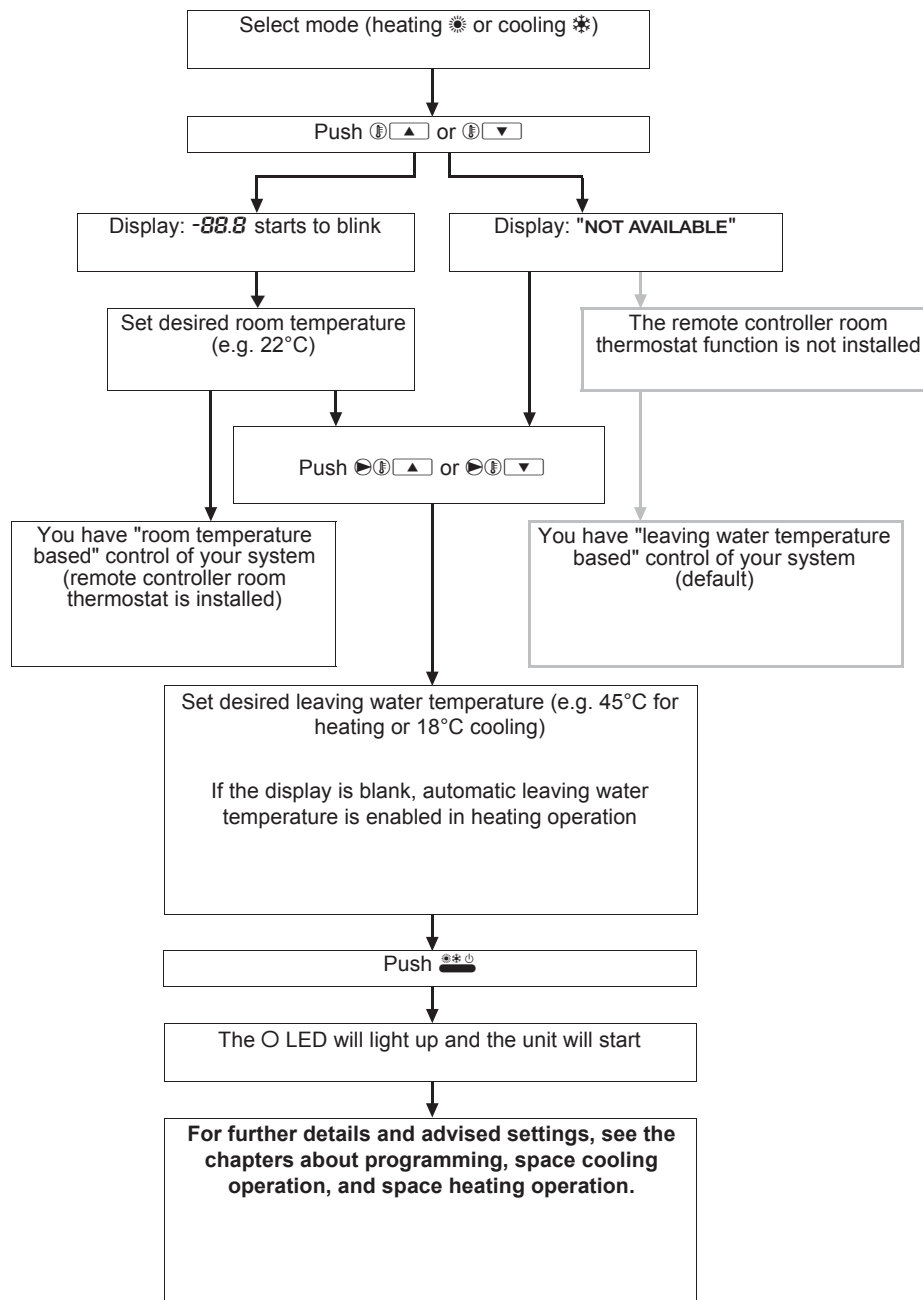

12.3 Operating the system

12.3.1 About the clock



INFORMATION

- The clock must be set manually. Adjust the setting when switching from summertime to wintertime and vice versa.
- The clock cannot be adjusted if the controller is set to permission level 2 or 3 (see field setting [0-00] in "6.2.9 Field settings on the remote controller" on page 16).
- A power failure of more than 2 hours will reset the clock and the day of the week. The schedule timer will continue operation, but with a disordered clock. Correct the clock and the day of the week.

To set the clock

- 1 Hold down the ⏸/⏸ button for 5 seconds.
Result: The clock read-out and the day of week indicator start flashing.
- 2 Press the ⏸▲ or ⏸▼ button to increase/decrease the time by 1 minute. Keep the button pressed to increase/decrease the time by 10 minutes.
- 3 Press the ⏸▲ or ⏸▼ button to display the previous or next day of the week.
- 4 Press the ⏸ button to confirm the current set time and day of the week.
- 5 Press the ⏸/⏸ button to cancel this procedure without saving.
Result: If no button is pressed for 5 minutes, the clock and day of the week will return to their previous setting.

12.3.2 About operating the system

If the main power supply is turned off during operation, operation will restart automatically after the power turns back on again.

12.3.3 Space cooling operation

Space cooling can be controlled in 2 different ways:

- based on room temperature
- based on leaving water temperature (default)

To switch space cooling on/off using room temperature control



In this mode, cooling will be activated as required by the room temperature setpoint. The setpoint can be set manually or through the schedule timer.

INFORMATION

- When using room temperature control, space cooling operation based on room temperature will have priority over leaving water control.
- It is possible that the leaving water temperature becomes higher than the setpoint if the unit is controlled by room temperature.



- 1 Press  to switch space cooling (❄️) on/off.

Result: ❄️ and the corresponding actual room temperature setpoint appear on the display. The operation LED  lights up.

- 2 Set the desired room temperature using  and . For setup of the schedule timer function, see ["12.3.6 Schedule timer" on page 30](#).

INFORMATION

Temperature range for cooling: 16°C~32°C (room temperature)



- 3 Select the leaving water temperature which you want to be used to cool down your system using  and . For detailed information, see ["To switch space cooling on/off using leaving water temperature control" on page 29](#).

To switch space cooling on/off using leaving water temperature control

In this mode, cooling will be activated as required by the water temperature setpoint. The setpoint can be set manually or through the schedule timer.

- 1 Press  to switch space cooling (❄️) on/off.

Result: ❄️ and the corresponding actual room temperature setpoint appear on the display. The operation LED  lights up.

- 2 Set the desired leaving water temperature using  and . In case the unit has the low temperature cooling option, lower leaving water temperatures (<5°C) are possible, depending on the glycol concentration setting. For more information, see field setting [9] in ["6.2.9 Field settings on the remote controller" on page 16](#).

INFORMATION

Temperature range for cooling: 5°C~20°C (leaving water temperature) (-10°C~20°C when glycol is used).

For setup of the schedule timer function, see ["To program space cooling" on page 32](#), ["To program space heating" on page 33](#), and ["To program quiet mode" on page 33](#).

INFORMATION

- When an external room thermostat is installed, the thermo ON/OFF is determined by the external room thermostat. The remote controller is then operated in the leaving water control mode and is not functioning as a room thermostat.
- The remote controller ON/OFF status always has priority over the external room thermostat!

INFORMATION

Setback operation and weather dependent setpoint are not available in the cooling mode.

12.3.4 Space heating operation

Space heating is available for heat pump units only.

Space heating can be controlled in 2 different ways:

- based on room temperature
- based on leaving water temperature (default)

To switch space heating on/off using room temperature control

Room temperature control



In this mode, heating will be activated as required by the room temperature setpoint. The setpoint can be set manually or through the schedule timer.

INFORMATION

- When using room temperature control, space heating operation based on room temperature will have priority over leaving water control.
- It is possible that the leaving water temperature becomes higher than the setpoint if the unit is controlled by room temperature.



- 1 Press  to switch space heating (🔥) on/off.

Result: 🔥 and the corresponding actual room temperature setpoint appear on the display. The operation LED  lights up.

- 2 Set the desired room temperature using  and . In order to avoid overheating, space heating cannot be used when the outdoor ambient temperature rises above a certain temperature (see ["12.1 Operation range" on page 27](#)). For setup of the schedule timer function, see ["12.3.6 Schedule timer" on page 30](#).

INFORMATION

Temperature range for heating: 16°C~32°C (room temperature)

- 3 Select the leaving water temperature which you want to be used to heat up your system using  and . For detailed information, see ["To switch space heating on/off using leaving water temperature control" on page 30](#).

Automatic setback function

For the automatic setback function settings, see field setting [2] in ["6.2.9 Field settings on the remote controller" on page 16](#).

12 Operation







INFORMATION

-  flashes during setback operation.
- While room temperature setback function is active, leaving water setback operation is also performed (see "To switch space cooling on/off using leaving water temperature control" on page 29).
- Do not to set the setback value too low, especially during colder periods (e.g. winter time). It is possible that the room temperature cannot be reached (or it will take much longer) because of the big temperature difference.

The setback function provides the possibility to lower the room temperature. It can be activated e.g. during the night, because temperature demands during night and day are not the same.

To switch space heating on/off using leaving water temperature control

In this mode, heating will be activated as required by the water temperature setpoint. The setpoint can be set manually or through the schedule timer.

- 1 Press  to switch space heating () on/off.
Result:  and the corresponding actual room temperature setpoint appear on the display. The operation LED  lights up.
- 2 Set the desired leaving water temperature using  and . In order to avoid overheating, space heating cannot be used when the outdoor ambient temperature rises above a certain temperature (see "12.1 Operation range" on page 27).

INFORMATION

Temperature range for heating: 25°C~50°C (leaving water temperature)





For setup of the schedule timer function, see "12.3.6 Schedule timer" on page 30.

INFORMATION

- When an external room thermostat is installed, the thermo ON/OFF is determined by the external room thermostat. The remote controller is then operated in the leaving water control mode and is not functioning as a room thermostat.
- The remote controller ON/OFF status always has priority over the external room thermostat!



Weather dependent setpoint operation

For the automatic setback function settings, see field setting [2] in "6.2.9 Field settings on the remote controller" on page 16.

- 3 Press  1 time to select weather dependent setpoint operation (or 2 times when the remote controller room thermostat function is used).
Result:  appears on the display as well as the shift value. The shift value is not shown if it is 0.
- 4 Set the shift value using  and .
Result:  will be displayed as long as the weather dependent setpoint operation is enabled.

INFORMATION

Range for shift value: -5°C~+5°C

- 5 Press  to deactivate weather dependent setpoint operation.
- 6 Set the leaving water temperature using  and .

INFORMATION

During this operation, instead of showing the water temperature setpoint, the controller shows the shift value which can be set by the user.

Automatic setback function

For the automatic setback function settings, see field setting [2] in "6.2.9 Field settings on the remote controller" on page 16.

12.3.5 Other operation modes

Start up operation

During start up,  on the display means that the heat pump is still starting up.

Defrost operation ()

INFORMATION





This function is available for heat pump units ONLY.

In space heating operation, freezing of the outdoor heat exchanger may occur due to low outdoor temperature. If this risk occurs, the system goes into defrost operation. It reverses the cycle and takes heat from the water system to prevent freezing of the outdoor system. After a maximum of 15 minutes of defrost operation, the system returns to space heating operation. Space heating operation is not possible during defrost operation.















Quiet mode operation ()

Quiet mode operation means that the unit works at reduced compressor speed so that the noise produced by the unit drops. This implies that it will take longer until the required temperature setpoint is reached. Beware of this when a certain level of heating is required indoors.

There are 3 different levels of quiet mode operation. The desired quiet mode is set through a field setting.

- 1 Press  to activate quiet mode operation.
Result:  appears on the display. If the controller is set to permission level 2 or 3 (see "6.2 Making field settings" on page 13), the  button cannot be used.
- 2 Press  again to deactivate quiet mode operation.
Result:  disappears from the display.

The actual temperatures can be displayed on the remote controller.

- 3 Press  for 5 seconds.
Result: The leaving water temperature is displayed (, , and  blink).
- 4 Press  and  to display:
 - The entering water temperature (,  blink, and  flashes slowly).
 - The indoor temperature (,  blink).
 - The outdoor temperature (,  blink).
- 5 Press  again to leave this mode. If no button is pressed, the remote controller leaves the display mode after 10 seconds.

12.3.6 Schedule timer

Press  to enable or disable the schedule timer (.

Four actions per day can be programmed, making a total of 28 actions per week.

The schedule timer can be programmed in 2 different ways:

- based on the temperature setpoint (leaving water temperature and room temperature)
- based on the ON/OFF instruction.

The programming method is set in the field settings. See "6.2 Making field settings" on page 13. Before programming, fill out the form at the very end of this document. This form can help you define the required actions for each day.

i INFORMATION

- When power is restored after a power failure, the auto restart function reapplies the remote controller settings at the time of the power failure (if the power was interrupted for less than 2 hours). It is therefore recommended to leave the auto restart function enabled.
- As the programmed schedule is time driven, it is essential to set the clock and the day of the week correctly. See "12.3.1 About the clock" on page 28.
- Schedule timer actions will only be executed when the schedule timer is enabled (⊕ visible on the display)!
- The programmed actions are not stored according to their time of execution, but according to the time of programming, i.e. action number 1 is the action that was programmed first, even though it may be executed after other programmed action numbers.
- If 2 or more actions are programmed for the same day and at the same time, only the action with the lowest action number will be executed.

Space heating

[0-03] Status

Defines whether the ON/OFF instruction can be used in the schedule timer for space heating.

| Space heating based on ON/OFF instruction | |
|---|---|
| During operation | When the schedule timer switches space heating OFF, the controller will be switched off (operation LED will stop working). |
| Press **⏻ | <p>The schedule timer for space heating will stop (when active at that moment) and will start again at the next scheduled ON function.</p> <p>The "last" programmed command overrules the "preceding" programmed command and will remain active until the "next" programmed command occurs.</p> <p>Example: imagine the actual time is 17:30 and actions are programmed at 13:00, 16:00 and 19:00. The "last" programmed command (16:00) overruled the "previous" programmed command (13:00) and will remain active until the "next" programmed command (19:00) occurs.</p> <p>So in order to know the actual setting, you should consult the last programmed command (this may date from the day before).</p> <p>The controller is switched off (operation LED off), but the schedule timer icon remains on.</p> |
| Press ⊗/⊕ | <p>The schedule timer for space heating and the quiet mode stops and will not start again.</p> <p>The schedule timer icon is not displayed any more.</p> |

- Operation example: Schedule timer based on ON/OFF instruction. When the setback function (see field setting [2]) is enabled, the setback operation will have priority over the scheduled action in the schedule timer if ON instruction is active. If OFF instruction is active this will have priority over the setback function. At any time the OFF instruction will have the highest priority.

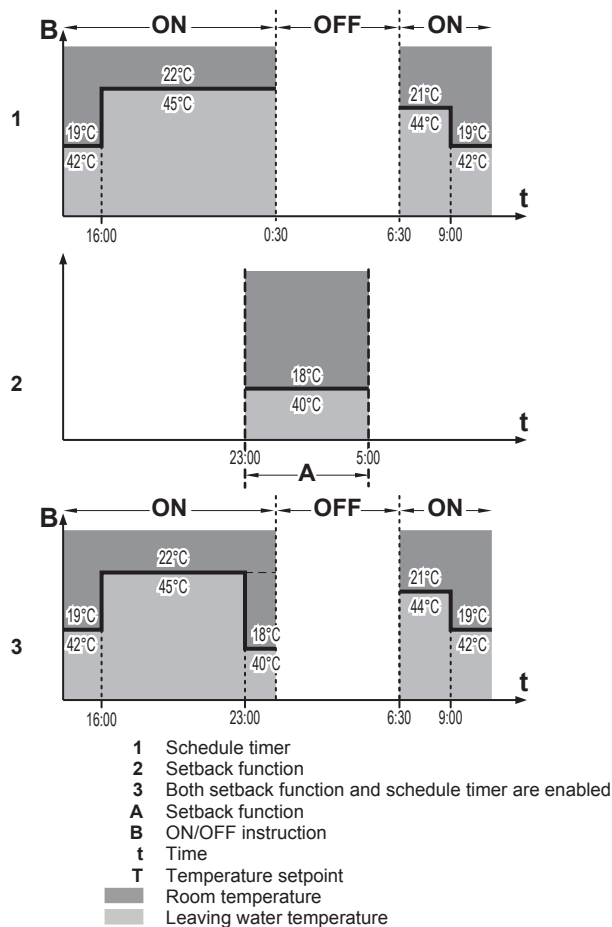

| Space heating based on temperature setpoint ^(a) | |
|--|--|
| During operation | During schedule timer operation the operation LED is lit continuously. |
| Press **⏻ | <p>The schedule timer for space heating stops and will not start again.</p> <p>The controller is switched off (operation LED off).</p> |
| Press ⊗/⊕ | <p>The schedule timer for space heating and the quiet mode stops and will not start again.</p> <p>The schedule timer icon is not displayed any more.</p> |

(a) For leaving water temperature and/or room temperature

- Operation example: Schedule timer based on temperature setpoint

When the setback function (see field setting [2]) is enabled, the setback operation will have priority over the scheduled action in the schedule timer.

12 Operation

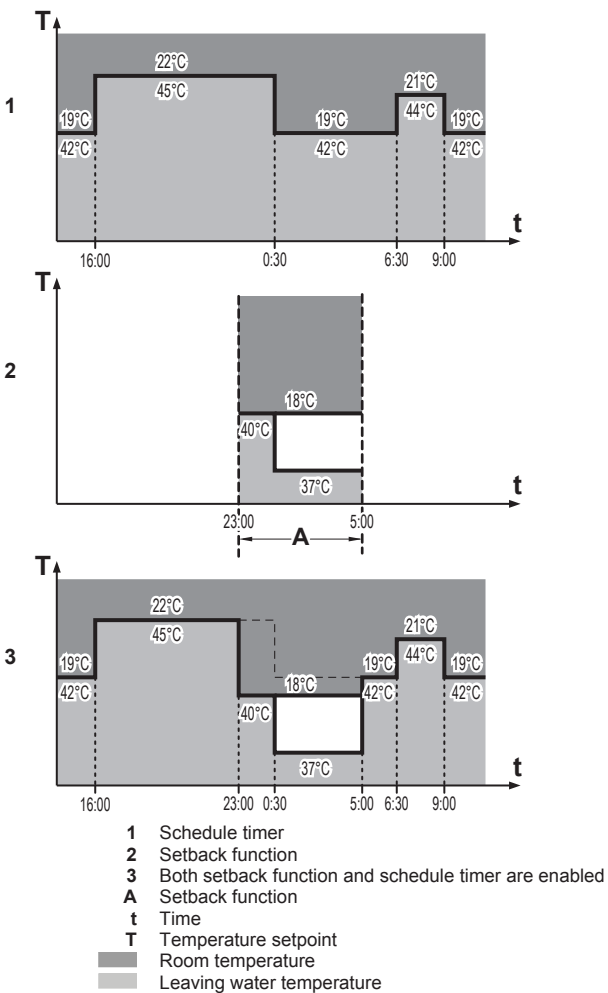

i INFORMATION

Space heating based on temperature setpoint is enabled by default, so only temperature shifts are possible (no ON/OFF instruction).

Space cooling

[0-04] Status

Defines whether the ON/OFF instruction can be used in the schedule timer for cooling.

This is the same as for space heating [0-03], but the setback function is not available.

i INFORMATION

Space cooling based on temperature setpoint is enabled by default, so only temperature shifts are possible (no ON/OFF instruction).

Quiet mode

See "To program quiet mode" on page 33.

Switch the mode on or off at a scheduled time. Four actions can be programmed per day. These actions are repeated daily.

To program space cooling

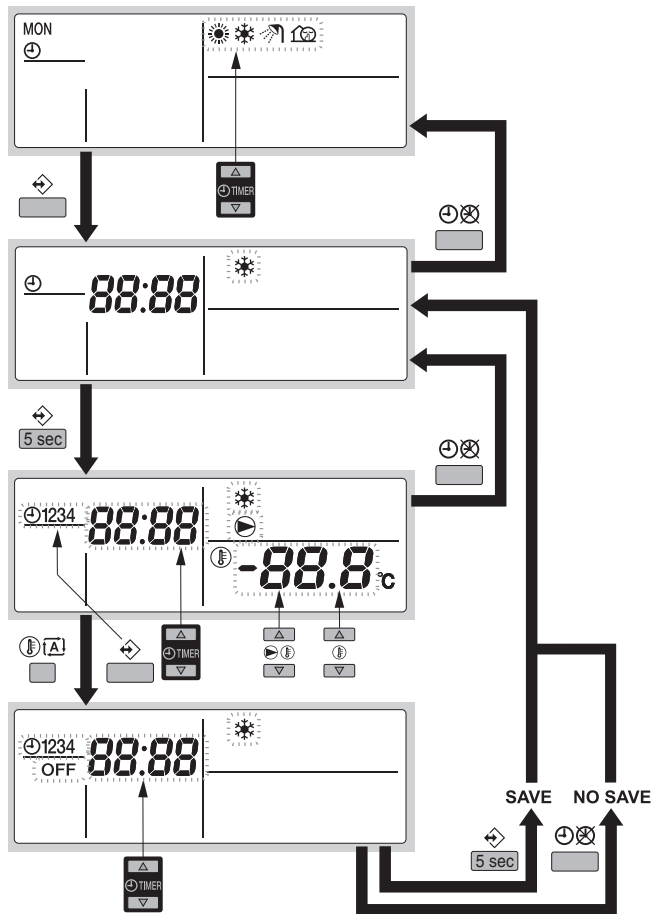

i INFORMATION

Press \odot/\oplus to return to previous steps in the programming procedure without saving modified settings.

- 1 Press \odot/\oplus to enter the programming/consulting mode.
- 2 Select the operation mode you would like to program using \odot/\uparrow and \odot/\downarrow .
Result: The actual mode is blinking.
- 3 Press \odot/\oplus to confirm the selected mode.
Result: The time is blinking.
- 4 Consult the action(s) using \odot/\uparrow and \odot/\downarrow .
- 5 Hold down \odot/\oplus for 5 seconds to program the detailed actions.
Result: The first programmed action appears.
- 6 Select the action number you would like to program or to modify using \odot/\oplus .
- 7 Set the correct action time using \odot/\uparrow and \odot/\downarrow .
- 8 Set the leaving water temperature using \odot/\uparrow and \odot/\downarrow .
- 9 Set the room temperature using \odot/\uparrow and \odot/\downarrow .
- 10 Select OFF using \odot/\uparrow to switch cooling and the remote controller off.
- 11 Repeat this procedure to program the other actions.
Result: When all actions have been programmed, make sure that the display shows the highest action number you would like to save.
- 12 Press \odot/\oplus for 5 seconds to store the programmed actions.

Result: If \diamond is pressed when action number 3 is displayed, actions 1, 2 and 3 are stored, but action 4 is deleted. You automatically return to step 6. Press \otimes/\oplus several times to return to previous steps in this procedure and finally return to normal operation.

13 You automatically return to step 6; start again to program the following day.

To program space heating

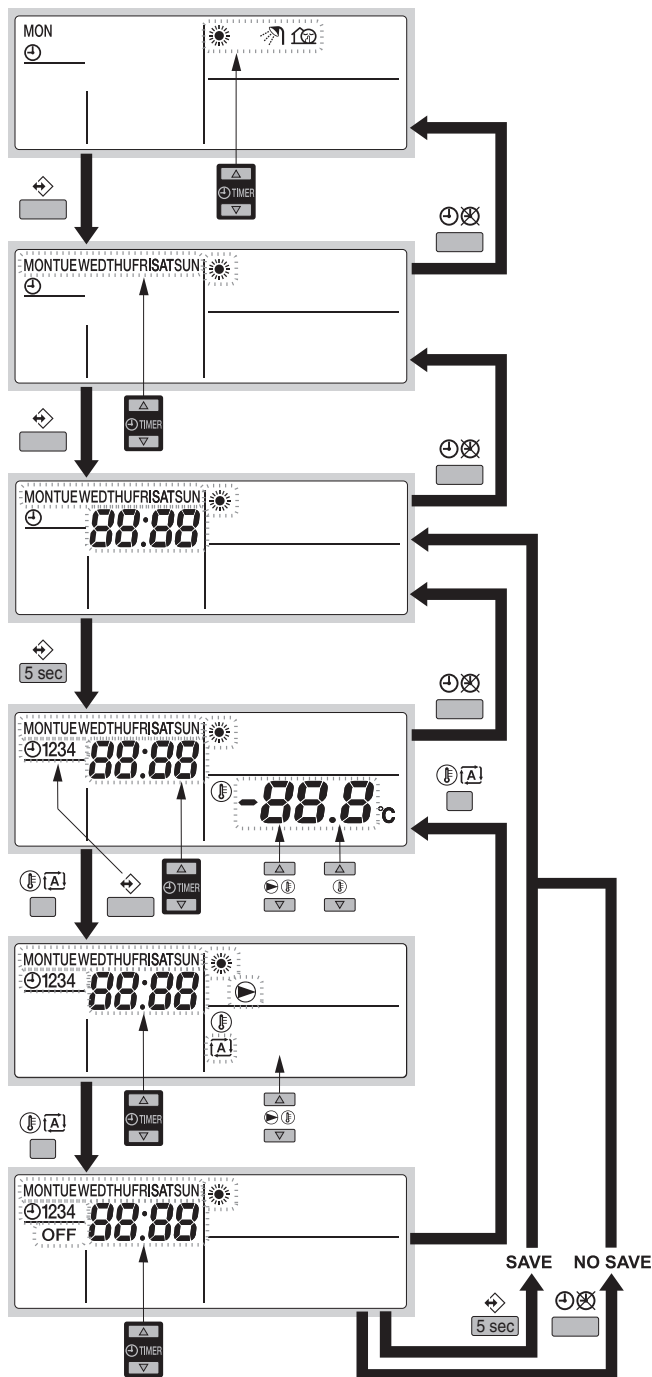

INFORMATION

Press \otimes/\oplus to return to previous steps in the programming procedure without saving modified settings.

- 1 Press \diamond to enter the programming/consulting mode.
- 2 Select the operation mode you would like to program using \oplus/\triangle and \ominus/∇ .

Result: The actual mode is blinking.

- 3 Press \diamond to confirm the selected mode.

Result: The actual day is blinking.

- 4 Select the day you would like to consult or to program using \oplus/\triangle and \ominus/∇ .

Result: The selected day is blinking.

- 5 Press \diamond to confirm the selected day.
- 6 Hold down \diamond for 5 seconds to program the detailed actions.

Result: The first programmed action of the selected day appears.

- 7 Select the action number you would like to program or to modify using \diamond .

- 8 Set the correct action time using \oplus/\triangle and \ominus/∇ .

- 9 Set the leaving water temperature using \oplus/\triangle and \ominus/∇ .

- 10 Set the room temperature using \oplus/\triangle and \ominus/∇ .

- 11 Press \oplus/\triangle to select:
 - OFF: to switch heating and the remote controller off.
 - \oplus/\triangle : to select automatic temperature calculation for leaving water temperature

- 12 Set the appropriate shift value using \oplus/\triangle and \ominus/∇ . For more information about weather dependent setpoint, see "12.3.6 Schedule timer" on page 30.

- 13 Repeat this procedure to program the other actions of the selected day.

Result: When all actions have been programmed, make sure that the display shows the highest action number you would like to save.

- 14 Press \diamond for 5 seconds to store the programmed actions.

Result: If \diamond is pressed when action number 3 is displayed, actions 1, 2 and 3 are stored, but action 4 is deleted. You automatically return to step 6. Press \otimes/\oplus several times to return to previous steps in this procedure and finally return to normal operation.

- 15 You automatically return to step 6; start again to program the following day.

- 15 You automatically return to step 6; start again to program the following day.

To program quiet mode

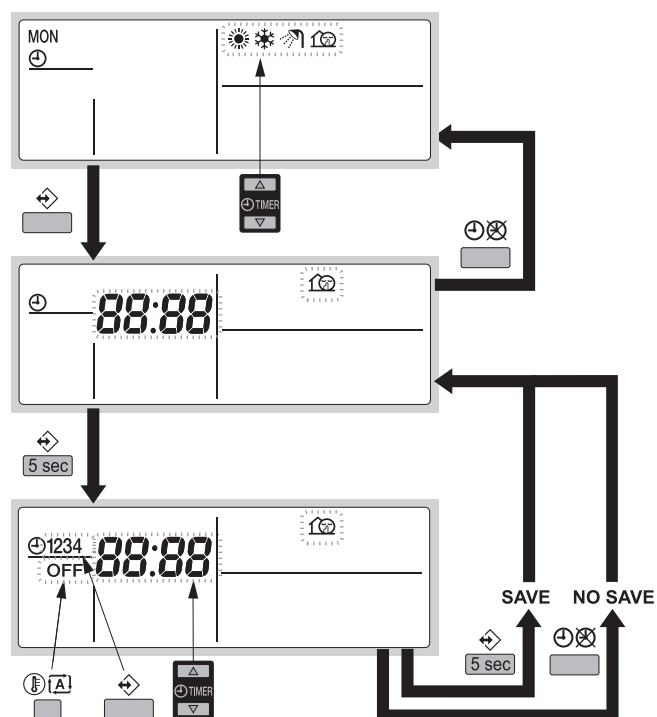

12 Operation



INFORMATION

Press $\text{⏏}/\text{⏏}$ to return to previous steps in the programming procedure without saving modified settings.

- 1 Press ⏏ to enter the programming/consulting mode.
- 2 Select the operation mode you would like to program using $\text{⏏}\text{▲}$ and $\text{⏏}\text{▼}$.
Result: The actual mode is blinking.
- 3 Press ⏏ to confirm the selected mode.
- 4 Consult the action(s) using $\text{⏏}\text{▲}$ and $\text{⏏}\text{▼}$.
- 5 Hold down ⏏ for 5 seconds to program the detailed actions.
Result: The first programmed action appears.
- 6 Select the action number you would like to program or to modify using ⏏ .
- 7 Set the correct action time using $\text{⏏}\text{▲}$ and $\text{⏏}\text{▼}$.
- 8 Select or deselect **OFF** as an action using $\text{⏏}\text{⏏}$.
- 9 Repeat this procedure to program the other actions of the selected mode.
Result: When all actions have been programmed, make sure that the display shows the highest action number you would like to save.
- 10 Press ⏏ for 5 seconds to store the programmed actions.
Result: If ⏏ is pressed when action number 3 is displayed, actions 1, 2 and 3 are stored, but action 4 is deleted. You automatically return to step 6. Press $\text{⏏}/\text{⏏}$ several times to return to previous steps in this procedure and finally return to normal operation.
- 11 You automatically return to step 6; start again to program the following day.

To consult programmed actions



INFORMATION

Press $\text{⏏}/\text{⏏}$ to return to previous steps in the consulting procedure.

- 1 Press ⏏ to enter the programming/consulting mode.
- 2 Select the operation mode you would like to consult using $\text{⏏}\text{▲}$ and $\text{⏏}\text{▼}$.
Result: The actual mode is blinking.
- 3 Press ⏏ to confirm the selected mode.
Result: The actual day is blinking.
- 4 Select the day you would like to consult using $\text{⏏}\text{▲}$ and $\text{⏏}\text{▼}$.
Result: The selected day is blinking.
- 5 Press ⏏ to confirm the selected day.
Result: The first programmed action of the selected day appears.
- 6 Consult the other programmed actions of that day using $\text{⏏}\text{▲}$ and $\text{⏏}\text{▼}$.
Result: This is called the readout mode. Empty program actions (e.g. 4) are not displayed. Press $\text{⏏}/\text{⏏}$ several times to return to previous steps in this procedure and finally return to normal operation.

Schedule timer tips and tricks

To program the next day(s)

- 1 After confirming the programmed actions of a specific day, press $\text{⏏}/\text{⏏}$ once.
Result: You can now select another day using $\text{⏏}\text{▲}$ and $\text{⏏}\text{▼}$ and restart consulting and programming.

To copy programmed actions to next day

In space heating program it is possible to copy all programmed actions of a specific day to the next day (e.g. copy all programmed actions from "MON" to "TUE").

- 2 Press ⏏ .
Result: The actual mode is blinking.
- 3 Select the mode you want to program using $\text{⏏}\text{▲}$ and $\text{⏏}\text{▼}$.
Result: The selected mode is blinking. You can leave programming by pressing $\text{⏏}/\text{⏏}$.
- 4 Press ⏏ to confirm the selected mode.
Result: The actual day is blinking.
- 5 Select the day you would like to copy to the next day using $\text{⏏}\text{▲}$ and $\text{⏏}\text{▼}$.
Result: The selected day is blinking. Press $\text{⏏}/\text{⏏}$ to return to step 2.
- 6 Press ⏏ and $\text{⏏}/\text{⏏}$ simultaneously for 5 seconds.
- 7 After 5 seconds the display will show the next day (e.g. "TUE" if "MON" was selected first). This indicates that the day has been copied.
- 8 Press $\text{⏏}/\text{⏏}$ to return to step 2.

To delete one or more programmed actions

Deleting one or more programmed actions is done at the same time as storing the programmed actions.

When all actions for one day have been programmed, make sure that the display shows the highest action number you would like to save. Pressing ⏏ for 5 seconds stores all actions except those with a higher action number than the one that is displayed.

Example: Pressing ⏏ when action number 3 is displayed, stores actions 1, 2 and 3, but deletes action 4.

12.3.7 Operating the optional demand PCB

An optional PCB EKRP1AHTA can be connected to the unit and be used to remotely control the unit.

The 3 inputs allow:

- remote switching between cooling and heating
- remote thermo on/off
- remote unit on/off

For more details about this option kit, refer to the wiring diagram of the unit.



INFORMATION

The signal (voltage free) must take at least 50 ms.

See also field setting [6-01] in "[6.2.9 Field settings on the remote controller](#)" on page 16 for setting the function of your preference.

12.3.8 Operating the optional external control adapter

An optional control adapter PCB DTA104A62 can be connected to the unit and be used to remotely control 1 or more units.

By short-circuiting contacts on the option kit PCB, you can:

- reduce capacity to about 70%,
- reduce capacity to about 40%,
- force thermo off,
- capacity save (fan low speed turn, compressor frequency control).

For more details about this option kit, refer to a separate instruction that is delivered with the unit.

12.3.9 Operating the optional remote controller

If besides the main remote controller the optional remote controller is installed as well, the main remote controller (master) can access all settings while the second remote controller (slave) can not access schedule settings and parameter settings.

Refer to the installation manual for more details.

13 Maintenance and service



WARNING

Never replace a fuse with a fuse of a wrong ampere ratings or other wires when a fuse blows out. Use of wire or copper wire may cause the unit to break down or cause a fire.



CAUTION

Do not insert fingers, rods or other objects into the air inlet or outlet. Do not remove the fan guard. When the fan is rotating at high speed, it will cause injury.



CAUTION

After a long use, check the unit stand and fitting for damage. If damaged, the unit may fall and result in injury.

Water pressure

Check whether the water pressure is above 1 bar. If it is lower, add water.

13.1 About the refrigerant

This product contains fluorinated greenhouse gases. Do NOT vent gases into the atmosphere.

Refrigerant type: R410A

Global warming potential (GWP) value: 2087.5



NOTICE

In Europe, the **greenhouse gas emissions** of the total refrigerant charge in the system (expressed as tonnes CO₂-equivalent) is used to determine the maintenance intervals. Follow the applicable legislation.

Formula to calculate the greenhouse gas emissions:
GWP value of the refrigerant × Total refrigerant charge [in kg] / 1000

Please contact your installer for more information.



WARNING

The refrigerant in the system is safe and normally does not leak. If the refrigerant leaks in the room, contact with a fire of a burner, a heater or a cooker may result in a harmful gas.

Turn off any combustible heating devices, ventilate the room and contact the dealer where you purchased the unit.

Do not use the system until a service person confirms that the portion where the refrigerant leaks is repaired.

13.2 After-sales service and warranty

13.2.1 Warranty period

- This product includes a warranty card that was filled in by the dealer at the time of installation. The completed card has to be checked by the customer and stored carefully.

- If repairs to the product are necessary within the warranty period, contact your dealer and keep the warranty card at hand.

13.2.2 Recommended maintenance and inspection

Since dust collects when using the unit for several years, performance of the unit will deteriorate to some extent. As taking apart and cleaning interiors of units requires technical expertise and in order to ensure the best possible maintenance of your units, we recommend to enter into a maintenance and inspection contract on top of normal maintenance activities. Our network of dealers has access to a permanent stock of essential components in order to keep your unit in operation as long as possible. Contact your dealer for more information.

When asking your dealer for an intervention, always state:

- The complete model name of the unit.
- The manufacturing number (stated on the nameplate of the unit).
- The installation date.
- The symptoms or malfunction, and details of the defect.

14 Troubleshooting

If one of the following malfunctions occur, take the measures shown below and contact your dealer.



WARNING

Stop operation and shut off the power if anything unusual occurs (burning smells etc.).

Leaving the unit running under such circumstances may cause breakage, electric shock or fire. Contact your dealer.

The system must be repaired by a qualified service person:

| Malfunction | Measure |
|---|--|
| If a safety device such as a fuse, a breaker or an earth leakage breaker frequently actuates or the ON/OFF switch does not properly work. | Turn off the main power switch. |
| If water leaks from the unit. | Stop the operation. |
| The operation switch does not work well. | Turn off the power. |
| If the user interface display indicates the unit number, the operation lamp flashes and the malfunction code appears. | Notify your installer and report the malfunction code. |

If the system does not properly operate except for the above mentioned cases and none of the above mentioned malfunctions is evident, investigate the system according to the following procedures.

| Malfunction | Measure |
|--|---|
| The remote controller display is blank. | <ul style="list-style-type: none"> Check if there is no power failure. Wait until power is restored. If power failure occurs during operation, the system automatically restarts immediately after power is restored. Check if no fuse has blown or breaker is activated. Change the fuse or reset the breaker if necessary. Check if the benefit kWh rate power supply is active. |
| An error code is displayed on the remote controller. | Consult your local dealer. Refer to "8.1 Error codes: Overview" on page 22 for a detailed list of error codes. |

15 Relocation

| Malfunction | Measure |
|--|---|
| The schedule timer works, but the programmed actions are executed at the wrong time. | Check if the clock and the day of the week are set correctly, and correct if necessary. |
| The schedule timer is programmed, but does not work. | In case ☹ is not displayed, push ☹/☺ to enable the schedule timer. |
| Capacity shortage. | Consult your local dealer. |
| Temperature values on the remote controller are displayed in °F instead of in °C. | To switch the display between °C and °F, push ⏮▲ and ⏮▼ simultaneously for 5 seconds. The default temperature display is in °C. |

If after checking all above items, it is impossible to fix the problem yourself, contact your installer and state the symptoms, the complete model name of the unit (with manufacturing number if possible) and the installation date (possibly listed on the warranty card).

14.1 Error codes: Overview

In case a malfunction code appears on the indoor unit user interface display, contact your installer and inform the malfunction code, the unit type, and serial number (you can find this information on the nameplate of the unit).

For your reference, a list with malfunction codes is provided. You can, depending on the level of the malfunction code, reset the code by pushing the ON/OFF button. If not, ask your installer for advice.

15 Relocation

Contact your dealer for removing and reinstalling the total unit. Moving units requires technical expertise.

16 Disposal

This unit uses hydrofluorocarbon. Contact your dealer when discarding this unit.



NOTICE

Do not try to dismantle the system yourself: the dismantling of the system, treatment of the refrigerant, oil and other parts must comply with applicable legislation. Units must be treated at a specialised treatment facility for reuse, recycling and recovery.

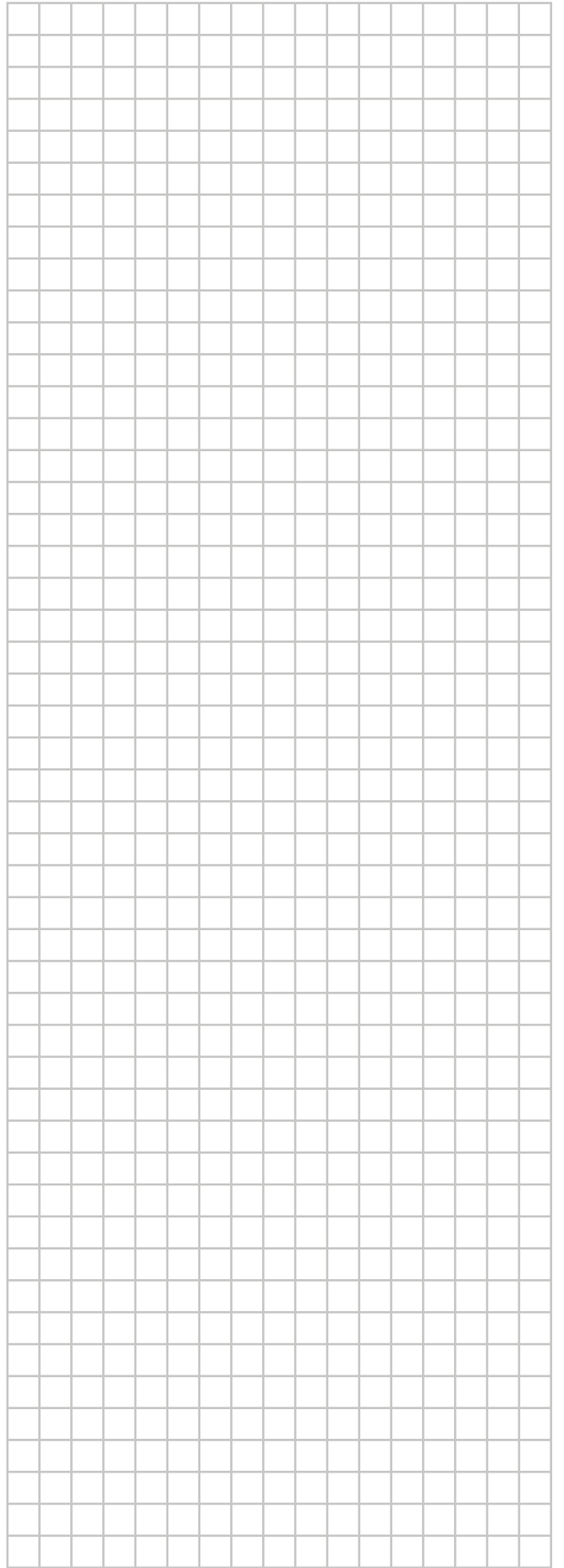

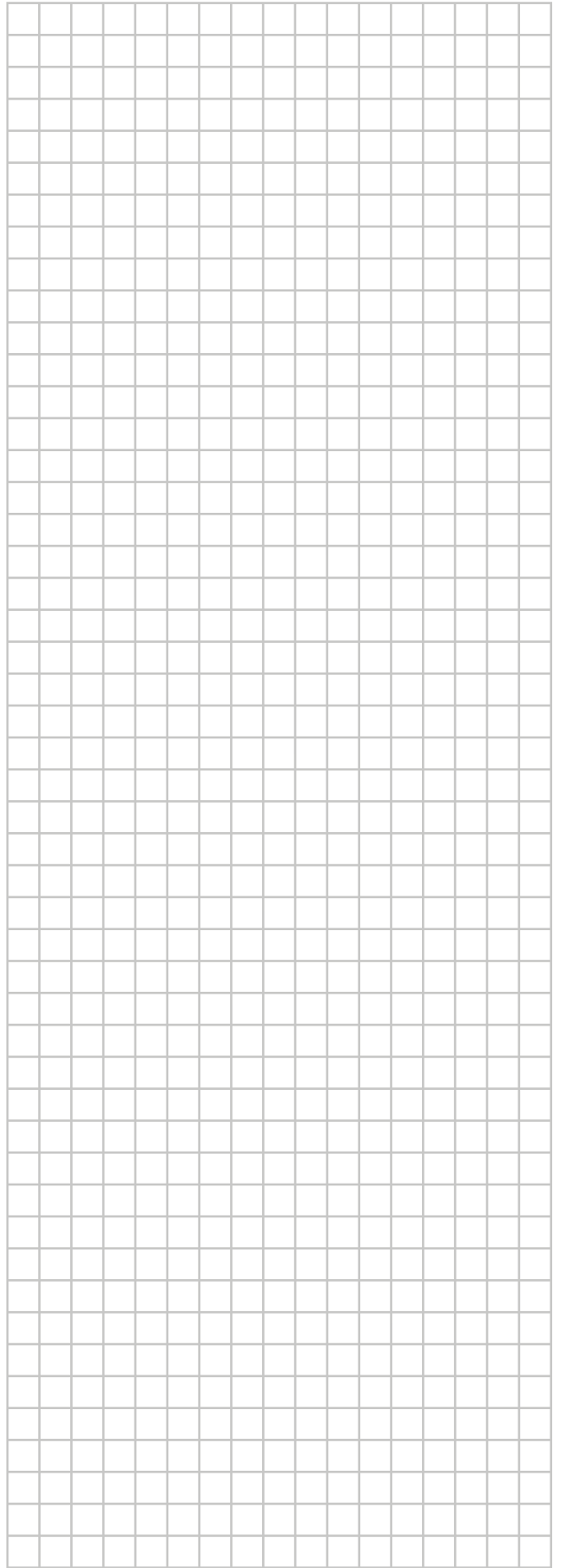
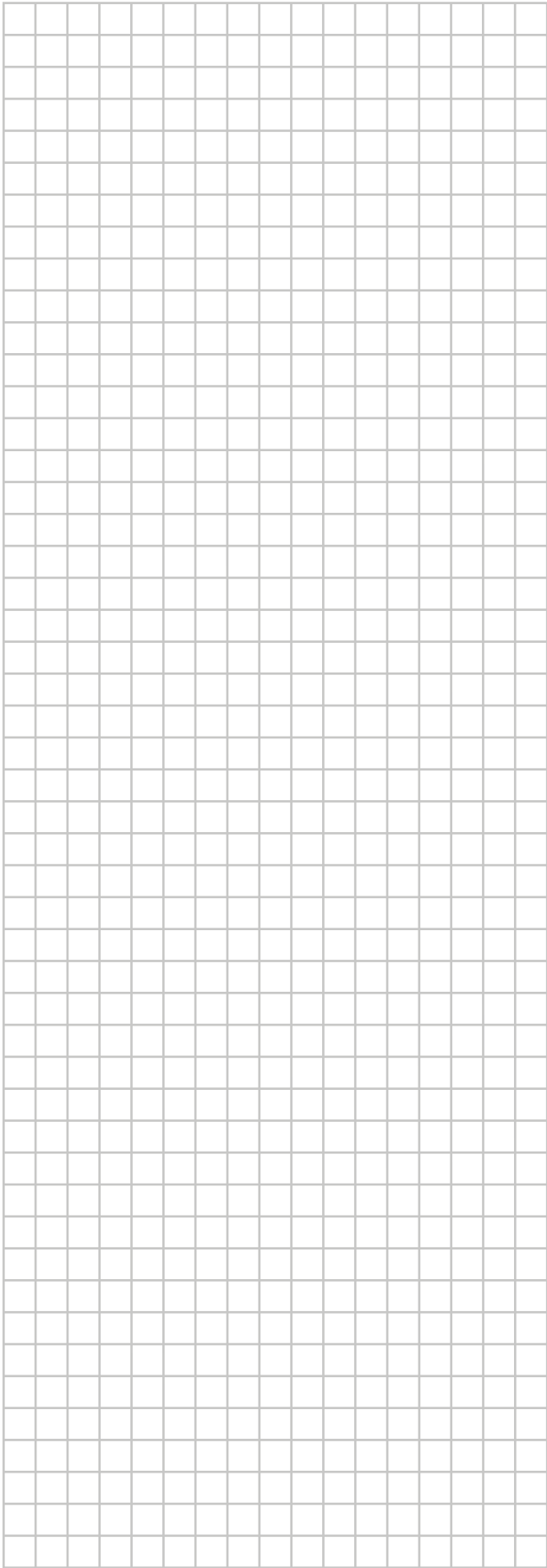



4P489435-1 B 00000004

Copyright 2017 Daikin

DAIKIN EUROPE N.V.

Zandvoordestraat 300, B-8400 Oostende, Belgium

4P489435-1B 2017.10