

DZ Series

Water cooled oil free centrifugal chillers

Operation manual



EWWD – DZ
EWWH – DZ
EWSW – DZ

Refrigerant: R134a, R1234ze, R413A
Performance according to EN14511

D-EOMWC01405-19_03EN

REV	Revision 3
Date	January 2023
Supersedes	D-EOMWC01405-19_02EN

TABLE OF CONTENTS

1	SAFETY CONSIDERATIONS	5
1.1	General	5
1.2	Before switching the unit	5
1.3	Avoid electrocution	5
2	GENERAL DESCRIPTION	6
2.1	Basic Information	6
2.2	Abbreviations used	6
2.3	Controller Operating Limits	6
2.4	Controller Architecture	6
2.5	Communication Modules	7
3	USING THE CONTROLLER	8
3.1	Navigating	9
3.2	Passwords	9
3.3	Editing	10
3.4	Basic Control System Diagnostic	10
3.5	Controller maintenance	11
3.6	Optional Remote User Interface	11
3.7	Embedded Web Interface	11
4	MENU STRUCTURE	13
4.1	Main Menu	13
4.2	View/Set Unit	13
4.2.1	Thermostat Ctrl	13
4.2.2	Network Ctrl	14
4.2.3	Pumps	14
4.2.4	Condenser	14
4.2.5	Evaporator	15
4.2.6	Master/Slave	15
4.2.6.1	<i>Data</i>	15
4.2.6.2	<i>Options</i>	16
4.2.6.3	<i>Thermostat Ctrl</i>	16
4.2.6.4	<i>Timers</i>	16
4.2.6.5	<i>Standby Chiller</i>	16
4.2.7	Rapid Restart	17
4.2.8	Date/Time	17
4.2.9	Scheduler	17
4.2.10	Power Conservation	17
4.2.11	Controller IP setup	18
4.2.12	Daikin on Site	18
4.2.13	Software Options	19
4.2.13.1	<i>Changing the Password for buying new Software Options</i>	19
4.2.13.2	<i>Inserting the Password in a Spare Controller</i>	19
4.2.13.3	<i>Modbus MSTP Software Option</i>	21
4.2.13.4	<i>BACNET MSTP</i>	22
4.2.13.5	<i>BACNET IP</i>	23
4.2.14	Menu Password	23
4.3	Active Setpoint	24
4.4	Evaporator LWT	24
4.5	Condenser LWT	24
4.6	Unit Capacity	24
4.7	Unit Mode	24
4.8	Unit Enable	25
4.9	Timers	25
4.10	Alarms	25

4.11	Commission Unit	25
4.11.1	Alarm Limits	25
4.11.2	Calibrate Sensors	26
4.11.2.1	Unit Calibrate Sensors	26
4.11.2.2	Compressor Calibrate Sensors	26
4.11.3	Scheduled Maintenance	26
4.12	About this Chiller	26
5	WORKING WITH THIS UNIT	27
5.1	Unit Setup	27
5.1.1	Control Source	27
5.1.2	Available Mode Setting	27
	It has to be noted that in case the selected mode cannot be managed by the unit, it will revert to Cool.	28
5.1.3	Temperature Settings	28
5.1.3.1	LWT Setpoint Setting	28
5.1.3.2	Thermostat Control Settings	28
5.1.3.3	Pumps	29
5.1.4	Power Conservation	29
5.1.4.1	Demand Limit	29
5.1.4.2	Current Limit (Optional)	30
5.1.4.3	Setpoint Reset	30
5.1.4.4	Setpoint Reset by External 4-20 mA Signal	30
5.1.4.5	Setpoint Reset by Evaporator Return Temperature	30
5.1.4.6	Soft Load	31
5.1.5	Date/Time	31
5.1.5.1	Date, Time and UTC Settings	31
5.1.6	Scheduler	31
5.2	Unit Start-up	31
5.2.1	Unit Status	31
5.2.2	Prepare the unit to start	32
5.2.2.1	Unit Switch Enable	32
5.2.3	Keypad Enable	32
5.2.3.1	BMS Enable	32
5.3	Condensation Control	33
6	ALARMS AND TROUBLESHOOTING	34
6.1	Unit Alerts	34
6.1.1	Bad Demand Limit Input	34
6.1.2	Bad Leaving Water Temperature Reset Input	34
6.1.3	Condenser Pump #1 Failure (W/C units only)	34
6.1.4	Condenser Pump #2 Failure (W/C units only)	35
6.1.5	Evaporator Pump #1 Failure	35
6.1.6	Evaporator Pump #2 Failure	35
6.1.7	External Event	36
6.1.8	Password Over Time	36
6.2	Unit Pumpdown Stop Alarms	36
6.2.1	Condenser Entering Water Temperature (EWT) sensor fault	36
6.2.2	Condenser Leaving Water Temperature (LWT) sensor fault	36
6.2.3	Evaporator Entering Water Temperature (EWT) sensor fault	37
6.2.4	Evaporator Water Temperatures inverted	37
6.2.5	Liquid Temperature Sensor fault	37
6.3	Unit Rapid Stop Alarms	38
6.3.1	PVM alarm (A/C units only)	38
6.3.2	Condenser Water Freeze alarm (W/C units only)	38
6.3.3	Condenser Water Flow Loss alarm (W/C units only)	38
6.3.4	Emergency Stop	39
6.3.5	Evaporator Flow Loss alarm	39
6.3.6	Evaporator Leaving Water Temperature (LWT) sensor fault	39

6.3.7	Evaporator Water Freeze alarm	40
6.3.8	External alarm	40
6.3.9	Gas Leakage Alarm	40
6.3.10	Power Fault.....	41
6.3.11	Low Discharge Superheat	41
6.3.12	Mechanical High Pressure Switch Alarm	42
6.3.13	High Pressure Alarm	42
6.3.14	Low Pressure Alarm	43
6.3.15	Compressor Extension Communication Error	44
6.3.16	EXV Driver Extension Communication Error.....	44
6.3.1	Hot Gas Bypass Driver Extension Communication Error	44
6.4	Compressor Alerts	45
6.4.1	Power Loss	45
6.5	Circuit Pumpdown Stop Alarms	45
6.5.1	Low Discharge Superheat fault	45
6.5.2	Suction Temperature Sensor fault.....	45
6.6	Circuit Rapid Stop Alarms	46
6.6.1	Compressor VFD Fault.....	46
6.6.2	High Motor Current Alarm.....	46
6.6.3	High Motor Temperature Alarm	46
6.6.4	Overvoltage Alarm	47
6.6.5	Undervoltage Alarm	47
6.6.6	Compressor Lockout Fault	47
6.6.7	Compressor Fault	48
6.6.1	Compressor Sensor Fault.....	48
6.6.2	BMC Fault.....	48
6.6.3	Suction Pressure Sensor Fault.....	49
6.6.4	Discharge Pressure Sensor Fault	49
6.6.5	Check Valve Leakage.....	49
6.6.6	Compressor Bearing Fault.....	50
6.6.7	Discharge Temperature Sensor Fault	50
6.6.8	VFD Communication Failure	50
7	OPTIONS.....	51
7.1	Energy Meter including Current Limit (Optional)	51
7.2	Rapid Restart (Optional)	51

1 SAFETY CONSIDERATIONS

1.1 General

Installation, start-up and servicing of equipment can be hazardous if certain factors particular to the installation are not considered: operating pressures, presence of electrical components and voltages and the installation site (elevated plinths and built-up up structures). Only properly qualified installation engineers and highly qualified installers and technicians, fully trained for the product, are authorized to install and start-up the equipment safely.

During all servicing operations, all instructions and recommendations, which appear in the installation and service instructions for the product, as well as on tags and labels fixed to the equipment and components and accompanying parts supplied separately, must be read, understood and followed.

Apply all standard safety codes and practices.

Wear safety glasses and gloves.

Use the proper tools to move heavy objects. Move units carefully and set them down gently.



Do not operate on a faulty fan, pump or compressor before the main switch has been shut off. Overtemperature protection is auto-reset, therefore the protected component may restart automatically if temperature conditions allow it.

In some unit a push button is placed on a door of the unit electrical panel. The button is highlighted by a red color in yellow background. A manual pressure of the emergency stop button stops all loads from rotating, thus preventing any accident which may occur. An alarm is also generated by the Unit Controller. Releasing the emergency stop button enables the unit, which may be restarted only after the alarm has been cleared on the controller.



The emergency stop causes all motors to stop, but does not switch off power to the unit. Do not service or operate on the unit without having switched off the main switch.

1.2 Before switching the unit

Before switching on the unit read the following recommendations:

- When all the operations and all the settings have been carried out, close all the switchbox panels
- The switchbox panels can only be opened by trained personnel
- When the UC requires to be accessed frequently the installation of a remote interface is strongly recommended
- LCD display of the unit controller may be damaged by extremely low temperatures (see chapter 2.4). For this reason, it is strongly recommended to never power off the unit during winter, especially in cold climates.

1.3 Avoid electrocution

Only personnel qualified in accordance with IEC (International Electrotechnical Commission) recommendations may be permitted access to electrical components. It is particularly recommended that all sources of electricity to the unit be shut off before any work is begun. Shut off main power supply at the main circuit breaker or isolator.

IMPORTANT: This equipment uses and emits electromagnetic signals. Tests have shown that the equipment conforms to all applicable codes with respect to electromagnetic compatibility.



RISK OF ELECTROCUTION: Even when the main circuit breaker or isolator is switched off, certain circuits may still be energized, since they may be connected to a separate power source.



RISK OF BURNS: Electrical currents cause components to get hot either temporarily or permanently. Handle power cable, electrical cables and conduits, terminal box covers and motor frames with great care.



ATTENTION: In accordance with the operating conditions the fans can be cleaned periodically. A fan can start at any time, even if the unit has been shut down.

2 GENERAL DESCRIPTION

2.1 Basic Information

MicroTech is a system for controlling single or dual-circuit air/water-cooled liquid chillers. MicroTech controls compressor start-up necessary to maintain the desired heat exchanger leaving water temperature. In each unit mode it controls the operation of the condensers to maintain the proper condensation process in each circuit.

Safety devices are constantly monitored by MicroTech to ensure their safe operation. MicroTech also gives access to a Test routine covering all inputs and outputs. All MicroTech controls can work in accordance with three independent modes:

- Local mode: the machine is controlled by commands from the user interface.
- Remote mode: the machine is controlled by remote contacts (voltage-free contacts).
- Network mode: the machine is controlled by commands from a BAS system. In this case, a data communication cable is used to connect the unit to the BAS.

When the MicroTech system operates autonomously (Local or Remote mode) it retains all of its own control capabilities but does not offer any of the features of the Network mode. In this case monitoring of the unit operational data is still allowed.

2.2 Abbreviations used

In this manual, the refrigeration circuits are called circuit #1 and circuit #2. The compressor in circuit #1 is labelled Cmp1. The other in circuit #2 is labelled Cmp2. The following abbreviations are used:

A/C	Air Cooled
CEWT	Condenser Entering Water Temperature
CLWT	Condenser Leaving Water Temperature
CP	Condensing Pressure
CSRT	Condensing Saturated Refrigerant Temperature
DSH	Discharge Superheat
DT	Discharge Temperature
E/M	Energy Meter Module
EEWT	Evaporator Entering Water Temperature
ELWT	Evaporator Leaving Water Temperature
EP	Evaporating Pressure
ESRT	Evaporating Saturated Refrigerant Temperature
EXV	Electronic Expansion Valve
HMI	Human Machine Interface
MOP	Maximum operating pressure
SSH	Suction SuperHeat
ST	Suction Temperature
UC	Unit controller (MicroTech)
W/C	Water Cooled

2.3 Controller Operating Limits

Operation (IEC 721-3-3):

- Temperature -40...+70 °C
- Restriction LCD -20... +60 °C
- Restriction Process-Bus -25...+70 °C
- Humidity < 90 % r.h (no condensation)
- Air pressure min. 700 hPa, corresponding to max. 3,000 m above sea level

Transport (IEC 721-3-2):

- Temperature -40...+70 °C
- Humidity < 95 % r.h (no condensation)
- Air pressure min. 260 hPa, corresponding to max. 10,000 m above sea level.

2.4 Controller Architecture

The overall controller architecture is the following:

- One MicroTech main controller
- I/O extensions as needed depending on the configuration of the unit
- Communications interface(s) as selected
- Peripheral Bus is used to connect I/O extensions to the main controller.

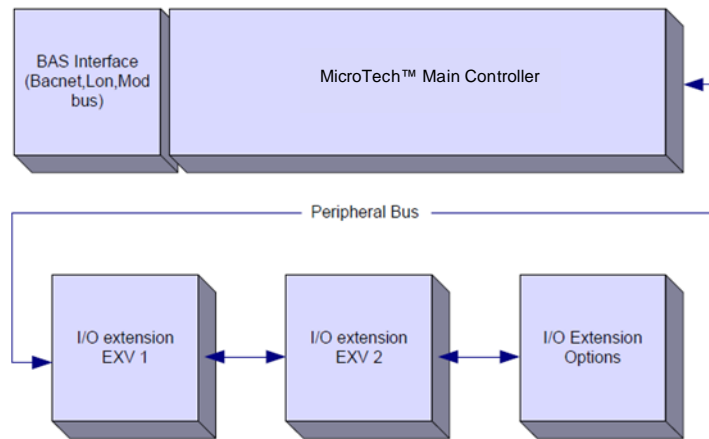

Controller/ Extension Module	Siemens Part Number	Address	Usage
	EWWD/H-VZ		
Main Controller	POL687.00/MCQ	n/a	Used on all configurations
Extension Module	POL965.00/MCQ	2	Used on all configurations
EEXV Module 1	POL94U.00/MCQ	3	Used on all configurations
EEXV Module 2	POL94U.00/MCQ	7	Used on some configurations
HGBP Module	POL94U.00/MCQ	5	Optional

All boards are supplied from a common 24 Vac source. Extension boards can be directly powered by the Unit Controller. All boards can be also supplied by a 24Vdc source.



CAUTION: Maintain the correct polarity when connecting the power supply to the boards, otherwise the peripheral bus communication will not operate and the boards may be damaged.

2.5 Communication Modules

Any of the following modules can be connected directly to the left side of the main controller to allow a BAS or other remote interface to function. Up to three can be connected to the controller at a time. The controller should automatically detect and configure itself for new modules after booting up. Removing modules from the unit will require manually changing the configuration.

Module	Siemens Part Number	Usage
BacNet/IP	POL908.00/MCQ	Optional
Lon	POL906.00/MCQ	Optional
Modbus	POL902.00/MCQ	Optional
BACnet/MSTP	POL904.00/MCQ	Optional

3 USING THE CONTROLLER

The control system consists of a unit controller (UC) equipped with a set of extension modules that implement additional features. All boards communicate via an internal peripheral bus with the UC. The UC continuously manages the information received from the various pressure and temperature probes installed on the unit. The UC incorporates a program that controls the unit.

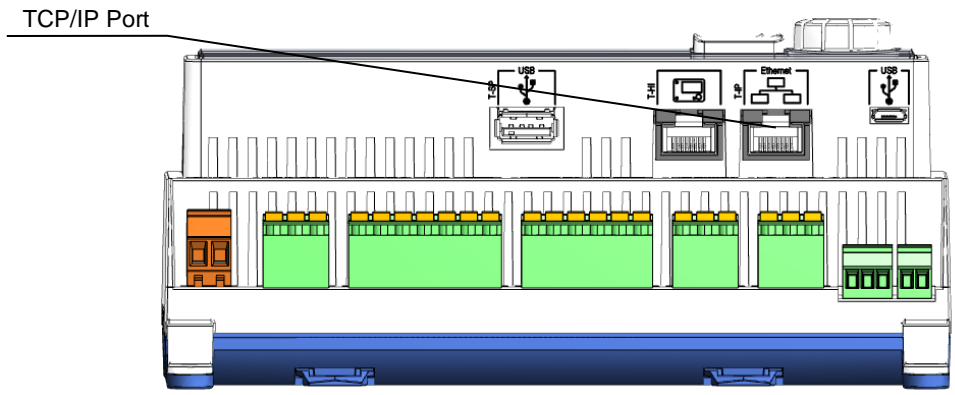

MicroTech, POL688.80 Controller

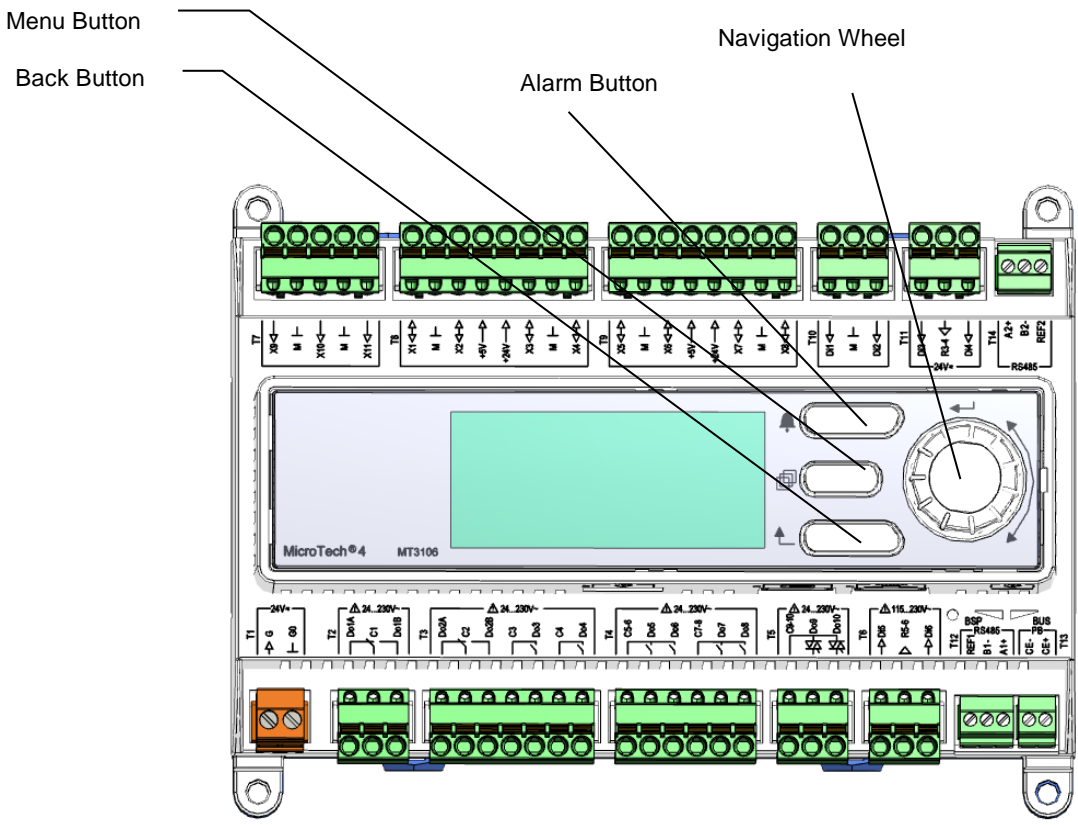

Inbuilt HMI (A/C units)

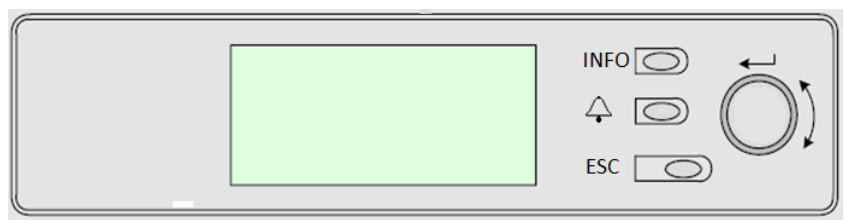

This HMI is provided of three buttons and one wheel button.

	Alarm status (from any page it links with the page with alarm list, alarm log and alarm snapshot if available)
INFO	Back to Main Page
ESC	Back to the previous level (it can be the Main Page)
Wheel Button	Used to scroll between the different menu pages, settings and data available on the HMI for the active password level. Rotating the wheel allows to navigate between lines on a screen (page) and to increase and decrease changeable values when editing. Pushing the wheel acts as an Enter Button and will jump from a link to the next set of parameters.

3.1 Navigating

When power is applied to the control circuit, the controller screen will be active and display the Home screen, which can also be accessed by pressing the Menu Button. The navigating wheel is the only navigating device necessary, although the MENU, ALARM, and BACK buttons can provide shortcuts as explained previously.

An example of the HMI screens is shown in the following picture.

M a i n M e n u	1 / 11
E n t e r P a s s w o r d	▶
U n i t S t a t u s =	
O f f : U n i t S W	
A c t i v e S e t p t =	7 . 0 ° C

A bell ringing in the top right corner will indicate an active alarm. If the bell doesn't move it means that the alarm has been acknowledged but not cleared because the alarm condition hasn't been removed. A LED will also indicate where the alarm is located between the unit or circuits.

M a i n M e n u	1 / 
E n t e r P a s s w o r d	▶
U n i t S t a t u s =	
O f f : U n i t S W	
A c t i v e S e t p t =	7 . 0 ° C

The active item is highlighted in contrast, in this example the item highlighted in Main Menu is a link to another page. By pressing the push'n'roll, the HMI will jump to a different page. In this case the HMI will jump to the Enter Password page.

E n t e r P a s s w o r d	2 / 2
E n t e r P W	* * * *

3.2 Passwords

The HMI structure is based on access levels that means that each password will disclose all the settings and parameters allowed to that password level. Basic informations about the status can be accessed without the need to enter the password. The user UC handles two level of passwords:

USER	5321
MAINTENANCE	2526

The following information will cover all data and settings accessible with the maintenance password. User password will disclose a subset of the settings explained in chapter 4.

In the Enter Password screen, the line with the password field will be highlighted to indicate that the field on the right can be changed. This represents a setpoint for the controller. Pressing the push'n'roll the individual field will be highlighted to allow an easy introduction of the numeric password. By changing all fields, the 4 digits password will be entered and, if correct, the additional settings available with that password level will be disclosed.

E n t e r P a s s w o r d	2 / 2
E n t e r P W	5 * * *

The password will time out after 10 minutes and is cancelled if a new password is entered or the control powers down. Entering an invalid password has the same effect as continuing without a password. It is changeable from 3 to 30 minutes via the Timer Settings menu in the Extended Menus.

3.3 Editing

The Editing Mode is entered by pressing the navigation wheel while the cursor is pointing to a line containing an editable field. Once in the edit mode pressing the wheel again causes the editable field to be highlighted. Turning the wheel clockwise while the editable field is highlighted causes the value to be increased. Turning the wheel counter-clockwise while the editable field is highlighted causes the value to be decreased. The faster the wheel is turned, the faster the value is increased or decreased. Pressing the wheel again cause the new value to be saved and the keypad/display to leave the edit mode and return to the navigation mode.

3.4 Basic Control System Diagnostic

MicroTech controller, extension modules and communication modules are equipped with two status LED (BSP and BUS) to indicate the operational status of the devices. The BUS LED indicates the status of the communication with the controller. The meaning of the two status LED is indicated below.

Main Controller (UC)

BSP LED	Mode
Solid Green	Application running
Solid Yellow	Application loaded but not running (*) or BSP Upgrade mode active
Solid Red	Hardware Error (*)
Flashing Green	BSP startup phase. The controller needs time for starting.
Flashing Yellow	Application not loaded (*)
Flashing Yellow/Red	Fail safe mode (in case that the BSP upgrade was interrupted)
Flashing Red	BSP Error (software error*)
Flashing Red/Green	Application/BSP update or initalization

(*) Contact Service.

Extension modules

BSP LED	Mode	BUS LED	Mode
Solid Green	BSP running	Solid Green	Communication running, I/O working
Solid Red	Hardware Error (*)	Solid Red	Communication down (*)
Flashing Red	BSP Error (*)	Solid Yellow	Communication running but parameter from the application wrong or missing, or uncorrect factory calibration
Flashing Red/Green	BSP upgrade mode		

Communication modules

BSP LED (same for all modules)

BSP LED	Mode
Solid Green	BPS running, communication with controller
Solid Yellow	BSP running, no communication with controller (*)
Solid Red	Hardware Error (*)
Flashing Red	BSP Error (*)
Flashing Red/Green	Application/BSP update

(*) Contact Service.

BUS LED

BUS LED	LON	Bacnet MSTP	Bacnet IP	Modbus
Solid Green	Ready for Communication. (All Parameter loaded, Neuron configured). Doesn't indicate a communication with other devices.	Ready for Communication. The BACnet Server is started. It doesn't indicate an active communication	Ready for Communication. The BACnet Server is started. It doesn't indicate an active communication	All Communication running
Solid Yellow	Startup	Startup	Startup. The LED stays yellow until the module receives a IP Address, therefore a link must be established.	Startup, or one configured channel not communicating to the Master
Solid Red	No Communication to Neuron (internal error, could be solved by downloading a new LON application)	BACnet Server down. Automatically a restart after 3 seconds are initiated.	BACnet Server down. Automatic restart after 3 seconds is initiated.	All configured Communications down. Means no communication to the Master. The timeout can be configured. In case that the timeout is zero the timeout is disabled.

BUS LED	LON	Bacnet MSTP	Bacnet IP	Modbus
Flashing Yellow	Communication not possible to the Neuron. The Neuron must be configured and set online over the LON Tool.			

3.5 Controller maintenance

The controller requires to maintain the installed battery. Every two years it's required to replace the battery. Battery model is: BR2032 and it is produced by many different vendors.

To replace the battery remove the plastic cover of the controller display using a screw driver as shown in the following pictures:

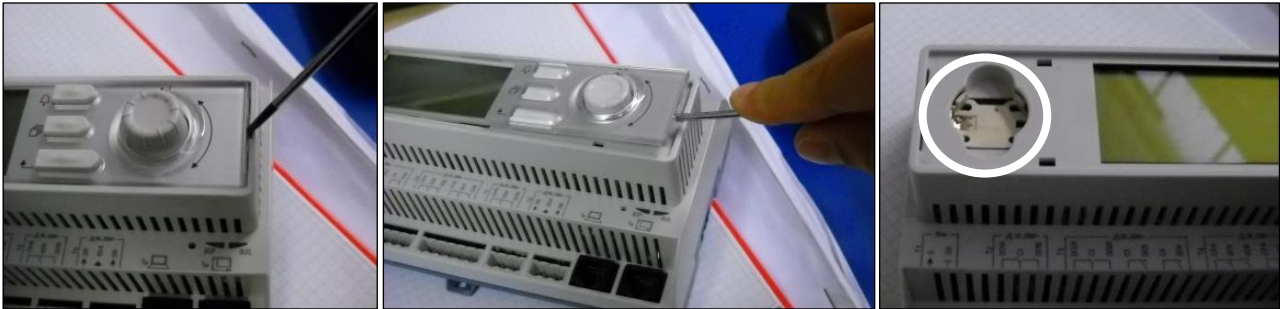

Be careful to avoid damages to the plastic cover. The new battery shall be placed in the proper battery holder which is highlighted in the picture, respecting the polarities indicated into the holder itself.

3.6 Optional Remote User Interface

As an option an external Remote HMI can be connected on the UC. The Remote HMI offers the same features as the inbuilt display plus the alarm indication done with a light emitting diode located below the bell button.

The Remote can be ordered with the unit and shipped loose as a field installed option. It can also be ordered any time after chiller shipment and mounted and wired on the job as explained on the following page. The remote panel is powered from the unit and no additional power supply is required.

All viewing and setpoint adjustments available on the unit controller are available on the remote panel. Navigation is identical to the unit controller as described in this manual.

The initial screen when the remote is turned on shows the units connected to it. Highlight the desired unit and press the wheel to access it. The remote will automatically show the units attached to it, no initial entry is required.

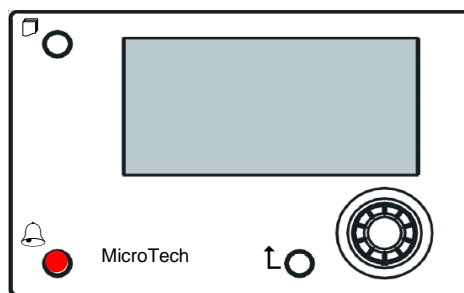

The Remote HMI can be extended up to 700m using the process bus connection available on the UC. With a daisy-chain connection as below, a single HMI can be connected to up to 8 units. Refer to the specific HMI manual for details.

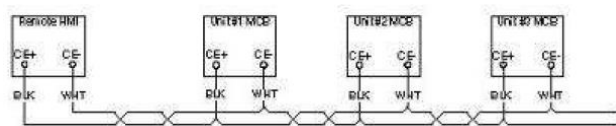

3.7 Embedded Web Interface

The MicroTech controller has an embedded web interface that can be used to monitor the unit when connected to a local network. It is possible to configure the IP addressing of the MicroTech as a fixed IP or DHCP depending on the network configuration.

With a common web browser a PC can connect with the unit controller entering the IP address of the controller or the host name, both visible in the "About Chiller" page accessible without entering a password.

When connected, it will be required to enter a user name and a password. Enter the following credential to get access to the web interface:

User Name: Daikin

Password: Daikin@Web

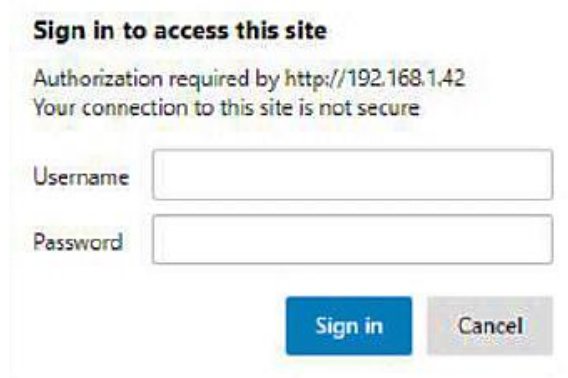

The Main Menu page will be displayed. The page is a copy of the onboard HMI and follows the same rules in terms of access levels and structure.

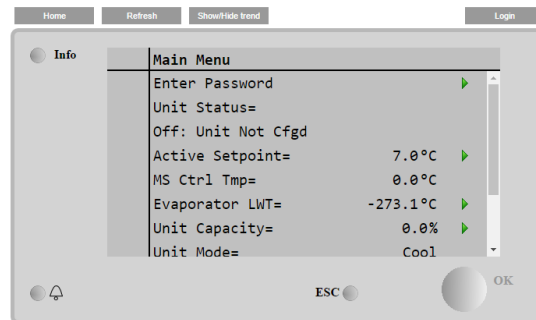

In addition it allows to trend log a maximum of 5 different quantities. It's required to click on the value of the quantity to monitor and the following additional screen will become visible:

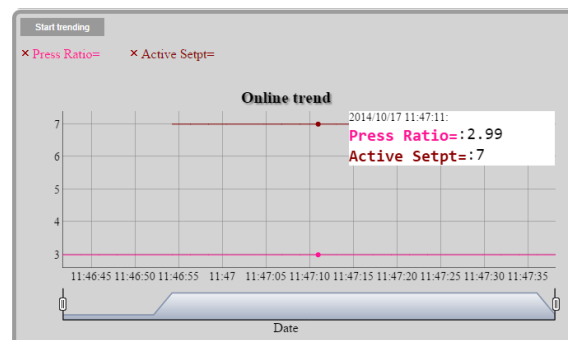

Depending on the web browser and its version the trend log feature may not be visible. It's required a web browser supporting HTML 5 like for example:

- Microsoft Internet Explorer v.11,
- Google Chrome v.37,
- Mozilla Firefox v.32.

These software are only an example of the browser supported and the versions indicated have to be intended as minimum versions.

4 MENU STRUCTURE

All settings are divided in different menus. Each menu collects in a single page other sub-menus, settings or data related to a specific function (for example Power Conservation or Setup) or entity (for example Unit or Circuit). In any of the following pages, a grey box will indicate changeable values and the defaults.

4.1 Main Menu

Setpoint/Sub-Menu	Default	Range	Description
Enter Password	▶	-	Submenu to activate access levels
View/Set Unit	▶	-	Submenu for unit data and settings
View/Set Circuit	▶	-	Submenu for circuit data and settings
Unit Status=	Off: Unit Sw	Auto Off: All Cir Disabled Off: Unit Alarm Off: Keypad Disable Off: Master Disable Off: BAS Disable Off: Unit Sw Off: Test Mode Off: Schedule Disable Auto: Wait For Load Auto: Water Recir Auto: Wait For Flow Auto: Pumpdn Auto: Max Pulldn Auto: Unit Cap Limit Auto: Current Limit	Status of the Unit
Active Setpoint=	7.0°C, ▶	-	Water temperature active setpoint + link to Setpoint page
MS Ctrl Tmp=	-273.1°C, ▶	-	Master slave controlled temperature + link to Master Slave Data page
Evaporator LWT=	-273.1°C, ▶	-	Evaporator leaving water temperature + link to Temperatures page
Condenser LWT=	-273.1°C, ▶	-	Condenser leaving water temperature + link to Temperatures page (W/C units only)
Unit Capacity=	0.0%,▶	-	Unit capacity + link to Capacity page
Unit Mode=	Cool, ▶	-	Unit Mode + link to Available modes page
Unit Enable=	Enable, ▶	-	Unit Enable state + link to unit and circuits enable page
Timers	▶	-	Submenu for unit timers
Alarms	▶	-	Submenu for alarms; same function as Bell Button
Commission Unit	▶	-	Submenu for commission unit
About Chiller	▶	-	Application Info submenu

4.2 View/Set Unit

Setpoint/Sub-Menu	Default	Range	Description
Thermostat Ctrl	▶	-	Submenu for Thermostatic control
Network Ctrl	▶	-	Submenu for Network control
Pumps	▶	-	Submenu for pump settings
Condenser	▶	-	Submenu for Condenser tower control
Evaporator	▶	-	Submenu for Evaporator three way valve control
Master/Slave	▶	-	Submenu for Master Slave data and settings
Rapid Restart	▶	-	Submenu for Rapid Restart Option
Date/Time	▶	-	Submenu Date, Time and Quiet Night mode schedule
Scheduler	▶	-	Submenu for Time Scheduler
Power Conservation	▶	-	Submenu Unit Limiting functions
Electrical Data	▶	-	Submenu for electrical data
Ctrl IP Setup	▶	-	Submenu for controller IP-address setup
Daikin on Site	▶	-	Submenu for connection to Daikin cloud DoS
Menu Password	▶	-	Submenu Disable Password for User level

4.2.1 Thermostat Ctrl

This page resumes all the parameters related to the unit thermostatic control.

Setpoint/Sub-Menu	Default	Range	Description
Start Up DT=	2.7°C	0.0...5.0°C	Offset to start thermostat control
Shut Dn DT=	1.5°C	0.0...1.7°C	Offset to standby
Stg Up DT=	0.5°C	0.0...1.7°C	Offset to allow compressor starts
Stg Dn DT=	1.0°C	0.0...1.7°C	Offset to force one compressor off
Stg Up Delay=	3 min	0...60 min	Compressor start interstage
Stg Dn Delay=	3 min	3...30 min	Compressor stop interstage
Strt Strt Dly=	15min	15...60 min	Compressor Start to Start delay
Stop Strt Dly=	3min	3...20 min	Compressor Stop to Start delay
Ice Cycle Dly=	12h	1...23h	Ice cycle delay
Lt Ld Stg Dn %=	40%	20...50%	Circuit capacity threshold to stage down one compressor
Hi Ld Stg Up %=	50%	50...100%	Circuit capacity threshold to stage up one compressor
Next Cmp On=	0	-	Shows next circuit to be started up
Next Cmp Off=	0	-	Shows next circuit number to be stopped

4.2.2 Network Ctrl

This page resumes all settings related to Network control.

Setpoint/Sub-Menu	Default	Range	Description
Control Source=	Local	Local, Network	Control source selection: Local/BMS
Act Ctrl Src=	N/A	Local, Network	Active control between Local/BMS
Netwrk En SP=	Disable	Enable, Disable	Enable unit command from BMS
Netwrk Mode SP=	Cool	-	Cool, Ice, Heat (NA), Cool/Heat Recovery
Netwrk Cool SP=	6.7°C	-	Cooling setpoint from BMS
Netwrk Cap Lim=	100%	-	Capacity limitation from BMS
Network Heat SP=	45.0°C	-	Heating setpoint from BMS
Remote Srv En=	Disable	Enable, Disable	Remote server enable

4.2.3 Pumps

This page contains the settings to define the operation of the primary/backup pumps, the running hours of each pump and all parameters to configure the behavior of the pump driven with an inverter.

Setpoint/Sub-Menu	Default	Range	Description
Evp Pmp Ctrl=	#1 Only	#1 Only, #2 Only, Auto, #1 Primary, #2 Primary	Set number of Evaporator pumps operational and which priority.
Evap Recirc Tm=	30s	0...300s	Water recirculating timer
Evap Pmp 1 Hrs=	0h		Running Hours Evaporator Pump 1 (if present)
Evap Pmp 2 Hrs=	0h		Running Hours Evaporator Pump 2 (if present)
Speed 1=	N/A	0-100%	Speed when the input Double Speed Switch is open
Cnd Pump Ctrl=	#1 Only	#1 Only, #2 Only, Auto, #1 Primary, #2 Primary	Set number of Condenser pumps operational and which priority.
Cond Pmp 1 Hrs=	0h		Running Hours Condenser Pump 1 (if present)
Cond Pmp 2 Hrs=	0h		Running Hours Condenser Pump 2 (if present)

4.2.4 Condenser

This page contains basics settings for condensation control described in section 5.3.

Setpoint/Sub-Menu	Default	Range	Description
Cond LWT	-273.1°C	-	Present value of Condenser Leaving Water Temperature
Cond EWT	-273.1°C	-	Present value of Condenser Entering Water Temperature
# Tower Running		1...4	Actual number of tower steps
Bypass Position	0%	0...100%	Present value of Bypass Valve
Fan VFD Speed	0%	0...100%	Present value of Condenser Fan Speed
Tower Control	None	None, Cond EWT	Regulation measurement
Num Fan Stages	1	1...4	Number of fan stages
Fan Stage 1 On	25.0 °C	19.0...55.0 °C	Setpoint for activation of Tower 1
Fan Stage 2 On	27.0 °C	26.0...55.0 °C	Setpoint for activation of Tower 2
Fan Stage 3 On	29.0 °C	28.0...55.0 °C	Setpoint for activation of Tower 3
Fan Stage 4 On	31.0 °C	30.0...55.0 °C	Setpoint for activation of Tower 4
Fan Stage Off Diff	1.5 °C	0.1...5.0 °C	Differential for deactivation of Towers
Stage On Delay	2min	1...60min	Delay for fan stage on
Stage Off Delay	5min	1...60min	Delay for fan stage down
Stage On @	80%	0...100%	Fan speed for stage up of additional fan
Stage Off @	30%	0...100%	Fan speed for stage down of one fan
Valve/Vfd Control	None	None, Valve Setpoint, Valve Stage, VFD Stage, Valve SP/VFD Stage	Regulation method
Valve Type	NC to Tower	NC to tower, NO to Tower	Type of bypass valve to tower
Valve/VFD SP=	18.33°C	15.6...48.9°C	Setpoint for bypass valve and vfd
Valve Min Pos	10%	0...100%	Valve minimum position
Valve Max Pos	90%	0...100%	Valve maximum position
Vfd Min Sp	10.0%	0.0...49.0 %	Setpoint for minimum percentage of Vfd Speed
Vfd Max Sp	100.0%	55.0...100.0%	Setpoint for maximum percentage of Vfd Speed
Valve Prop Gain	10.0	0.0...50.0	Proportional Gain of PID condensation controller
Valve Der Time	1s	0...180s	Derivative Time of PID condensation controller
Valve Int Time	600s	0...600s	Integral Time of PID condensation controller
Vfd Manual Speed	20.0%	0.0...100.0%	Setpoint for Vfd manual speed

4.2.5 Evaporator

This page contains basics settings for condensation control described in section 5.3.

Setpoint/Sub-Menu	Default	Range	Description
Cool Setp Offs	1.5°C	1.0...7.0°C	Offset on the cool setpoint to regulate the three way valve
Valve Type	NC to Tower	NC to tower, NO to Tower	Type of three way valve to tower
Min Valve Open	0.0%	0.0...60.0%	Valve minimum position
Max Valve Open	95.0%	50.0...100.0%	Valve maximum position
Kp	1	0.1...100	Proportional Gain of PID valve controller
Ti	2.0min	1.0...60.0min	Derivative Time of PID valve controller
Td	2.0min	1.0...60.0min	Integral Time of PID valve controller

4.2.6 Master/Slave

All data and parameters available in this sub-menus are related to the Master Slave function. Refer to Master Slave manual for more details.

Setpoint/Sub-Menu	Default	Range	Description
Data	▶	-	Submenu Data. This link is available only on the Master unit
Options	▶	-	Submenu Options. This link is available only on the Master unit
Thermostat Ctrl	▶	-	Submenu Thermostat Ctrl. This link is available only on the Master unit
Timers	▶	-	Submenu Timers. This link is available only on the Master unit
Standby Chiller	▶	-	Submenu Standby Chiller. This link is available only on the Master unit
Disconnect Unit	No	No, Yes	Parameter to disconnect the unit by the Master Slave system. When this parameter is set to Yes the unit follows all local settings.

4.2.6.1 Data

In this menu are collected all main data related to Master Slave function.

Setpoint/Sub-Menu	Default	Range	Description
Next On=	-	-, Master, Slave 1, Slave 2, Slave 3	Display next chiller that will be starts
Next Off=	-	-, Master, Slave 1, Slave 2, Slave 3	Display next chiller that will be stopped
Standby=	-	-, Master, Slave 1, Slave 2, Slave 3	Display the actual standby chiller
Switch Date	-	dd/mm/yyyy	Display the day in which the standby chiller will be cycled
Switch Time	-	hh:mm:ss	Display at which time of the switch day the standby chiller will be cycled
Plant Load=	-	0%...100%	Display the actual plant load
Avg EWT	-	-	Display the actual average entering water temperature value
Common EWT	-	-	Display the actual common entering water temperature value
Mst State=	-	Off, On, Alarm, Comm Err	Display the actual state of the Master
SI1 State=	-	Off, On, Alarm, Comm Err	Display the actual state of the Slave 1
SI2 State=	-	Off, On, Alarm, Comm Err	Display the actual state of the Slave 2
SI3 State=	-	Off, On, Alarm, Comm Err	Display the actual state of the Slave 3
Mst Standalone=	-	No, Yes	Display if the standalone mode if active on the Master
SI1 Standalone	-	No, Yes	Display if the standalone mode if active on the Slave 1
SI2 Standalone	-	No, Yes	Display if the standalone mode if active on the Slave 2
SI3 Standalone	-	No, Yes	Display if the standalone mode if active on the Slave 3
Mst Load=	-	0%...100%	Display the actual load of the Master
SI1 Load=	-	0%...100%	Display the actual load of the Slave 1
SI2 Load=	-	0%...100%	Display the actual load of the Slave 2
SI3 Load=	-	0%...100%	Display the actual load of the Slave 3
Mst LWT=	-	-	Display the Master leaving water temperature
SI1 LWT=	-	-	Display the Slave1 leaving water temperature
SI2 LWT=	-	-	Display the Slave2 leaving water temperature
SI3 LWT=	-	-	Display the Slave3 leaving water temperature
Mst EWT=	-	-	Display the Master entering water temperature
SI1 EWT=	-	-	Display the Slave1 entering water temperature
SI2 EWT=	-	-	Display the Slave2 entering water temperature
SI3 EWT=	-	-	Display the Slave3 entering water temperature
Mst Hrs=	-	-	Master running hours
SI1 Hrs=	-	-	Slave 1 running hours
SI2 Hrs=	-	-	Slave 2 running hours
SI3 Hrs=	-	-	Slave 3 running hours
Mst Starts=	-	-	Master number of starts
SI1 Starts=	-	-	Slave 1 number of starts
SI2 Starts=	-	-	Slave 2 number of starts
SI3 Starts=	-	-	Slave 3 number of starts

4.2.6.2 Options

This menu allows to set main parameter of Master Slave function

Setpoint/Sub-Menu	Default	Range	Description
Master Priority=	1	1...4	Start Up / Shut Down priority of the chiller Master Priority = 1 → highest priority Priority = 4 → lowest priority
Slave 1 Priority=	1	1...4	Start Up / Shut Down priority of the chiller Slave 1 Priority = 1 → highest priority Priority = 4 → lowest priority
Slave 2 Priority=	1	1...4	Start Up / Shut Down priority of the chiller Slave 2. Priority = 1 → highest priority Priority = 4 → lowest priority This menu is visible only if the parameter M/S Num Of Unit has been configured at least with value 3
Slave 3 Priority=	1	1...4	Start Up / Shut Down priority of the chiller Slave 3. Priority = 1 → highest priority Priority = 4 → lowest priority This menu is visible only if the parameter M/S Num Of Unit has been configured at least with value 4
Master Enable=	Enable	Enable Disable	This parameter allows to enable or disable locally the Master Chiller
Control Mode=	Complete	Partial Complete	Parameter to select the Partial or Complete control mode Partial → On/Off control Complete → On/Off + Capacity control
Control Tmp=	Leaving	Entering Leaving	Parameter to define the controlled temperature Entering - Thermoregulations is based on the Average Entering Water Temperature (AEWT) Leaving - Thermoregulation is based on the Common Leaving Water Temperature (CLWT)

4.2.6.3 Thermostat Ctrl

This page resumes all thermostat control parameter of Master Slave.

Setpoint/Sub-Menu	Default	Range	Description
Stage Up DT=	2.7°C	0.5...5.0°C	Offset respect the active setpoint for the unit startup.
Stage Dn DT =	1.5°C	0.5...5.0°C	Offset respect the active setpoint for the unit shutdown.
Dead Band =	0.2	0.1 - Min(Stage UP DT, Stage Dn DT)	Dead Band respect the active setpoint within which the load/unload command are no longer generated
Threshold=	60%	30...100%	Threshold of load that have to reach all units running before start of a new chiller
Stage Up Time=	5min	0min...20min	Minimum time between the start of two chillers
Stage Dn Time=	5min	0min...20min	Minimum time between the stop of two chillers
Min Evap Tmp=	4.0	-18...30°C	Minimum Evaporator leaving water temperature

4.2.6.4 Timers

Setpoint/Sub-Menu	Default	Range	Description
Stage Up Timer=	-	-	Current delay for new chiller stage up
Stage Dn Timer=	-	-	Current delay for new chiller stage down
Clear Timers=	Off	Off Reset	This command, visible only with service password, can be used to reset the Stage Up/Dn Timer.

4.2.6.5 Standby Chiller

This menu allows to configure the standby chiller

Setpoint/Sub-Menu	Default	Range	Description
Standby Chiller=	No	No, Auto, Master, Slave 1, Slave 2, Slave 3	Standby chiller selection
Cycling Type=	Time	Run Hours, Sequence	Cycling type of standby chiller if previous parameter Standby Chiller is set as Auto
Interval Time=	7 Days	1...365	Define the interval time (expressed in day) for the cycling of standby chiller
Switch Time=	00:00:00	00:00:00...23:59:59	Define the time within the day when will be performed the switch of the standby chiller
Tmp Cmp=	No	No, Yes	Enabling of Temperature Compensation function
Tmp Comp Time=	120 min	0...600	Time constant of Temperature Compensation function
Standby Reset=	Off	Off, Reset	Parameter to reset standby chiller cycling timer

4.2.7 Rapid Restart

This page shows if the function Rapid Restart is enabled by external contact and it allows to define the maximum black out time in order to recover quickly the unit load.

Setpoint/Sub-Menu	Default	Range	Description
Rapid Restart=	Disable	Enable, Disable	Feature enable if Rapid Restart is installed
Pwr Off Time=	60s	-	Maximum black out time to enable Rapid Restart

4.2.8 Date/Time

This page will allow to adjust the time and date in the UC. This time and date will be used in the alarm log and to enable and disable the Quiet Mode. Additionally it's also possible to set the starting and ending date for the DayLight Saving time (DLS) if used. Quiet Mode is a feature that is used to reduce the chiller noise. This is done by applying the maximum setpoint reset to the cooling setpoint and increasing the condenser temperature target by an adjustable offset.

Setpoint/Sub-Menu	Default	Range	Description
Actual Time=	12:00:00		Set the time
Actual Date=	01/01/2014		Set the date
UTC Diff=	-60min		Difference with UTC
DLS Enable=	Yes	No, Yes	Enable DayLight Saving time
DLS Strt Month=	Mar		DayLight Saving time start month
DLS Strt Week=	2ndWeek		DayLight Saving time start week
DLS End Month=	Nov	NA, Jan...Dec	DayLight Saving time end month
DLS End Week=	1stWeek	1 st ...5 th week	DayLight Saving time end week

On board real time clock settings are maintained thanks to a battery mounted on the controller. Make sure that the battery is replaced regularly each 2 years (see section 3.5).

4.2.9 Scheduler

This page allows to program the time scheduler

Setpoint/Sub-Menu	Default	Range	Description
State	Off	Off, On Setpoint 1, On Setpoint 2	Actual state provided by the time scheduler
Monday	▶	-	Link to Monday scheduler programming page
Tuesday	▶	-	Link to Tuesday scheduler programming page
Wednesday	▶	-	Link to Wednesday scheduler programming page
Thursday	▶	-	Link to Thursday scheduler programming page
Friday	▶	-	Link to Friday scheduler programming page
Saturday	▶	-	Link to Saturday scheduler programming page
Sunday	▶	-	Link to Sunday scheduler programming page

Table below reports the menu used to program daily time slots. Six time slots can be programmed by the user.

Setpoint/Sub-Menu	Default	Range	Description
Time 1	*. *	0:00..23:59	Define the starting time of 1 st time slot
Value 1	Off	Off, On Setpoint 1, On Setpoint 2	Define the unit state during 1 st time slot
Time 2	*. *	0:00..23:59	Define the starting time of 2 nd time slot
Value 2	Off	Off, On Setpoint 1, On Setpoint 2	Define the unit state during 2 nd time slot
Time 3	*. *	0:00..23:59	Define the starting time of 3 rd time slot
Value 3	Off	Off, On Setpoint 1, On Setpoint 2	Define the unit state during 3 rd time slot
Time 4	*. *	0:00..23:59	Define the starting time of 4 th time slot
Value 4	Off	Off, On Setpoint 1, On Setpoint 2	Define the unit state during 4 th time slot
Time 5	*. *	0:00..23:59	Define the starting time of 5 th time slot
Value 5	Off	Off, On Setpoint 1, On Setpoint 2	Define the unit state during 5 th time slot
Time 6	*. *	0:00..23:59	Define the starting time of 6 th time slot
Value 6	Off	Off, On Setpoint 1, On Setpoint 2	Define the unit state during 6 th time slot

4.2.10 Power Conservation

This page resumes all the settings that allows chiller capacity limitations. Further explanations of the setpoint reset options can be found in the chapter 7.1.

Setpoint/Sub-Menu	Default	Range	Description
Unit Capacity=	100.0%		
Demand Lim En=	Disable	Disable, Enable	Demand Limit Enable
Demand Limit=	100.0%		Demand Limit Mode - Active demand limitation
Unit Current=	100.0A		Current Limit Mode (optional) - Unit current reading
Current Limit=	800A		Current Limit Mode (optional) - Active Current limit
Flex Current Lm=	Disable	Disable, Enable	Flexible Current Limit Enable

Current Lim Sp=	800A	0...2000A	Current Limit Mode Current limit setpoint
Setpoint Reset=	None	None, 4-20mA, Return	Setpoint Reset Type
Max Reset=	5.0°C	0.0...10.0°C	Setpoint Reset Mode - Max Reset of water temp. setpoint
Start Reset DT=	5.0°C	0.0...10.0°C	Setpoint Reset Mode - Evaporator DT at which no reset is applied
Softload En=	Disable	Disable, Enable	Soft Load Mode Enable
Softload Ramp=	20min	1...60min	Soft Load Mode - Duration of the Softload ramp
Starting Cap=	40.0%	20.0...100.0%	Soft Load Mode - Starting capacity limit for Softload

4.2.11 Controller IP setup

The MicroTech controller has an embedded web server showing a replica of the onboard HMI screens. To access to this additional web HMI can be required to adjust the IP settings to match the settings of the local network. This can be done in this page. Please contact your IT department for further information on how to set the following setpoints.

To activate the new settings a reboot of the controller is required, this can be done with the Apply Changes setpoint.

The controller also supports DHCP, in this case the name of the controller must be used.

Setpoint/Sub-Menu	Default	Range	Description
Apply Changes=	No	No, Yes	When Yes, it save changes made on settings and reboot the controller
DHCP=	Off	Off, On	When On, Enable DHCP to automatically obtain an IP address
Act IP=	-		Active IP address
Act Msk=	-		Active Subnet mask
Act Gwy=	-		Active Gateway
Gvn IP=	-		Given IP address (it will become the active)
Gvn Msk=	-		Given Subnet mask
Gvn Gwy=	-		Given Gateway
PrimDNS	-		Primary DNS
SecDNS	-		Secondary DNS
Name	-		Controller Name
MAC	-		Controller MAC Address

Check with IT Department on how to set these properties in order to connect the Micro Tech to the local network.

4.2.12 Daikin on Site

This menu allows to the user to enable the communication with Daikin cloud DoS (Daikin on Site). This option requires that the controller has access to internet. Please contact your service organization for more details.

Setpoint/Sub-Menu	Default	Range	Description
Comm Start=	Off	Off, Start	Command to enable the communication
Comm State=	-	- IPErr Init InitReg Reg RegErr Descr Connected	Communication state. The communication is established only if this parameter displays Connected
Cntrlr ID=	-	-	Controller ID. This parameter is helpful to identify the specific controller in DoS
Remote Update=	Disable	Disable, Enable	Allow the application update from Daikin on Site.

4.2.13 Software Options

For the model on this manual, the possibility to employ a set of software options has been added to the functionality of the chiller, in according with the new MicroTech installed on the Unit. The Software Options do not require any additional hardware and regard communication channels and the new energy functionalities. During the commissioning the machine is delivered with the Option Set chosen by the customer; the Password inserted is permanent and depends on the Serial Machine Number and the Option Set selected. In order to check the current Option Set:

Main Menu Commission Unit → Configuration → OptionSW



Parameter	Description
Password	Writable by Interface/Web Interface
Option Name	Option Name
Option Status	Option is activated. Option is not activated

The Current Password inserted activates the selected options.

4.2.13.1 Changing the Password for buying new Software Options

The Option Set and the Password are updated in the Factory. If the customer wants to change its Option Set, he needs to contact the Daikin Personnel and asks for a new password.

As soon as the new password is communicated, the follow steps allow the customer to change the Option Set by himself:

1. Wait for the circuits are both OFF, then, from the Main Page, Main Menu → Unit Enable → Unit → Disable
2. Go to Main Menu → Commission Unit → Configuration → Software Options
3. Select the Options to Activate
4. Insert the Password
5. Wait for the States of the selected options going to On
6. Apply Changes → Yes (it will reboot the controller)

The Password is changeable only if the machine is working in safe conditions: both the circuits are in the State Off.

4.2.13.2 Inserting the Password in a Spare Controller

If the Controller is broken and/or it needs to be replaced for any reason, the customer needs to configure the Option Set with a new Password.

If this replacement is scheduled, the customer can ask to Daikin Personnel for a new Password and repeat the steps in chapter 4.4.1.

If there is no enough time to ask for a Password to Daikin Personnel (ex. an expected failure of the controller), a set of Free Limited Password is provided, in order not to interrupt the machine's working.

These Passwords are free and visualized in:

Main Menu→Commission Unit→Configuration→Software Options→Temporary Passwords

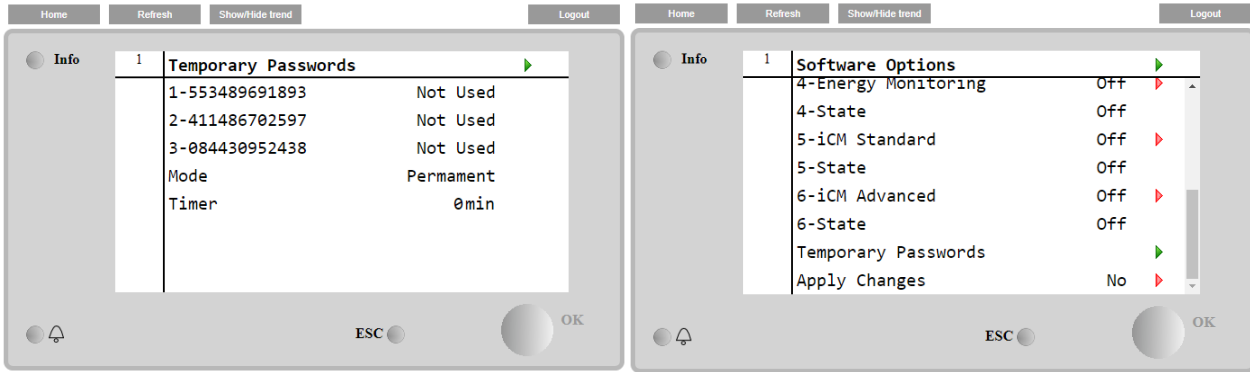

Their Use is limited up to three months:

- 553489691893 –3 Months Duration
- 411486702597 –1 Month Duration
- 084430952438 – 1 Month Duration

Parameter	Specific Status	Description
553489691893		Activate the Option Set for 3 Months.
411486702597		Activate the Option Set for 1 Month.
084430952438		Activate the Option Set for 1 Month.
Mode	Permanent	A permanent Password is inserted. Option set can be used for unlimited time.
Temporary		A temporary Password is inserted. Option set can be used depending on the password inserted.
Timer		Last duration of the Option Set activated. Enabled only if the mode is Temporary

The Password is changeable only if the machine is working in safe conditions: both the circuits are in the State Off

4.2.13.3 Modbus MSTP Software Option

When the software option “Modbus MSTP” is activated and the controller is restarted, the communication protocol settings page can be accessed via the path:

Main Menu→Commission Unit→SW Modbus MSTP

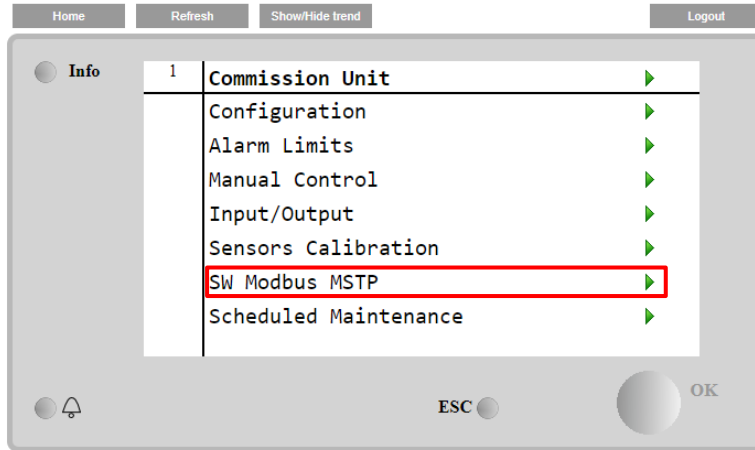

The values that can be set are the same as those found on the Modbus MSTP option page with the relative driver, and depend on the specific system where the unit is installed.

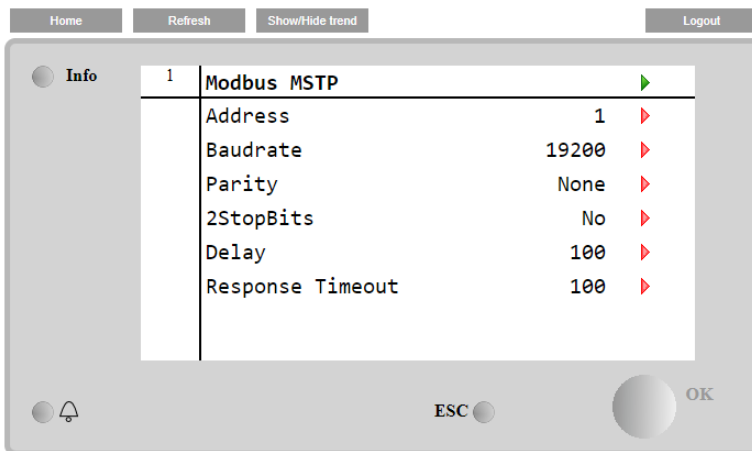

To establish the connection, the RS485 port to use is the one on the T14 terminal of the MT4 controller.

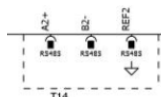

4.2.13.4 BACNET MSTP

When the software option "BACNet MSTP" is activated and the controller is restarted, the communication protocol settings page can be accessed via the path:

Main Menu→Commission Unit→SW BACNet MSTP

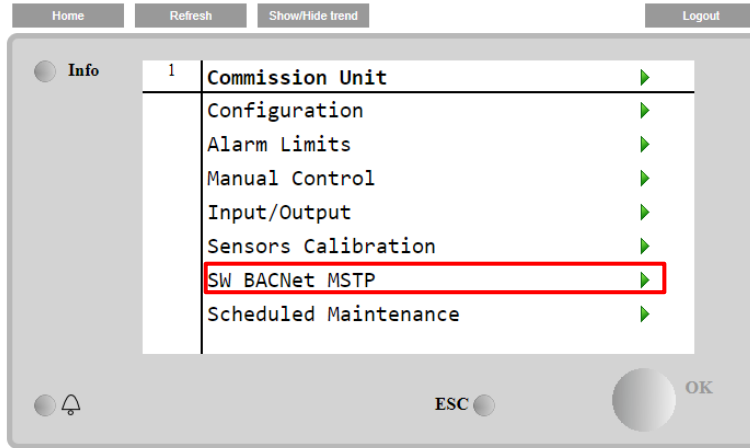

The values that can be set are the same as those found on the BACNet MSTP option page with the relative driver, and depend on the specific system where the unit is installed.

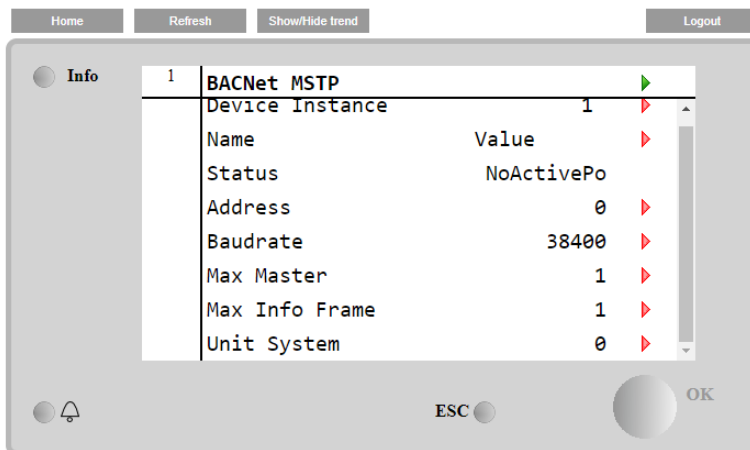

To establish the connection, the RS485 port to use is the one on the T14 terminal of the MT4 controller.

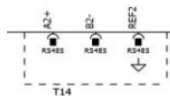

4.2.13.5 BACNET IP

When the software option “BACNet IP” is activated and the controller is restarted, the communication protocol settings page can be accessed via the path:

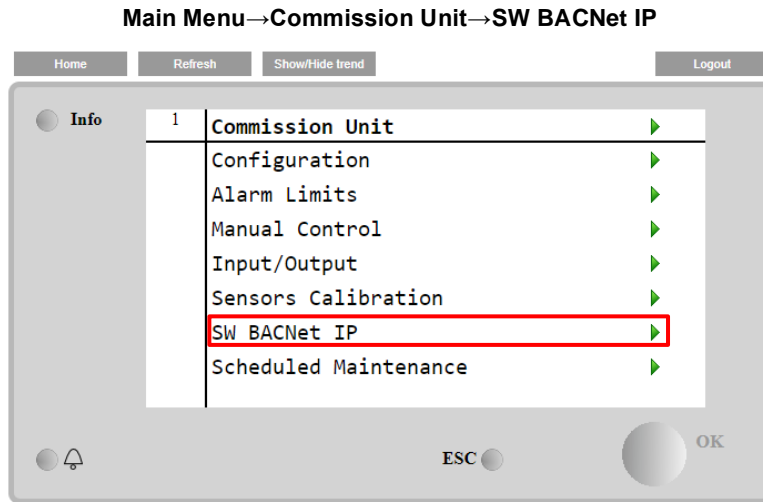

The values that can be set are the same as those found on the BACNet MSTP option page with the relative driver, and depend on the specific system where the unit is installed.

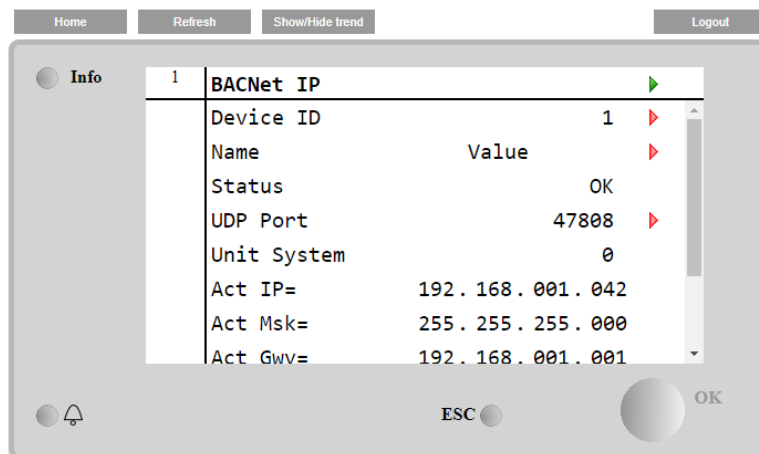

The port for LAN connection to be used for BACNet IP communication is the T-IP Ethernet port, the same one used for remote control of the controller on the PC.

4.2.14 Menu Password

It is possible to keep the User level always active to avoid to enter the User password. To do this the Password Disable setpoint shall be set to On.

Setpoint/Sub-Menu	Default	Range	Description
Pwd Disable	Off	Off, On	Menu for Circuit #1

4.3 Active Setpoint

This link jumps to the page "Tmp Setpoint". This page resumes all chiller water temperature setpoints (limits and active setpoint will depend on the operating mode selected).

Setpoint/Sub-Menu	Default	Range	Description
Cool LWT 1=	7.0°C	4.0...15.0°C (cool mode) -8.0...15.0°C (cool w/ glycol mode)	Primary cooling setpoint
Cool LWT 2=	7.0°C	4.0...15.0°C (cool mode) -8.0...15.0°C (cool w/ glycol mode)	Secondary cooling setpoint (see 3.6.3)
Heat LWT 1=	35.0°C	Compressor dependent	Primary Heating setpoint
Heat LWT 2=	35.0°C	Compressor dependent	Secondary Heating setpoint
Max LWT=	15.0°C	10.0...20.0°C	High limit for Cool LWT1 and Cool LWT2
Min LWT=	-8.0°C	-15.0...-8.0°C	Low limit for Cool LWT1 and Cool LWT2

4.4 Evaporator LWT

This link jumps to the page "Temperatures". This page resumes all the relevant water temperatures.

Setpoint/Sub-Menu	Default	Range	Description
Evap LWT=	-273.1°C	-	Controlled water temperature
Evap EWT=	-273.1°C	-	Return water temperature
Cond LWT=	-273.1°C	-	Condenser leaving water temperature
Cond EWT=	-273.1°C	-	Condenser entering water temperature
Evap Delta T=	-273.1°C	-	Delta T across Evaporator
Cond Delta T=	-273.1°C	-	Delta T across Condenser
PullDn Rate	N/A	-	Rate of decrease of the controlled temperature
Ev LWT Slope	0.0°C/min	-	Rate of decrease of the controlled temperature
Cd LWT Slope	0.0°C/min	-	Rate of decrease of the condenser leaving water temperature
Act Slope Lim.	1.7 °C/min	-	Maximum slopes
Common LWT=	-273.1°C	-	Master Slave Common supply water temperature

4.5 Condenser LWT

This link jumps to the page "Temperatures". See section 4.4 for detailed page content.

4.6 Unit Capacity

This page displays the actual unit and circuit capacity

Setpoint/Sub-Menu	Default	Range	Description
Unit=	-	-	Actual unit capacity
Circuit #1=	-	-	Actual circuit 1 capacity
Circuit #2=	-	-	Actual circuit 2 capacity

4.7 Unit Mode

This item shows the present Operating Mode and jumps to the page for unit mode selection.

Setpoint/Sub-Menu	Default		Description
Available Modes=	Cool	Cool, Cool w/ Glycol, Heat/Cool, Heat/Cool w/Glycol, Pursuit, Test	Available operating modes

Depending on selected mode among availables, the Unit Mode on the main menu will assume the corresponding value according to the following table:

Available mode selected		
	C/H Switch = Cool	C/H Switch = Heat
Cool	Cool	N/A
Cool w/ Glycol		
Cool/Ice w/ Glycol		
Ice w/ Glycol	Ice	Heat
Heat/Cool	Cool	
Heat/Cool w/Glycol		
Heat/Ice w/Glycol	Ice	
Pursuit	Pursuit	
Test	Test	

4.8 Unit Enable

This page allows to enable or disable unit and circuits. For the unit it also possible enable the operation with time scheduler, while for circuit it is possible to enable the test mode.

Setpoint/Sub-Menu	Default	Range	Description
Unit	Enable	Enable, Disable, Scheduler	Unit enable command
Compressor #1	Enable	Enable, Disable, Test	Compressor #1 enable command
Compressor #2	Enable	Enable, Disable, Test	Compressor #2 enable command
Compressor #3	Enable	Enable, Disable, Test	Compressor #3 enable command

4.9 Timers

This page indicates the remaining cycle timers for each circuit and the remaining staging timers. When the cycle timers are active any new start of a compressor is inhibited.

Setpoint/Sub-Menu	Default	Range	Description
C1 Cycle Tm Left=	0s	-	Compressor 1 cycle timer
C2 Cycle Tm Left=	0s	-	Compressor 2 cycle timer
C3 Cycle Tm Left=	0s	-	Compressor 3 cycle timer
C1 Cycle Tmr Clr=	Off	Off, On	Clear compressor 1 cycle timer
C2 Cycle Tmr Clr=	Off	Off, On	Clear compressor 2 cycle timer
C3 Cycle Tmr Clr=	Off	Off, On	Clear compressor 3 cycle timer
Stg Up Dly Rem=	0s	-	Remaining delay to next compressor start
Stg Dn Dly Rem=	0s	-	Remaining delay to next compressor stop
Clr Stg Delays=	Off	Off, On	Clear remaining delays to next compressor start/stop

4.10 Alarms

This link jumps to the same page accessible with the Bell button. Each of the items represents a link to a page with different information. The information shown depends on the abnormal operating condition that caused the activation of unit, circuit or compressor safeties. A detailed description of the alarms and how to handle will be discussed in the section 6.

Setpoint/Sub-Menu	Default	Description
Alarm Active	▶	List of the active alarms
Alarm Log	▶	History of all the alarms and acknowledges
Event Log	▶	List of the events
Alarm Snapshot	▶	List of alarm snapshots with all the relevant data recorded at time the alarm occurred.

4.11 Commission Unit

Setpoint/Sub-Menu	Default	Range	Description
Alarms Limits	▶	-	Submenu for alarm limits definition
Calibrate Sensors	▶	-	Submenus for Unit and Circuit sensor calibration
Manual Control	▶	-	Submenus for Unit and Circuit manual control
Scheduled Maintenance	▶	-	Submenu for scheduled maintenance

4.11.1 Alarm Limits

This page contains all alarm limits, including low pressure alarm prevention thresholds. In order to ensure proper operation they have to be set manually according to the specific application.

Setpoint/Sub-Menu	Default	Range	Description
Low Press Hold=	200.0kPa	170.0...310.0 kPa	Low pressure safety limit to stop capacity increase (R134a)
Low Press Unld=	190.0kPa	170.0...250.0 kPa	Low pressure alarm prevention (R134a)
Low Press Hold=	122.0kPa	-27.0...204.0 kPa	Low pressure safety limit to stop capacity increase (VZ with R1234ze)
Low Press Unld=	114.0kPa	-27.0...159.0 kPa	Low pressure alarm prevention (VZ with R1234ze)
Low Press Hold=	NA	-27.0... 310.0	Low pressure safety limit to stop capacity increase (TZ with R1234ze)
Low Press Unld=	NA	-27.0... 310.0	Low pressure alarm prevention (TZ with R1234ze)
Hi Cond Pr Dly=	5s		Delay on the High pressure alarm from transducer
Evap Water Frz	2.2°C	2.0...6.0°C	Evaporator Water Freeze Limit
Cond Water Frz	2.2°C	2.0...6.0°C	Condenser Water Freeze Limit
Water Flw Proof=	15s	5...15s	Flow proof delay
Water Rec Timeout=	3min	1...10min	Recirculating timeout before the alarm is raised
Low DSH Limit=	12.0°C		Minimum acceptable discharge superheat

4.11.2 Calibrate Sensors

Setpoint/Sub-Menu	Default	Range	Description
Unit	▶	-	Submenu for Unit calibrate sensor
Circuit #1	▶	-	Submenu for Circuit 1 calibrate sensor
Circuit #2	▶	-	Submenu for Circuit 2 calibrate sensor

4.11.2.1 Unit Calibrate Sensors

This page allows a proper calibration of the unit sensors

Setpoint/Sub-Menu	Default	Range	Description
Evap LWT=	7.0°C		Evaporator LWT current reading (includes the offset)
Evp LWT Offset=	0.0°C		Evaporator LWT calibration
Evap EWT=	12.0°C		Evaporator EWT current reading (includes the offset)
Evp EWT Offset=	0.0°C		Evaporator EWT calibration
Evap Pressure=			Evaporator Refrigerant Pressure
Evp Pr Offset=	0.0kPa		Evaporator Refrigerant Pressure Offset
Cond Pressure=			Condenser Refrigerant Pressure
Cnd Pr Offset=	0.0kPa		Condenser Refrigerant Pressure Offset
Common LWT	8°C		Common LWT current reading Includes the offset
Comm LWT Offset=	0.0°C		Common LWT calibration

4.11.2.2 Compressor Calibrate Sensors

This page allows to adjust the sensors and transducers readings.

Setpoint/Sub-Menu	Default	Range	Description
Suction Temp=			Suction Temperature current reading (includes the offset)
Suction Offset=	0.0°C		Suction Temperature offset
Econ Pressure=			Economizer Pressure current reading (includes the offset)
Eco Pr Offset=	0.0kPa		Economizer Pressure offset
Econ Temp=			Economizer Temperature current reading (includes the offset)
Eco Tmp Offset=	0.0°C		Economizer Temperature offset



Calibrations of the Evaporator Pressure and Suction Temperature are mandatory for the applications with negative water temperature setpoints. These calibrations have to be performed with proper gauge and thermometer.

An improper calibration of the two instruments may generate limitation of the operations, alarms and even damages to components.

4.11.3 Scheduled Maintenance

This page may contains the contact number of the Service organization taking care of this unit and the next maintenance visit schedule.

Setpoint/Sub-Menu	Default	Range	Description
Next Maint=	Jan 2015		Schedule date for next maintenance
Support Reference=	999-999-999		Reference number or email of Service Org

4.12 About this Chiller

This page resumes all the information needed to identify the unit and the current software version installed. These information may be required in case of alarms or unit failure

Setpoint/Sub-Menu	Default	Range	Description
Model			Unit model and code name
Unit S/N=			Unit serial number
OV14-00001			
BSP Ver=			Firmware version
App Ver=			Software version

5 WORKING WITH THIS UNIT

This section contains a guide on how to deal with the everyday usage of the unit. Next sections describe how to perform routine tasks on the unit, such as:

- Unit Setup
- Unit/Circuit start-up
- Alarm handling
- BMS Control
- Battery replacement

5.1 Unit Setup

Before starting up the unit, some basic settings need to be set by the customer according to the application.

- Control Source (4.2.2)
- Available Modes (4.7)
- Temperature Settings (5.1.3)
- Alarm Settings (4.11.1)
- Pump Settings (5.1.3.3)
- Power Conservation (4.2.10)
- Date/Time (4.2.8)
- Scheduler (4.2.9)

5.1.1 Control Source

This function allows to select which source should be used for unit control. The following sources are available:

Local	Unit is enabled by local switches placed into the switchbox, chiller mode (cool, cool w/glycol, ice), LWT setpoint and capacity limit are determined by local settings in the HMI.
Network	Unit is enable by a remote switch, chiller mode, LWT setpoint and capacity limit are determined by an external BMS. This function requires: Remote enable connection to a BMS (unit on/off switch must be in remote) Communication module and its connection to a BMS.

More parameters about network control can be found in 4.2.2.

5.1.2 Available Mode Setting

The following operating modes can be selected through the Available modes menu 4.7:

Mode	Description	Unit Range
Cool	Set if chilled water temperature up to 4°C is required. No glycol is generally needed in the water circuit, unless ambient temperature may reach low values.	A/C and W/C
Cool w/Glycol	Set if chilled water temperature below 4°C is required. This operation requires proper glycol/water mixture in the evaporator water circuit.	A/C and W/C
Cool/Ice w/Glycol	Set in case a dual cool/ice mode is required. This setting implies an operation with double setpoint which is activated through a customer supplied switch, according to the following logic: Switch OFF: The chiller will work in cooling mode with the Cool LWT 1 being as the Active Setpoint. Switch ON: The chiller will work in ice mode with the Ice LWT as the Active Setpoint.	A/C and W/C
Ice w/Glycol	Set if ice storage is required. The application requires the compressors to operate at full load until the ice bank is completed, and then to stop for at least 12 hours. In this mode the compressor(s) will not operate at part load, but will work only in on/off mode.	A/C and W/C



The following modes allow to switch the unit between heat mode and one of the previous cool mode (Cool, Cool w/Glycol, Ice)

Heat/Cool	Set in case a dual cool/heat mode is required. This setting implies an operation with double functioning which is activated through the Cool/Heat switch on the electric box: <ul style="list-style-type: none"> • Switch COOL: The chiller will work in cooling mode with the Cool LWT 1 as the Active Setpoint. • Switch HEAT: The chiller will work in heat pump mode with the Heat LWT 1 as the Active Setpoint. 	W/C
Heat/Cool w/Glycol	Set in case a dual cool/heat mode is required. This setting implies an operation with double functioning which is activated through the Cool/Heat switch on the electric box: <ul style="list-style-type: none"> • Switch COOL: The chiller will work in cooling mode with the Cool LWT 1 as the Active Setpoint. • Switch HEAT: The chiller will work in heat pump mode with the Heat LWT 1 as the Active Setpoint 	W/C
Heat/Ice w/Glycol	Set in case a dual cool/heat mode is required. This setting implies an operation with double functioning which is activated through the Cool/Heat switch on the electric box: <ul style="list-style-type: none"> • Switch ICE: The chiller will work in cooling mode with the Ice LWT as the Active Setpoint. • Switch HEAT: The chiller will work in heat pump mode with the Heat LWT 1 as the Active Setpoint. 	W/C
Pursuit	Set in case of double water control cool and contemporary heat. Evaporator leaving water temperature follows the Cool LWT 1 setpoint. Condenser leaving water temperature follows the Heat LWT 1 setpoint.	W/C

Mode	Description	Unit Range
Test	Enables the Manual Control of the unit. The manual test feature helps in debugging and checking the operational status of sensors and actuators. This feature is accessible only with the maintenance password in the main menu. To activate the test feature is required to disable the Unit from the Q0 switch and change the available mode to Test (see section 5.2.2).	A/C and W/C

It has to be noted that in case the selected mode cannot be managed by the unit, it will revert to Cool.

5.1.3 Temperature Settings

Purpose of the unit is to keep the evaporator leaving water temperature as close as possible to a pre-set value, called Active Setpoint. The Active Setpoint is calculated by the unit controller based on the following parameters:

- Available Modes
- Double setpoint input
- Scheduler state
- LWT Setpoint
- Setpoint Reset

Operation mode and LWT setpoint can also be set via network if the appropriate control source has been selected.

5.1.3.1 LWT Setpoint Setting

Setpoint range is limited according to the selected operating mode. The controller includes:

- two set points in cooling mode
- two set points in heating mode (W/C units only)
- one set point in ice mode

The above setpoints are activated according to Operating mode, Double Setpoint or Scheduler selection. If the Time Scheduler is enabled the Double Setpoint input state will be ignored by the controller.

The table below lists the LWT Setpoint being activated according to the operation mode, the double setpoint switch status and the scheduler state. The table also reports the defaults and the range allowed for each setpoint.

Operating Mode	Units	Double Input	Setpoint	Scheduler	LWT Setpoint	Default	Range
Cool	W/C	OFF		Off, On Setpoint 1	Cool LWT 1	7.0°C	4.0°C ÷ 15.0°C
		ON		On Setpoint 2	Cool LWT 2	7.0°C	4.0°C ÷ 15.0°C
Heat	W/C	OFF		Off, On Setpoint 1	Heat LWT 1	45.0°C	30.0°C ÷ 55.0°C(*)
		ON		On Setpoint 2	Heat LWT 2	45.0°C	30.0°C ÷ 55.0°C(*)

The LWT setpoint can be overridden in case the setpoint reset (for details see chapter 5.1.4.3).

5.1.3.2 Thermostat Control Settings

Thermostat control settings, allows to set up the response to temperature variations and the precision of the thermostat control. Default settings are valid for most applications, however site specific conditions may require adjustments in order to have a smooth and precise temperature control or a quicker response of the unit.

The control will start the first circuit if the controlled temperature is higher (Cool Mode) or lower (Heat Mode) than the active setpoint (AS) of at least a Start Up DT (SU) value. Once circuit capacity exceeds the *Hi Ld Stg Up* % another circuit is switched on. When controlled temperature is within the deadband (DB) error from the active setpoint (AS), unit capacity will not be changed.

If the leaving water temperature decreases below (Cool Mode) or rises above (Heat Mode) the active setpoint (AS), unit capacity is adjusted to keep it stable. A further decreasing (Cool Mode) or increasing (Heat Mode) of the controlled temperature of the Shut Down DT offset (SD) can cause circuit shutdown.

In the Shutdown area the whole unit is switched off. In particular, a compressor will be shut down if it is required to unload below the *Lt Ld Stg Dn* % capacity.

Loading and unloading speeds are calculated by a proprietary PID algorithm. However, maximum the rate of water temperature decrease can be limited through the parameter *Max Pulldn*.



Circuits are always started and stopped to guarantee the balancing of running hours and number or starts in multiple circuits units. This strategy optimizes the lifetime of compressors, inverters, capacitors and all the others circuit components.

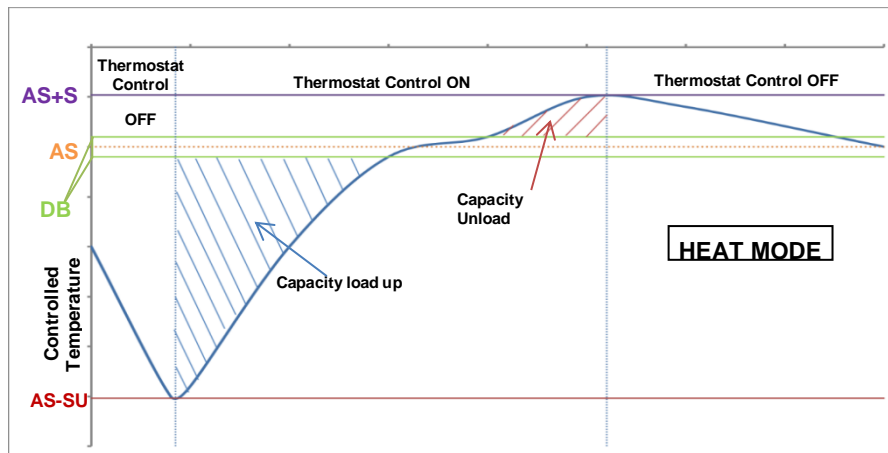
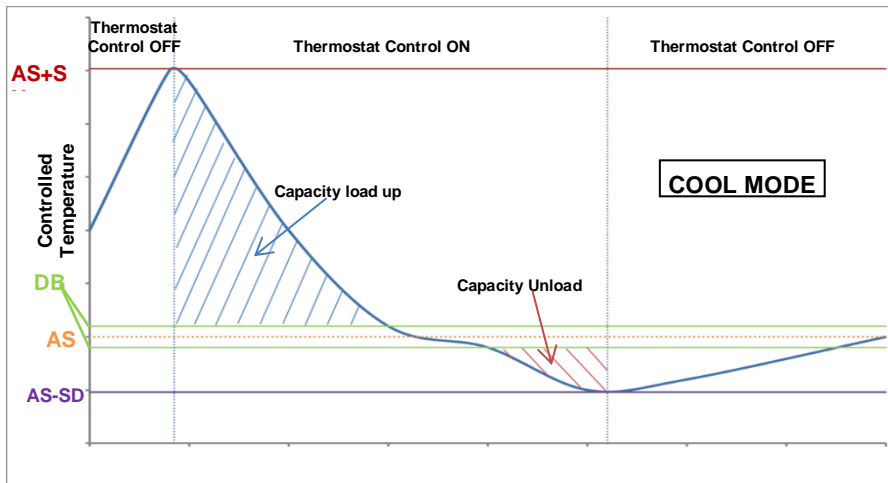

5.1.3.3 Pumps

The UC can manage one or two water pumps for both evaporator and condenser.

The following options are available to control the pump(s):

- #1 Only Set to this in case of single pump or twin pump with only #1 operational (f.e. in case of maintenance on #2)
- #2 Only Set to this in case of twin pump with only #2 operational (f.e. in case of maintenance on #1)
- Auto Set for automatic pump start management. At each chiller start, the pump with the least number of hours will be activated.
- #1 Primary Set to this in case of twin pump with #1 running and #2 as a backup
- #2 Primary Set to this in case of twin pump with #2 running and #1 as a backup

5.1.4 Power Conservation

5.1.4.1 Demand Limit

Demand limit function allows the unit to be limited to a specified maximum load. Capacity limit level is defined with an external 4-20 mA signal and linear relationship. 4 mA indicate maximum capacity available whereas 20 mA indicates minimum capacity available.

With demand limit function is not possible shutdown the unit but only unload it until minimum admissible capacity. Demand limit related setpoints available through this menu are listed in the table below.

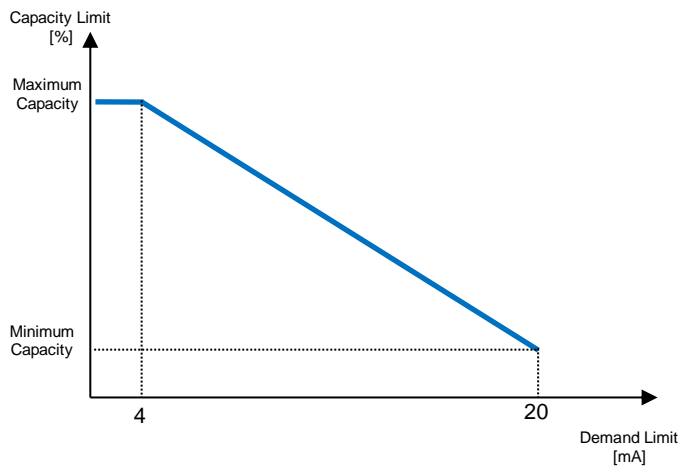

Parameter	Description
Unit Capacity	Displays current unit capacity
Demand Limit En	Enables demand limit
Demand Limit	Displays active demand limit

5.1.4.2 Current Limit (Optional)

Current limit function allows to control unit power consumption taking current drawn below a specific limit. Starting from the Current Limit Setpoint defined through the HMI or BAS communication, user can change the limit.

5.1.4.3 Setpoint Reset

The setpoint reset function overrides the chilled water temperature selected through the interface, when certain circumstances occur. This feature helps in reducing energy consumption optimizing comfort as well. Three different control strategies can be selected:

- Setpoint Reset by an external signal (4-20mA)
- Setpoint Reset by Evaporator ΔT (Return)

The following setpoints are available through this menu:

Parameter	Description
Setpoint Reset	Set the Setpoint Reset mode (None, 4-20 mA, Return, OAT)
Max Reset	Max Setpoint Reset (valid for all active modes)
Start Reset DT	Used on Setpoint Reset by Evaporator DT

5.1.4.4 Setpoint Reset by External 4-20 mA Signal

The active setpoint is calculated applying a correction based on an external 4-20mA signal. 4 mA corresponds to 0°C correction, while 20 mA corresponds to a correction of the active setpoint as set in Max Reset (MR).

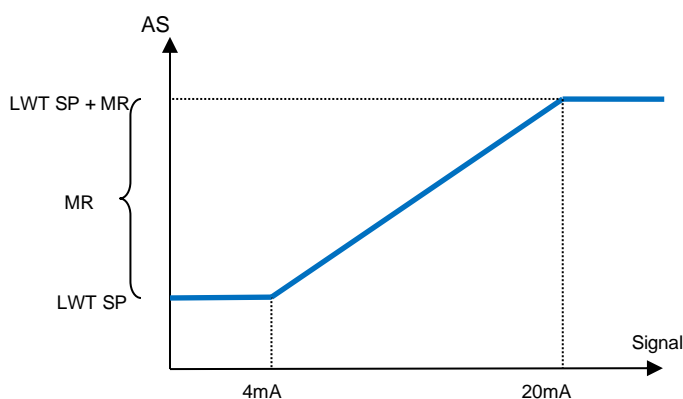

Parameter	Default	Range
Max Reset (MR)	5.0°C	0.0°C ÷ 10.0°C
Active Setpoint (AS)		
LWT Setpoint (LWT SP)		Cool/Ice LWT
Signal		4-20mA External signal

5.1.4.5 Setpoint Reset by Evaporator Return Temperature

The active setpoint is calculated applying a correction that depends on the evaporator entering (return) water temperature. As evaporator ΔT becomes lower than the SR ΔT value, an offset to the LWT setpoint is increasingly applied, up to the MR value when the return temperature reaches the chilled water temperature.



The Return Reset may affect negatively the chiller operation when operated with variable flow. Avoid to use this strategy in case of inverter water flow control.

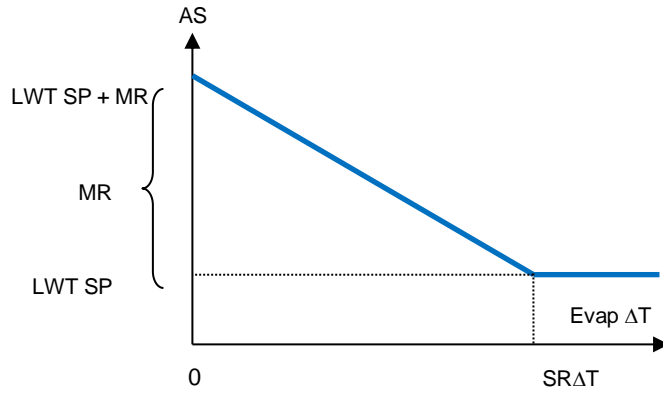

Parameter	Default	Range
Max Reset (MR)	5.0°C	0.0°C ÷ 10.0°C
Start Reset DT (SRΔT)	5.0°C	0.0°C ÷ 10.0°C
Active Setpoint (AS)		
LWT Target (LWT SP)		Cool/Ice LWT

5.1.4.6 Soft Load

Soft Loading is a configurable function used to ramp up the unit capacity over a given time period, usually used to influence building electrical demand by gradually loading the unit. The setpoints that control this function are:

Parameter	Description
Softload En	Enables soft loading
Softload Ramp	Duration of the soft load ramp
Starting Cap	Begin capacity limit. Unit will increase capacity from this value to 100% over the time specified by the Softload Ramp setpoint.

5.1.5 Date/Time

5.1.5.1 Date, Time and UTC Settings

See 0.

5.1.6 Scheduler

Unit On/Off can be managed automatically through the function Time Scheduler enabled when the parameter Unit Enable is set to Scheduler. For each day of the week user can define six time slots and choose for each time slot one of following mode:

Parameter	Description
Off	Unit Off
On Setpoint 1	Unit On and Cool LWT 1 is the active setpoint
On Setpoint 2	Unit On and Cool LWT 2 is the active setpoint

5.2 Unit Start-up

In this section, starting and stopping sequence of the unit will be described. status will be briefly described to allow a better understanding of what is going on into the chiller control.

5.2.1 Unit Status

One of the texts strings listed in the table below will inform, on the HMI, about the Unit Status.

Overall Status	Status text	Description
Off:	Keypad Disable	The Unit has been disabled by keypad. Check with your local maintenance if it can be enabled.
	Loc/Rem Switch	The Local/Remote enable switch is set to disable. Turn it to Local to enable the unit to start its starting sequence.
	BAS Disable	Unit is disabled by BAS/BMS system. Check with the BAS company how to start the unit.
	Master Disable	Unit is disabled by the Master Slave function
	Scheduler Disabled	Unit is disabled by the time scheduler.
	Unit Alarm	A unit alarm is active. Check the alarm list to see what is the active alarm inhibiting the unit to start and check if the alarm can be cleared. Refer to section 6. before proceeding.
	Test Mode	Unit mode set to Test. This mode is activated to check operability of onboard actuators and sensors. Check with the local maintenance if the Mode can be reverted to the one compatible with unit application (View/Set Unit – Set-Up – Available Modes).
	All Cir Disabled	No circuit is available to run. All circuits can be disabled by their individual enable switch or can be disabled by a component safety condition active or can be disabled by keypad or can be all in alarms. Check the individual circuit status for further details.
	Ice Mode Tmr	This status can be shown only if the unit can work in Ice Mode. The unit is off because the Ice setpoint has been satisfied. Unit will remain off until the Ice Timer has expired.

Overall Status	Status text	Description
	OAT Lockout (A/C units only)	The unit cannot run because the Outside Air Temperature is below the limit foreseen for the condenser temperature control system installed in this Unit. If the Unit has to run anyway check with your local maintenance how to proceed.
Auto		Unit is in Auto control. The pump is running and at least one compressor is running.
Auto:	Evap Recirc	Unit is running the evaporator pump to equalize the water temperature in the evaporator.
	Wait For Flow	Unit pump is running but the flow signal still indicate a lack of flow through the evaporator.
	Wait For Load	Unit is in standby because the thermostat control satisfied the active setpoint.
	Unit Cap Limit	Demand limit has been hit. Unit capacity will not further increase.
	Current Limit	Maximum current has been hit. Unit capacity will not further increase.
	Noise Reduction	Unit is running with the Quiet Mode activated. Active setpoint may differ from what has been set as cooling setpoint.
	Max Pulldn	Unit thermostat control is limiting the unit capacity because the water temperature is dropping at a rate that could exceed the active setpoint.
	Pumpdn	Unit is shutting down.

5.2.2 Prepare the unit to start

The unit starts only if all the enable setpoints/signals are active:

- Unit Switch Enable (signal) = Enable
- Keypad Enable (setpoint) = Enable
- BMS Enable (setpoint) = Enable

5.2.2.1 Unit Switch Enable

Each unit is equipped with a Main selector installed outside the front panel of the unit switchbox. As shown in the pictures below, for VZ units, two different positions can be selected: Local, Disable:

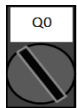

Local

With the Q0 switch in this position the unit is enabled. Pump will start if all other enable signals are set to enable and at least one compressor is available to run

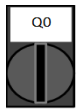

Disable

With the Q0 switch in this position the unit is disabled. Pump will not start in normal operational condition. Compressor are kept disabled independently from the status of the individual enable switches.

5.2.3 Keypad Enable

The Keypad enable setpoint is not accessible by user password level. If it is set to “Disable”, contact your local maintenance service to check if it can be changed to Enable.

5.2.3.1 BMS Enable

The last enable signal is coming through the high level interface, that is from a Building Management System. The unit can be enabled/disabled from a BMS connected to the UC using a communication protocol. In order to control the unit over the network, the Control Source setpoint must be turned in “Network” (default is Local) and Network En Sp must be “Enable” (4.2.2). If disabled, check with your BAS company how the chiller is operated.

5.3 Condensation Control

Condenser Entering Water Temperature is controlled in order to achieve best chiller efficiency within compressor envelope limits. To do this, application manages the outputs for the control of the following condensation devices:

- Tower fan #1...4 by mean of 4 on/off signals. Tower fan # state is on when Cond EWT is greater than the Cond EWT setpoint. Tower fan # state is off when Cond EWT is lower than Setpoint – Diff. The picture below represents an example of activation and deactivation sequence based on Cond EWT present value relation with set points and differentials listed in 4.2.4.

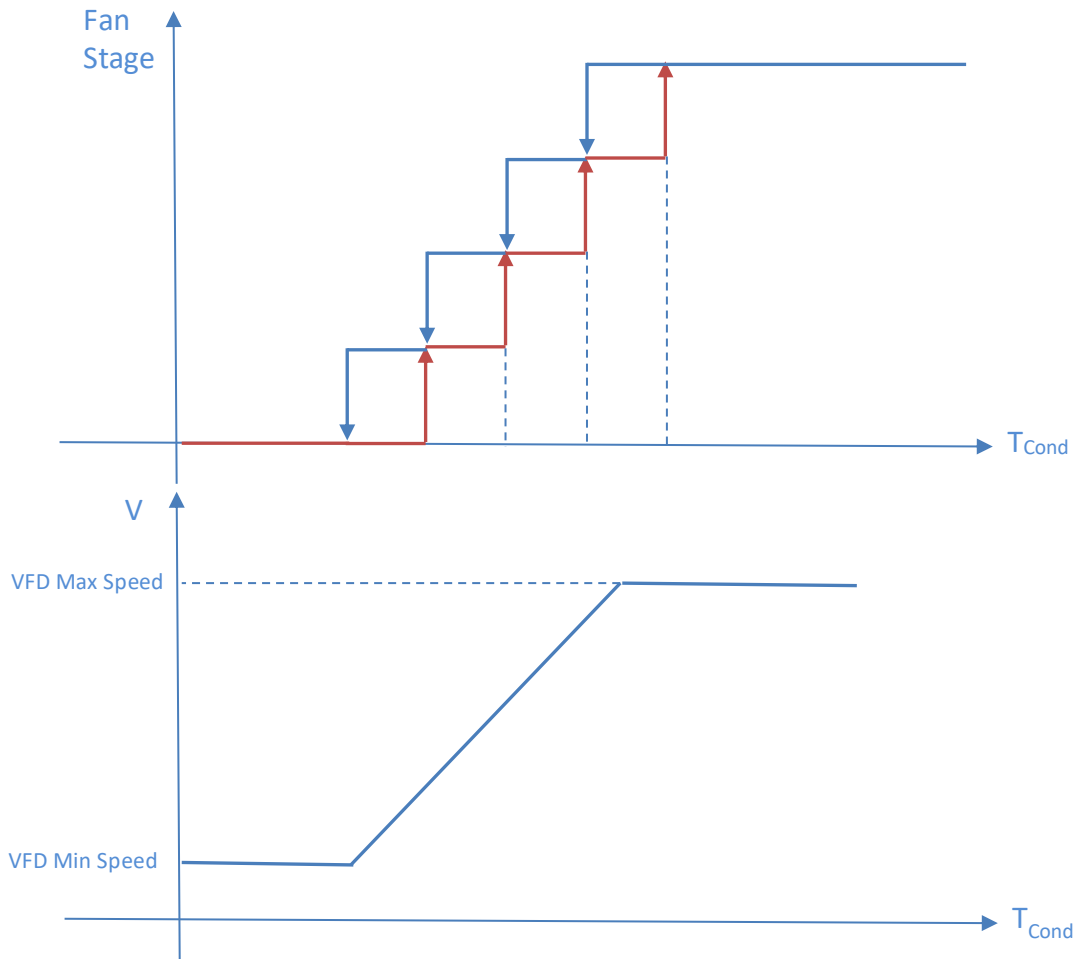

- 1 Vfd by mean of a modulating 0-10V signal generated through a PID controller. The following graph is an example of the modulating signal behavior in case of a PID control supposed to be purely proportional.

6 ALARMS AND TROUBLESHOOTING

The UC protects the unit and the components from operating in abnormal conditions. Protections can be divided in preventions and alarms. Alarms can then be divided in pump-down and rapid stop alarms. Pump-down alarms are activated when the system or sub-system can perform a normal shutdown in spite of the abnormal running conditions. Rapid stop alarms are activated when the abnormal running conditions require an immediate stop of the whole system or sub-system to prevent potential damages.

The UC displays the active alarms in a dedicated page and keep an history of the last 50 entries divided between alarms and acknowledges occurred. Time and date for each alarm event and of each alarm acknowledge are stored.

The UC also stores alarm snapshot of each alarm occurred. Each item contains a snapshot of the running conditions right before the alarm has occurred. Different sets of snapshots are programmed corresponding to unit alarms and circuit alarms holding different information to help the failure diagnosis.

In the following sections it will also be indicated how each alarm can be cleared between local HMI, Network (by any of the high level interfaces Modbus, Bacnet or Lon) or if the specific alarm will clear automatically. The following symbols are used:

<input checked="" type="checkbox"/>	Allowed
<input checked="" type="checkbox"/>	Not allowed
<input type="checkbox"/>	Not foreseen

6.1 Unit Alerts

6.1.1 Bad Demand Limit Input

This alarm is generated when the Demand Limit option has been enabled and the input to the controller is out of the admitted range.

Symptom	Cause	Solution
Unit status is Run. Bell icon is moving on controller's display. Demand Limit function cannot be used. String in the alarm list: BadDemandLimitInput String in the alarm log: ±BadDemandLimitInput String in the alarm snapshot BadDemandLimitInput	Demand limit input out of range. For this warning out of range is considered to be a signal less than 3mA or more than 21mA.	Check for values of input signal to the unit controller. It has to be in the allowed mA range. Check for electrical shielding of wirings.
Reset		Check for right value of the unit's controller output in case input signal is into allowed range.
Local HMI Network Auto	<input type="checkbox"/> <input type="checkbox"/> <input checked="" type="checkbox"/>	Notes Automatically clears when the signal returns in the allowed range.

6.1.2 Bad Leaving Water Temperature Reset Input

This alarm is generated when the Setpoint Reset option has been enabled and the input to the controller is out of the admitted range.

Symptom	Cause	Solution
Unit status is Run. Bell icon is moving on controller's display. LWT Reset function cannot be used. String in the alarm list: BadSetPtOverrideInput String in the alarm log: ± BadSetPtOverrideInput String in the alarm snapshot BadSetPtOverrideInput	LWT reset input signal is out of range. For this warning out of range is considered to be a signal less than 3mA or more than 21mA.	Check for values of input signal to the unit controller. It has to be in the allowed mA range. Check for electrical shielding of wirings.
Reset		Check for right value of the unit's controller output in case input signal is into allowed range.
Local HMI Network Auto	<input type="checkbox"/> <input type="checkbox"/> <input checked="" type="checkbox"/>	Notes Automatically clears when the signal returns in the allowed range.

6.1.3 Condenser Pump #1 Failure (W/C units only)

This alarm is generated if the pump is started but the flow switch is not able to close within the recirculate time. This can be a temporary condition or may be due to a broken flowswitch, the activation of circuit breakers, fuses or to a pump breakdown.

Symptom	Cause	Solution
Unit could be ON. Bell icon is moving on controller's display. Backup pump is used or stop of all circuits in case of pump #2 failure. String in the alarm list: CondPump1Fault String in the alarm log: ± CondPump1Fault String in the alarm snapshot CondPump1Fault	Pump #1 may not be operating.	Check for problem in electrical wiring of the pump #1. Check that electrical breaker of pump #1 is tripped. If fuses are used to protect the pump, check the integrity of fuses.
	Flow Switch doesn't operate properly	Check for problem in wiring connection between pump starter and unit controller. Check the water pump filter and the water circuit for obstructions.
Reset		Check flow switch connection and calibration.
Local HMI Network Auto	<input checked="" type="checkbox"/> <input checked="" type="checkbox"/> <input type="checkbox"/>	Notes

6.1.4 Condenser Pump #2 Failure (W/C units only)

This alarm is generated if the pump is started but the flow switch is not able to close within the recirculate time. This can be a temporary condition or may be due to a broken flowswitch, the activation of circuit breakers, fuses or to a pump breakdown.

Symptom	Cause	Solution
Unit could be ON. Bell icon is moving on controller's display. Backup pump is used or stop of all circuits in case of pump #1 failure. String in the alarm list: CondPump2Fault String in the alarm log: ± CondPump2Fault String in the alarm snapshot CondPump2Fault	Pump #1 may not be operating.	Check for problem in electrical wiring of the pump #1. Check that electrical breaker of pump #1 is tripped. If fuses are used to protect the pump, check the integrity of fuses.
	Flow Switch doesn't operate properly	Check for problem in wiring connection between pump starter and unit controller. Check the water pump filter and the water circuit for obstructions.
Reset		Check flow switch connection and calibration.
Local HMI Network Auto	<input checked="" type="checkbox"/> <input checked="" type="checkbox"/> <input type="checkbox"/>	Notes

6.1.5 Evaporator Pump #1 Failure

This alarm is generated if the pump is started but the flow switch is not able to close within the recirculate time. This can be a temporary condition or may be due to a broken flowswitch, the activation of circuit breakers, fuses or to a pump breakdown.

Symptom	Cause	Solution
Unit could be ON. Bell icon is moving on controller's display. Backup pump is used or stop of all circuits in case of pump #2 failure. String in the alarm list: EvapPump1Fault String in the alarm log: ± EvapPump1Fault String in the alarm snapshot EvapPump1Fault	Pump #1 may not be operating.	Check for problem in electrical wiring of the pump #1. Check that electrical breaker of pump #1 is tripped. If fuses are used to protect the pump, check the integrity of fuses.
	Flow Switch doesn't operate properly	Check for problem in wiring connection between pump starter and unit controller. Check the water pump filter and the water circuit for obstructions.
Reset		Check flow switch connection and calibration.
Local HMI Network Auto	<input checked="" type="checkbox"/> <input checked="" type="checkbox"/> <input type="checkbox"/>	Notes

6.1.6 Evaporator Pump #2 Failure

This alarm is generated if the pump is started but the flow switch is not able to close within the recirculate time. This can be a temporary condition or may be due to a broken flowswitch, the activation of circuit breakers, fuses or to a pump breakdown.

Symptom	Cause	Solution
Unit could be ON. Bell icon is moving on controller's display. Backup pump is used or stop of all circuits in case of pump #1 failure.	Pump #2 may not be operating.	Check for problem in electrical wiring of the pump #2. Check that electrical breaker of pump #2 is tripped.

String in the alarm list: EvapPump2Fault String in the alarm log: ± EvapPump2Fault String in the alarm snapshot EvapPump2Fault		If fuses are used to protect the pump, check the integrity of fuses.
		Check for problem in wiring connection between pump starter and unit controller.
		Check the water pump filter and the water circuit for obstructions.
	Flow Switch doesn't operate properly	Check flow switch connection and calibration.
Reset		Notes
Local HMI Network Auto	<input checked="" type="checkbox"/> <input checked="" type="checkbox"/> <input type="checkbox"/>	

6.1.7 External Event

This alarm indicates that a device, whose operation is linked with this machine, is reporting a problem on the dedicated input.

Symptom	Cause	Solution
Unit status is Run. Bell icon is moving on controller's display. String in the alarm list: UnitExternalEvent String in the alarm log: ± UnitExternalEvent String in the alarm snapshot UnitExternalEvent	There is an external event that has caused the opening, for at least 5 seconds, of the digital input on the controller board.	Check for reasons of external event and if it can be a potential problem for a correct chiller operation.
Reset		Notes
Local HMI Network Auto	<input type="checkbox"/> <input type="checkbox"/> <input checked="" type="checkbox"/>	The alarm is automatically cleared when the problem is solved.
NOTE: What above applies in case of configuration of the external fault digital input as Event		

6.1.8 Password Over Time

This alarm indicates that a device, whose operation is linked with this machine, is reporting a problem on the dedicated input.

Symptom	Cause	Solution
Pass1TimeOver 1dayleft	Temporary Password Inserted is going to expire. One day is left before Option set is unactivated.	A Permanent Password must be inserted in order to keep on using selected software option set. Refer to Chapter "Software Options".
Pass1TimeOver 1dayleft		
Pass1TimeOver 1dayleft		
Reset		
Local HMI Network Auto	<input checked="" type="checkbox"/> <input type="checkbox"/> <input type="checkbox"/>	

6.2 Unit Pumpdown Stop Alarms

6.2.1 Condenser Entering Water Temperature (EWT) sensor fault

This alarm is generated any time the input resistance is out of an acceptable range.

Symptom	Cause	Solution
Unit status is Off. All circuits are stopped with a normal shutdown procedure. Bell icon is moving on controller's display. String in the alarm list: UnitOffCndEntWTempSen String in the alarm log: ± UnitOffCndEntWTempSen String in the alarm snapshot UnitOffcndEntWTempSen	Sensor is broken.	Check for sensor integrity according table and allowed kOhm (kΩ) range. Check correct sensors operation
	Sensor is shorted.	Check if sensor is shorted with a resistance measurement.
	Sensor is not properly connected (open).	Check for absence of water or humidity on electrical contacts.
		Check for correct plug-in of the electrical connectors.
Reset		Notes
Local HMI Network Auto	<input checked="" type="checkbox"/> <input checked="" type="checkbox"/> <input type="checkbox"/>	

6.2.2 Condenser Leaving Water Temperature (LWT) sensor fault

This alarm is generated any time the input resistance is out of an acceptable range.

Symptom	Cause	Solution
Unit status is Off. All circuits are stopped with a normal shutdown procedure. Bell icon is moving on controller's display. String in the alarm list: UnitOffCndLvgWTempSen String in the alarm log: ± UnitOffCndLvgWTempSen String in the alarm snapshot UnitOffcndLvgWTempSen	Sensor is broken.	Check for sensor integrity according table and allowed kOhm (kΩ) range. Check correct sensors operation
	Sensor is shorted.	Check if sensor is shorted with a resistance measurement.
	Sensor is not properly connected (open).	Check for absence of water or humidity on electrical contacts.
		Check for correct plug-in of the electrical connectors. Check for correct sensors wiring also according electrical scheme.
Reset		Notes
Local HMI	<input checked="" type="checkbox"/>	
Network	<input checked="" type="checkbox"/>	
Auto	<input type="checkbox"/>	

6.2.3 Evaporator Entering Water Temperature (EWT) sensor fault

This alarm is generated any time the input resistance is out of an acceptable range.

Symptom	Cause	Solution
Unit status is Off. All circuits are stopped with a normal shutdown procedure. Bell icon is moving on controller's display. String in the alarm list: UnitOffEvpEntWTempSen String in the alarm log: ± UnitOffEvpEntWTempSen String in the alarm snapshot UnitOffEvpEntWTempSen	Sensor is broken.	Check for sensor integrity according table and allowed kOhm (kΩ) range. Check correct sensors operation
	Sensor is shorted.	Check if sensor is shorted with a resistance measurement.
	Sensor is not properly connected (open).	Check for absence of water or humidity on electrical contacts.
		Check for correct plug-in of the electrical connectors. Check for correct sensors wiring also according electrical scheme.
Reset		Notes
Local HMI	<input checked="" type="checkbox"/>	
Network	<input checked="" type="checkbox"/>	

6.2.4 Evaporator Water Temperatures inverted

This alarm is generated any time the entering water temperature is lower than the leaving by 1°C and at least one compressor is running since 90 seconds.

Symptom	Cause	Solution
Unit status is Off. All circuits are stopped with a normal shutdown procedure. Bell icon is moving on controller's display. String in the alarm list: UnitOffEvpWTempInvrtd String in the alarm log: ± UnitOffEvpWTempInvrtd String in the alarm snapshot UnitOffEvpWTempInvrtd	Entering and leaving water temperature sensors are inverted.	Check cabling of the sensors on the unit controller. Check offset of the two sensors with the water pump running
	Entering and leaving water pipes are reversed	Check if the water flows in counter flow respect to refrigerant.
	Water pump operate reverse.	Check if the water flows in counter flow respect to refrigerant.
Reset		Notes
Local HMI	<input checked="" type="checkbox"/>	
Network	<input checked="" type="checkbox"/>	
Auto	<input type="checkbox"/>	

6.2.5 Liquid Temperature Sensor fault

This alarm is generated to indicate that the sensor is not reading properly.

Symptom	Cause	Solution
Circuit status is Off. The circuit is switched off with the normal shutdown procedure. Bell icon is moving on controller's display. String in the alarm list: UnitOffLiquidTempSen String in the alarm log: ± UnitOffLiquidTempSen String in the alarm snapshot UnitOffLiquidTempSen	Sensor is shorted.	Check for sensor integrity.
		Check correct sensors operation according information about kOhm (kΩ) range related to temperature values.
	Sensor is broken.	Check if sensor is shorted with a resistance measurement.
	Sensor is not properly connected (open).	Check for correct installation of the sensor on refrigerant circuit pipe.
Check for absence of water or humidity on sensor electrical contacts.		

		Check for correct plug-in of the electrical connectors.
		Check for correct sensors wiring also according with electrical scheme.
Reset		Notes
Local HMI	<input checked="" type="checkbox"/>	
Network	<input checked="" type="checkbox"/>	
Auto	<input type="checkbox"/>	

6.3 Unit Rapid Stop Alarms

6.3.1 PVM alarm (A/C units only)

This alarm is generated in case of problems with the power supply to the chiller.



Resolution of this fault requires a direct intervention on the power supply of this unit. Direct intervention on the power supply can cause electrocution, burns or even death. This action must be performed only by trained persons. In case of doubts contact your maintenance company.

Symptom	Cause	Solution
Unit status is Off. All circuits are stopped immediately. Bell icon is moving on controller's display. String in the alarm list: UnitOffPhaveVoltage String in the alarm log: ± UnitOffPhaveVoltage String in the alarm snapshot UnitOffPhaveVoltage	Loss of one phase.	Check voltage level on each of the phases.
	Not correct sequence connection of L1,L2,L3.	Check sequence of L1, L2, L3 connections according indication on chiller's electrical scheme.
	Voltage level on the unit's panel is not in the allowed range (±10%).	Check that voltage level on each phases is into the allowed range that is indicated on the chiller label. Is important to check the voltage level on each phases not only with chiller not running, but mainly with chiller running from minimum capacity up to full load capacity. That's because voltage drop can occur from a certain unit cooling capacity level, or because of certain working condition (i.e. high values of OAT). In these cases the issue can be related with the sizing of power cables.
	There is a short-circuit on the unit.	Check for correct electrical isolation condition of each unit's circuit with a Megger tester.
Reset		Notes
Local HMI	<input type="checkbox"/>	
Network	<input checked="" type="checkbox"/>	
Auto	<input checked="" type="checkbox"/>	

6.3.2 Condenser Water Freeze alarm (W/C units only)

This alarm is generated to indicate that the water temperature (entering or leaving) has dropped below a safety limit. Control tries to protect the heat exchanger starting the pump and letting the water circulate.

Symptom	Cause	Solution
Unit status is Off. All circuits are stopped immediately. Bell icon is moving on controller's display. String in the alarm list: UnitOffCondWaterTmpLo String in the alarm log: ± UnitOffCondWaterTmpLo String in the alarm snapshot UnitOffCondWaterTmpLo	Water flow too low.	Increase the water flow.
	Inlet temperature to the evaporator is too low.	Increase the inlet water temperature.
	Flow switch is not working or no water flow.	Check the flow switch and the water pump.
	Refrigerant temperature become too low (< -0.6°C).	Check the water flow and filter. No good heat exchange condition into the evaporator.
	Sensors readings (entering or leaving) are not properly calibrated	Check the water temperatures with a proper instrument and adjust the offsets
	Wrong freeze limit setpoint	The freeze limit has not been changed as a function of glycol percentage.
Reset		Notes
Local HMI	<input checked="" type="checkbox"/>	
Network	<input checked="" type="checkbox"/>	
Auto	<input type="checkbox"/>	

6.3.3 Condenser Water Flow Loss alarm (W/C units only)

This alarm is generated in case of flow loss to the chiller to protect the machine against Mechanical High Pressure trips.

Symptom	Cause	Solution
Unit status is Off. All circuits are stopped immediately. Bell icon is moving on controller's display. String in the alarm list: UnitOffCondWaterFlow String in the alarm log: ± UnitOffCondWaterFlow String in the alarm snapshot UnitOffCondWaterFlow	No water flow sensed for 3 minutes continuously or water flow too low.	Check the water pump filler and the water circuit for obstructions.
		Check the flow switch calibration and adapt to minimum water flow.
		Check if pump impeller can rotate freely and has no damages.
		Check pumps protection devices (circuit breakers, fuses, inverters, etc.)
		Check if water filter is clogged.
Reset		Check flow switch connections.
Reset		Notes
Local HMI	<input checked="" type="checkbox"/>	
Network	<input checked="" type="checkbox"/>	
Auto	<input type="checkbox"/>	

6.3.4 Emergency Stop

This alarm is generated any time the Emergency Stop button is activated.



Before resetting the Emergency Stop button please verify that the harmful condition has been removed.

Symptom	Cause	Solution
Unit status is Off. All circuits are stopped immediately. Bell icon is moving on controller's display. String in the alarm list: UnitOffEmergencyStop String in the alarm log: ± UnitOffEmergencyStop String in the alarm snapshot UnitOffEmergencyStop	Emergency stop button has been pushed.	Turning counterclockwise the emergency stop button, the alarm should be cleared.
Reset		Notes
Local HMI	<input checked="" type="checkbox"/>	Please see note on the top.
Network	<input checked="" type="checkbox"/>	
Auto	<input type="checkbox"/>	

6.3.5 Evaporator Flow Loss alarm

This alarm is generated in case of flow loss to the chiller to protect the machine against freezing.

Symptom	Cause	Solution
Unit status is Off. All circuits are stopped immediately. Bell icon is moving on controller's display. String in the alarm list: UnitOffEvapWaterFlow String in the alarm log: ± UnitOffEvapWaterFlow String in the alarm snapshot UnitOffEvapWaterFlow	No water flow sensed for 3 minutes continuously or water flow too low.	Check the water pump filler and the water circuit for obstructions.
		Check the flow switch calibration and adapt to minimum water flow.
		Check if pump impeller can rotate freely and has no damages.
		Check pumps protection devices (circuit breakers, fuses, inverters, etc.)
		Check if water filter is clogged.
Reset		Check flow switch connections.
Reset		Notes
Local HMI	<input checked="" type="checkbox"/>	
Network	<input checked="" type="checkbox"/>	
Auto	<input type="checkbox"/>	

6.3.6 Evaporator Leaving Water Temperature (LWT) sensor fault

This alarm is generated any time that the input resistance is out of an acceptable range.

Symptom	Cause	Solution
Unit status is Off. All circuits are stopped with a normal shutdown procedure. Bell icon is moving on controller's display. String in the alarm list: UnitOffLvgEntWTempSen String in the alarm log:	Sensor is broken.	Check for sensor integrity according table and allowed kOhm (kΩ) range. Check correct sensors operation
	Sensor is shorted.	Check if sensor is shorted with a resistance measurement.
	Sensor is not properly connected (open).	Check for absence of water or humidity on electrical contacts.

± UnitOffLvgEntWTempSen String in the alarm snapshot UnitOffEvpLvgWTempSen		Check for correct plug-in of the electrical connectors. Check for correct sensors wiring also according electrical scheme.
Reset		Notes
Local HMI Network Auto	<input checked="" type="checkbox"/> <input checked="" type="checkbox"/> <input type="checkbox"/>	

6.3.7 Evaporator Water Freeze alarm

This alarm is generated to indicate that the water temperature (entering or leaving) has dropped below a safety limit. Control tries to protect the heat exchanger starting the pump and letting the water circulate.

Symptom	Cause	Solution
Unit status is Off. All circuits are stopped immediately. Bell icon is moving on controller's display. String in the alarm list: UnitOffEvapWaterTmpLo String in the alarm log: ± UnitOffEvapWaterTmpLo String in the alarm snapshot UnitOffEvapWaterTmpLo	Water flow too low.	Increase the water flow.
	Inlet temperature to the evaporator is too low.	Increase the inlet water temperature.
	Flow switch is not working or no water flow.	Check the flow switch and the water pump.
	Sensors readings (entering or leaving) are not properly calibrated.	Check the water temperatures with a proper instrument and adjust the offsets
	Wrong freeze limit setpoint.	The freeze limit has not been changed as a function of glycol percentage.
Reset		Notes
Local HMI Network Auto	<input checked="" type="checkbox"/> <input checked="" type="checkbox"/> <input type="checkbox"/>	It's required to check if the evaporator has any damage due to this alarm.

6.3.8 External alarm

This alarm is generated to indicate that an external device whose operation is linked with this unit operation. This external device could be a pump or an inverter.

Symptom	Cause	Solution
Unit status is Off. All circuits are switched off with the normal shutdown procedure. Bell icon is moving on controller's display. String in the alarm list: UnitOffExternalAlarm String in the alarm log: ± UnitOffExternalAlarm String in the alarm snapshot UnitOffExternalAlarm	There is an external event that has caused the opening, for at least 5 seconds, of the port on the controller board.	Check causes of the external event or alarm.
		Check electrical wiring from unit controller to the external equipment in case of any external events or alarms have been occurred.
Reset		Notes
Local HMI Network Auto	<input checked="" type="checkbox"/> <input checked="" type="checkbox"/> <input type="checkbox"/>	
NOTE: What above applies in case of configuration of the external fault digital input as Alarm.		

6.3.9 Gas Leakage Alarm

This alarm is generated when the external leak detector(s) detects a refrigerant concentration higher than a threshold. To clear this alarm is required to clear the alarm either locally and, if needed, on the leak detector itself.

Symptom	Cause	Solution
Unit status is Off. All circuits are stopped immediately. Bell icon is moving on controller's display. String in the alarm list: UnitOffGasLeakage String in the alarm log: ± UnitOffGasLeakage String in the alarm snapshot UnitOffGasLeakage	Refrigerant leakage	Locate the leakage with a sniffer and fix the leakage
	Leak detector is not properly powered	Check the power supply of the leak detector.
	Leak detector is not properly connected to the controller.	Check the connection of the detector with reference to the wiring diagram of the unit.
	Leak detector is broken	Replace the leak detector.
	Leak detector is not required/needed	Check the configuration on the unit controller and disable this option.
Reset		Notes
Local HMI Network Auto	<input checked="" type="checkbox"/> <input checked="" type="checkbox"/> <input type="checkbox"/>	

6.3.10 Power Fault

This alarm is generated when the main power is Off and the unit controller is powered by the UPS.



Resolution of this fault requires a direct intervention on the power supply of this unit. Direct intervention on the power supply can cause electrocution, burns or even death. This action must be performed only by trained persons. In case of doubts contact your maintenance company.

Symptom	Cause	Solution
Unit status is Off. All circuits are stopped immediately. Bell icon is moving on controller's display. String in the alarm list: Power Fault String in the alarm log: ± Power Fault String in the alarm snapshot Power Fault	Loss of one phase.	Check voltage level on each of the phases.
	Not correct sequence connection of L1, L2, L3.	Check sequence of L1, L2, L3 connections according indication on chiller's electrical scheme.
	Voltage level on the unit's panel is not in the allowed range ($\pm 10\%$).	Check that voltage level on each phases is into the allowed range that is indicated on the chiller label. Is important to check the voltage level on each phases not only with chiller not running, but mainly with chiller running from minimum capacity up to full load capacity. That's because voltage drop can occur from a certain unit cooling capacity level, or because of certain working condition (i.e. high values of OAT). In these cases the issue can be related with the sizing of power cables.
	There is a short-circuit on the unit.	Check for correct electrical isolation condition of each unit's circuit with a Megger tester.
Reset		Notes
Local HMI Network Auto	<input checked="" type="checkbox"/> <input checked="" type="checkbox"/>	

6.3.11 Low Discharge Superheat

This alarm is generated in case of Low discharge superheat to one of the compressors when the unit is configured with the flash tank economizer. This alarm is activated only for 3-Compressor units.

Symptom	Cause	Solution
Unit status is Off. All circuits are stopped immediately. Bell icon is moving on controller's display. String in the alarm list: UnitOffLowDishSh String in the alarm log: ± UnitOffLowDishSh String in the alarm snapshot UnitOffLowDishSh	Float valve is blocked totally or partially closed.	Try clear the alarm and restart the unit. If the problem persists contact your Daikin Service reference.
Reset		Notes
Local HMI Network Auto	<input checked="" type="checkbox"/> <input type="checkbox"/> <input type="checkbox"/>	

6.3.12 Mechanical High Pressure Switch Alarm

This alarm is generated when the condenser pressure rises above the mechanical high pressure limit causing this device to open the power supply to all the auxiliary relays. This causes an immediate shutdown of compressor and all the other actuators in this circuit.

Symptom	Cause	Solution
Circuit status is Off. The compressor does not load anymore or even unload, circuit is stopped. Bell icon is moving on controller's display. String in the alarm list: C1 OffMechPressHi String in the alarm log: ± C1 OffMechPressHi String in the alarm snapshot C1 OffMechPressHi	Condenser pump may not be operating correctly (W/C units)	Check if the pump can run and give the required water flow.
	Dirty condenser heat exchanger.	Clean the condenser heat exchanger.
	Entering water temperature at condenser is too high.	Check the cooling tower operation and settings.
		Check the three way valve operation and settings.
	Mechanical high pressure switch is damaged or not calibrated.	Check for proper operation of the high pressure switch.
Reset		Notes
Local HMI Network Auto	<input checked="" type="checkbox"/> <input checked="" type="checkbox"/> <input checked="" type="checkbox"/>	Reset of this alarm requires a manual action on the high pressure switch.

6.3.13 High Pressure Alarm

This alarm is generated in case the Condensing saturated temperature rise above the Maximum condensing saturated temperature and the control is not able to compensate to this condition. The maximum condenser saturated temperature depends on compressor model. In case of water cooled chillers operating at high condenser water temperature, if the Condensing saturated temperature exceeds the Maximum condenser saturated temperature, the circuit is only switched off without any notification on the screen as this condition is considered acceptable in this range of operation.

Symptom	Cause	Solution	
Circuit status is Off. The compressor does not load anymore or even unload, circuit is stopped. Bell icon is moving on controller's display. String in the alarm list: C1 UnitOffCondPress String in the alarm log: ± C1 UnitOffCondPress String in the alarm snapshot C1 UnitOffCondPress	One or more condenser fans do not operate properly (A/C units).	Check if fans protections have been activated.	
		Check that the fans can turn freely.	
		Check that there is not any obstacle to the free ejection of the air blown.	
		Condenser pump may not be operating correctly (W/C units)	Check if the pump can run and give the required water flow.
		Dirty or partially blocked condenser coil (A/C units).	Remove any obstacle; Clean the condenser coil using soft brush and blower.
		Dirty condenser heat exchanger (W/C units)	Clean the condenser heat exchanger.
		Inlet air temperature of the condenser is too high (A/C units).	The air temperature measured at the inlet of the condenser may not exceed the limit indicated in the operational range (working envelope) of the chiller.
			Check the location where the unit is installed and check that there are no any short circuit of the hot-air blown from the fans of the same unit, or even from fans of next chillers (Check IOM for proper installation).
		Entering water temperature at condenser is too high (W/C units).	Check the cooling tower operation and settings.
			Check the three way valve operation and settings.
	One or more condenser fan turning in wrong direction (A/C units).	Check for correct phases sequence (L1, L2, L3) in the electrical connection of the fans.	
	Excessive charge of refrigerant into the unit.	Check liquid sub-cooling and suction super-heat to control indirectly the correct charge of refrigerant. If necessary recover all the refrigerant to weight the entire charge and to	

		control if the value is in line with kg indication on unit label.
	Condensing pressure transducer could not operate properly.	Check for proper operation of the high pressure sensor.
	Wrong unit configuration (W/C units).	Check that the unit has been configured for high condenser temperature applications.
Reset		Notes
Local HMI Network Auto	<input checked="" type="checkbox"/> <input checked="" type="checkbox"/> <input type="checkbox"/>	

6.3.14 Low Pressure Alarm

This alarm is generated in case the evaporating pressure drops below the Low Pressure Unload and the control is not able to compensate to this condition.

Symptom	Cause	Solution	
Circuit status is Off. The compressor does not load anymore or even unload, circuit is stopped immediately. Bell icon is moving on controller's display. String in the alarm list: C1 UnitOffEvapPress String in the alarm log: ± C1 UnitOffEvapPress String in the alarm snapshot C1 UnitOffEvapPress	Transitory condition like a fan staging on cooling tower.	Wait until the condition is recovered by EXV control	
	Refrigerant charge is low.	Check sight glass on liquid line to see if there is flash gas. Measure sub-cooling to see if the charge is correct.	
	Protection limit not set to fit customer application.	Check the evaporator approach and the corresponding water temperature to evaluate the low pressure hold limit.	
	High Evaporator Approach.	Clean the evaporator Check the quality of the fluid that flows into heat exchanger. Check the glycol percentage and type (ethilenic or propilenic)	
	Water flow into water heat exchanger is too low.	Increase the water flow. Check that evaporator water pump is operating correctly providing the required water flow.	
	Evaporating pressure transducer is not working properly.	Check the sensor for proper operation and calibrate the readings with a gauge.	
	EEXV is not working correctly. It's not opening enough or it's moving in the opposite direction.	Check if pump-down can be finished for pressure limit reached; Check expansion valve movements. Check connection to the valve driver on the wiring diagram. Measure the resistance of each winding, it has to be different from 0 Ohm.	
	Water temperature is low	Increase inlet water temperature. Check the low pressure safeties settings.	
	Reset		Notes
	Local HMI Network Auto	<input checked="" type="checkbox"/> <input checked="" type="checkbox"/> <input type="checkbox"/>	

6.3.15 Compressor Extension Communication Error

This alarm is generated in case of communication problems with the Compressor extension module.

Symptom	Cause	Solution
Circuit status is Off. All circuits are stopped immediately. Bell icon is moving on controller's display. String in the alarm list: Cx OffCmpCtrlrComFail String in the alarm log: ± Cx OffCmpCtrlrComFail String in the alarm snapshot Cx OffCmpCtrlrComFail	Module has no power supply	Check the power supply from the connector on the side of the module.
		Check if LEDs are both green.
		Check if the connector on the side is tightly inserted in the module
	Module address is not properly set	Check if module's address is correct referring to the wiring diagram.
Reset	Module is broken	Check if LED are on and both green. If BSP LED is solid red replace the module
		Check if power supply is ok but LEDs are both off. In this case replace the module
Local HMI	<input checked="" type="checkbox"/>	Notes
Network	<input checked="" type="checkbox"/>	
Auto	<input type="checkbox"/>	

6.3.16 EXV Driver Extension Communication Error

This alarm is generated in case of communication problems with the EEXVx module.

Symptom	Cause	Solution
Circuit status is Off. All circuits are stopped immediately. Bell icon is moving on controller's display. String in the alarm list: Cx OffEXVCtrlr(x)ComFail String in the alarm log: ± Cx OffEXVCtrlr(x)ComFail String in the alarm snapshot Cx OffEXVCtrlr(x)ComFail	Module has no power supply	Check the power supply from the connector on the side of the module.
		Check if LEDs are both green.
		Check if the connector on the side is tightly inserted in the module
	Module address is not properly set	Check if module's address is correct referring to the wiring diagram.
Reset	Module is broken	Check if LED are on and both green. If BSP LED is solid red replace the module
		Check if power supply is ok but LEDs are both off. In this case replace the module
Local HMI	<input checked="" type="checkbox"/>	Notes
Network	<input checked="" type="checkbox"/>	
Auto	<input type="checkbox"/>	

6.3.1 Hot Gas Bypass Driver Extension Communication Error

This alarm is generated in case of communication problems with the HGB module.

Symptom	Cause	Solution
Circuit status is Off. All circuits are stopped immediately. Bell icon is moving on controller's display. String in the alarm list: Unit HGBDrvCommFail String in the alarm log: ± Unit HGBDrvCommFail String in the alarm snapshot Unit HGBDrvCommFail	Module has no power supply	Check the power supply from the connector on the side of the module.
		Check if LEDs are both green.
		Check if the connector on the side is tightly inserted in the module
	Module address is not properly set	Check if module's address is correct referring to the wiring diagram.
Reset	Module is broken	Check if LED are on and both green. If BSP LED is solid red replace the module
		Check if power supply is ok but LEDs are both off. In this case replace the module
Local HMI	<input checked="" type="checkbox"/>	Notes
Network	<input checked="" type="checkbox"/>	
Auto	<input type="checkbox"/>	

6.4 Compressor Alerts

6.4.1 Power Loss

This alarm indicates that a short under voltage on main power supply, that does not turn off the unit, has occurred.



**Resolution of this fault requires a direct intervention on the power supply of this unit.
Direct intervention on the power supply can cause electrocution, burns or even death. This action must be performed only by trained persons. In case of doubts contact your maintenance company.**

Symptom	Cause	Solution
Circuit status is On. The controller brings the compressor to the minimum speed and then normal operation is recovered (default 1200rpm) Bell icon is moving on controller's display. String in the alarm list: Cx PwrLossRun String in the alarm log: ± Cx PwrLossRun String in the alarm snapshot Cx PwrLossRun	Chiller main power supply had a down peak which caused the trip.	Check if main power supply is within the acceptable tolerance for this chiller
Reset		Notes
Local HMI Network Auto	<input type="checkbox"/> <input type="checkbox"/> <input checked="" type="checkbox"/>	

6.5 Circuit Pumpdown Stop Alarms

6.5.1 Low Discharge Superheat fault

This alarm indicates that the unit has worked for too long with low discharge super heat.

Symptom	Cause	Solution
Compressor status is Off. The circuit is switched off with the shutdown procedure. Bell icon is moving on controller's display. String in the alarm list: C1Cmpx OffDishSHLo String in the alarm log: ± C1Cmpx OffDishSHLo String in the alarm snapshot C1Cmpx OffDishSHLo	EEXV is not working correctly. It's not opening enough or it's moving in the opposite direction.	Check if pump-down can be finished for pressure limit reached; Check expansion valve movements. Check connection to the valve driver on the wiring diagram. Measure the resistance of each winding, it has to be different from 0 Ohm.
Reset		Notes
Local HMI Network Auto	<input checked="" type="checkbox"/> <input checked="" type="checkbox"/> <input checked="" type="checkbox"/> x 2 attempts (W/C only)	

6.5.2 Suction Temperature Sensor fault

This alarm is generated to indicate that the sensor is not reading properly.

Symptom	Cause	Solution
Compressor status is Off. The circuit is switched off with the normal shutdown procedure. Bell icon is moving on controller's display. String in the alarm list: C1Cmpx OffSuctTemp String in the alarm log: ± C1Cmpx OffSuctTemp String in the alarm snapshot C1Cmpx OffSuctTemp	Sensor is shorted.	Check for sensor integrity. Check correct sensors operation according information about kOhm (kΩ) range related to temperature values.
	Sensor is broken.	Check if sensor is shorted with a resistance measurement.
	Sensor is not good connected (open).	Check for correct installation of the sensor on refrigerant circuit pipe. Check for absence of water or humidity on sensor electrical contacts. Check for correct plug-in of the electrical connectors. Check for correct sensors wiring also according with electrical scheme.
Reset		Notes
Local HMI Network Auto	<input checked="" type="checkbox"/> <input checked="" type="checkbox"/> <input type="checkbox"/>	

6.6 Circuit Rapid Stop Alarms

6.6.1 Compressor VFD Fault

This alarm indicates an abnormal condition that forced the inverter to stop.

Symptom	Cause	Solution
Circuit status is Off. The compressor does not load anymore, circuit is immediately stopped. Bell icon is moving on controller's display. String in the alarm list: C1Cmpx VfdFault String in the alarm log: ± C1Cmpx VfdFault String in the alarm snapshot C1Cmpx VfdFault	Inverter is operating in an unsafe condition and for this reason the inverter must be stopped.	Check the alarm snapshot to identify the alarm code from the inverter. Contact your service organization to get the problem solved.
Reset		Notes
Local HMI Network Auto	<input checked="" type="checkbox"/> <input checked="" type="checkbox"/> <input type="checkbox"/>	

6.6.2 High Motor Current Alarm

This alarm indicates that the compressor absorbed current is exceeding a predefined limit.

Symptom	Cause	Solution
Circuit status is Off. The compressor does not load anymore or even unload, circuit is stopped. Bell icon is moving on controller's display. String in the alarm list: C1Cmp1 OffVfdOverCurr String in the alarm log: ± C1Cmp1 OffVfdOverCurr String in the alarm snapshot C1Cmp1 OffVfdOverCurr	The ambient temperature is too high (A/C units) or condenser water temperature is higher than the limit set on the unit envelope (W/C units).	Check the unit selection to see if the unit can operate at full load.
		Check if all fans are operating properly and are able to keep the condensing pressure at the proper level (A/C units).
		Clean condenser coils to allow a lower condensing pressure (A/C units).
		Check if condenser pump is operating correctly, giving enough water flow (W/C units).
	The wrong compressor model has been selected.	Clean condenser water heat exchanger (W/C units).
Reset		Notes
Local HMI Network Auto	<input checked="" type="checkbox"/> <input checked="" type="checkbox"/> <input type="checkbox"/>	

6.6.3 High Motor Temperature Alarm

This alarm indicates that the motor temperature has exceeded the maximum temperature limit for safe operations.

Symptom	Cause	Solution
Compressor status is Off. The compressor does not load anymore or even unload, circuit is stopped. Bell icon is moving on controller's display. String in the alarm list: C1Cmpx OffMotorTempHi String in the alarm log: ± C1Cmpx OffMotorTempHi String in the alarm snapshot C1Cmpx OffMotorTempHi	Insufficient motor cooling.	Check refrigerant charge.
		Check if operational envelope of the unit is respected.
	Motor temperature sensor could not operate properly.	Check the readings of the motor temperature sensor and check the Ohmic value. A correct reading should be around hundreds of Ohm at ambient temperature. Check the electrical connection of the sensor with the electronic board.
Reset		Notes
Local HMI Network Auto	<input checked="" type="checkbox"/> <input checked="" type="checkbox"/> <input type="checkbox"/>	

6.6.4 Overvoltage Alarm

This alarm indicates that chiller supply voltage exceeded the maximum limit which allows proper operations of the components. This is estimated looking at the DC voltage on the inverter which depends of course from the main power.



Resolution of this fault requires a direct intervention on the power supply of this unit.
Direct intervention on the power supply can cause electrocution, burns or even death. This action must be performed only by trained persons. In case of doubts contact your maintenance company.

Symptom	Cause	Solution
Compressor status is Off. The circuit is stopped. Bell icon is moving on controller's display. String in the alarm list: C1Cmpx OffOverVoltage String in the alarm log: ± C1Cmpx OffOverVoltage String in the alarm snapshot C1Cmpx OffOverVoltage	Chiller main power supply had an up peak which caused the trip.	Check if main power supply is within the acceptable tolerance for this chiller
	Main power supply setting on the MicroTech is not suitable with the power supply in use (A/C units).	Measure the power supply to the chiller and select the proper value on the MicroTech HMI.
Reset		Notes
Local HMI Network Auto	<input checked="" type="checkbox"/> <input checked="" type="checkbox"/> <input checked="" type="checkbox"/>	The alarm clears automatically when the voltage is reduced to an acceptable limit.

6.6.5 Undervoltage Alarm

This alarm indicates that chiller supply voltage exceeded the minimum limit which allows proper operations of the components.



Resolution of this fault requires a direct intervention on the power supply of this unit.
Direct intervention on the power supply can cause electrocution, burns or even death. This action must be performed only by trained persons. In case of doubts contact your maintenance company.

Symptom	Cause	Solution
Compressor status is Off. The circuit is stopped. Bell icon is moving on controller's display. String in the alarm list: C1Cmpx OffUnderVoltage String in the alarm log: ± C1Cmpx OffUnderVoltage String in the alarm snapshot C1Cmpx OffUnderVoltage	Chiller main power supply had a down peak which caused the trip.	Check if main power supply is within the acceptable tolerance for this chiller
	Main power supply setting on the MicroTech is not suitable with the power supply in use (A/C units).	Measure the power supply to the chiller and select the proper value on the MicroTech HMI.
Reset		Notes
Local HMI Network Auto	<input checked="" type="checkbox"/> <input checked="" type="checkbox"/> <input checked="" type="checkbox"/>	The alarm clears automatically when the voltage is increased to an acceptable limit.

6.6.6 Compressor Lockout Fault

This alarm indicates that one of the BMC preconfigurable alarms has occurred. These Faults are instantaneous Lock Out Faults and will immediately cause the compressor to stop running and lock itself out.

Symptom	Cause	Solution
Compressor status is Off. The compressor does not load anymore or even unload, circuit is stopped. Bell icon is moving on controller's display. String in the alarm list: C1Cmp1 LockoutFault String in the alarm log: ± C1Cmp1 LockoutFault String in the alarm snapshot C1Cmp1 LockoutFault	One of the BMC preconfigurable alarms has occurred.	In order to reset the fault and the compressor, a power cycle will be required.
Reset		Notes
Local HMI Network Auto	<input checked="" type="checkbox"/> <input checked="" type="checkbox"/> <input type="checkbox"/>	

6.6.7 Compressor Fault

The alarm is generated by the BMC when internal faults are triggered.

Symptom	Cause	Solution
Compressor status is Off. The compressor does not load anymore or even unload, circuit is stopped. Bell icon is moving on controller's display. String in the alarm list: C1Cmp1 CompFault String in the alarm log: ± C1Cmp1 CompFault String in the alarm snapshot C1Cmp1 CompFault	BMC internal faults are triggered..	Contact Daikin Service.
Reset		Notes
Local HMI Network Auto	<input checked="" type="checkbox"/> <input checked="" type="checkbox"/> <input type="checkbox"/>	

6.6.1 Compressor Sensor Fault

The alarm indicates that a BMC's sensor fault has occurred.

Symptom	Cause	Solution
Compressor status is Off. The compressor does not load anymore or even unload, circuit is stopped. Bell icon is moving on controller's display. String in the alarm list: C1Cmp1 SensorFault String in the alarm log: ± C1Cmp1 SensorFault String in the alarm snapshot C1Cmp1 SensorFault	BMC sensor fault has been triggered.	Contact Daikin Service.
Reset		Notes
Local HMI Network Auto	<input checked="" type="checkbox"/> <input checked="" type="checkbox"/> <input type="checkbox"/>	

6.6.2 BMC Fault

This alarm indicates that the BMC System has failed.

Symptom	Cause	Solution
Compressor status is Off. The compressor does not load anymore or even unload, circuit is stopped. Bell icon is moving on controller's display. String in the alarm list: C1Cmp1 BMCFault String in the alarm log: ± C1Cmp1 BMCFault String in the alarm snapshot C1Cmp1 BMCFault	BMC Failure.	Contact Daikin Service.
Reset		Notes
Local HMI Network Auto	<input checked="" type="checkbox"/> <input checked="" type="checkbox"/> <input type="checkbox"/>	

6.6.3 Suction Pressure Sensor Fault

This alarm is generated to indicate that the sensor is not reading properly.

Symptom	Cause	Solution
Circuit status is On. Economizer is Off. Bell icon is moving on controller's display. String in the alarm list: C1Cmp1 SuctPressSenf String in the alarm log: ± C1Cmp1 SuctPressSenf String in the alarm snapshot C1Cmp1 SuctPressSenf	Sensor is shorted.	Check for sensor integrity.
	Sensor is broken.	Check correct sensors operation according information about kOhm (kΩ) range related to temperature values. Check if sensor is shorted with a resistance measurement.
	Sensor is not good connected (open).	Check for correct installation of the sensor on refrigerant circuit pipe.
		Check for absence of water or humidity on sensor electrical contacts.
Check for correct plug-in of the electrical connectors.		
Reset		Check for correct sensors wiring also according with electrical scheme.
Local HMI Network Auto	<input checked="" type="checkbox"/> <input checked="" type="checkbox"/> <input type="checkbox"/>	Notes

6.6.4 Discharge Pressure Sensor Fault

This alarm is generated to indicate that the sensor is not reading properly.

Symptom	Cause	Solution
Circuit status is On. Economizer is Off. Bell icon is moving on controller's display. String in the alarm list: C1Cmp1 DischPressSenf String in the alarm log: ± C1Cmp1 DischPressSenf String in the alarm snapshot C1Cmp1 DischPressSenf	Sensor is shorted.	Check for sensor integrity.
	Sensor is broken.	Check correct sensors operation according information about kOhm (kΩ) range related to temperature values. Check if sensor is shorted with a resistance measurement.
	Sensor is not good connected (open).	Check for correct installation of the sensor on refrigerant circuit pipe.
		Check for absence of water or humidity on sensor electrical contacts.
Check for correct plug-in of the electrical connectors.		
Reset		Check for correct sensors wiring also according with electrical scheme.
Local HMI Network Auto	<input checked="" type="checkbox"/> <input checked="" type="checkbox"/> <input type="checkbox"/>	Notes

6.6.5 Check Valve Leakage

This alarm indicates that check valve leakage has occurred.

Symptom	Cause	Solution
Compressor status is Off. The compressor does not load anymore or even unload, circuit is stopped. Bell icon is moving on controller's display. String in the alarm list: C1Cmp1 CheckVlvLeakg String in the alarm log: ± C1Cmp1 CheckVlvLeakg String in the alarm snapshot C1Cmp1 CheckVlvLeakg	when one of the compressors is running and the other is not, the pressure ratio on the stationary compressor exceeds a limit value.	Check chechvalve state.
		Check the Pressure Ratio read by controller.
Reset		Notes
Local HMI Network Auto	<input checked="" type="checkbox"/> <input checked="" type="checkbox"/> <input type="checkbox"/>	

6.6.6 Compressor Bearing Fault

This alarm indicates that the bearing system has failed.

Symptom	Cause	Solution
Compressor status is Off. The compressor does not load anymore or even unload, circuit is stopped. Bell icon is moving on controller's display. String in the alarm list: C1Cmp1 BearingFault String in the alarm log: ± C1Cmp1 BearingFault String in the alarm snapshot C1Cmp1 BearingFault	Compressor Startup has failed.	Check the settings of compressor start sequence.
	Bearings have been damaged.	Contact Daikin Service.
Reset		Notes
Local HMI Network Auto	<input checked="" type="checkbox"/> <input checked="" type="checkbox"/> <input type="checkbox"/>	

6.6.7 Discharge Temperature Sensor Fault

This alarm is generated to indicate that the sensor is not reading properly.

Symptom	Cause	Solution
Circuit status is Off. The circuit is switched off with the normal shutdown procedure. Bell icon is moving on controller's display. String in the alarm list: CxCmp1 OffDischTmpSen String in the alarm log: ± CxCmp1 OffDischTmpSen String in the alarm snapshot CxCmp1 OffDischTmpSen	Sensor is shorted.	Check for sensor integrity. Check correct sensors operation according information about kOhm (kΩ) range related to temperature values.
	Sensor is broken.	Check if sensor is shorted with a resistance measurement.
	Sensor is not properly connected (open).	Check for correct installation of the sensor on refrigerant circuit pipe.
		Check for absence of water or humidity on sensor electrical contacts.
	Check for correct plug-in of the electrical connectors.	
	Check for correct sensors wiring also according with electrical scheme.	
Reset		Notes
Local HMI Network Auto	<input checked="" type="checkbox"/> <input checked="" type="checkbox"/> <input type="checkbox"/>	

6.6.8 VFD Communication Failure

This alarm indicates a communication problem with the inverter.

Symptom	Cause	Solution
Compressor status is Off. The compressor does not load anymore, circuit is immediately stopped. Bell icon is moving on controller's display. String in the alarm list: C1Cmpx OffVfdCommFail String in the alarm log: ± C1Cmpx OffVfdCommFail String in the alarm snapshot C1Cmpx OffVfdCommFail	RS485 network is not properly cabled.	Check the continuity of the RS485 network with the unit off. There should be continuity from the main controller to the last inverter as indicated on the wiring diagram.
	Modbus communication is not running properly.	Check inverter addresses and addresses of all the additional devices in the RS485 network (for example the energy meter). All the addresses must be different.
	Modbus interface card can be faulty	Check with your service organization to evaluate this possibility and eventually replace the board.
Reset		Notes
Local HMI Network Auto	<input checked="" type="checkbox"/> <input checked="" type="checkbox"/> <input checked="" type="checkbox"/>	The alarm clears automatically when the communication is re-established.

7 OPTIONS

7.1 Energy Meter including Current Limit (Optional)

An energy meter can be optionally installed on the unit. The energy meter is connected through Modbus to the unit controller, which can display all relevant electrical data such as:

- Line to Line Voltage (per phase and average)
- Line Current (per phase and average)
- Active Power
- Cos Phi
- Active Energy

All these data can be also accessed from a BMS by connecting it to a communication module. See the communication module manual for details on the device and parameter settings.

Both the energy meter device and the unit controller need to be properly set. The instructions below detail how to set the energy meter. Refer to the specific instructions of the energy meter for more detail on the operation of the device.

Energy Meter Settings (Nemo D4-L / Nemo D4-Le)		
Password (Down+Enter)	1000	
Connection	3-2E	three phase Aron System
Address	020	
Baud	19.2	kbps
Par	None	parity bit
Time Out	3	sec
Password 2	2001	
CT ratio	see CT label	current transformer ratio (i.e if CT is 600:5, set to 120)
VT ratio	1	no voltage transformers (unless 690V chiller)

Once the energy meter has been configured, do the following steps in the unit controller:

- From Main Menu, go to View/Set Unit → Commission Unit → Configuration → Unit
- Set Energy Mtr = Nemo D4-L or Nemo D4-Le

The energy meter option integrates the current limit function, which allows the unit to limit its capacity in order not to exceed a pre-defined current setpoint. This setpoint can be set in the unit display or can be changed from an external 4-20 mA signal.

The current limit must be set according to the following instructions:

- From Main Menu, go to View/Set Unit → Power Conservation

The following settings related to current limit option are available into the menu:

Unit Current	Displays the unit current
Current Limit	Displays the active current limit (which can be given by an external signal if unit is in network mode)
Current Lim Sp	Set the current limit setpoint (if unit is in local mode)

7.2 Rapid Restart (Optional)

This chiller can activate a Rapid Restart (optional) sequence in reaction to a power failure. A digital contact is used to inform the controller that the feature is enabled. The feature is configured in the factory.

Rapid restart is activated under the following conditions:

- The power failure exists for up to 180 seconds
- The unit and circuit switches are ON.
- No unit or circuit alarms exist.
- The unit has been running in the normal Run state
- The BMS Chiller Enable setpoint is set to Enable when the control source is Network

If the power failure is more than 180 seconds, the unit will start based on the setting of the Stop-to-Start cycle timer (minimum setting of 3 minutes) and load per standard unit without Rapid Restart.

When Rapid Restart is active, the unit will restart within 30 seconds of power restoration. The time to restore full load can depend on system conditions and load.

For more information email info@daikinapplied.uk or visit www.daikinapplied.uk

For all Daikin Applied UK,
Daikin Applied Service &
Spares enquiries call us on:
0345 565 2700



Daikin Europe N.V. participates in the Eurovent Certified Performance programme for Liquid Chilling Packages and Hydronic Heat Pumps, Fan Coil Units and Variable Refrigerant Flow systems. Check ongoing validity of certificate:
www.eurovent-certification.com

The present publication is drawn up by way of information only and does not constitute an offer binding upon Daikin Europe N.V. Daikin Europe N.V. has compiled the content of this publication to the best of its knowledge. No express or implied warranty is given for the completeness, accuracy, reliability or fitness for particular purpose of its content and the products and services presented therein. Specifications are subject to change without prior notice. Daikin Europe N.V. explicitly rejects any liability for any direct or indirect damage, in the broadest sense, arising from or related to the use and/or interpretation of this publication. All content is copyrighted by Daikin Europe N.V.

