

Air and water cooled scroll chillers & heat pump

Operation manual

Water cooled ranges:

EWVQ-G Water-cooled scroll chillers / EWLQ-G (Condenser less) / EWHQ-G (Heat pump)

Air cooled ranges:

EWAQ-G / EWAQ-G / EWYQ-G (heat pump)

Refrigerant - R410A

D-EOMHW00107-15EN

Rev	00
Date	-
Supersedes	-

Table of Contents

1	SAFETY CONSIDERATIONS	6
1.1	General.....	6
1.2	Avoid electrocution	6
1.3	Safety Devices.....	7
1.3.1	General safety devices	7
1.3.2	Circuit safety devices	7
1.3.3	Component safety devices.....	7
1.4	Available sensors.....	9
1.4.1	Pressure transducers.....	9
1.4.2	Temperature sensors.....	9
1.4.3	Thermistors.....	9
1.5	Available Controls.....	9
1.5.1	Evaporator - Condenser pumps	9
1.5.2	Compressors	9
1.5.3	Expansion Valve	9
1.5.4	Four Way Valve	9
1.6	Abbreviations used	10
1.7	Customer Terminal Block Connections	10
1.7.1	Connections description and purpose	10
2	GENERAL DESCRIPTION	13
2.1	Overview.....	13
2.2	Controller Operating Limits	13
2.3	Controller Architecture	13
2.4	Communication Modules	14
2.4.1	Modbus Module installation	15
2.4.2	Bacnet Module installation	15
2.4.3	Lon Module installation	16
3	Using the Controller	16
3.1	General Recommendation	17
3.2	Browsing.....	17
3.3	Passwords.....	18

3.4	Editing	19
3.5	Basic Control System Diagnostic	20
3.6	Controller maintenance	21
3.7	Software Update procedure	22
3.8	Optional Remote User Interface	24
3.9	Embedded Web Interface	26
4	Menu Structure	28
4.1	Main Menu	28
4.2	View/Set Unit	29
4.2.1	Thermostat Ctrl	29
4.2.2	Network Ctrl	29
4.2.3	Unit Cond Ctrl (W/C only)	29
4.2.4	Pumps	30
4.2.5	Master/Slave	30
4.2.6	Date/Time	32
4.2.7	Power Conservation	32
4.2.8	Controller IP setup	32
4.3	View/Set Circuit	33
4.3.1	Settings	33
4.4	Tmp Setpoints	35
4.5	Temperatures	35
4.6	Available Modes	36
4.7	Timers	36
4.8	Alarms	36
4.9	Commission Unit	36
4.9.1	Configure Unit	37
4.9.2	Alarm Limits	37
4.9.3	Calibrate Unit Sensors	38
4.9.4	Calibrate Circuit Sensors	38
4.9.5	Unit Manual Control	39
4.9.6	Circuit 1 Manual Control	39
4.9.7	Scheduled Maintenance	40
4.10	Save and Restore	40

4.11	About this Chiller.....	41
5	Working with this unit.....	41
5.1	Unit Setup.....	41
5.1.1	Control Source.....	41
5.1.2	Available Mode Setting.....	42
5.1.3	Temperature Setpoint Settings.....	42
5.1.4	Thermostat Control Settings.....	43
5.1.5	Alarm Settings.....	45
5.1.6	Pumps.....	46
5.1.7	Power Conservation.....	46
5.2	Unit/Circuit Start-up.....	49
5.2.1	Prepare the unit to start.....	49
5.2.2	Preparing circuits to start.....	51
5.3	Circuit Capacity Control.....	52
5.3.1	Low Evaporating Pressure.....	52
5.3.2	High Condensing Pressure.....	53
5.4	Mode Change-Over (H/P only).....	53
5.5	Backup Heaters (A/C only).....	53
5.6	Condensation Control (W/C only).....	54
5.6.1	Pressure (W/C only).....	54
5.6.2	Cond In / Cond Out (W/C only).....	55
5.6.3	Fan Control (A/C only).....	55
5.7	EXV Control.....	55
5.8	Defrost (A/C only).....	56
5.9	Four Way Valve (H/P gas side reversal only).....	57
5.10	Master/Slave.....	57
5.10.1	Master Slave Overview.....	57
-	Plant 1 : Single Common Pump.....	58
-	Plant 2 : Single Chiller Pump.....	58
-	Plant 4. Chiller with sectioned evaporator.....	58
5.10.2	Electrical Connection.....	59
5.10.3	Master Slave Operation.....	61
5.10.4	Master Slave Options.....	63

6	Alarms	65
6.1.1	Unit Warning Alarms	65
6.1.2	Unit Pumpdown Stop Alarms	67
6.1.3	Unit Rapid Stop Alarms.....	69
6.1.4	Master Slave Alarm	72
6.1.5	Circuit Warning Alarms	74
6.1.6	Circuit Pumpdown Stop Alarms	75
6.1.7	Circuit Rapid Stop Alarms.....	75

1 SAFETY CONSIDERATIONS

1.1 General

Installation, start-up and servicing of equipment can be hazardous if certain factors particular to the installation are not considered: operating pressures, presence of electrical components and voltages and the installation site (elevated plinths and built-up up structures). Only properly qualified installation engineers and highly qualified installers and technicians, fully trained for the product, are authorised to install and start-up the equipment safely.

During all servicing operations, all instructions and recommendations, which appear in the installation and service instructions for the product, as well as on tags and labels fixed to the equipment and components and accompanying parts supplied separately, must be read, understood and followed.

Apply all standard safety codes and practices.

Wear safety glasses and gloves.

Use the proper tools to move heavy objects. Move units carefully and set them down gently.

1.2 Avoid electrocution

Only personnel qualified in accordance with IEC (International Electrotechnical Commission) recommendations may be permitted access to electrical components. It is particularly recommended that all sources of electricity to the unit be shut off before any work is begun. Shut off main power supply at the main circuit breaker or isolator.

IMPORTANT: This equipment uses and emits electromagnetic signals. Tests have shown that the equipment conforms to all applicable codes with respect to electromagnetic compatibility.



RISK OF ELECTROCUTION: Even when the main circuit breaker or isolator is switched off, certain circuits may still be energized, since they may be connected to a separate power source.



RISK OF BURNS: Electrical currents cause components to get hot either temporarily or permanently. Handle power cable, electrical cables and conduits, terminal box covers and motor frames with great care.



ATTENTION: In accordance with the operating conditions the fans can be cleaned periodically. A fan can start at any time, even if the unit has been shut down.

1.3 Safety Devices

Each unit is equipped with safety devices of three different kinds:

1.3.1 General safety devices

Safeties of this level of severity will shut down all the circuits and stop the entire unit. When a general safety device will occur a manual intervention on the unit will be required in order to re-establish the normal operability of the machine. There are exceptions to this general rule in case of alarms linked to temporary abnormal conditions.

- Emergency Stop

A push button is placed on a door of the unit electrical panel. The button is highlighted by a red color in yellow background. A manual pressure of the emergency stop button stops all loads from rotating, thus preventing any accident which may occur. An alarm is also generated by the Unit Controller. Releasing the emergency stop button enables the unit, which may be restarted only after the alarm has been cleared on the controller.



The emergency stop causes all motors to stop, but does not switch off power to the unit. Do not service or operate on the unit without having switched off the main switch.

1.3.2 Circuit safety devices

Safety of this level of severity will shut down the circuit they protect. The remaining circuits will keep running.

1.3.3 Component safety devices

Safety of this level of severity will shut down a component against abnormal running condition that could create permanent damages to it. An overview of the protecting devices is listed below:

- Overcurrent/Overload Protections

Overcurrent/overload devices protect electrical motors used on compressors, and pumps in case of overload or short circuit. In case of inverter-driven motors, overload and overcurrent protection is integrated in the electronic drives. A further protection from short circuit is accomplished by fuses or circuit breakers installed upstream each load or group of loads.

- Overtemperature Protections

Compressors are also protected from overheating by thermistors immersed into motor windings. Should the winding temperature exceed a fixed threshold, the thermistors will trip and cause the motor to stop.

- Phase reversal, under/over voltage, ground fault protections

When one of those alarms occurs the unit is immediately stopped or even inhibited to start. The alarms clear automatically once the problem is fixed. This auto clear logic allows the unit to automatically recover in case of temporary conditions where the supply voltage reaches the upper or lower limit set on the protection device. In the other two cases a manual intervention

on the unit will be required in order to solve the problem. In case of a phase reversal alarm two phases requires to be inverted.

In the event of a power supply outage, the unit will restart automatically without the need for an external command. However, any faults active when the supply is interrupted are saved and may in certain cases prevent a circuit or unit from restarting.



Direct intervention on the power supply can cause electrocution, burns or even death. This action must be performed only by trained persons.

- Flowswitch

The unit must be protected by a flowswitch. The flowswitch will stop the unit when the water flow becomes lower than the minimum allowed flow. When the water flow is restored the flow protection resets automatically. Exception is when the flowswitch opens with at least one compressor running, in this case the alarm shall be cleared manually.

- Freezing protection

Antifreeze protection prevents the water to freeze in the evaporator. It is automatically activated when the water temperature (entering or leaving) at the evaporator drops below the antifreeze limit. In freeze condition if the unit is in standby the evaporator pump will be activated to prevent freezing of the evaporator. If the freeze condition will activate when the unit is running all the unit will shut down in alarm while the pump will keep running. Alarm will automatically clear when the freeze condition will clear.

- Low pressure protection

If the circuit operates with a suction pressure lower than an adjustable limit for a certain time the circuit safety logic will shut down the circuit and generate an alarm. The alarm requires a manual action on the Unit Controller to be reset. Reset will take effect only if the suction pressure is no longer lower than the safety limit.

- High Pressure Protection

If the discharge pressure becomes too high and exceeds a limit which is linked with the operational envelop of the compressor the circuit safety logic will try to prevent the alarm or, if the corrective actions have no effect, it will shut down the circuit before the Mechanical High Pressure switch will open. This alarm required a manual action on the Unit Controller to be reset.

- Mechanical High Pressure Switch

Each circuit is equipped with at least one high pressure switch which tries to prevent the relief safety valve to open. When the discharge pressure becomes too high the Mechanical High Pressure switch will open and immediately stop the compressor cutting the power supply to the auxiliary relay. The alarm can be cleared as soon as the discharge pressure becomes normal

again. The alarm must be reset on the switch itself and on the Unit Controller. The triggering pressure value cannot be changed.

- Relief Safety Valve

If the pressure becomes too high in the refrigerant circuit, the relief valve will open to limit the maximum pressure. If this happens switch off immediately the machine and contact your local service organization.

1.4 Available sensors

1.4.1 Pressure transducers

Two electronic sensors are used to measure the evaporating and condensing pressure of each circuit. The range of each sensor is clearly indicated on the sensor casing.

1.4.2 Temperature sensors

The evaporator and condenser water sensors are installed in the entering and leaving side. Additionally each circuit installs a suction temperature sensor to monitor and control the superheated refrigerant temperatures.

1.4.3 Thermistors

Each compressor is equipped with PTC thermistors which are immersed into motor windings for motor protection. Thermistors trip to a high value in case the motor temperature reaches a hazardous temperature.

1.5 Available Controls

In the following the different functions will be distinguished between Water Cooled (W/C) and Air Cooled (A/C) units and Cooling Only (C/O) and Heat Pumps (H/P). If not specified one specific function can apply to any W/C unit independently from being a C/O or H/P unit.

1.5.1 Evaporator - Condenser pumps

The controller can regulate one or two evaporator pumps and takes care of automatic change-over between pumps. It's also possible to prioritize the pumps and temporarily disable one of the twos.

The controller can also regulate an unique condenser water pump (W/C units only).

1.5.2 Compressors

The controller can regulate two or four compressors installed on one or two independent refrigerant circuit. All the safeties of each compressor will be managed by the controller.

1.5.3 Expansion Valve

The controller can regulate an electronic expansion valve per each refrigerant circuit to guarantee the best operation for the refrigerant circuit.

1.5.4 Four Way Valve

The controller can command a four way valve per each refrigerant circuit where required. The valve is used to reverse the unit mode from Cool to Heat.

1.6 Abbreviations used

In this manual, the refrigeration circuits are called circuit #1 and circuit #2.

The following abbreviations are used frequently:

UC	Unit controller
HMI	Human Machine Interface
A/C	Air Cooled
W/C	Water Cooled
C/O	Cooling Only
H/P	Heat Pump
CL	Condenser Less
CP	Condensing Pressure
EP	Evaporating Pressure
CSRT	Condensing Saturated Refrigerant Temperature
ESRT	Evaporating Saturated Refrigerant Temperature
ST	Suction Temperature
SSH	Suction SuperHeat
EXV	Electronic Expansion Valve
ELWT	Evaporator Leaving Water Temperature
EEWT	Evaporator Entering Water Temperature
CLWT	Condenser Leaving Water Temperature
CEWT	Condenser Entering Water Temperature

1.7 Customer Terminal Block Connections

1.7.1 Connections description and purpose

The contacts below are available at the user's terminal block referred as MC24 or MC230 in the wiring diagram. The following table summarizes the connections at the user's terminal block.

Description	Terminals	Notes
Evaporator Flow Switch (mandatory)	724, 708	For potential-free contacts Sampling voltage / current DC 24 V / 8 mA
Condenser Flow Switch (W/C mandatory)	794, 793	For potential-free contacts Sampling voltage / current DC 24 V / 8 mA
Cooling/Heating Remote switch (H/P units only)	743,744	For potential-free contacts Sampling voltage / current DC 24 V / 8 mA
Double setpoint	713,709	For potential-free contacts Sampling voltage / current DC 24 V / 8 mA
External Fault	884, 885	For potential-free contacts Sampling voltage / current DC 24 V / 8 mA
On-Off Remote	741, 742	For potential-free contacts Sampling voltage / current DC 24 V / 8 mA
General Alarm	525, 526	NO digital output (24...230 Vac ext supply)
Evaporator Pump #1 start	527,528	NO digital output (24...230 Vac ext supply)
Evaporator Pump #2 start (A/C only)	530, 531	NO digital output (24...230 Vac ext supply)
Evaporator Pump #2 start (W/C only)	893,894	NO digital output (24 Vdc - 25mA)

Condenser Pump #1 start (W/C only)	520,521	NO digital output (24...230 Vac ext supply)
Condenser Pump #2 start (W/C only)	540,541	NO digital output (24...230 Vac ext supply)
Demand Limit	888, 889	4-20 mA analog input
Setpoint Override	886, 887	4-20 mA analog input
Condenser three way valve (W/C only)	772, 773	0-10V analog output
Condenser tower fan speed (W/C only)	772, 774	0-10V analog output
Master/Slave Water Temperature	890, 896	NTC10K / PT1000 temperature sensor
Master/Slave Bus Connection	900, 901	Serial communication

1.7.1.1 Flow Switch

Although the flow switch is offered as an optional, it is mandatory to install one and connect it to the digital input terminals in order to enable chiller operation only when a minimum flow is sensed.



Operating the unit by-passing the flow switch input or without an appropriate flow switch may damage the water heat exchanger due to freezing. Operation of the flow switch must be checked prior to start up the unit.

1.7.1.2 Double setpoint

This contact can be used to switch between two different LWT setpoints and, depending on the application, between different modes of operation.

Ice operation must be selected in case of ice storage application. In this case the UC will run the chiller in on/off mode switching all the chiller off as soon as the setpoint is reached. In this case the unit will run to full capacity and then will switch off applying an ice delay different chiller starts.

1.7.1.3 External Fault (optional)

This contact is available to report to the UC a fault or a warning from an external device. It could be an alarm coming from an external pump to inform the UC of the fault. This input can be configured as a fault (unit stop) or a warning (displayed on the HMI without any action on the chiller).

1.7.1.4 Remote On-Off

This unit can be started through a remote enable contact. The Q0 switch must be selected to "Remote".

1.7.1.5 General Alarm

In case of a unit alarm, this output is closed thus indicating a fault condition to an externally connected BMS.

1.7.1.6 Evaporator Pump Start

Two digital outputs are enabled when the pumps (#1 or #2) are required to start. The output for the pump #2 requires a relay with less than 20 mA excitation current.

1.7.1.7 Setpoint override (optional)

This input allows to apply an offset on the Active Setpoint to adjust the operating point of the ELWT. This input can be used to maximize the comfort.

1.7.1.8 Demand Limit (optional)

This input allows to limit the maximum number of compressor in run state.

2 GENERAL DESCRIPTION

2.1 Overview

The UC is a system for controlling single or dual-circuit W/C and A/C liquid chillers / heat-pump. The UC controls compressor start-up necessary to maintain the desired heat exchanger leaving water temperature.

On W/C units the UC can optionally controls a three way valve or a cooling tower to perform a condensing control. One of the following three variables can be selected as condensing target:

- Condenser leaving water temperature (W/C only)
- Condenser entering water temperature (W/C only)
- Condensing saturated refrigerant temperature

Safety devices are constantly monitored by the UC to ensure their safe operation. UC also gives access to a Test routine covering all inputs and outputs. The controller can work in accordance with three independent modes:

- Local mode: the machine is controlled by commands from the user interface.
- Remote mode: the machine is controlled by remote contacts (volt-free contacts).
- Network mode: the machine is controlled by commands from a BAS system. In this case, a data communication cable is used to connect the unit to the BAS.

When the UC operates autonomously (Local or Remote mode) it retains all of its own control capabilities but does not offer any of the command features of the Network mode (monitoring only).

2.2 Controller Operating Limits

Operation (IEC 721-3-3):

- Temperature -40...+70 °C
- Restriction LCD -20... +60 °C
- Restriction Process-Bus -25....+70 °C
- Humidity < 90 % r.h (no condensation)
- Air pressure min. 700 hPa, corresponding to max. 3,000 m above sea level

Transport (IEC 721-3-2):

- Temperature -40...+70 °C
- Humidity < 95 % r.h (no condensation)
- Air pressure min. 260 hPa, corresponding to max. 10,000 m above sea level.

2.3 Controller Architecture

The overall controller architecture is the following:

- A unit controller (UC)
- I/O extensions as needed depending on the configuration of the unit
- Communications interface(s) as selected

- Peripheral Bus is used to connect I/O extensions to the main controller.

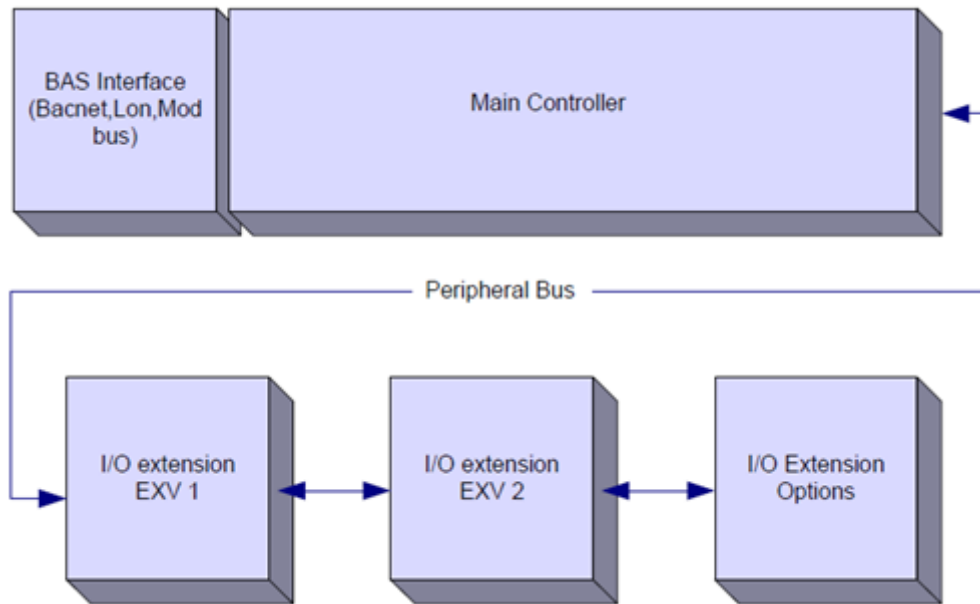

Controller/ Extension Module	Siemens Part Number	Address	Usage
Main Controller	POL638.00/MCQ	n/a	Used on all configurations
EEXV Module 1	POL94E.00/MCQ	3	Used on all configurations
EEXV Module 2	POL94E.00/MCQ	5	Used when configured for 2 circuits
Option Module	POL965.00/MCQ	18	Used when options required

All boards are supplied from a common 24 Vac sourced directly from the unit. Extension boards can be directly powered by the Unit Controller. All boards can be also supplied by a 24Vdc source. These are the limits for the two different power supplies available:

- AC: 24V ± 20% (frequency 45 ÷ 65Hz)
- DC: 24V ± 10%



Maintain the correct G-G0 polarity when connecting the power supply directly to the extension boards. The peripheral bus communication will not operate and the boards may be damaged.

2.4 Communication Modules

Any of the following modules can be connected directly to the left side of the main controller to allow a BAS or other remote interface to function. Up to three can be connected to the controller at a time. To make the connection is required to remove the knockout covers on both UC and communication module as shown in the following pictures.



The controller should automatically detect and configure itself for new modules after booting up. Removing modules from the unit will require manually changing of the configuration.

Module	Siemens Part Number	Usage
BacNet/IP	POL908.00/MCQ	Optional
Lon	POL906.00/MCQ	Optional
Modbus	POL902.00/MCQ	Optional
BACnet/MSTP	POL904.00/MCQ	Optional

Separate documents contains all the information about the different protocols supported and how to setup a proper communication with a BMS.

2.4.1 Modbus Module installation

In case of Modbus connection with a BMS the corresponding module has to be installed on the unit. It has to be connected to the Unit Controller as indicated in the previous section.



The module has two different ports available but only the top port is programmed and operational. A dedicated menu allows to properly setup the communication parameters.

2.4.2 Bacnet Module installation

In case of Bacnet connection with a BMS, there are two different modules available depending on the physical connection to the customer network. The two possible connections are IP or MSTP.



A dedicated menu allows to properly setup the communication parameters.

2.4.3 Lon Module installation

In case of Lon connection with a BMS, there are two different modules available depending on the physical connection to the customer network. The type of connection is FTT10.



A dedicated menu allows to properly setup the communication parameters.

3 Using the Controller

The control system consists of a unit controller (UC) equipped with a set of extension modules that implement additional features. All boards communicate via an internal peripheral bus with the UC. The UC continuously manages the information received from the various pressure and temperature probes installed on the unit. The UC incorporates a program that controls the unit.

Two different types of UC HMI are available as standard HMI:

1. Inbuilt HMI (A/C units)

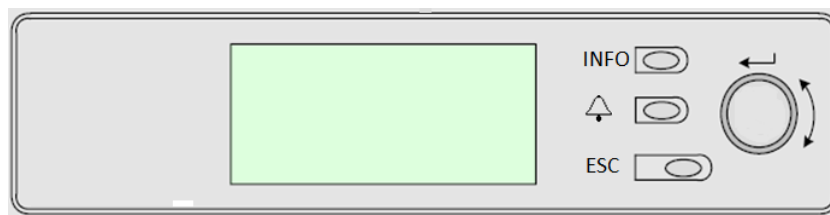

This HMI is provided of three buttons and one wheel button.

	Alarm status (from any page it links with the page with alarm list, alarm log and alarm snapshot if available)
INFO	Back to Main Page
ESC	Back to the previous level (it can be the Main Page)
Wheel Button	Used to scroll between the different menu pages, settings and data available on the HMI for the active password level. Rotating the wheel allows to navigate between lines on a screen (page) and to increase and decrease changeable values when editing. Pushing the wheel acts as an Enter Button and will jump from a link to the next set of parameters.

2. External HMI (POL871.72) (W/C units)

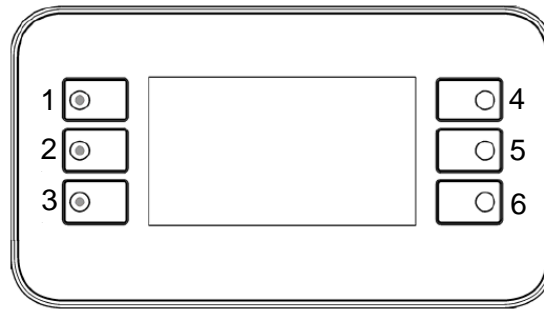

This External HMI is provided of six buttons.

1		Back to Main Page
2		Alarm status (from any page it links with the page with alarm list, alarm log and alarm snapshot if available)
3		Back to the previous level (it can be the Main Page)
4		Go above
5		Go below
6		Confirm

3.1 General Recommendation

Before switching on the unit read the following recommendations:

- When all the operations and all the settings have been carried out, close all the switchbox panels
- The switchbox panels can only be opened by trained personnel
- When the UC requires to be accessed frequently the installation of a remote interface is strongly recommended
- Compressor are protected from freezing by electrical heaters. These heaters are supplied through unit main supply and temperature controlled by thermostat.
- the LCD display of the unit controller may be damaged by extremely low temperatures. For this reason, it is strongly recommended to never power off the unit during winter, especially in cold climates.

3.2 Browsing

When power is applied to the control circuit, the HMI screen will be active and display the Home screen.

An example of the HMI screens is shown in the following picture.

Main Menu	1 / 11
Enter Password	
Unit Status =	
Off: Unit SW	
Active Setpt =	7.0 °C

In the inbuilt HMI a ringing bell in the top right corner will indicate an active alarm, If the bell doesn't move it means that the alarm has been acknowledged but not cleared because the alarm condition hasn't been removed.

Same alarm indication is performed by the LED of the button 2 of the external HMI.

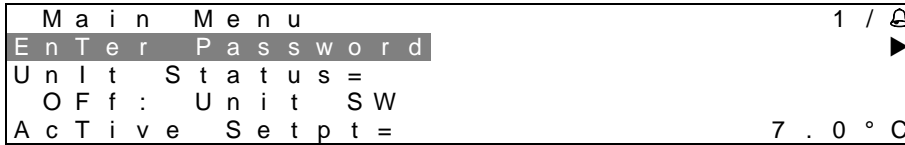

The active item is highlighted in contrast, in this example the item highlighted in Main Menu is a link to another page. By pressing the button 6, the HMI will jump to a different page. In this case the HMI will jump to the Enter Password page.

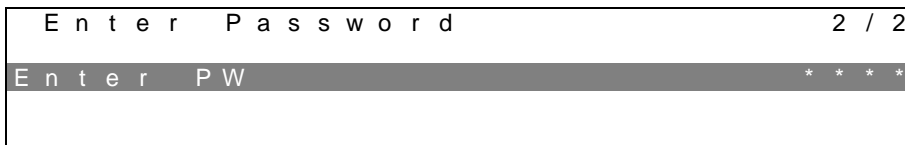

3.3 Passwords

The HMI structure is based on access levels that means that each password will disclose all the settings and parameters allowed to that password level. Basic information about the status including the active alarm list, active setpoint and controlled water temperature can be accessed without the need to enter the password.

The UC handles two level of passwords:

USER	5321
MAINTENANCE	2526

The following information will cover all data and settings accessible with the maintenance password. User password will disclose a subset of the settings explained in chapter 4.

In the Enter Password screen, the line with the password field will be highlighted to indicate that the field on the right can be changed. This represents a setpoint for the controller. Pressing the wheel or button 6 the individual field will be highlighted to allow an easy introduction of the numeric password. By changing all fields, the 4 digits password will be entered and, if correct, the additional settings available with that password level will be disclosed.

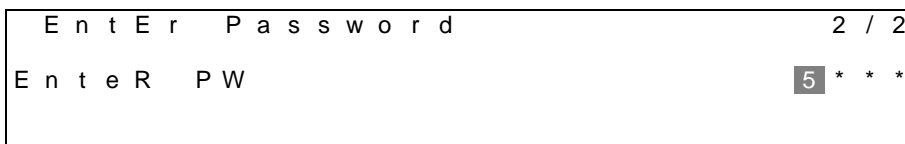

The password will time out after 10 minutes and is cancelled if a new password is entered or the control powers down. Entering an invalid password has the same effect as continuing without a password.

Once a valid password has been entered, the controller allows further changes and access without requiring the user to enter a password until either the password timer expires or a different password is entered. The default value for this password timer is 10 minutes.

3.4 Editing

Only line with highlighted value field can be edited, through the right buttons it is possible selected and modify the value.

A parameter with an “R” is read only; it is giving a value or description of a condition. An “R/W” indicates a read and/or write opportunity; a value can be read or changed (providing the proper password has been entered).

Example 1: Check Status, for example -is the unit being controlled locally or by an external network? We are looking for the Unit Control Source since this a unit status parameter, start at Main Menu and select View/Set Unit and press the wheel or button 6 to jump to the next set of menus. There will be an arrow at the right side of the box, indicating that a jump to the next level is required.

In the new page rotate the wheel or use button 4/5 to highlight the Network Ctrl and press the wheel or the button 6 again to jump to the next menu where it is possible read the actual Control Source.

Example 2: Change a Set point, the chilled water set point for example. This parameter is designated as Cool LWT Set point 1 and is a unit set parameter. From the Main Menu select Active Setpt. The arrow indicated that there is a link to a further menu.

Press the wheel or button 6 and jump to the temperature setpoint page. Select Cool LWT 1 and press the wheel or button 6 to jump to the item change page. Rotate the wheel or use buttons 4 / 5 to adjust the set point to the desired value. When this is done press the wheel or button 6 again to confirm the new value. With the button ESC or 3 it will be possible to jump back to the main menu where the new value will be displayed.

Example 3: Clear an Alarm,. The presence of a new alarm is indicated with a Bell ringing on the top right of the display. If the Bell is frozen one or more alarm had been acknowledged but are still active. To view the Alarm menu from the Main Menu scroll down to the Alarms line. Note the arrow indicating this line is a link. Press the button 6 to jump to the next menu Alarms. There are two lines here; Alarm Active and Alarm Log. Alarms are cleared from the Active Alarm link. Press the button 6 to jump to the next screen. When the Active Alarm list is entered scroll to the item AlmClr which is set to off by default. Change this value to on to acknowledge the alarms. If the alarms can be cleared then the alarm counter will display 0 otherwise it will display the number of alarm still active. When the alarms are acknowledged the Bell on the top right of the display will stop to ring if some of the alarms are still active or will disappear if all the alarms are cleared.

3.5 Basic Control System Diagnostic

Unit controller, extension modules and communication modules are equipped with two status LED (BSP and BUS) to indicate the operational status of the devices. The BUS LED indicates the status of the communication with the controller. The meaning of the two status LED is indicated below.

UC BSP LED

BSP LED	Mode
Solid Green	Application running
Solid Yellow	Application loaded but not running (*) or BSP Upgrade mode active
Solid Red	Hardware Error (*)
Flashing Green	BSP startup phase. The controller needs time for starting.
Flashing Yellow	Application not loaded (*)
Flashing Yellow/Red	Fail safe mode (in case that the BSP upgrade was interrupted)
Flashing Red	BSP Error (software error*)
Flashing Red/Green	Application/BSP update or initialization

(*) Contact Service.

Extension modules

BSP LED

BSP LED	Mode
Solid Green	BSP running
Solid Red	Hardware Error (*)
Flashing Red	BSP Error (*)
Flashing Red/Green	BSP upgrade mode

BUS LED

BUS LED	Mode
Solid Green	Communication running, I/O working
Solid Yellow	Communication running but parameter from the application wrong or missing, or uncorrect factory calibration
Solid Red	Communication down (*)

Communication modules

BSP LED (same for all modules)

BSP LED	Mode
Solid Green	BPS running, communication with controller
Solid Yellow	BSP running, no communication with controller (*)
Solid Red	Hardware Error (*)
Flashing Red	BSP Error (*)
Flashing Red/Green	Application/BSP update

(*) Contact Service.

LON module BUS LED

BUS LED	Mode
Solid Green	Ready for Communication. (All Parameter loaded, Neuron configured). Doesn't indicate a communication with other devices.
Solid Yellow	Startup
Solid Red	No Communication to Neuron (internal error, could be solved by downloading a new LON application)
Flashing Yellow	Communication not possible to the Neuron. The Neuron must be configured and set online over the LON Tool.

Bacnet MSTP BUS LED

BUS LED	Mode
Solid Green	Ready for Communication. The BACnet Server is started. It doesn't indicate a active communication
Solid Yellow	Startup
Solid Red	BACnet Server down. Automatically a restart after 3 seconds are initiated.

Bacnet IP BUS LED

BUS LED	Mode
Solid Green	Ready for Communication. The BACnet Server is started. It doesn't indicate a active communication
Solid Yellow	Startup. The LED stays yellow until the module receives a IP Address, therefore a link must be established.
Solid Red	BACnet Server down. Automatic restart after 3 seconds is initiated.

Modbus BUS LED

BUS LED	Mode
Solid Green	All Communication running
Solid Yellow	Startup, or one configured channel not communicating to the Master
Solid Red	All configured Communications down. Means no communication to the Master. The timeout can be configured. In case that the timeout is zero the timeout is disabled.

3.6 Controller maintenance

The UC requires to maintain the installed battery. Battery model is: BR2032 and it is produced by many different vendors.



On board real time clock settings are maintained thanks to a battery mounted on the controller. Make sure that the battery is replaced regularly each 2 years.



Battery is only used to supply the onboard real time clock. All the other settings are retained in a non volatile memory.

To replace the battery gently remove the plastic cover of the controller display using a screw driver as shown in the following pictures:

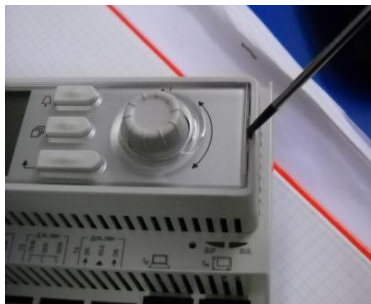

Be careful to avoid damages to the plastic cover. The new battery shall be placed in the proper battery holder which is highlighted in the following picture, respecting the polarities indicated into the holder itself.



3.7 Software Update procedure

UC can be updated by using an SD card and an appropriate pin.



Actual BSP and software version installed on UC can be checked in the About Chiller page.



SD card has to be FAT32 formatted before any update process can be started. Supported SD types are:

- SD standard
- High speed SD
- SDHC

The following SD cards have also been tested and found operational:

- 1 GByte SD V1.0 (Inmac)
- 2 GByte SD V2.0 SpeedClass 2 (SanDisk),
- 4 GByte SDHC V2.0 SpeedClass 6 (Hama High Speed Pro),
- 4 GByte SDHC V2.0 SpeedClass 4 (SanDisk Ultra II),
- 8 GByte micro SDHC SpeedClass 4 (Kingston)

In case an update is received all the files included in the archive are to be saved in the SD card with their original name. The standard software pack is composed with 6 files:

1. BSP file (operative system of the UC),
2. Code file,
3. HMI file,
4. OBH file (multilingual and protocol support),
5. HMI for Web (web interface),
6. Cloud file.



The software for this specific range of units cannot be used with the Large UCs (POL687.xx/MCQ) used on other products. In case of doubts, please contact your Daikin Service reference.

Before proceeding is required to disable the unit using the Q0 switch and perform a normal shutdown procedure.

To install the software, take care to make a copy of the controller settings on the SD card by using the Save/Restore menu (see Save and Restore menu for details).

Remove power to the controller using the Q12 switch and insert the SD card in its slot as shown in the picture with the contact strips looking toward you.

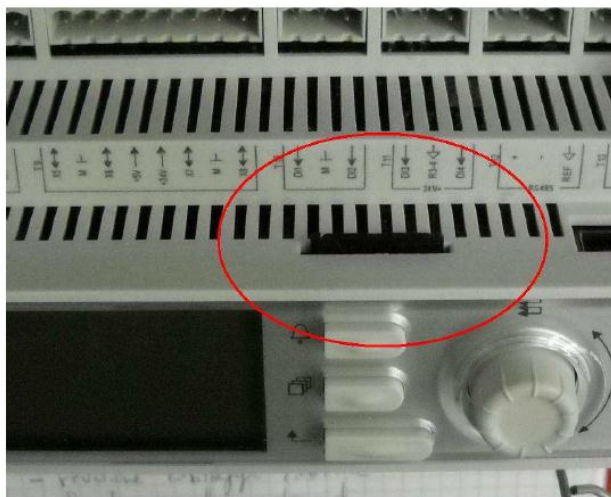

Once this is done, insert the pin in the reset hole, gently push the service microswitch and keep it pressed until the update process is initiated.

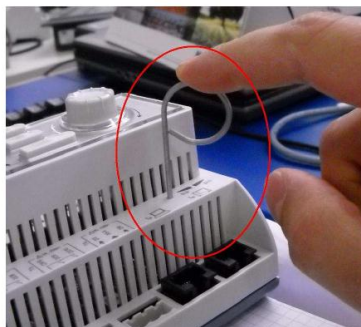

Service microswitch is an electronic component. An excessive pressure on the service microswitch can permanently damage the UC. Please take care of not exceed with your strength to avoid damages to your unit.

With the service microswitch pressed, re-establish the power to the controller using the Q12 switch. After a short while the BSP led on the UC will start to blink between green and off. When this happen release the service microswitch and wait for the update process to start. Update process is indicated by the BSP led blinking between green and red.



In case of BSP update the BSP led will stop in off. If this happen the update process has to be repeated once more. If the BSP led will stop in yellow color the process is completed and the controller restarted.

After the controller is restarted the BSP led will blink green during the boot up and then it will remain solid green to indicate normal operations. It's now possible to restore the previous settings if available and restart the unit.

3.8 Optional Remote User Interface

As an option an external Remote HMI can be connected on the UC. The Remote HMI offers the same features as the inbuilt display plus the alarm indication done with a light emitting diode located below the bell button.

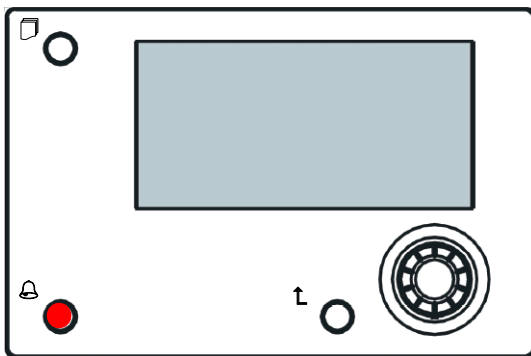

The Remote interface can be ordered with the unit and shipped loose as a field installed option. It can also be ordered anytime after chiller shipment, mounted and wired on the job site as explained in the following.



The remote panel is powered directly from the UC. No additional power supply is required.

All views, data and setpoint adjustments available on the UC HMIs are available on the remote panel. Navigation is identical to the UC as described in this manual.

The initial screen when the remote is turned on shows the units connected to it. Highlight the desired unit and press the wheel to access it. The remote will automatically show the units attached to it, no initial entry is required.



Long press of the ESC button will show the list of the connected controllers. Use the wheel to select the desired controller.

The Remote HMI can be extended up to 700m using the process bus connection available on the UC. With a daisy-chain connection as below, a single HMI can be connected to up to 8 units. Refer to the specific HMI manual for details.

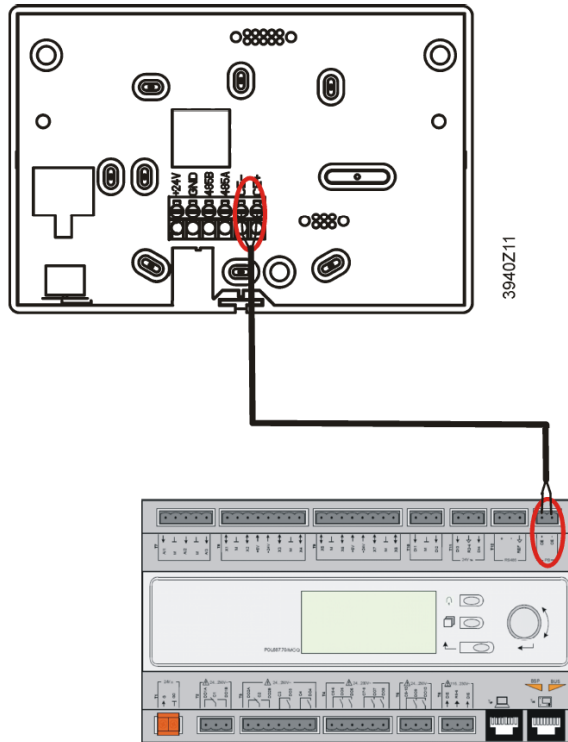
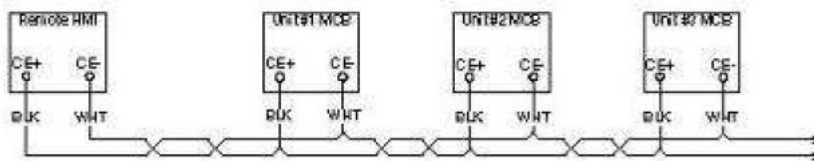

The Remote interface can be also connected with an Ethernet cable (twisted pair). Maximum length can change depending on the cable characteristic:

- Shielded cable: max length 50m,
- Non shielded cable: max length 3m.

Connection in this case has to be executed as shown in the following image.

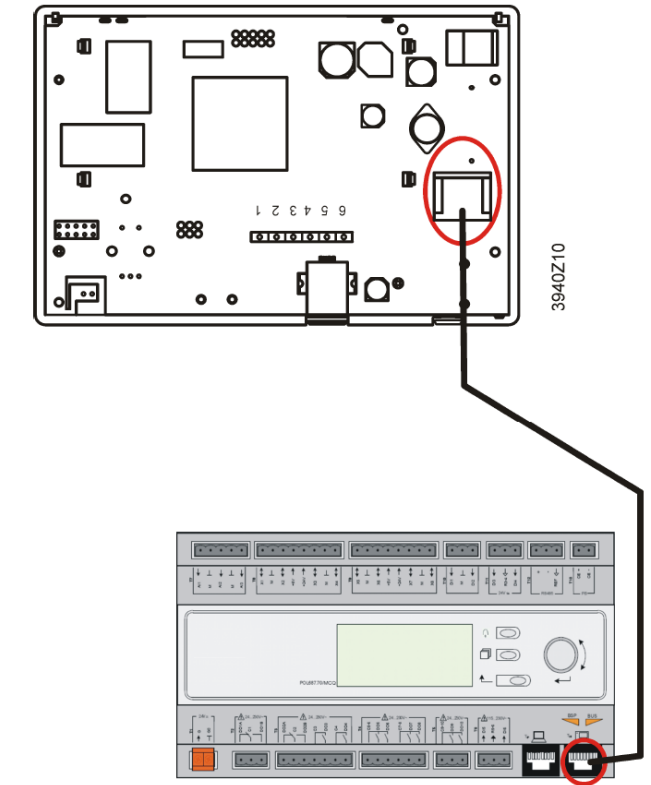

3.9 Embedded Web Interface

The unit controller has an embedded web interface that can be used to monitor the unit when connected to a local network. It is possible to configure the IP addressing of the controller as a fixed IP or DHCP depending on the network configuration.

With a common web browser a PC can connect with the unit controller entering the IP address of the controller or the host name, both visible in the “About Chiller” page accessible without entering a password.

When connected it will be required to enter a user name and a password as shown in the picture below:

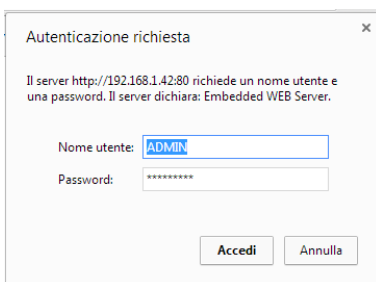

Enter the following credential to get access to the web interface:

User Name: ADMIN
Password: SBTAdmin!

The following page will be displayed:

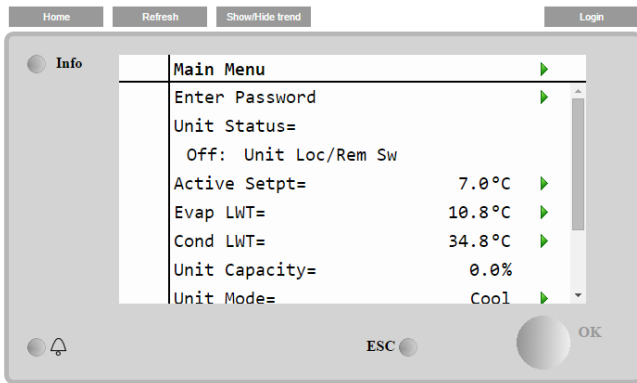

The page is a copy of the onboard HMI and follows the same rules in terms of access levels and structure.

In addition it allows to trend log a maximum of 5 different quantities. It's required to click on the value of the quantity to monitor and the following additional screen will become visible:

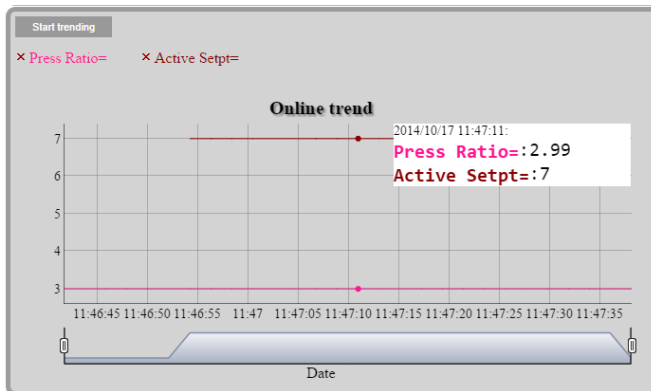

More than one page can be opened at the same time. This can allow to monitor more trends of different tabs.

Depending on the web browser and its version the trend log feature may not be visible. It's required a web browser supporting HTML 5 like for example:

- Microsoft Internet Explorer v.11,
- Google Chrome v.37,
- Mozilla Firefox v.32.

These software are only an example of the browser supported and the versions indicated have to be intended as minimum versions.

4 Menu Structure

All settings are divided in different menus. Each menu collects in a single page other sub-menus, settings or data related to a specific function (for example Power Conservation or Setup) or entity (for example Unit or Circuit). In any of the following pages a grey box will indicate changeable values and the defaults.

4.1 Main Menu

Setpoint/Sub-Menu	Default	Range	Description
Enter Password	▶	-	Submenu to activate access levels
View/Set Unit	▶	-	Submenu for unit data and settings
View/Set Circuit	▶	-	Submenu for circuit data and settings
Unit Status=	Off: Unit Loc/Rem Sw	Auto Off: Ice Mode Tmr Off: All Cir Disabled Off: Unit Alarm Off: Keypad Disable Off: BAS Disable Off: Unit Loc/Rem Sw Off: Test Mode Auto: Wait For Load Auto: Evap Recirc (A/C only) Auto: Water Recirc (W/C only) Auto: Wait For Flow Auto: Pumpdn Auto: Max Pull Limited Auto: Unit Cap Limit Off: Cfg Chg, Rst Ctrl	Status of the Unit
Active Setpt=	7.0°C ▶	-	Active setpoint and link to the Setpoint page (see section 4.3.1.5 for more details).
Evap LWT=	-273.1°C ▶	-	Evaporator leaving water temperature and link to the Temperatures page (see section 4.5 for more details).
Cond LWT=	-273.1°C ▶	-	Condenser leaving water temperature and link to the Temperatures page (W/C only).
Unit Capacity=	0.0%	-	Actual unit capacity.
Chiller Enable=	Enable	Enable-Disable	Chiller operation enable/disable setting.
Unit Mode=	Cool ▶	-	Actual unit mode and link to unit available mode selection page (see section 4.6 for more details).
Timers	▶	-	Submenu compressors and thermoregulation safety timers (see section 4.7 for more details).
Alarms	▶	-	Submenu for alarms; same function as Bell Button (see section 0 for more details)
Commission Unit	▶	-	Submenu for the chiller configuration (see section 0 for more details).
Save and Restore			Submenu to the Save and Restore page (see section
About Chiller	▶	-	Application Info submenu (see section 0 for more details).

4.2 View/Set Unit

Setpoint/Sub-Menu	Default	Range	Description
Thermostat Ctrl	▶	-	Submenu Thermoregulation control parameter
Network Ctrl	▶	-	Submenu Network Control
Unit Cond Ctrl	▶	-	Submenu Unit Condensing Control (W/C only)
Pumps	▶	-	Submenu Pumps control and data
Master/Slave	▶	-	Submenu Master Slave
Date/Time/Schedule	▶	-	Submenu Date, Time and Quiet Night mode schedule
Power Conservation	▶	-	Submenu Unit Limiting functions
Modbus Setup	▶	-	Submenu Setup of Modbus communication
Bacnet IP Setup	▶	-	Submenu Setup of Bacnet IP communication
Bacnet MSTP Setup	▶	-	Submenu Setup of Bacnet MSTP communication
LON Setup	▶	-	Submenu Setup of LON communication
Ctrlr IP Setup	▶	-	Submenu IP settings for on-board web-server
Cloud Connection	▶	-	Submenu Cloud Connection

4.2.1 Thermostat Ctrl

This page resumes all thermoregulation parameters. For more details about this parameters and the thermoregulation logic see section 5.1.4.

Setpoint/Sub-Menu	Default	Range	Description
Start Up DT=	2.7°C	0.0...5.0°C	Offset respect the active setpoint for unit start.
Shut Dn DT=	1.5°C	0.0...5.0°C	Offset respect the active setpoint for unit shutdown
Stage DT=	1.0°C	0.0...Start Up DT°C	Offset respect the active setpoint for unit stage up and down
Max PullDn=	1.7°C/min	0.1...2.7°C/min	Max pull down rate of controlled water temperature
Max PullUp=	1.7°C/min	0.1...2.7°C/min	Max pull up rate of controlled water temperature
Stg Up Delay=	2min	0...8min	Compressor start inter-stage delay
Stg Dn Delay=	30sec	20...60sec	Compressor stop inter-stage delay
Strt Strt Dly=	10min	10...60min	Compressor Start to Start delay
Stop Strt Dly=	3min	3...20min	Compressor Stop to Start delay
Ice Cycle Dly=	12h	1...23h	Ice cycle delay
OAT En Bckp Htr=	-3.0°C	-20.0...5°C	Outside Air Temperature to enable the backup heater logic (see section 5.4)

4.2.2 Network Ctrl

This page resumes all settings (unit on/off, unit mode, temperature setpoint, capacity limit) set by BMS when the unit is controlled from network.

Setpoint/Sub-Menu	Default	Range	Description
Control Source=	Local	Local, Network	Determines whether on/off, cooling/heating/ice setpoint, operation mode, capacity limit, should be commanded by local (HMI) settings or from BMS
Netwrk En SP=	-	-	Unit enable from BMS
Netwrk Mode SP=	-	-	Unit mode from BMS
Netwrk Cool SP=	-	-	Cooling setpoint from BMS
Netwrk Heat SP=	-	-	Heating setpoint from BMS
Netwrk Cap Lim=	-	-	Capacity limitation from BMS
Netwrk Ice SP=	-	-	Ice setpoint from BMS

4.2.3 Unit Cond Ctrl (W/C only)

This page resumes all settings for the unit condensing control. For more details about this parameters and the unit condensing control logic see section 5.6.2

Setpoint/Sub-Menu	Default	Range	Description
Cnd SP Clg=	35°C	20...55°C	Condenser setpoint for cooling mode
Cnd SP Htg=	10°C	-10...20°C	Condenser setpoint for heating mode
Cnd Act Sp=	-	-	Active condensing temperature setpoint
Cnd Ctrl Tmp=	-	-	Condensing control temperature
Output=	-	-	Actual condensing control output
Max Output=	100%	50...100%	Maximum condensing control output

Min Output	0%	0...50%	Minimum condensing control output
------------	----	---------	-----------------------------------

4.2.4 Pumps

This page resumes all setting for the water pumps management. For more details about this parameters and the pump control logic refer to section 0.

Setpoint/Sub-Menu	Default	Range	Description
Evap Pmp Ctrl=	#1 Only	#1 Only #2 Only Auto #1 Primary #2 Primary	Set number of evaporator pumps operational and their priority
Cond Pmp Ctrl=	#1 Only	#1 Only #2 Only Auto #1 Primary #2 Primary	Set number of condenser pumps operational and their priority (W/C only)
Recirc Tm=	30s	15...300s	Recirculation water timer
Evap Pmp 1 Hrs=	0h		Running Hours Evaporator Pump 1 (if present)
Evap Pmp 2 Hrs=	0h		Running Hours Evaporator Pump 2 (if present)
Cond Pmp 1 Hrs	0h		Running Hours Condenser Pump 1 (if present W/C only)
Cond Pmp 2 Hrs=	0h		Running Hours Condenser Pump 2 (if present W/C only)

4.2.5 Master/Slave

This page resumes all submenus for the configuration and monitoring of the Master Slave function. For more details refer to section 5.10

Setpoint/Sub-Menu	Default	Range	Description
Standby Chiller	▶	-	Submenu Standby Chiller
Options	▶	-	Submenu Options
Thermostat Ctrl	▶	-	Submenu Thermostat Ctrl
Data	▶	-	Submenu Data
Timers	▶	-	Submenu Timers
Disconnect Unit	No	No, Yes	Parameter to disconnect the unit by the Master Slave network. When this parameter is set to Yes the unit follows all local settings.

4.2.5.1 Standby Chiller

Through this menu page is possible to define all settings for the Standby chiller. Refer to the section 5.10.4.2 for more details.

Setpoint/Sub-Menu	Default	Range	Description
Standby Chiller=	No	No, Auto, Master, Slave 1, Slave 2, Slave 3	Define the standby chiller
Rotation Type=	Time	Time, Sequence	Define the rotation type of the standby chiller if the previous parameter Standby Chiller is set as Auto
Interval Time=	7 Days	1...365	Define the interval time (expressed in day) for the rotation of the standby chiller
Switch Time=	00:00:00	00:00:00...23:59:59	Define the time within the day when will be performed the switch of the standby chiller
Tmp Cmp=	No	No, Yes	Enabling of the Temperature Compensation function through the standby chiller.
Tmp Comp Time=	120 min	0...600	Time constant for the enabling of the standby chiller used for the Temperature Compensation
Standby Reset=	Off	Off, Reset	Parameter to reset the counter of the standby chiller rotation

4.2.5.2 Options

Through this menu, available only in the unit configured as Master, is possible to define some parameters for the global behavior of the Master Slave Network. Refer to the section 5.10.4 for more details

Setpoint/Sub-Menu	Default	Range	Description
Master Priority=	1	1...4	Start Up / Shut Down priority of the chiller Master Priority = 1 → highest priority Priority = 4 → lowest priority
Slave 1 Priority=	1	1...4	Start Up / Shut Down priority of the chiller Slave 1 Priority = 1 → highest priority Priority = 4 → lowest priority
Slave 2 Priority=	1	1...4	Start Up / Shut Down priority of the chiller Slave 2. Priority = 1 → highest priority Priority = 4 → lowest priority This menu is visible only if the parameter M/S Num Of Unit has been configured at least with value 3
Slave 3 Priority=	1	1...4	Start Up / Shut Down priority of the chiller Slave 3. Priority = 1 → highest priority Priority = 4 → lowest priority This menu is visible only if the parameter M/S Num Of Unit has been configured at least with value 4
Master Enable=	Enable	Enable, Disable	Parameter is used to disable the Master Chiller

4.2.5.3 Thermostat control

The parameters changeable with this menu, available only in the unit configured as Master, are related to the thermoregulation of all Master Slave system.

Setpoint/Sub-Menu	Default	Range	Description
Start Up DT=	2.7°C	0.0...5.0°C	Offset respect the active setpoint for the unit startup.
Start Up DT=	1.5°C	0.0...5.0°C	Offset respect the active setpoint for the unit shutdown.
Threshold=	60%	30%...100%	Threshold of load that have to reach all units running before allow the startup of a new chiller
Stage Up Time=	5min	0min...20min	Minimum time between the start of two chillers
Stage Dn Time=	5min	0min...20min	Minim time between the stop of two chillers

4.2.5.4 Data

In this menu, available only in the unit configured as Master, are collected all main data related to the Master Slave function.

Setpoint/Sub-Menu	Default	Range	Description
Next On=	-	-,Master, Slave 1, Slave 2, Slave 4	Display next chiller that will be starts
Next Off=	-	-,Master, Slave 1, Slave 2, Slave 4	Display next chiller that will be stopped
Standby Chiller=	-	-,Master, Slave 1, Slave 2, Slave 4	Display the actual standby chiller
Switch Date/Time	-	dd/mm/yyyy hh:mm:ss	Display the day and the time in the day when will be performed the rotation of the sandby chiller
Master State=	-	Off, On	Display the actual state of the Master
Slave 1=	-	Off, On	Display the actual state of the Slave 1
Slave 2=	-	Off, On	Display the actual state of the Slave 2
Slave 3=	-	Off, On	Display the actual state of the Slave 3
Master Load=	-	0%...100%	Display the actual load of the Master
Slave 1 Load=	-	0%...100%	Display the actual load of the Slave 1
Slave 2 Load=	-	0%...100%	Display the actual load of the Slave 2
Slave 3 Load=	-	0%...100%	Display the actual load of the Slave 3
Master ELWT=	-	-	Display the Master ELWT
Slave 1 ELWT=	-	-	Display the Slave1 ELWT
Slave 2 ELWT=	-	-	Display the Slave2 ELWT
Slave 3 ELWT=	-	-	Display the Slave3 ELWT

4.2.5.5 Timers

In this menu are reported the countdowns for startup and shutdown of a new chiller

Setpoint/Sub-Menu	Default	Range	Description
Stage Up Timer=	-	-	Current delay for new chiller stage up
Stage Dn Timer=	-	-	Current delay for new chiller stage down

4.2.6 Date/Time

This page will allow to adjust the time and date in the UC. This time and date will be used in the alarm log. Additionally it's also possible to set the starting and ending date for the DayLight Saving time (DLS) if used.

Setpoint/Sub-Menu	Default	Range	Description
Actual Time=	12:00:00		
Actual Date=	01/01/2014		
UTC Diff=	-60min		Difference with UTC
DLS Enable=	Yes		No, Yes
DLS Strt Month=	Mar		DayLight Saving time start month
DLS Strt Week=	2ndWeek		DayLight Saving time start week
DLS End Month=	Nov	NA, Jan...Dec	DayLight Saving time end month
DLS End Week=	1stWeek	1 st ...5 th week	DayLight Saving time end week



On board real time clock settings are maintained thanks to a battery mounted on the controller. Make sure that the battery is replaced regularly each 2 years (see section 3.6).

4.2.7 Power Conservation

This page resumes all the settings that allows chiller capacity limitations. For more details about these parameters and the functions LWT Reset and Demand Limit refer to section 5.1.7.

Setpoint/Sub-Menu	Default	Range	Description
Unit Capacity	-	-	Displays current unit capacity
Demand Limit=	-	-	Displays current demand limit
Lwt reset Type=	None	None 4-20mA Return OAT (A/C only)	Set leaving water temperature setpoint reset type Refer to section
Max Reset Dt=	5°C	0.0...10.0°C	Refer to section
Start Reset Dt=	5°C	0.0...10.0°C	Refer to section
Cooling			
Max Reset OAT=	23.8°C	10.0...29.4°C	Refer to section (A/C only)
Start Reset OAT=	15.5°C	10.0...29.4°C	Refer to section (A/C only)
Heating			
Max Reset OAT=	0.0°C	10.0...-10.0°C	Refer to section (A/C-H/P only)
Start Reset OAT=	6.0°C	10.0...-10.0°C	Refer to section (A/C-H/P only)

4.2.8 Controller IP setup

The UC has an embedded web server showing a replica of the onboard HMI screens. To access this additional web HMI can be required to adjust the IP settings to match the settings of the local network. This can be done in this page. Please contact your IT department for further information on how to set the following setpoints.

To activate the new settings a reboot of the controller is required, this can be done with the "Apply Changes" setpoint.

The controller also supports DHCP, in this case the name of the controller must be used.

Setpoint/Sub-Menu	Default	Range	Description
Apply Changes=	No	No, Yes	Reboot of the controller to apply the changes made
DHCP=	Off	Off, On	Enable or disable the DHCP (Dynamic Host Configuration Protocol)
Act IP=	-	-	Actual IP address
Act Msk=	-	-	Actual Subnet mask
Act Gwy=	-	-	Actual Gateway
Gvn IP=	-	-	Given IP address (it will become the active) if the DHCP = Off
Gvn Msk=	-	-	Given Subnet mask
Gvn Gwy=	-	-	Given Gateway
Prim DNS=	-	-	Primary DNS
Sec DNS=	-	-	Secondary DNS
Host Name=	-	-	Name of the controller
MAC=	-	-	MAC address of the controller

4.3 View/Set Circuit

In this section it is possible to select between the available circuits and access data available for the circuit selected.

Setpoint/Sub-Menu	Default	Range	Description
Circuit #1	▶		Menu for Circuit #1
Circuit #2	▶		Menu for Circuit #2 (if present)

The submenus accessed for each circuit are identical but the content of each of them reflects the status of the corresponding circuit. In the following the submenus will be explained only once. If only one circuit is available the item Circuit #2 in the above table will be hidden and not accessible.

Setpoint/Sub-Menu	Default	Range	Description
Settings	▶		Link to circuit settings
Circuit Status=		Off: Ready Off: Cycle Timer Off: All Comp Disable Off: Keypad Disable Off: Circuit Switch Off: Alarm Off: Test Mode Off: Low Prs Pause (W/C units) Run: Preopen Run: Pumpdown Run: Normal Run: Evap Press Low Run: Cond Press High Run: High Amb Limit (A/C units) Run: Defrost (A/C units)	Status of the circuit.
Circuit Cap=	0.0%	-	Circuit Capacity
Circuit Mode=	Enable	Enable Disable	Circuit keypad enabling
Evap Pressure=	-	-	Evaporating Pressure
Cond Pressure=	-	-	Condensing Pressure
Evap Sat Temp=	-	-	Evaporating saturated temperature
Cond Sat Temp=	-	-	Condensing saturated temperature
Suction Temp=	-	-	Suction Temperature
Suction SH=	-	-	Suction Superheat
Evap Approach=	-	-	Evaporator Approach
Cond Approach=	-	-	Condenser Approach
EXV Position=	-	-	Expansion valve position
VFD Speed	0%	0-100%	Fan Speed (A/C only)

4.3.1 Settings

This page resumes the status of the circuit.

Setpoint/Sub-Menu	Default	Range	Description
EWVQ - EWLQ - EWHQ EWAQ - EWYQ Air or Water cooled scroll chiller & heat pump D-EOMHW00107-15EN			Operation Manual 33

Compressors	▶		Link to the compressor page
Circ X Cond Ctrl	▶		Link to the circuit condensing control page (W/C only)
Fan Control	▶		Link to the circuit fan control page (A/C only)
EXV	▶		Link to the EXV page
Defrost	▶		Link to the defrost page (A/C only)

4.3.1.1 Compressors

This page resumes all the relevant information about compressors of the related circuit.

Note the following compressors enumeration:

1. Compressor 1 and compressor 3 belong to the Circuit #1
2. Compressor 2 and compressor 4 belong to the Circuit #2

Setpoint/Sub-Menu	Default	Range	Description
Comp Enable	▶		Link to Compressor Enable page
Compressor 1			
State	Off	Off, On	Compressor State
Start=			Date and time of the last start
Stop=			Date and time of the last stop
Run Hours=	0h		Running hours of compressor
No. Of Starts=	0		Number of compressor starts
Compressor 3			
State	Off	Off, On	Compressor State
Start=			Date and time of the last start
Stop=			Date and time of the last stop
Run Hours=	0h		Running hours of compressor
No. Of Starts=	0		Number of compressor starts

The compressors scroll enable page allows to enable or disable each compressor of the unit.

Setpoint/Sub-Menu	Default	Range	Description
Comp 1	Auto	Off, Auto	Enabling of the compressor
Comp 2	Auto	Off, Auto	Enabling of the compressor (if available)
Comp 3	Auto	Off, Auto	Enabling of the compressor
Comp 4	Auto	Off, Auto	Enabling of the compressor (if available)

If a compressor is switched to off while it is in running, it does not shutdown immediately, but the controller waits normal shutdown for thermoregulation or unit off and after the compressor disabled will not started until it is enabled again.

4.3.1.2 Circ 1 Cond Ctrl

This page resumes all parameters for the condensing circuit control. For more details about this parameters and the circuit condensing control logic refer to section 5.6.2.

Setpoint/Sub-Menu	Default	Range	Description
Cnd Sat Tmp SP=	35.0°C	30.0...50°C	Condensing saturated temperature setpoint
Cnd Sat Tmp=	-	-	Actual condensing saturated temperature
Output=	-	-	Actual condensing control output
Max Output=	100.0%	50...100%	Maximum condensing control output
Min Output	0.0%	0...50%	Minimum condensing control output

4.3.1.3 Fan Control (A/C only)

This page resumes all settings for the fan control. For more details about this parameters and the fan control logic see section 5.6.3

Setpoint/Sub-Menu	Default	Range	Description
Cond Target=	38.0°C	20...55°C	Condensation target for fan control
Evap Target=	2.0°C	-5...10°C	Evaporation target for fan control (A/C H/P only)

Cond Sat Temp=	-	-	Condenser pressure
Evap Sat Temp=	-	-	Evaporator pressure
VFD Speed=	-	0-100%	Actual fan speed
Fan Max Speed=	100%	50...100%	Maximum fan speed
Fan Min Speed=	20%	20...50%	Minimum fan speed

4.3.1.4 EXV

This page resumes all the relevant information about the status of the EXV logic. For more details about this parameters and the control logic of the EXV refer to section 5.7.

Setpoint/Sub-Menu	Default	Range	Description
EXV State=	Closed		Closed, Pressure, Superheat
Suction SH=	-		Suction Superheat
Evap Pressure	-		Evaporating pressure
Act Position=	-		Expansion valve opening
Cool SSH Target=	6.5dK	4.4...30.0dK	Cool Suction Superheat setpoint
Heat SSH Target=	6.5dK	2.5...30.0dK	Heat Suction Superheat setpoint (H/P only)
Max Op Pressure=	900.0 kPa	890.0...1172.2kPa	Maximum operating pressure

4.3.1.5 Defrost (A/C only)

This page resumes all the relevant settings for defrost management. For further information about the defrost procedure refer to section 5.8

Setpoint/Sub-Menu	Default	Range	Description
Man Defrost=	Off	Off, On	Closed, Pressure, Superheat
Defrost Cnt=	0		Counter of defrost cycles
Defrost State=	W	W, Pr1, 4W1, Df, Pr2, 4W2, WuH	Defrost execution phase
Cond Pr Lim=	2960kPa	2200...3100kPa	Condensing pressure limit to finish the defrost
Time to Defrost=	20s	0...310s	Delay before the defrost is started when the defrost request is active
Defrost Parameter=	10dK	4...15dK	Parameter do identify the need for a defrost
Defrost Timeout=	600s	240...1800s	Maximum defrost duration
Reset Cnt=	Off	Off, On	Defrost counter Reset

4.4 Tmp Setpoints

This page allows to set the water temperature setpoints in the several modes. For more details refer to the section 0.

Setpoint/Sub-Menu	Default	Range	Description
Cool LWT 1=	7.0°C	4.0...15.0°C (cool mode) -8.0...15.0°C (cool w/ glycol mode)	Primary cooling setpoint
Cool LWT 2=	7.0°C	4.0...15.0°C (cool mode) -8.0...15.0°C (cool w/ glycol mode)	Secondary cooling setpoint (see 3.6.3)
Ice LWT=	4.0°C	-10.0...4.0°C	Ice setpoint (ice banking with on/off mode)
Heat LWT 1=	45.0°C	25.0...55.0°C	Primary heating setpoint (H/P only)
Heat LWT 2=	45.0°C	25.0...55.0°C	Secondary heating setpoint (H/P only)

4.5 Temperatures

This page shows all water temperatures, evaporator and condenser delta temperature between inlet and outlet.

Setpoint/Sub-Menu	Default	Range	Description
Evap LWT=	-	-	Evaporator leaving water temperature
Evap EWT=	-	-	Evaporator entering water temperature
Cond LWT=	-	-	Condenser leaving water temperature
Cond EWT=	-	-	Condenser entering water temperature

Evap Delta T=	-	-	Evaporator delta temperature
Cond Delta T=	-	-	Condenser delta temperature
Evap LWT Slope=	-	-	Evaporator leaving water temperature rate of change
Cond LWT Slope=	-	-	Condenser leaving water temperature rate of change

4.6 Available Modes

This page allows to set the operating mode of the unit. For more details about these parameters and the available modes of the unit refer to section 5.1.2.

Setpoint/Sub-Menu	Default	Range	Description
Modes	Cool	Cool Cool w/Glycol Cool/Ice w/Glycol Ice Heat/Cool Heat/Cool w/Glycol Heat/Ice w/Glycol Pursuit Test	Available modes for unit operations.

4.7 Timers

This page indicates the remaining cycle timers for each compressor. When the cycle timers are active any new start of a compressor is inhibited.

Setpoint/Sub-Menu	Default	Range	Description
Comp 1=		0s	
Comp 2=		0s	
Comp 3=		0s	
Comp 4=		0s	
Clear Cycle Tmr	Off	Off,On	Clear Cycle Timers
Stg Up Dly Rem=			
Stg Dn Dly Rem=			
Clr Stg Delays=	Off	Off,On	Clear Stages Delays
Ice Cycle Dly Rem			
Clear Ice Dly=	Off	Off,On	Clear Ice Delay

4.8 Alarms

This link jumps to the Alarm page. Each of the items represents a link to a page with different information. The information shown depends on the abnormal operating condition that caused the activation of unit, circuit or compressor safeties. A detailed description of the alarms and how to handle will be discussed in the section Troubleshooting this chiller.

Setpoint/Sub-Menu	Default	Description
Alarm Active	▶	List of the active alarms
Alarm Log	▶	History of all the alarms and acknowledges
Event Log	▶	List of the events
Alarm Snapshot	▶	List of alarm snapshots with all the relevant data recorded at time the alarm occurred.

4.9 Commission Unit

Setpoint/Sub-Menu	Default	Range	Description
Configure Unit	▶		See section 0
Alarm Limits	▶		See Section 4.9.2
Calibrate Unit Sensors	▶		See section 4.9.3
Calibrate Circuit Sensors	▶		See section 4.9.4
Unit Manual Control	▶		See section 0
Circuit 1 Manual Control	▶		See section 0

Circuit 2 Manual Control	▶	
Scheduled Maintenance	▶	See section 4.9.7

4.9.1 Configure Unit

This page resumes all the specific settings for this unit like unit type, number of circuits, type of condensing control, etc.. Part of these settings cannot be adjusted and are supposed to be set during the manufacturing or commissioning of this unit. The modification of each parameter in this menu requires that the unit switch is set to 0.

Setpoint/Sub-Menu	Default	Range	Description
Apply Changes=	No	No, Yes	Type yes after changes
Unit Type=	EWWD	EWWD, EWLD	Select the unit type, chiller (EWWD) or condenser less (EWLD) (W/C only)
	None	None, Chiller, HeatPump	Select the unit type basing on the model name.
Noise Class=	Std	Std, Low	Selects between the two noise class. (A/C C/O only)
Number Of Cir=	1	1,2	Number of circuit of the chiller
Inversion Type	No	No, Water, Gas	Type of inversion in heat pump mode. (W/C only)
Cond Ctrl Var=	No	No, Pressure, Cond In, Cond Out	Enabling of the condensing control (W/C only)
Cond Ctrl Dev=	None	None, Valve, VFD	Select device type used for condensing control (W/C only)
M/S Address	Standalone	Standalone, Master, Slave 1, Slave 2, Slave 3	Define if the chiller works as standalone or belongs to Master Slave network,
M/S Nom Of Unit	2	2,3,4	Indicate the number of chiller belonging to Master Slave network. This parameter have to be set <u>only</u> in the chiller Master, in all Slave units it can be let at default value as ignored.
M/S Sns Type	NTC10K	NTC10K, PT1000	Define the sensor type used to measure the common leaving water temperature. This parameter have to be set <u>only</u> in the chiller Master, in all Slave units it can be let at default value as ignored.
Unit Alm Behavior=	Blinking	Blinking, NotBlinking	Behavior of the unit alarm digital output
Display Units=	Metric	Metric, English	Measurement system
HMI Language=	English	English	
Enable Options			
PVM/GFP=	Disable	Disable, Enable	Enabling of the phase voltage monitor
External Alarm=	Disable	Disable, Event, Alarm	Enabling of the Event or External Alarm input.
Demand Limit=	Disable	Disable, Enable	Enabling of the Demand Limit signal
Lwt Reset=	Disable	Disable, Enable	Enabling of the Lwt Reset signal
Comm Module 1=	None	None, IP, Lon, MSTP, Modbus, AWM	Auto-configured when UC link with related module
Comm Module 2=	None	Modbus, Bacnet IP, Bacnet MSTP, Lon, AWM	Auto-configured when UC link with related module
Comm Module 3=	None	Modbus, Bacnet IP, Bacnet MSTP, Lon, AWM	Auto-configured when UC link with related module



Modification to any of these values will require to be acknowledged to the controller by setting "Apply Changes = Yes". This will cause a controller reboot! This action can only be performed with the Q0 switch on the unit switchbox set to 0.

4.9.2 Alarm Limits

This page contains all alarm limits, including low pressure alarm prevention thresholds. In order to ensure proper operation they have to be set manually according to the specific application.

Setpoint/Sub-Menu	Default	Range	Description
Low Press Alm=	200.0k	200.0...630.0kPa	Low pressure alarm limit

EWVQ - EWLQ - EWHQ
 EWAQ - EWYQ
 Air or Water cooled scroll chiller &
 heat pump
 D-EOMHW00107-15EN

	Pa		
Low Press Hold=	670.0k Pa	150.0...793.0kPa	Low pressure hold limit
Low Press Unld =	650.0 KPa	150.0...793.0kPa	Low pressure unload limit
Hi Press Unld=	3850k Pa	3800...3980kPa	High pressure unload limit
Hi Press Stop=	4000k Pa	3900...4300kPa	High pressure alarm limit
Evap Water Frz=	2.0°C	2.0...5.6°C (without Glycol) -20.0...5.6°C (with Glycol)	Evaporator freeze protection limit
Cond water Frz=	2.0°C	2.0...5.6°C (without Glycol) -20.0...5.6°C (with Glycol)	Condenser freeze protection limit (W/C only)
Flw Proof=	5s	5...15s	Flow proof delay
Evp Rec Timeout=	3min	1...10min	Recirculating timeout before the alarm is raised
Low OAT Strt Time	165sec	150...240s	Start time during which the low pressure alarm is ignored.
Min Delta Pres=	400.0k Pa	50...700kPa	Minimum pressure difference to trigger the Low Delta Pressure alarm



Once tripped, the software will get back to normal operation. However, the alarm will not be reset until the high pressure switches are manually reset through the button included in the switch.

4.9.3 Calibrate Unit Sensors

This page allows a proper calibration of the unit sensors.

Setpoint/Sub-Menu	Default	Range	Description
Evap LWT=	7.0°C		Evaporator LWT current reading (includes the offset)
Evp LWT Offset=	0.0°C	-5.0...5.0°C	Evaporator LWT calibration
Evap EWT=	12.0°C		Evaporator EWT current reading (includes the offset)
Evp EWT Offset=	0.0°C	-5.0...5.0°C	Evaporator EWT calibration
Cond LWT =	35°C		Condenser LWT current reading (includes the offset) (W/C only)
Cond Lwt Offset=	0.0°C	-5.0...5.0°C	Condenser LWT calibration (W/C only)
Cond EWT=	30.0°C		Condenser EWT current reading (includes the offset) (W/C only)
Cond EWT Offset=	0.0°C	-5.0...5.0°C	Condenser EWT calibration (W/C only)
OA Temp=	30.0°C		Outside Air Temperature current reading (includes the offset) (A/C only)
OA Temp Offset=	0.0°C	-5.0...5.0°C	Outside Air Temperature calibration (A/C only)

4.9.4 Calibrate Circuit Sensors

This page allows a proper calibration of the circuit sensors

Setpoint/Sub-Menu	Default	Range	Description
Evap Pressure=			Evaporator Pressure current reading (includes the offset)
Evp Pr Offset=	0.0kPa	-100.0...100.0kPa	Evaporator Pressure offset
Cond Pressure=			Condenser Pressure current reading (includes the offset)
Cnd Pr Offset=	0.0kPa	-100.0...100.0kPa	Condenser Pressure offset
Suction Temp=			Suction Temperature current reading (includes the offset)
Suction Offset=	0.0°C	-5.0...5.0°C	Suction Temperature offset
Discharge Temp=			Discharge Temperature current reading (includes the offset) (A/C only)
Discharge Offset=	0.0°C	-5.0...5.0°C	Discharge Temperature offset (A/C only)



Calibrations of the Evaporator Pressure and Suction Temperature are mandatory for the applications with negative water temperature setpoints. These calibrations have to be performed with proper gauge and thermometer. An improper calibration of the two instruments may generate limitation of the operations, alarms and even damages to components.

4.9.5 Unit Manual Control

This page contains all the test point, status of the digital inputs, status of the digital output and raw value of the analog inputs associated to the Unit. To activate the test point it's required to set the Available Modes to Test (see section 4.6).

Setpoint/Sub-Menu	Default	Range	Description
Test Unit Alarm=	Off	Off/On	Test of the General Alarm relay output
Test Evap Pump 1=	Off	Off/On	Test of the Evaporator Pump #1
Test Evap Pump 2=	Off	Off/On	Test of the Evaporator Pump #2
Test Cond Pump 1=	Off	Off/On	Test of the Condenser Pump #1
Test Cond Pump 2=	Off	Off/On	Test of the Condenser Pump #2
Test Cond Valve Out=	0.0%	0...100%	Test Valve output for condensing control
Test VFD Out=	0.0%	0...100%	Test VFD output for condensing control
Input/Output Values			
Unit Sw Inpt=	Off	Off/On	Status of the Unit Switch
Dbl Sp Inpt=	Off	Off/On	Status of the Double Setpoint
Evap Flow Inpt=	Off	Off/On	Status of the Evaporator Flow switch
Cond Flow Inpt=	Off	Off/On	Status of the Condenser Flow switch
HP Switch Inpt=	Off	Off/On	Status of the Heat Pump switch
PVM/GFP Inpt=	Off	Off/On	Status of Phase Voltage monitor, Under-Over voltage protection or Ground Fault protection (check option installed)
Ext Alm Inpt=	Off	Off/On	Status of the External Alarm
Unit Alm Outpt=	Off	Off/On	Status of the General Alarm relay
Evp Pmp1 Outpt=	Off	Off/On	Status of the Evaporator Pump #1 relay
Evp Pmp2 Outpt=	Off	Off/On	Status of the Evaporator Pump #2 relay
Cnd Pmp1 Outpt=	Off	Off/On	Status of the Condenser Pump #1 relay
Cnd Pmp2 Outpt=	Off	Off/On	Status of the Condenser Pump #2 relay
Evap EWT Res=	00Ohm	340-300kOhm	Resistance of the Evap EWT sensor
Evap LWT Res=	00Ohm	340-300kOhm	Resistance of the Evap LWT sensor
Cond EWT Res=	00Ohm	340-300kOhm	Resistance of the Cond LWT sensor
Cond LWT Res=	00Ohm	340-300kOhm	Resistance of the Cond LWT sensor
Dem Lim Curr=	0mA	3-21mA	Current input for the Demand Limit
LWT Reset Curr=	0mA	3-21mA	Current input for the Setpoint Reset
Cond Valve Outpt=	0.0V	0.0-10.0V	Voltage output for the valve of the condensing control
VFD Outpt=	0.0V	0.0-10.0V	Voltage output for the VFD of the condensing control

4.9.6 Circuit 1 Manual Control

This page contains all the test point, status of the digital inputs, status of the digital output and raw value of the analog inputs associated to the Circuit #1 (or Circuit #2 if present and depending on the link followed). To activate the test point it's required to set the Available Modes to Test (see section 4.6).

Setpoint/Sub-Menu	Default	Range	Description
Test Comp 1=	Off	Off,On	Test of the compressor 1 (first compressor of the circuit number 1)
Test Comp 3=	Off	Off,On	Test of the compressor 3 (second compressor of the circuit number 1)
Test 4 Way Valve=	Off	Off,On	Test of the 4 way valve
Test VFD=	Off	Off,On	Test of the VFD enable.
Test EXV Pos=	0.0%	0-100%	Test of the Expansion Valve movements
Test Cond Valve Out=	0.0%	0-100%	Test Valve output for condensing control
Test VFD Out=	0.0%	0-100%	Test VFD output for condensing control
Input/Output Values			
Evap Pr Inpt=	0.0V	0.4-4.6V	Input voltage for the Evap Pressure
Cond Pr Inpt=	0.0V	0.4-4.6V	Input voltage for the Cond Pressure
Suct Temp Res=	00Ohm	340-300kOhm	Resistance of the Suction Temp sensor
Comp 1 Output=	Off	Off/On	Status of the compressor 1 (first compressor of the circuit number 1)
Comp 3 Output	Off	Off/On	Status of the compressor 3 (second compressor of the circuit number 1)
Cond Valve Outpt=	0.0V	0.0-10.0V	Voltage output for the valve of the condensing control

VFD Outpt=	0.0V	0.0-10.0V	Voltage output for the VFD of the condensing control
------------	------	-----------	--

4.9.7 Scheduled Maintenance

This page may contains the contact number of the Service organization taking care of this unit and the next maintenance visit schedule.

Setpoint/Sub-Menu	Default	Range	Description
Next Maint=	Jan 2015		Schedule date for next maintenance
Support Reference=	999-999-999		Reference number or email of Service Org

4.10 Save and Restore

The controller has a feature to save and then restore on an SD card the actual unit settings. This feature can be useful when a software upgrade is needed or to keep a copy of the actual settings for future usages like a controller replacement.



In case of backup, part of the settings like number of starts and running hours may not be restored. Backups may be done periodically to save a more recent status of the settings.

This page has all the setpoints to command a save and/or a restore of a previously saved parameter file.

Setpoint/Sub-Menu	Default	Range	Description
SD Card State=	NoCard	NoCard, ReadOnly, ReadWrite	Status of the SD card.
Save to SD=	No	No, Yes	Setpoint to force a parameter file creation on an SD card
Save SD Rslt=	Idle	Fail, Pass, Idle	Result of the Save command
Rstr From SD=	No	No, Yes	Setpoint to force a parameter restore from an SD card
Rstr SD Rslt=	Idle	Fail, Pass, Idle	

Before proceeding be sure that the SD card is properly fitted in its slot as shown in the picture. A status of the SD card is also displayed in the same page to check if it's allowed to save the parameters.

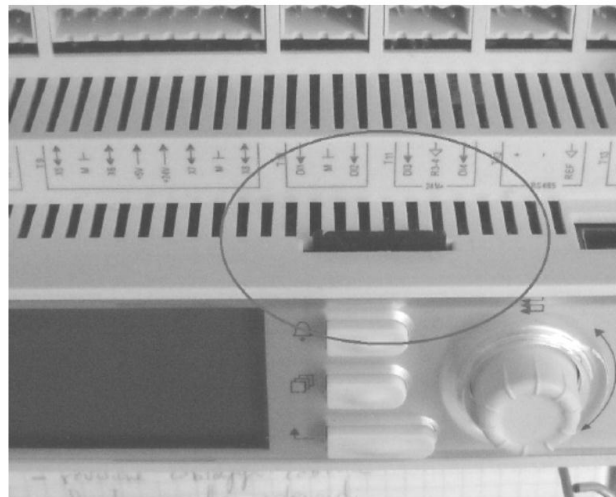
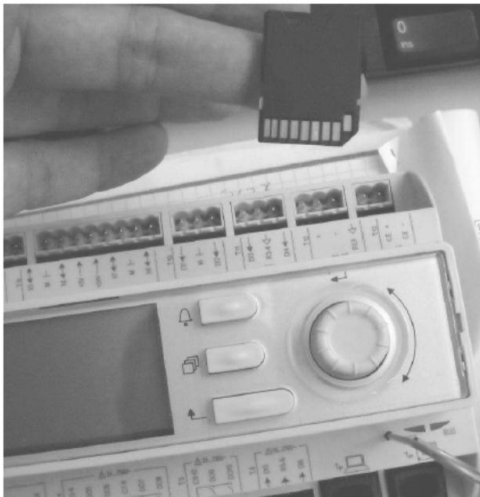

To save a copy of the settings the SD Card State must be ReadWrite (1). If the State is ReadOnly (2) check the position of the card-lock.

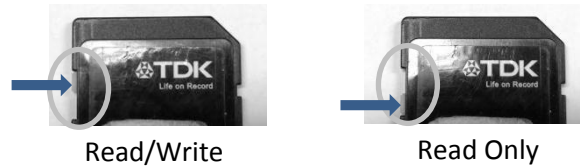

When the SD card is in and Write is allowed change Save to SD to Yes. The Save to SD Result will temporarily change to Fail and if the process is successful it will then change to Pass. A file named "PARAM.UCF" will be saved in the root folder of the SD Card.

The same procedure is used to restore the settings from a previously saved configuration file. The file must be stored in the root folder of the SD Card.

After the parameters have been restored a reboot of the controller is required to let the new settings operational.

4.11 About this Chiller

This page resumes all the information needed to identify the unit and the current software version installed. These information may be required in case of alarms or unit failure

Setpoint/Sub-Menu	Default	Range	Description
Model			Code name
G.O.			This field could contain the unit order number (OVyy-zzzzz)
Unit S/N=			Unit serial number
Enter Data			This field should contain the unit serial number (CH-yyLxxxxx)
BSP Ver=			Firmware version
App Ver=			Software version
HMI GUID=			Unique Identification of the HMI software
			HEX number for HMI GUID
OBH GUID=			Unique Identification of the OBH software
			HEX number for OBH GUID

5 Working with this unit

This chapter contains a guide on how to deal with the everyday usage of the unit. The next sections describe how to perform routine tasks on the unit and which type of controls are available on the unit.

5.1 Unit Setup

Before starting up the unit, some basic settings need to be set by the customer according to the application.

Control Source	▶	See chapter 4.2.2
Available Modes	▶	See chapter 5.1.2
Temperature Setpoints	▶	See chapter 0
Thermostat Control Settings	▶	See chapter 5.1.4
Alarm Settings	▶	See chapter 5.1.5
Pumps	▶	See chapter 0
Power Conservation	▶	See chapter 5.1.7
Date/Time/Schedules	▶	See chapter 4.2.5

5.1.1 Control Source

This function allows to select which source should be used for unit control. The following sources are available:

Local	Unit is enabled by local switches placed into the switchbox. Chiller mode (cool, cool w/glycol, ice, heat, pursuit), LWT setpoint and capacity limit are determined by local settings in the
-------	---

EWVQ - EWLQ - EWHQ
 EWAQ - EWYQ
 Air or Water cooled scroll chiller &
 heat pump
 D-EOMHW00107-15EN

	HMI.
Network	Unit is enable by a remote switch. Chiller mode, LWT setpoint and capacity limit are determined by an external BMS. This function requires: <ul style="list-style-type: none"> • Remote enable connection to a BMS (unit on/off switch must be in remote) • Communication module and its connection to a BMS.

More parameters about network control can be found in 4.2.2.

5.1.2 Available Mode Setting

The following operating modes can be selected through the Available modes menu 4.6:

Cool	Set if chilled water temperature down to 4°C is required. No glycol is generally needed in the water circuit, unless ambient temperature may reach low values.
Cool w/Glycol	Set if chilled water temperature below 4°C is required. This operation requires proper glycol/water mixture in the evaporator water circuit.
Cool/Ice w/Glycol	Set in case a dual cool/ice mode is required. This setting implies an operation with double setpoint which is activated through a customer supplied switch, according to the following logic: <ul style="list-style-type: none"> • Switch OFF: The chiller will work in cooling mode with the Cool LWT 1 as the Active Setpoint. • Switch ON: The chiller will work in ice mode with the Ice LWT as the Active Setpoint.
Ice	Set if ice storage is required. The application requires the compressors to operate at full load until the ice bank is completed, and then to stop for at least 12 hours. In this mode the compressor(s) will not operate at part load, but will work only in on/off mode.
The following three modes allow to switch the unit between heat mode and one of the previous cool mode (Cool, Cool w/Glycol, Ice) Set heat mode if warmed water temperature up to 55°C is required (H/P only)	
Heat/Cool	Set in case a dual cool/heat mode is required. This setting implies an operation with double functioning which is activated through the Cool/Heat switch on the electric box <ul style="list-style-type: none"> • Switch COOL: The chiller will work in cooling mode with the Cool LWT 1 as the Active Setpoint. • Switch HEAT: The chiller will work in heat pump mode with the Heat LWT 1 as the Active Setpoint.
Heat/Cool w/Glycol	Set in case a dual cool/heat mode is required. This setting implies an operation with double functioning which is activated through the Cool/Heat switch on the electric box <ul style="list-style-type: none"> • Switch COOL: The chiller will work in cooling mode with the Cool LWT 1 as the Active Setpoint. • Switch HEAT: The chiller will work in heat pump mode with the Heat LWT 1 as the Active Setpoint.
Heat/Ice w/Glycol	Set in case a dual cool/heat mode is required. This setting implies an operation with double functioning which is activated through the Cool/Heat switch on the electric box <ul style="list-style-type: none"> • Switch ICE: The chiller will work in cooling mode with the Ice LWT as the Active Setpoint. • Switch HEAT: The chiller will work in heat pump mode with the Heat LWT 1 as the Active Setpoint.
Pursuit (W/C only)	Set in case of double water control cool and contemporary heat. Evaporator leaving water temperature follows the Cool LWT 1 setpoint. Condenser leaving water temperature follows the Heat LWT 1 setpoint.
Test	Enables the Manual Control of the unit. The manual test feature helps in debugging and checking the operational status of sensors and acutators. This feature is accessible only with the maintenance password in the main menu. To activate the test feature is required to disable the Unit from the Q0 switch and change the available mode to Test.



When the Available Mode setpoint is changed to Test for a unit that has been configured for brine application, water setpoint, freeze limit and low pressure safeties are set to the minimum value for non-brine units and require to be restored to the previously adjusted values.

5.1.3 Temperature Setpoint Settings

Purpose of the chiller is to keep the evaporator leaving water temperature as close as possible to a pre-set value, called Active Setpoint. The Active Setpoint is calculated by the unit controller based on the following parameters and physical input

- Base setpoint determined by the actual operating mode (Cool, Cool w/Glycol, Ice, Heat, Pursuit)
- Double Setpoint (Digital input)
- Setpoint Reset (4-20mA analog input)
- OAT Reset (A/C only)
- Evaporator Delta T Reset (A/C only)

LWT setpoint can also be set via network if the appropriate control source has been selected.

Setpoint range is limited according to the selected operating mode. The controller includes two setpoint in cooling mode (either standard cool or cool w/glycol) and one setpoint in ice mode, which are activated according to Operating mode and Dual Setpoint selection. All default setpoint with their ranges are reported in the table below.

Actual Operating Mode	Double Setpoint Input	LWT Setpoint	Default	Range
Cool	OFF	Cool LWT 1	7.0°C	4.0°C ÷ 15.0°C
	ON	Cool LWT 2	7.0°C	4.0°C ÷ 15.0°C
Cool w/ Glycol	OFF	Cool LWT 1	7.0°C	-10.0°C ÷ 15.0°C
	ON	Cool LWT 2	7.0°C	-10.0°C ÷ 15.0°C
Ice	N/A	Ice LWT	-4.0°C	-10.0°C ÷ 4.0°C
Heat	OFF	Heat LWT 1	45.0°C	25.0°C ÷ 55.0°C
	ON	Heat LWT 2	45.0°C	25.0°C ÷ 55.0°C

The LWT setpoint can be overridden in case the setpoint reset (for details see chapter 5.1.7.2).



Double Setpoint, Setpoint Reset features are not operational in Ice Mode.

5.1.4 Thermostat Control Settings

Thermostat control settings allow to set up the response to temperature variations and the precision of the thermostat control. Default settings are valid for most applications, however site specific conditions may require adjustments in order to have a smooth and precise temperature control or a quicker response of the unit. The parameters mentioned below can be set from the menu 4.2.1

The following explanation can be read for Chiller/Heat Pump modes.

Compressors start conditions. The control will start the first compressor if the controlled temperature is higher/lower than the active setpoint of at least a *Start Up DT* value. The other compressors will start, one at a time, if the controlled temperature is higher/lower than the active setpoint of at least *Stage Up DT* value.

Compressors shutdown conditions. The control will shut down the compressors, one at a time, if the controlled temperature is lower/higher than the active setpoint of at least *Stage Down DT* value. Last compressor in run will shut down if the controlled water temperature is lower/higher than the active setpoint of at least *Shut down DT* value.

Temperature Limitation. The start-up and shut-down of all compressors are inhibited if the controlled water temperature decreases/increases faster than *Pull Down Rate/Pull Up Rate* limit value.

Time Limitation. The start-up and shut-down of each compressor must respect the following time constrains.

1. A compressor can start only if since the last start-up or shut-down of any other compressor the *Stage Up Delay* has expired.

2. A compressor can stop only if since the last start-up or shut-down of any other compressor the *Stage Dn Delay* has expired.
3. A compressor can start only if since its previous start-up the *Start to Start Delay* has expired
4. A compressor can start only if since its previous stop the *Stop to Start Delay* has expired

The unit capacity remains constant if the controlled temperature is within the interval:

$$[\text{Setpoint} - \text{Stage Up DT} \div \text{Setpoint} + \text{Stage Down DT}]$$

The following table summarize the conditions for compressors start and shut down explained above.

	Cool Mode	Heat Mode
First Compressor Start	Controlled Temperature > Setpoint + Start Up DT	Controlled Temperature < Setpoint - Start Up DT
Other Compressor Start	Controlled Temperature > Setpoint + Stage Up DT	Controlled Temperature < Setpoint - Stage Up DT
Last Compressor Off	Controlled Temperature < Setpoint - Shut Dn DT	Controlled Temperature > Setpoint - Shut Dn DT
Other Compressor Off	Controlled Temperature < Setpoint - Stage Dn DT	Controlled Temperature > Setpoint - Stage Dn DT

A qualitative example of compressors start-up sequence in cool mode operation is shown in the graph below.

Compressors start-up sequence - Cool

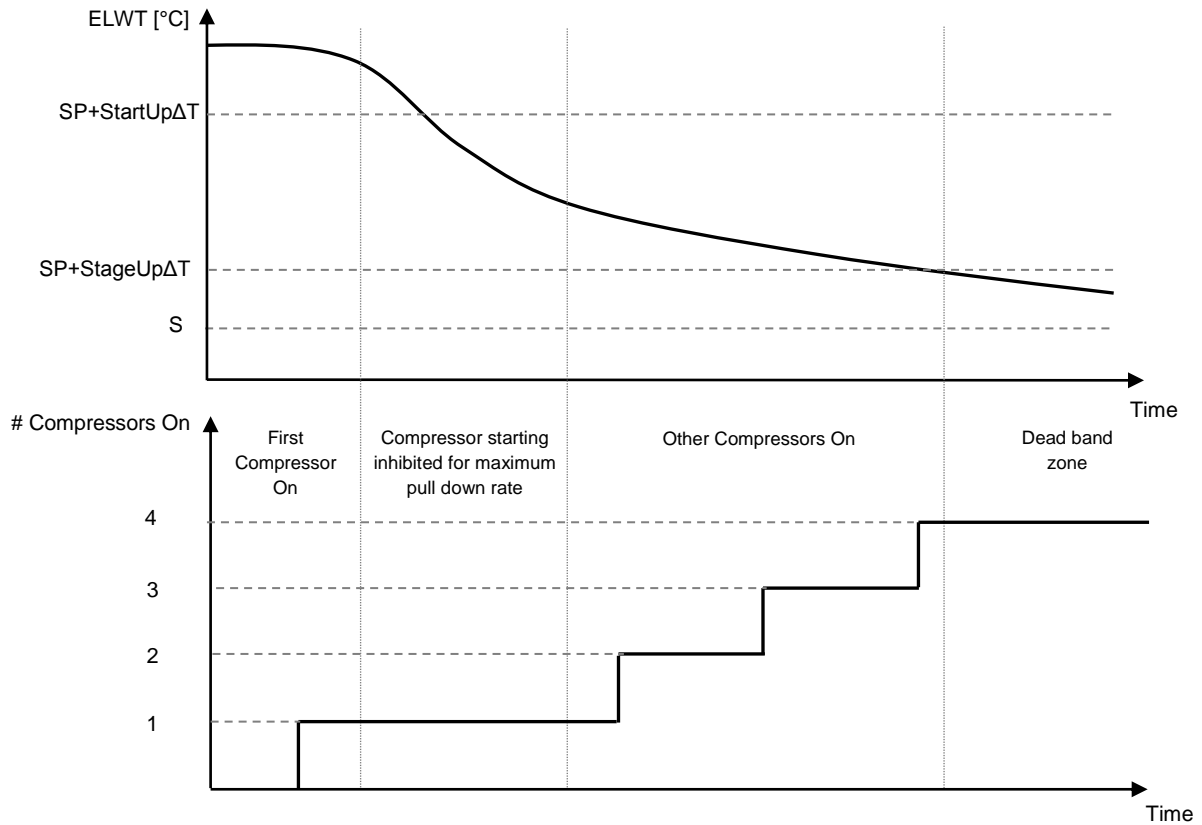

Compressors are always started and stopped to guarantee the balancing of running hours and number or starts in multiple circuits units. This strategy optimizes the lifetime of compressors, inverters, capacitors and all the others circuit components.

5.1.5 Alarm Settings

Factory defaults are set for standard cooling mode, therefore they may not be properly tuned when working at different conditions. Depending on the application, the following alarm limits need to be adjusted:

- Low Press Hold
- Low Press Unload
- Evap Water Frz
- Cond Water Frz (W/C only)

Low Press Hold	Set the minimum refrigerant pressure of the unit. It is generally recommended to set to a value whose saturated temperature is 8 to 10°C below the minimum active setpoint. This will allow a safe operation and a proper control of compressor suction superheat.
Low Press Unload	Set lower than the hold threshold enough to allow a suction pressure recovery from fast transients without unloading the compressor. A 20 kPa differential is generally appropriate for most applications.
Evap Water Frz	Stops the unit in case the evaporator leaving temperature falls below a given threshold. To allow a safe operation of the chiller, this setting must be adequate to the minimum temperature allowed by the mixture water/glycol present in the evaporator water circuit.
Cond Water Frz (W/C only)	Stops the unit in case the condenser leaving temperature falls below a given threshold. To allow a safe operation of the chiller, this setting must be adequate to the minimum temperature allowed by the mixture water/glycol present in the condenser water circuit.

5.1.6 Pumps

The UC can manages one or two water pumps either for the evaporator either for the condenser. Number of pumps and their priority can be set from the menu 4.2.4.

Evap Pump Ctrl	Set number of active pumps and priority
Cond Pump Ctrl	Set number of active pumps and priority (W/C only)
Recirc Tm	This parameter indicates the minimum time for which the evaporator/condenser flow switches must be active before to start the thermostat control

The following options are available for the pumps:

#1 Only	Set to this in case of single pump or twin pump with only #1 operational (f.e. in case of maintenance on #2)
#2 Only	Set to this in case of twin pump with only #2 operational (f.e. in case of maintenance on #1)
Auto	Set for automatic pump start management. At each chiller start, the pump with the least number of hours will be activated.
#1 Primary	Set to this in case of twin pump with #1 running and #2 as a backup
#2 Primary	Set to this in case of twin pump with #2 running and #1 as a backup

5.1.6.1 Pumps control for W/C units

The UC manages the pumps differently depending on the water circuit that they belong. The pumps connected to the load water circuit (water circuit connected with the plant) are started when the unit is set to Enabled and there are compressors available to run. The pumps connected to the source water circuit (water circuit connected with the cooling tower, water well, etc.) are started only when at least one of the compressor is started. When the unit is configured as Heat Pump with water inversion the controller inverts the functioning of the pumps. This means that the pump managed for the load water circuit in cooling mode is managed, instead, for the source water circuit in heating mode and viceversa.

If the condensing control is set as Pressure mode (see section 5.4) the pumps connected to the source water circuit are managed in a different way. Each pump is related to one of the two refrigerant circuits and it is started automatically only when required to guarantee the condensing target.

When the unit is configured as Heat Pump with water inversion the controller inverts the functioning of the pumps. This means that the pump managed for the primary water circuit in cooling mode is managed, instead, for the secondary water circuit in heating mode and viceversa.

5.1.6.1 Pumps control for A/C units

In this case the UC only manages the pumps connected to the load water circuit. Lead pump is started when the unit is set to Enabled and there are compressors available to run.

Depending on the HMI setting pumps are managed differently.

In case of twin pumps in case of flow loss, the UC will try to change over between the lead and the standby pump to avoid flow loss alarms.

When the unit is disabled the pump is kept running for additional Recirculate Timer delay.

5.1.7 Power Conservation

The unit controller provides two different functions that allow to limit the chiller capacity.

1. Demand Limit: limits the maximum unit capacity.
2. Lwt Reset: applies an offset to the base water temperature setpoint.

Both function must be enabled through the menu Configure Unit 0.

5.1.7.1 Demand Limit

Demand limit function allows the unit to be limited to a specified maximum capacity. The capacity limit is given through an external 4-20 mA signal. The table below reports the unit limitation based on the 4-20mA signal:

Number of compressors	Demand Limit Signal [mA]	Maximum unit capacity [%]	Maximum number of compressors On
2	< 12 mA	100%	2
	> 12 mA	50%	1
4	< 8 mA	100%	4
	8 mA < < 12 mA	75%	3
	12 mA < < 16 mA	50%	2
	16 mA < < 20 mA	25%	1

In the Power Conservation 4.2.7 menu are reported the actual unit capacity and actual demand limit.

Unit Capacity	Displays current unit capacity
Demand Limit	Displays active demand limit

5.1.7.2 LWT Reset

The LWT Reset function applies a variable offset to the base temperature setpoint selected through the interface from the menu Temperature Setpoints 4.3.1.5.

If the unit works in Chiller mode the offset has a positive value, so the new setpoint will be greater than the base setpoint.

If the unit works in Heat pump mode the offset has a negative value, so the new setpoint will be lower than the base setpoint.

This offset can be calculated starting from:

- External signal (4-20mA),
- Evaporator or Condenser (W/C only) ΔT (Return),
- OAT Reset (A/C only)

The following setpoints are available through the menu 4.2.7:

Lwt Rest Type	Set the Setpoint Reset mode (None, 4-20 mA, Return, OAT)
Max Reset	Max Setpoint Reset (valid for all active modes)
Start Reset DT	Used on Setpoint Reset by Evaporator DT

Setpoint Reset by External 4-20 mA Signal

The active setpoint is calculated applying a correction based on an external 4-20mA signal. 4 mA corresponds to 0°C correction, while 20 mA corresponds to a correction of the active setpoint as set in Max Reset (MR). The pictures below shows how is modified the setpoint respectively in chiller and heat pump mode. The following abbreviations are used.

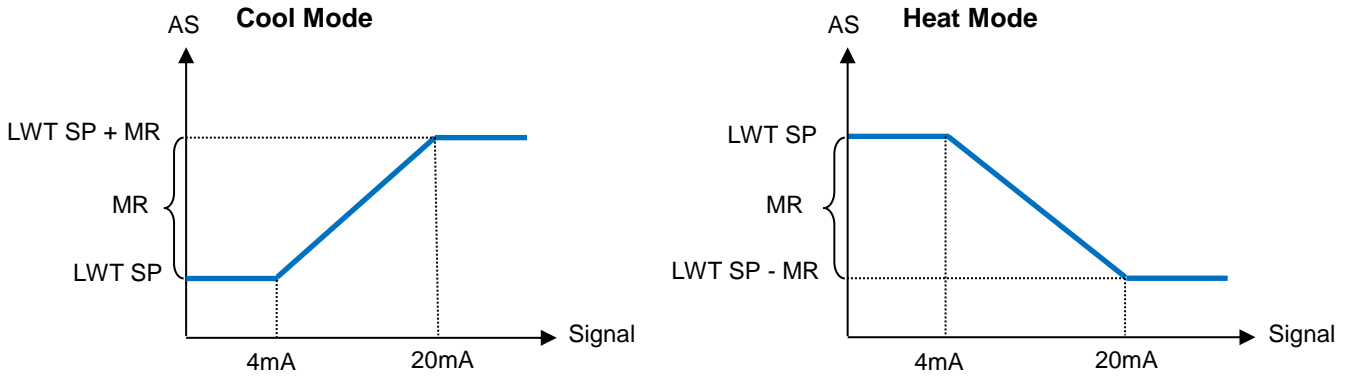

MR	Max Reset
AS	Active Setpoint
LWT SP	LWT Setpoint
Signal	4-20 mA Analog input signal

Setpoint Reset by Evaporator Return Temperature

The active setpoint is calculated applying a correction that depends on the evaporator entering (return) water temperature

If the unit works in heat pump mode with water inversion the correction depends on the condenser entering (return) water temperature (W/C only).

When the evaporator/condenser ΔT becomes lower than the $SR\Delta T$ value, an offset to the LWT setpoint is increasingly applied, up to the MR value when the ΔT is equal to zero

MR	Max Reset
AS	Active Setpoint
$SR\Delta T$	Start Reset DT
LWT SP	LWT Target

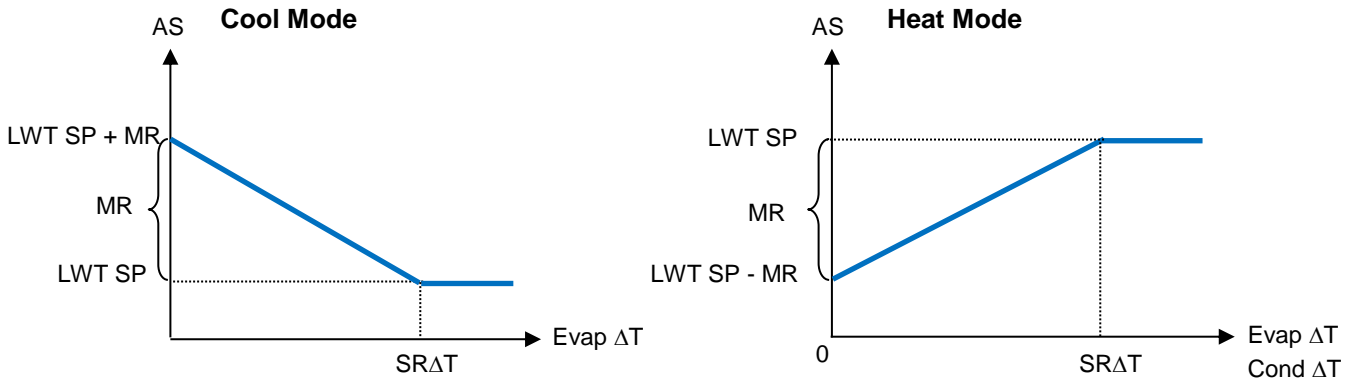

The Return Reset may affect negatively the chiller operation when operated with variable f_{l0} . Avoid to use this strategy in case of inverter water flow control.

Setpoint Reset by Outside Air Temperature (OAT) (A/C only)

The active setpoint is calculated applying a correction that depends on the outside air temperature.

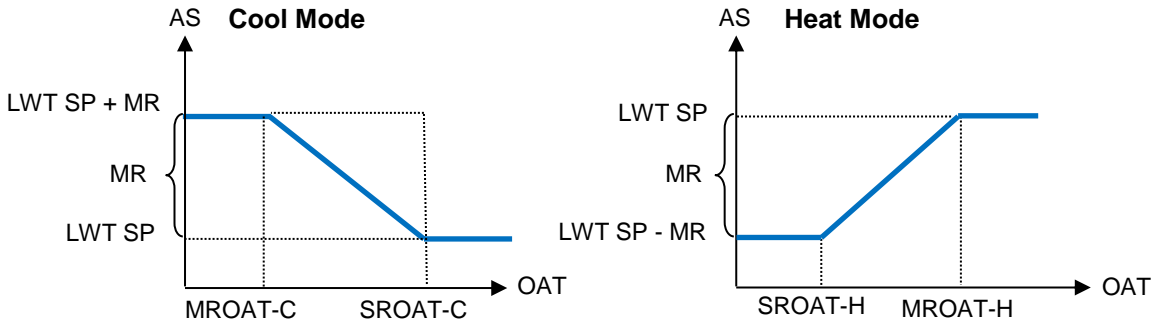

MR	Max Reset
AS	Active Setpoint
LWT SP	LWT Target
MROAT-C	Max Reset OAT Cooling
SROAT-C	Start Reset OAT Cooling
MROAT-H	Max Reset OAT Heating
SROAT-H	Start Reset OAT Heating

5.2 Unit/Circuit Start-up

In this section, starting and stopping sequence of the unit will be described. All HMI status will be briefly described to allow a better understanding of what is going on into the chiller control.

5.2.1 Prepare the unit to start

In order to let the unit start all the enable signals has to be changed to enable. The list of enabling signals are:

- Local/Remote Enable signals = Enable
- Keypad Chiller Enable = Enable
- BMS Chiller Enable Setpoint = Enable

These items will be now discussed. Each unit is equipped with a Local/Remote selector. It is installed on the unit switchbox and can be positioned on three different positions: Local, Disable, Remote as shown in the following picture:



With the Q1 switch in the Stop position the unit is disabled. Pump will not start in normal operational condition. Compressors are kept disabled independently from the status of the individual enable switches.



With the Q1 switch in the Start position the unit is enabled. Pump will start if all other enable signals are set to enable and at least one compressors is available to run



With the Q1 switch in the Remote position the unit can be enabled using the additional connections available on the connection terminals. A closed loop will identify an enable signal, this can come from a remote switch or a timer by example.

The Keypad enable signal cannot be modified with the user password level but it requires the maintenance password.

The last enable signal is coming through the high level interface, that mean from a Building Management System. From a BMS connected to the UC using a communication protocol the unit can be disabled. To see if the enable signal is coming from a BMS in the View/Set Unit and then Status/Settings check the Control Source, if it is set to Network than the Network En SP setpoint in the same page will reflect the actual signal coming from the BMS. If the value is set to Disable then the unit cannot start. In this case check with your BAS company how the chiller is operated.

The Unit Status will inform about the current unit status, possible status will be described in the following table:

Overall Status	Status	Description
Off:	Ice Mode Tmr	This status can be shown only if the unit can work in Ice Mode. The unit is off because the Ice setpoint has been satisfied. Unit will remain off until the Ice Timer has expired.
	All Cir Disabled	No circuit is available to run. All circuits can be disabled by a component safety condition active or can be disabled by keypad or can be all in alarms. Check the individual circuit status for further details.
	Unit Alarm	A unit alarm is active. Check the alarm list to see what is the active alarm inhibiting the unit to start and check if the alarm can be cleared. Refer to the Troubleshooting section before proceeding.
	Keypad Disable	The Unit has been disabled by keypad. Check with your local maintenance if it can be enabled.
	Unit Loc/Rem Switch	The Local/Remote enable switch is set to disable. Turn it to Local to enable the unit to start its starting sequence.
	BAS Disable	Unit is disabled by BAS/BMS system. Check with the BAS company how to start the unit.
	Test Mode	Unit mode set to Test. This mode is activated to check operability of onboard actuators and sensors. Check with the local maintenance if the Mode can be reverted to the one compatible with unit application (View/Set Unit – Set-Up – Available Modes).
	Cfg Chg, Rst Ctrlr	The configuration of the unit is changed and the controller requires a reboot
Auto		Unit is in Auto control. The pump is running and at least one compressor is running.
Auto:	Wait For Load	Unit is in standby because the thermostat control satisfied the active setpoint.

Evap Recirc	Unit is running the evaporator pump to equalize the water temperature in the evaporator.
Wait For Flow	Unit pump is running but the flow signal still indicate a lack of flow through the evaporator.
Pumpdn	Unit is shutting down.
Max Pulldn	Unit thermostat control is limiting the unit capacity because the water temperature is dropping at a rate that could exceed the active setpoint.
Unit Cap Limit	Demand limit has been hit. Unit capacity will not further increase.
High Amb Limit (A/C only)	Ambient temperature is higher than 46.6°C the unit capacity will be limited to 50% in case of single circuit units.
Defrost	One circuit is performing a defrost procedure

As soon as the unit status turns to Auto, the start sequence is initiated. The start sequence follows the steps indicated in the simplified flowchart:

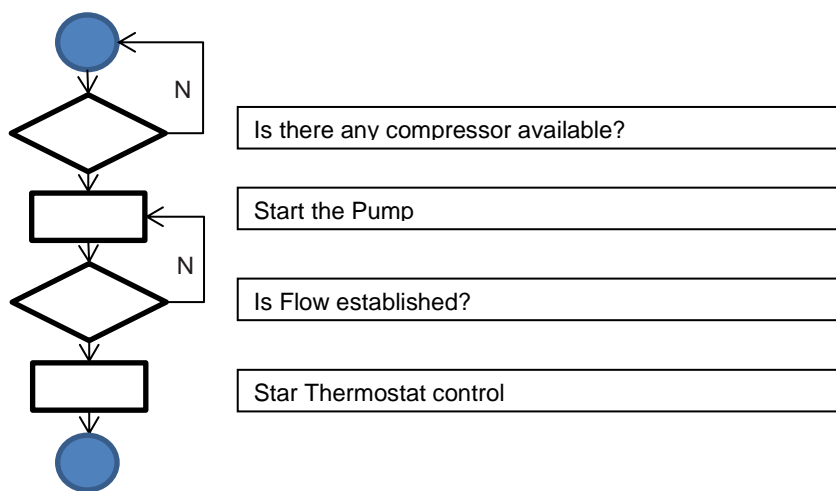

5.2.2 Preparing circuits to start

To allow a circuit start up is required to enable the circuit through the parameter Circuit Mode in the menu 0

The status of the circuit is indicated in the View/Set Circuit – Circuit #x. The possible status will be described in the following table.

Overall Status	Status	Description
Off:	Ready	Circuit is off waiting for a stage up signal from thermostat control
	Cycle Timer	Circuit is off waiting for the compressor cycle timer to expire
	All Comp Disable	Circuit is off, as all compressors are disable
	Keypad Disable	Circuit is off by the local or remote HMI. Check with your local maintenance if it can be enabled.
	Alarm	A circuit alarm is active. Check the alarm list to see what is the active alarm inhibiting the circuit to start and check if the alarm can be cleared. Refer to the Troubleshooting section before proceeding.
	Test Mode	Circuit mode set to Test. This mode is activated to check operability of onboard circuit actuators and sensors. Check with the local maintenance if the Mode can be reverted to Enable.
Run:	Preopen	EXV prepositioning before compressor starts.
	Pumpdown	Circuit is shutting down because of thermostat control or pumpdown alarm or because the enable switch has been turned to off.
	Normal	Circuit is running within the expected operational conditions.
	Evap Press Low	Circuit is running with low evaporator pressure. This could be due to a transitory condition or a lack of refrigerant. Check with the local maintenance if corrective actions are required. Circuit is protected by preventive logic.
	Cond Press High	Circuit is running with high condenser pressure. This could be due to a transitory

		condition or high ambient temperature or problems with the condenser fans. Check with the local maintenance if corrective actions are required. Circuit will be protected by preventive logic.
	High Amb Limit	Ambient temperature is higher than 46.6°C the unit capacity will be limited to 50% in case of single circuit units.
	Defrost	This circuit is performing a defrost procedure

If the circuit is allowed to start, the starting sequence is initiated. Starting sequence is described in a simplified version with the following flowchart.

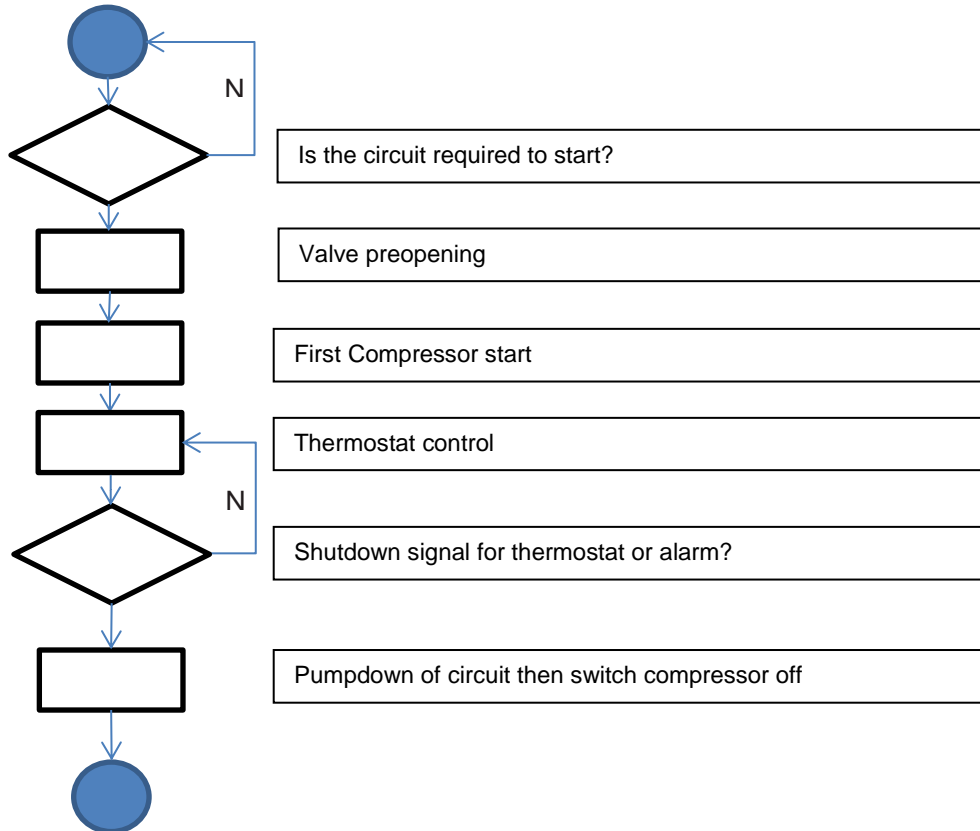

5.3 Circuit Capacity Control

Once a Circuit is started, capacity will be adjusted according to thermostat control requirements. However, there are some limitations which override the capacity control in order to prevent the chiller from abnormal running conditions. These preventions are summarized below:

- Low Evaporating Pressure
- High Condensing Pressure

5.3.1 Low Evaporating Pressure

When the circuit is running and the evaporating pressure drops below the safety limits (see section 4.9.2) the circuit control logic reacts at two different levels in order to recover the normal running conditions.

If the evaporating pressure drops below the Low Pressure Hold limit, a new starting of the compressor is inhibited. This condition is indicated on the controller display in the circuit status as “Run: Evap Press Low”. The status is automatically cleared when the evaporating pressure rise above the Low Pressure Hold limit by 20 kPa.

If the evaporating pressure drops below the Low Pressure Unld limit and at least two compressor in the same circuit are on, one compressor is shut down in order to recover the normal operating conditions. This condition is indicated on the controller display in the circuit status as “Run: Evap Press Low”. The status is automatically cleared when the evaporating pressure rise above the Low Pressure Hold limit.

If the evaporating pressure drops below the Low Press Alm limit the related circuit is immediately stopped and a Low Pressure Alarm is generated.

See section 6.1.7.2 to troubleshoot this problem.

5.3.2 High Condensing Pressure

When the circuit is running and the condensing pressure rises above the safety limits the circuit control logic reacts at two different levels in order to recover the normal running conditions.

If the condensing pressure rises above the High Pressure Unload limit and at least two compressor in the same circuit are on, one compressor is shut down in order to recover the normal operating conditions. This condition is indicated on the controller display in the circuit status as “Run: Cond Press High”. The status is automatically cleared when the condensing pressure falls below the High Pressure Hold limit by 862 kPa.

If the condensing pressure rises above the Hi Press Stop limit the related circuit is immediately stopped and an High Pressure Alarm is generated.

See section 6.1.7.3 to troubleshoot this problem.

5.4 Mode Change-Over (H/P only)

Mode change-over switch is only present on units with the heat pump option. It allows to switch from heat mode to cool mode and vice-versa. Change over should be performed seasonally, following the prescriptions required for this specific activity.



With the Q8 switch in the Cooling position the unit will operate in Cool mode. Cool setpoints will be used. In case of 4 way valve, the corresponding solenoid valve will be de-energized.



With the Q8 switch in the Heating position the unit will operate in Heat mode. Heat setpoints will be used. In case of 4 way valve, the corresponding solenoid valve will be energized.



With the Q8 switch in the Remote position the unit will be commanded by a remote switch. If the switch will remain open the unit will operate in Cool mode. If the switch will close the unit will operate in Heat mode.

When a mode change over will be commanded, the unit will be switched off in order to execute the exchange of the 4 way valve if installed.

5.5 Backup Heaters (A/C only)

In predefined circumstances and if enabled, the UC may decide to enable the additional backup heater contact.

The heater contact has to be connected to an external backup heater inserted into the buffer tank of the customer's water system.

There are several conditions that can enable the heater contact:

- When the unit runs at low ambient temperature it may not be able to satisfy the Heat Setpoint. In this case if all of the following are TRUE:
 - the OAT is lower than the Backup Heater enable temperature,
 - the unit is running at full capacity,
 - the Leaving Water Temperature is lower than the Heat Setpoint – Stage Up dT,
- If unit is in defrost,
- If there is an alarm active AND the Leaving Water Temperature is lower than the Heat Setpoint – Stage Up dT,



To activate the Backup Heater no Capacity Limitation must be active.

The Backup Heater is then deactivated if any of the following is TRUE:

- the Leaving Water Temperature rises above the Heat Setpoint,
- the Unit Mode is different from Heat,
- A Capacity Limitation become active.

5.6 Condensation Control (W/C only)

The UC provides the possibility to choose between three different types of condensing control:

1. Pressure
2. Cond In
3. Cond Out

Depending on the unit type (Chiller, Condenser less, Heat pump with water inversion, Heat pump with gas inversion) only some of the previous condensing controls are available.

5.6.1 Pressure (W/C only)

Pressure control is available for the following unit type:

- Chiller
- Condenser-less

In this control mode the controller regulates the condensing saturated temperature (quantity directly connected to the condensing pressure). From the menu Circ x Cond Control 4.3.1.2 is possible set condensing saturated temperature setpoint and the maximum and minimum output of the regulation signal.

When this condensing control mode is active the controller provides two 0-10V signals (one per circuit) that can be used to control one/two remote condensers (in case of condenser-less unit) or one/two water valves (in case of chiller).

The controller also provides two digital contact (one per circuit) that can be used to enable the remote condensers or the condensing pumps.

5.6.2 Cond In / Cond Out (W/C only)

These two control modes are available for the following unit type:

- Chiller
- Heat pump with gas inversion

In this modes the controller regulates the condenser entering (Cond In) or leaving (Cond Out) water temperature. Through the menu Unit Cond Ctrl 0 it is possible to set the water setpoints in cool and heat modes. When one of these condensing controls is chosen the logic checks if the setpoint is compatible with the operating area (envelope) of the compressors that depending on the actual evaporating leaving water temperature. If necessary the condensing setpoint set by HMI is overwritten and displayed in the item *Cnd Act SP*.

When this control is active the controller provides a unique 0-10V signal for the control of one three way valve or one cooling tower. This means that for the Double circuit unit (Dual) the common entering/leaving condenser water temperature will be controlled.

5.6.3 Fan Control (A/C only)

Fan control is used to keep the condenser pressure at a level that guarantee the best operation at any ambient condition both in cool and heat mode.

In cooling mode the fan speed is controlled with a PID regulator in order to maintain the condenser pressure at a stable value. Depending on the ambient temperature fans may not be able to maintain the condenser pressure at the setpoint even while running at the full speed. Maximum fan speed can be lower than 100%, this may depend on the noise class of this unit. In case an high pressure event will activate the maximum fan speed can be forced to full speed also for low noise units in order to prevent high pressure trips.

In heating mode the fan speed is controlled with a PID regulator in order to maintain the evaporator pressure at a stable value. When the ambient temperature is below 15.0°C the fans are forced to run at full speed independently from the evaporator pressure to keep the circuit operation stable and avoid as much as possible defrosts. In heat mode the fans can reach the full speed if needed, no limitation is applied in this case also for low noise units.

5.7 EXV Control

As a standard, the unit is equipped with one electronic expansion valve (EXV) per circuit, moved by a stepper motor. The EXV controls the suction superheat in order to optimize evaporator efficiency and avoid at the same time suction of liquid to the compressor.

The controller integrates a PID algorithm which manages the dynamic response of the valve in order to keep a satisfactory quick and stable response to system parameter variations. PID parameters are embedded into the controller and cannot be changed. The EXV has the following operating modes:

- Pre-open
- Start
- Pressure

- Superheat

The parameters mentioned below in italics can be set from the menu 4.3.1.3.

When the circuit is required to start, the EXV will go into the Pre-open with a fixed opening *Pre Open %* for a fixed time *Pre Open Time*.

After that, the EXV can change to Start phase, in which it works always with a fixed opening *Start %* and for a fixed time *Start Time*. The compressor will start synchronously with this transition.

Ended the Start phase the EXV switches in Pressure control to maintain the evaporating pressure close to pressure target *Max Op Pressure*.

When the EXV works in pressure mode the transitions to Superheat mode is possible if the following conditions are met:

- $SSH < SSH \text{ Target} + 1.5^{\circ}\text{C}$
or
- Pressure control active for plus than 5 minutes

When the EXV works in Superheat mode the control maintains the superheat close to the *Cool SSH target* or *Heat SSH target* depending on the actual operating mode.

The transition from Superheat Control to Pressure Control may happen only if the evaporating pressure increases above the Maximum Operating Pressure (MOP) limit:

- $\text{Evap Press} > \text{Max Op Press}$

Whenever the circuit is running, the EXV position is limited between 2% or 98% position.

Any time the circuit is in the Off or starts the shutdown procedure, the EXV shall be in the closed position. In this case additional closing steps are commanded to guarantee a proper recovery of the zero position.

5.8 Defrost (A/C only)

When the outside air become colder the circuit can start a defrost procedure. An algorithm is used to determine the presence of ice on the air heat exchanger. The ice accumulation tends to degrade the performances and for this reason a defrost may be needed to remove the ice layer.

Defrost is divided in phases. In each phase a specific status is forced to allow a proper execution of the defrost. First of all the circuit is prepared for the 4 way valve change over to cool mode. To do this smoothly one compressor is switched off and the exv prepared to manage the change over. The 4 way valve is then changed to cool mode position and after a delay the other compressors are also started. The defrost will finish when the discharge pressure reaches a pressure target that has been determined to guarantee a complete deicing of all the coil surface.



Decreasing the Condensing Pressure limit may cause ice accumulation on the coils with degradation of the unit performance. In case of need contact your local Daikin Service reference.

If the Condensing Pressure limit is not reached within the Defrost Timeout limit, the defrost is finished and the circuit changed over back to heat mode.



If during the defrost the circuit cannot reach the final Condensing Pressure limit before the timer expires consider to increase this time limit. In case of doubts contact your local Daikin Service reference.

There are other protections that may stop the defrost before it reaches the Condensing Pressure limit or the timer expires. In particular if the discharge temperature rises above a safety limit value the defrost is finished and the circuit change over back to heat mode.

During the whole period of operation in cool mode the fans will never be started to let the Condensing Pressure reach the limit.

The Defrost will be performed in a sequence of 7 steps:

Nr	Phase	Description
1	W	Wait for the defrost interstage timer to expire
2	Pr1	Preparation to 4 Way Valve change-over to Cool Mode
3	4W1	4 Way Valve change-over to Cool Mode execution
4	Df	Defrost
5	Pr2	Preparation to 4 Way Valve change-over to Heat Mode
6	4W2	4 Way Valve change-over to Heat Mode execution
7	WuH	Heating Warm-Up (back to normal operation)

5.9 Four Way Valve (H/P gas side reversal only)

The four way valve is managed by each circuit to follow the active unit mode. To guarantee a proper handling of this device the four way valve can only be commanded with a minimum delta pressure. This statement implies that the four way valve command can be given only when a compressor is running.

5.10 Master/Slave

In this section will be described the Master Slave (MS) control logic and all scenarios where this function can be applied. MS control consists in a common management of more chillers interconnected between them through the serial communication Konnex, where a chiller defined Master gets the control of all other chillers defined Slaves.

5.10.1 Master Slave Overview

Master Slave function allows to control multi-chiller plant with a maximum of 4 chillers, 1 Master + 3 Slaves, connected in parallel in the water circuit. Temperature control is always performed on the base of the common leaving water temperature read by the Master chiller.

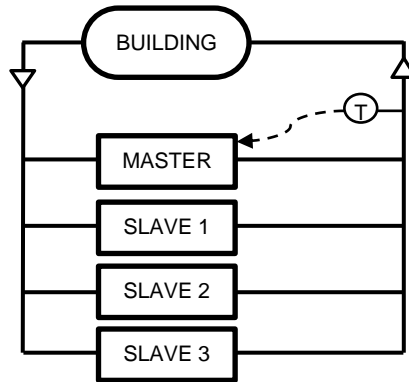

The MS function is able to manage individually several plants. The main difference that identifies every plant type is mainly in the number and in the connection method of the water pumps. The MS never can provide a speed modulation signal for one or more water pumps.

- **Plant 1 : Single Common Pump**

The simplest plant that Master Slave function can manage is composed by a single common pump installed on the water manifold that provided the water flow for all chillers of the network. The pump enable is obtained putting in parallel the enable contacts of the evaporator water pump of each chiller. First chiller enabled to start by the Master will activate the common pump. With this plant type all chillers are always crossed by the water flow even if they are still.

- **Plant 2 : Single Chiller Pump**

In the second plant type every chiller of the Master Slave network is equipped with a pump. The pump can be installed directly on the unit or in the pipe of the single chiller and it avoids the water flow in the evaporator if the chiller is in off state. Every pump will be commanded only by the chiller to which is connected.

- **Plant 3 : Double Chiller Pump**

Third plant type is an extension of the previous plant. As standard every chiller can control two evaporator water pumps: primary and standby. This function is maintained also in Master Slave. Every pair of pumps is connected to the related chiller that will manage them rotation according to the local settings.

- **Plant 4. Chiller with sectioned evaporator**

In the last plant type every chiller has the evaporator sectioned by a two way valve that avoids the water flowing if the chiller is not running. The number of pumps and valves has to be the same of number of chillers, as every pump and every valve is associated to a specific chiller. Like in the Single Chiller Pump plant every chiller will enable its valve and its pump. No standby pump can be managed in this plant type.

In this case it is advisable to connect the evaporator water pump enable provided by the chiller to the valve and consequently the feedback of total opening of the valve to the enable of the pump. In this way should be avoided all problems of over-pressure due to a simultaneous starting of the pump and of the valve.

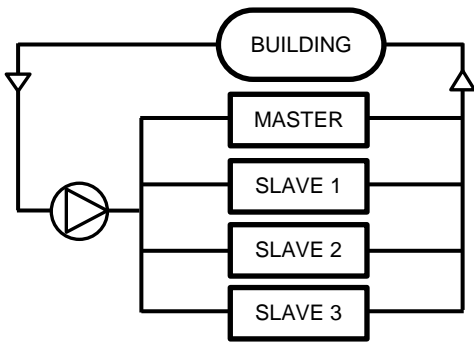

Single Common Pump

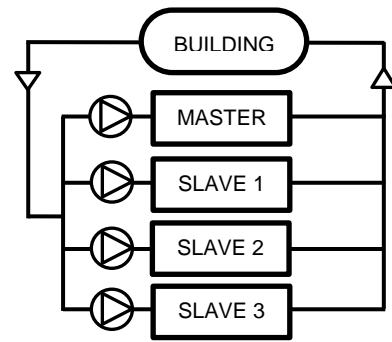

Single Chiller Pump

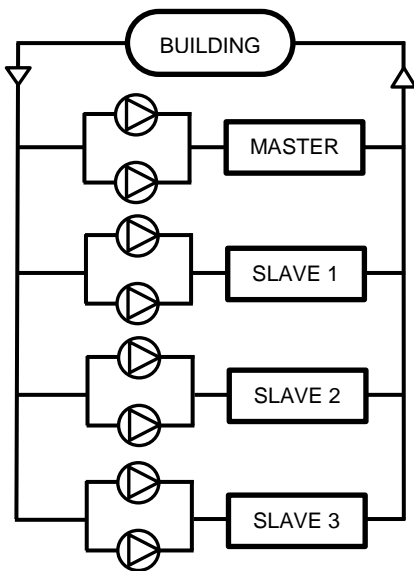

Double Chiller Pump

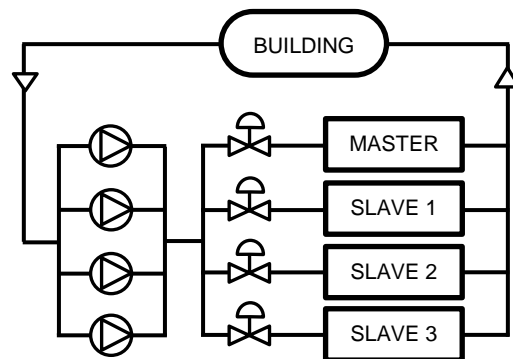

Chiller with sectioned evaporator

5.10.2 Electrical Connection

In the following section are reported all electrical connections necessary for the correct operation of the Master Slave function.



All schemes present in this section provide only a principle diagram of the electrical connection

5.10.2.1 Process Bus

The following diagram shows how have to be connected the chillers between them to establish the Master Slave Network. Starting from first chiller connect in parallel all terminals PB [CE+ / CE-] of

each controllers, accessible on the customer terminal board. Refer to the table 1.7 for the enumeration of the terminals.

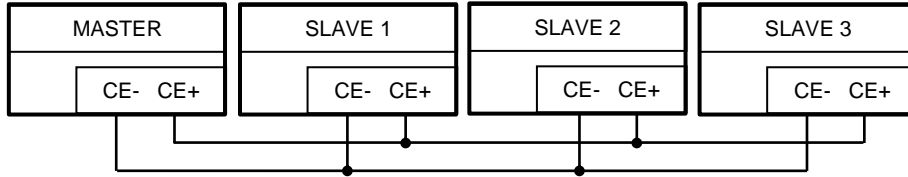

5.10.2.2 Common leaving water temperature sensor

Common leaving water temperature sensor has to be connected to the chiller Master through the customer terminal block (Master/Slave Temperature Sensor). Refer to the table 1.7 for the enumeration of the terminals.

5.10.2.3 Pumps Connection

Different types of pump connections are available depending on the plant type where the Master Slave function is used.

1. Single Common Pump

In the plant type Single Common Pump, where a unique pump provides all water flow, all enable pump contacts of each chiller have to be connected in parallel so that it is possible to provide a unique enabling contact for the common pump. The pump contact of each chiller is available on the customer terminal block (Evaporator Pump #1 start). Refer to the table 1.7 for the enumeration of the terminals.

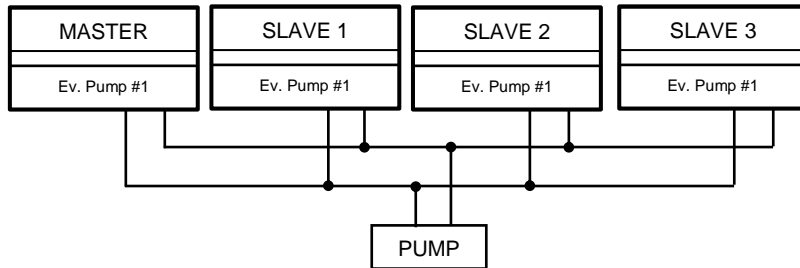

For the water cooled unit with water inversion, remember that in heat mode the user side pump is not the evaporator pump but the condenser pump. For this reason will be necessary use the terminal Condenser Pump #1 start to control the common pump

2. Single Chiller Pump

In the plant type Single Chiller Pump, every pump have to be connected to the related unit. The enabling contact is available on the customer terminal block (Evaporator Pump #1 start). Refer to the table 1.7 for the enumeration of the terminals.

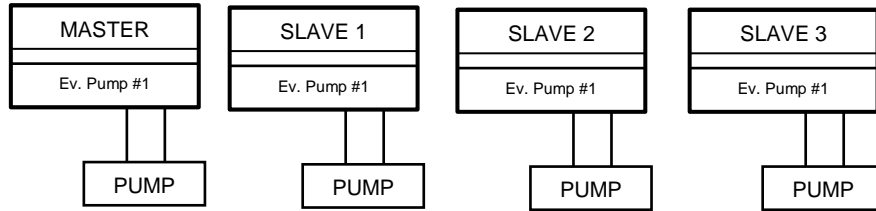

3. Double Chiller Pump

In the plant type Double Chiller Pump, every pair of pump have to be connected to the related chiller. The enabling contact are available in the customer terminal block (Evaporator Pump#1 start / Evaporator Pump#2 start). Refer to the table 1.7 for the enumeration of the terminals.

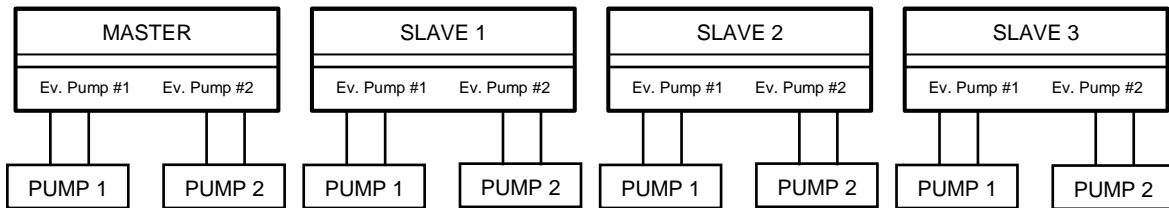

4. Chiller with sectioned evaporator

In the plant where the evaporator is sectioned by a two way valve, connect the valve to the pump enable provided by the chiller and the pump to the total opening feedback of the valve. The enabling contact is available in the customer terminal block (Evaporator Pump#1 start). Refer to the table 1.7 for the enumeration of the terminals.

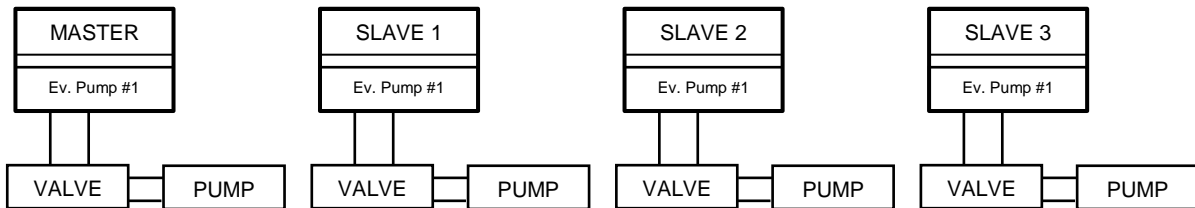

5.10.3 Master Slave Operation

5.10.3.1 Master Slave configuration

The basic configuration of the Master Slave function requires the set of three parameters available in the unit configuration menu 4.9.1:

Setpoint/Sub-Menu	Default	Range	Description
M/S Address	Standalone	Standalone Master Slave 1 Slave 2 Slave 3	Define if the chiller works as standalone or if belongs to Master Slave network. Standalone: Current unit does not belong to the Master Slave network Master: Current unit is defined Master Slave 1: Current unit is defined Slave 1 Slave 2: Current unit is defined Slave 2. This address can be assigned only if the parameter M/S Num Of Unit = 3 or 4 Slave 3: Current unit is defined Slave 3. This address can be assigned only if the parameter M/S Num Of Unit = 4 Example: If in a network there are 3 chillers then them have to be addressed like :

			Master - Slave 1 - Slave 2. Any other addressing will generate a configuration alarm
M/S Num Of Unit	2	2,3,4	Indicate the number of chiller belonging to Master Slave network. This parameter have to be set <u>only</u> in the chiller Master, in all Slave units it can be let at default value as ignored.
M/S Sns Type	NTC10K	NTC10K, PT1000	Define the sensor type used to measure the common leaving water temperature. This parameter have to be set <u>only</u> in the chiller Master, in all Slave units it can be let at default value as ignored.

5.10.3.2 System enable

The startup and shutdown of all system can be performed applying the normal enabling commands (Local/Remote switch, HMI command, enable by Modbus/BACNet/Lon) to the master unit.

All other slaves unit maintain however their local enabling. When a slave is locally not enable, the master will consider it as not ready unit and will not send it starting commands.

Since that the master loses his its local enabling (used as system enable), it is present in the menu 4.2.5.2 the parameter **Master Enable** that allows to disable the Master. Disable the Master unit means that it will not use for the thermoregulation but it will continue to acquire the common leaving water temperature and it will continue to send the activation command to the slave units.

5.10.3.3 System setpoint

Temperature control in the MS is performed on the base of the common evaporator leaving water temperature respect the target value set in the Master chiller. This setpoint is global for all system and it is sent by the Master to all Slaves through the serial communication.

Like in the single chiller, every function to modify the target value (LWT Reset, Double setpoint, changes by Modbus/BACNet/Lon) can be applied to the Master to modify the global temperature target.



On the Slave chillers the parameter **Active Setpt** (refer to section 4.1) always will display the target received by the master except when the unit is in alarm communication or the function **Disconnect Mode** 5.10.4.3 is active.

5.10.3.4 System Operating Mode: Cool/Heat/Ice

All units belonging to the Master Slave network always have to work with same operating mode. Since that in all units the operating mode is local, master chiller does not send its operating mode, it is very important verify that the changeover Cool, Heat, Ice always will be performed in all unit.



For the water cooled chiller remember that the Master Slave cannot manage the Pursuit mode.

5.10.3.5 Operation with a communication alarm

All Slave units communicate through a serial communication with the Master unit. If during the normal functioning occurs a communication failure between Master and Slave the system continue to run with the followings behavior:

- The Slave unit that has lost the communication with the Master starts to operate as a Standalone unit following all local settings
- The Master unit detects that there is a communication error with a Slave and if present enable the Standby Chiller
- If the Master unit loses the communication with all units of the network then all chiller will work in standalone mode

5.10.4 Master Slave Options

5.10.4.1 Chiller Priority

Startup and shutdown of each chiller is managed by the Master based on the conditions reported in the table below

Conditions	Next Chiller to start	Next Chiller to stop
1 st	Highest priority	Lowest priority
2 nd	Lowest number of starts	Lowest load
3 rd	Lowest running hours	Highest running hours
4 th	Lowest address	Highest number of starts
5 th	-	Lowest address

First condition is related to the priority defined for each chiller. The priority default values are all 1, i.e. all unit have the same priority. A value of 1 indicates highest priority, a value of 4 indicates lowest priority. The priority values can be modified on the Master chiller (refer to section 4.2.5.2)

5.10.4.2 Standby Chiller

Master Slave function allows to define one of the chillers belonging to the network as standby chiller. The standby chiller is normally off and becomes operating only when one of the following conditions occurs:

1. At least one chiller is in alarm state.
2. At least one of the Slave chillers is in communication alarm with the Master chiller.
3. At least one chiller is not enabled.
4. The function Temperature Compensation is enabled and the water temperature setpoint is not reached with the system at full load.

In the following is explained step by step how to set all parameters changeable through the menu 4.2.5.1 to configure the standby chiller according to the local requirements.

Step 1 : Selection of the standby chiller.

Setpoint/Sub-Menu	Default	Range	Description
EWWQ - EWLQ - EWHQ EWAQ - EWYQ Air or Water cooled scroll chiller & heat pump D-EOMHW00107-15EN			Operation Manual 63

Standby Chiller	No	No Auto Master Slave 1 Slave 2 Slave 3	<p>No = There are not standby chiller in the Master Slave network</p> <p>Auto = One of the chillers of the Master Slave network will be always assigned as standby chiller. The rotation of the standby chiller will be performed according to the configuration set through the parameters Rotation Type and Interval Time</p> <p>Master = Master chiller is always set as standby chiller</p> <p>Slave 1 = The Slave 1 chiller is always set as standby chiller</p> <p>Slave 2 = The Slave 2 chiller is always set as standby chiller</p> <p>Slave 3 = The Slave 3 chiller is always set as standby chiller</p>
-----------------	----	---	---

Step 2 : Define rotation type of the standby chiller.

Define the rotation type of the standby chiller make sense only if the parameter **Standby Chiller** is set as **Auto**

Setpoint/Sub-Menu	Range	Description
Rotation Type	Time, Sequence	<p>Time = The next Standby chiller will be the chiller with most running hours at the moment of the changeover</p> <p>Sequence = The next standby chiller will be the next according to the following sequences:</p> <ul style="list-style-type: none"> - network with one slave: Master → Slave 1 → Master - network with tow slaves: Master → Slave 1 → Slave 2 → Master - network with three slaves: Master → Slave 1 → Slave 2 → Slave 3 → Master

Step 3 : Interval time for rotation of the Standby Chiller.

Define the interval time for rotation of the Standby Chiller make sense only if the parameter **Standby Chiller** is set as **Auto**

Setpoint/Sub-Menu	Default	Range	Description
Interval Time	7 Days	1...365	Define the interval time (expressed in day) for the rotation of the standby chiller.
Switch Time	00:00:00	00:00:00...23:59:59	Define the time within the day when will be performed the switch of the standby chiller

Step 4 : Enable of Temperature Compensation function

Choose if enable the temperature compensation function

Setpoint/Sub-Menu	Default	Range	Description
Tmp Cmp	No	No, Yes	<p>No = The standby chiller becomes operating only in the following case:</p> <ol style="list-style-type: none"> 1. At least one chiller is in alarm state. 2. At least one of the Slave chillers is in communication alarm with the Master chiller. 3. At least one chiller is not enabled. <p>Yes = The standby chiller becomes operating in all previous cases and also if the all other chillers are running at the maximum capacity and the water temperature setpoint is not reached for at least a specific time defined by the parameter Tmp Comp Time</p>
Tmp Comp Time	120 min	0...600	Time constant in which the system has to be at maximum capacity and the setpoint not reached before that the standby chiller will be enabled.

Step 5 : Reset

The reset command can be used to force the rotation of the standby chiller.

Setpoint/Sub-Menu	Default	Range	Description
-------------------	---------	-------	-------------

Standby Reset	Off	Off, Reset	Off = No Action Reset = Force a rotation of the standby chiller and reset the timer for rotation
---------------	------------	------------	---

5.10.4.3 Disconnect Mode

For each unit belonging to the Master Slave is possible activate the function Disconnect Mode through the menu 4.2.5. This function allows to disconnect temporary the unit from the network and manage it like if this unit has been configured as Standalone.

- If a slave unit is in Disconnect mode then the master considers this unit as not available.
- If the master unit is in Disconnect mode then also all other slave units are forced to work in Disconnect mode.

This function can be used to easily perform maintenance operation of one or more chillers of the network.

6 Alarms

The UC protects the unit and the components from operating in abnormal conditions. Protections can be divided in preventions and alarms. Alarms can then be divided in pump-down and rapid stop alarms. Pump-down alarms are activated when the system or sub-system can perform a normal shutdown in spite of the abnormal running conditions. Rapid stop alarms are activated when the abnormal running conditions require an immediate stop of the whole system or sub-system to prevent potential damages.

The UC displays the active alarms in a dedicated page and keep an history of the last 50 entries divided between alarms and acknowledges occurred. Time and date for each alarm event and of each alarm acknowledge are stored.

The UC also stores alarm snapshot of each alarm occurred. Each item contains a snapshot of the running conditions right before the alarm has occurred. Different sets of snapshots are programmed corresponding to unit alarms and circuit alarms holding different information to help the failure diagnosis.

6.1.1 Unit Warning Alarms

6.1.1.1 External Event

This alarm indicate that a device, whose operation is linked with this machine, is reporting a problem. This alarm can occur only if the parameter *External Alarm* is set as *Event* (see section 0)

Symptom	Cause	Solution
Unit status is Run. Bell icon is moving on controller's display. Led on the button 2 of External HMI is blinking String in the alarm list: + <i>External EventAlm</i> String in the alarm log: ± <i>External EventAlm</i> String in the alarm snapshot: <i>External Event Alm</i>	There is an external event that has caused the opening, for at least 5 seconds, of the digital input on the option module POL965 with address 18.	Check for reasons of external event and if it can be a potential problem for a correct chiller operation.

6.1.1.2 Bad Lwt Reset Input Signal

This alarm can occur only when the function Lwt Reset is enabled (see section 0). It indicates that the Lwt Reset signal input is out of admissible range

Symptom	Cause	Solution
Unit status is Run. Bell icon is moving on controller's display. Led on the button 2 of External HMI is blinking String in the alarm list: <i>+LwtResetAlm</i> String in the alarm log: <i>±LwtResetAlm</i> String in the alarm snapshot: <i>LwtReset Alm</i>	Lwt Reset input signal is out of the admissible range that is [3 - 21] mA	Check the electrical connection of the Lwt Reset signal.
		Check the device that produces the Lwt Reset signal.

6.1.1.3 Bad Demand Limit Input Signal

This alarm can occur only when the function Demand Limit is enabled (see section 0). It indicates that the Demand Limit signal input is out of admissible range

Symptom	Cause	Solution
Unit status is Run. Bell icon is moving on controller's display. Led on the button 2 of External HMI is blinking String in the alarm list: <i>+DemandLimitAlm</i> String in the alarm log: <i>±DemandLimitAlm</i> String in the alarm snapshot: <i>DemandLimit Alm</i>	Demand Limit input signal is out of the admissible range that is [3 - 21] mA	Check the electrical connection of the demand limit signal.
		Check the device that produces the demand limit signal

6.1.1.4 Heat Recovery Entering Water Temperature (HREWT) sensor fault (A/C only)

This alarm is generated any time the input resistance is out of an acceptable range.

Symptom	Cause	Solution
Unit status is Off. All circuits are stopped with a normal shutdown procedure. Bell icon is moving on controller's display. Led on the button 2 of External HMI is blinking String in the alarm list: <i>+UnitAIHREwtSen</i> String in the alarm log: <i>± UnitAIHREwtSen</i> String in the alarm snapshot: <i>UnitAIHREwtSen</i>	Sensor is broken.	Check for sensor integrity.
		Check correct sensors operation according with information about kOhm (kΩ) range related to temperature values.
	Sensor is shorted.	Check if sensor is shorted with a resistance measurement.
	Sensor is not properly connected (open).	Check for absence of water or humidity on electrical contacts.
		Check for correct plug-in of the electrical connectors on the UC.
	Check for correct sensors wiring according with wiring diagram.	

6.1.1.5 Heat Recovery Leaving Water Temperature (HREWT) sensor fault (A/C only)

This alarm is generated any time the input resistance is out of an acceptable range.

Symptom	Cause	Solution
Operation Manual 66		EWVQ - EWLQ - EWHQ EWAQ - EWYQ Air or Water cooled scroll chiller & heat pump D-EOMHW00107-15EN

Unit status is Off. All circuits are stopped with a normal shutdown procedure. Bell icon is moving on controller's display. Led on the button 2 of External HMI is blinking String in the alarm list: +UnitAIHRLwtSen String in the alarm log: ± UnitAIHRLwtSen String in the alarm snapshot: UnitAIHRLwtSen	Sensor is broken.	Check for sensor integrity.
		Check correct sensors operation according with information about kOhm (kΩ) range related to temperature values.
	Sensor is shorted.	Check if sensor is shorted with a resistance measurement.
	Sensor is not properly connected (open).	Check for absence of water or humidity on electrical contacts.
		Check for correct plug-in of the electrical connectors on the UC.
		Check for correct sensors wiring according with wiring diagram.

6.1.2 Unit Pumpdown Stop Alarms

The following alarms will stop the unit commanding a pumpdown on all running circuits. The unit will not run again until the root-cause of the alarm is not fixed.

6.1.2.1 Evaporator Entering Water Temperature (EWT) sensor fault

This alarm is generated any time the input resistance is out of an acceptable range.

Symptom	Cause	Solution
Unit status is Off. All circuits are stopped with a normal shutdown procedure. Bell icon is moving on controller's display. Led on the button 2 of External HMI is blinking String in the alarm list: +UnitOff EvpEntWTempSen String in the alarm log: ±UnitOff EvpEntWTempSen String in the alarm snapshot: UnitOff EvapEntWTemp Sen	Sensor is broken.	Check for sensor integrity.
		Check correct sensors operation according with information about kOhm (kΩ) range related to temperature values.
	Sensor is shorted.	Check if sensor is shorted with a resistance measurement.
	Sensor is not properly connected (open).	Check for absence of water or humidity on electrical contacts.
		Check for correct plug-in of the electrical connectors on the UC.
		Check for correct sensors wiring according with wiring diagram.

6.1.2.2 Evaporator Leaving Water Temperature (ELWT) sensor fault

This alarm is generated any time the input resistance is out of an acceptable range.

Symptom	Cause	Solution
Unit status is Off. All circuits are stopped with a normal shutdown procedure. Bell icon is moving on controller's display. Led on the button 2 of External HMI is blinking String in the alarm list: +UnitOff EvpLvGWTempSen String in the alarm log: ±UnitOff EvpLvGWTempSen String in the alarm snapshot: UnitOff EvapLvGWTemp Sen	Sensor is broken.	Check for sensor integrity.
		Check correct sensors operation according information about kOhm (kΩ) range related to temperature values.
	Sensor is shorted.	Check if sensor is shorted with a resistance measurement.
	Sensor is not properly connected (open).	Check for absence of water or humidity on electrical contacts.
		Check for correct plug-in of the electrical connectors.
		Check for correct sensors wiring according with wiring diagram.

6.1.2.3 Condenser Entering Water Temperature (CEWT) sensor fault (W/C only)

This alarm is generated any time the input resistance is out of an acceptable range.

Symptom	Cause	Solution
Unit status is Off. All circuits are stopped with a normal shutdown procedure. Bell icon is moving on controller's display. Led on the button 2 of External HMI is blinking String in the alarm list: +UnitOff CndEntWTempSen String in the alarm log: ±UnitOff CndEntWTempSen String in the alarm snapshot: UnitOff CndEntWTemp Sen	Sensor is broken.	Check for sensor integrity. Check correct sensors operation according information about kOhm kOhm (kΩ) range related to temperature values.
	Sensor is shorted.	Check if sensor is shorted with a resistance measurement.
	Sensor is not properly connected (open).	Check for absence of water or humidity on electrical contacts.
		Check for correct plug-in of the electrical connectors. Check for correct sensors wiring according with wiring diagram.

6.1.2.4 Condenser Leaving Water Temperature (CLWT) sensor fault (W/C only)

This alarm is generated any time the input resistance is out of an acceptable range.

Symptom	Cause	Solution
Unit status is Off. All circuits are stopped with a normal shutdown procedure. Bell icon is moving on controller's display. Led on the button 2 of External HMI is blinking String in the alarm list: +UnitOff CndLvgWTempSen String in the alarm log: ±UnitOff CndLvgWTempSen String in the alarm snapshot: UnitOff CndLvgWTemp Sen	Sensor is broken.	Check for sensor integrity. Check correct sensors operation according information about kOhm (kΩ) range related to temperature values.
	Sensor is shorted.	Check if sensor is shorted with a resistance measurement.
	Sensor is not properly connected (open).	Check for absence of water or humidity on electrical contacts.
		Check for correct plug-in of the electrical connectors. Check for correct sensors wiring according with wiring diagram.

6.1.2.5 Outside Air Temperature (OAT) sensor fault (A/C only)

This alarm is generated any time the input resistance is out of an acceptable range.

Symptom	Cause	Solution
Unit status is Off. All circuits are stopped with a normal shutdown procedure. Bell icon is moving on controller's display. Led on the button 2 of External HMI is blinking String in the alarm list: +UnitOff AmbTempSen String in the alarm log: ±UnitOff AmbTempSen String in the alarm snapshot: UnitOff AmbTemp Sen	Sensor is broken.	Check for sensor integrity. Check correct sensors operation according information about kOhm (kΩ) range related to temperature values.
	Sensor is shorted.	Check if sensor is shorted with a resistance measurement.
	Sensor is not properly connected (open).	Check for absence of water or humidity on electrical contacts.
		Check for correct plug-in of the electrical connectors. Check for correct sensors wiring according with wiring diagram.

6.1.3 Unit Rapid Stop Alarms

The unit is immediately stopped. All the running circuits will stop rapidly without performing the normal shutdown procedure.

6.1.3.1 EXV drive circuit #1/#2 communication fail alarm (W/C only)

This alarm is generated in case of communication problems with the EXV driver of circuit #1 or circuit #2 identified respectively with labels EEXV-1 and EEXV-2.

Symptom	Cause	Solution
Unit status is Off. All circuits are stopped immediately. Bell icon is moving on controller's display. Led on the button 2 of External HMI is blinking String in the alarm list: +Unit Off Exv*CtrlCommFail String in the alarm log: ±Unit Off Exv*CtrlCommFail String in the alarm snapshot: Unit Off Exv*CtrlCommFail	Module has no power supply	Check the power supply from the connector on the side of the module. Check if LEDs are both green.
	Module address is not properly set	Check if the connector on the side is tightly inserted in the module Check if module's address is correct referring to the wiring diagram.
	Module is broken	Check if LED are on and both green. If BSP LED is solid red replace the module
		Check if power supply is ok but LEDs are both off. In this case replace the module

* refers to either driver #1 or driver #2

6.1.3.2 Options controller communication fail alarm

This alarm is generated in case of communication problems with the module for optional functions. POL965 with address 18. This alarm can occur only if at least one of the optional functions is enabled (PVM, External Alarm, Demand Limit, LWT Reset; see section 0)

Symptom	Cause	Solution
Unit status is Off. All circuits are stopped immediately. Bell icon is moving on controller's display. Led on the button 2 of External HMI is blinking String in the alarm list: +Unit Off OptCtrlrComFail String in the alarm log: ±Unit Off OptCtrlrComFail String in the alarm snapshot: Unit Off OptCtrlrComFail	Module has no power supply	Check the power supply from the connector on the side of the module. Check if LEDs are both green.
	Module address is not properly set	Check if the connector on the side is tightly inserted in the module Check if module's address is correct referring to the wiring diagram.
	Module is broken	Check if LED are on and both green. If BSP LED is solid red replace the module
		Check if power supply is ok but LEDs are both off. In this case replace the module

6.1.3.3 Phase Voltage Monitor alarm



Resolution of this fault requires a direct intervention on the power supply of this unit. Direct intervention on the power supply can cause electrocution, burns or even death. This action must be performed only by trained persons. In case of doubts contact your maintenance company.

This alarm is generated in case of problems with the power supply to the chiller. This alarm can occur only if the PVM is enabled (see section 4.9.1)

EWWQ - EWLQ - EWHQ EWAQ - EWYQ Air or Water cooled scroll chiller & heat pump D-EOMHW00107-15EN		Operation Manual 69
--	--	------------------------

Symptom	Cause	Solution
Unit status is Off. All circuits are stopped immediately. Bell icon is moving on controller's display. Led on the button 2 of External HMI is blinking String in the alarm list: +UnitOff PvmGfpAlm String in the alarm log: ± UnitOff PvmGfpAlm String in the alarm snapshot: UnitOff PvmGfp Alm	Loss of one phase.	Check voltage level on each of the phases.
	Not correct sequence connection of L1,L2,L3.	Check sequence of L1, L2, L3 connections according indication on chiller's electrical scheme.
	Voltage level on the unit's panel is not in the allowed range (±10%).	Check that voltage level on each phases is into the allowed range that is indicated on the chiller label. It is important to check the voltage level on each phases not only with chiller not running, but mainly with chiller running from minimum capacity up to full load capacity. That's because voltage drop can occur from a certain unit cooling capacity level, or because of certain working condition (i.e. high values of OAT); In these cases the issue can be related with the sizing of power cables.
	There is a short-circuit on the unit.	Check for correct electrical isolation condition of each unit's circuit with a Megger tester.

6.1.3.4 Evaporator Flow Loss alarm

This alarm is generated in case of flow loss on the evaporator. This alarm protect the evaporator against:

- Freezing: when unit works as chiller or as heat pump with water inversion
- High Pressure: when unit works as heat pump with gas inversion

Symptom	Cause	Solution
Unit status is Off. All circuits are stopped immediately. Bell icon is moving on controller's display. Led on the button 2 of External HMI is blinking String in the alarm list: +UnitOff EvpFlwAlm String in the alarm log: ± UnitOff EvpFlwAlm String in the alarm snapshot: UnitOff EvpFlw Alm	No evaporator water flow sensed or water flow too low.	Check the evaporator water pump filler and the water circuit for obstructions.
		Check the evaporator flow switch calibration and adapt to minimum water flow.
		Check if evaporator pump impeller can rotate freely and it has no damages.
		Check evaporator pumps protection devices (circuit breakers, fuses, inverters, etc.)
		Check evaporator flow switch connections.

6.1.3.5 Condenser Flow Loss alarm (W/C only)

This alarm is generated in case of water flow loss to the condenser. This alarm protect the condenser against:

- Freezing: when unit works as heat pump with gas inversion
- High Pressure: when unit works as chiller or as heat pump with water inversion

Symptom	Cause	Solution
Operation Manual 70		EWWQ - EWLQ - EWHQ EWAQ - EWYQ Air or Water cooled scroll chiller & heat pump D-EOMHW00107-15EN

Unit status is Off. All circuits are stopped immediately. Bell icon is moving on controller's display. Led on the button 2 of External HMI is blinking String in the alarm list: +UnitOff CndFlwAlm String in the alarm log: ± UnitOff CndFlwAlm String in the alarm snapshot: UnitOff CndFlw Alm	No condenser water flow sensed continuously or water flow too low.	Check the condenser water pump filler and the water circuit for obstructions.
		Check the condenser flow switch calibration and adapt to minimum water flow.
		Check if condenser pump impeller can rotate freely and it has no damages.
		Check condenser pumps protection devices (circuit breakers, fuses, inverters, etc.)
		Check condenser flow switch connections.

6.1.3.6 Evaporator Water Freeze Protect alarm

This alarm is generated to indicate that the evaporator (entering or leaving) water temperature has dropped below a safety limit.

Symptom	Cause	Solution
Unit status is Off. All circuits are stopped immediately. Bell icon is moving on controller's display. String in the alarm list: +UnitOff EvpFreezeAlm String in the alarm log: ±UnitOff EvpFreezeAlm String in the alarm snapshot: UnitOff EvpFreeze Alm	Water flow too low.	Increase the water flow.
	Inlet temperature to the evaporator is too low.	Increase the inlet water temperature.
	Flow switch is not working or no water flow.	Check the flow switch and the water pump.
	Refrigerant temperature become too low (< -0.6°C).	Check the water flow and filter. No good heat exchange conditions into the evaporator.
	Sensors temperature readings (entering or leaving) are not properly calibrated	Check the water temperatures with a proper instrument and adjust the sensor offsets

6.1.3.7 Condenser Water Freeze Protect alarm

This alarm is generated to indicate that the condenser (entering or leaving) water temperature has dropped below a safety limit.

Symptom	Cause	Solution
Unit status is Off. All circuits are stopped immediately. Bell icon is moving on controller's display. String in the alarm list: +UnitOff CondFreezeAlm String in the alarm log: ±UnitOff CondFreezeAlm String in the alarm snapshot: UnitOff CondFreeze Alm	Water flow too low.	Increase the water flow.
	Inlet temperature to the condenser is too low.	Increase the inlet water temperature.
	Flow switch is not working or no water flow.	Check the flow switch and the water pump.
	Refrigerant temperature become too low (< -0.6°C).	Check the water flow and filter. No good heat exchange condition into the evaporator.
	Sensors temperature readings (entering or leaving) are not properly calibrated	Check the water temperatures with a proper instrument and adjust the sensor offsets

6.1.3.8 External alarm

This alarm is generated to indicate that an external device whose operation is linked with this unit operation. This alarm can occur only if the parameter *External Alarm* is set to *Alarm* (see section 0)

EWWQ - EWLQ - EWHQ EWAQ - EWYQ Air or Water cooled scroll chiller & heat pump D-EOMHW00107-15EN		Operation Manual 71
--	--	------------------------

Symptom	Cause	Solution
Unit status is Off. All circuits are stopped immediately. Bell icon is moving on controller's display. Led on the button 2 of External HMI is blinking String in the alarm list: <i>UnitOff ExternalAlm</i> String in the alarm log: <i>± UnitOff ExternalAlm</i> String in the alarm snapshot: <i>UnitOff External Alm</i>	There is an external alarm that has caused the opening, for at least 5 seconds, of the port on the option module POL965 with address 18.	Check causes of the external alarm. Check electrical wiring from unit controller to the external equipment in case of any external events or alarms have been occurred.

6.1.4 Master Slave Alarm

The following alarms are related to the function Master Slave.

6.1.4.1 Common Evaporator Leaving Water Temperature sensor fault

This alarm can occurs when the sensor used to measure the common leaving water temperature is broken or not connected to the chiller defined master.

Symptom	Cause	Solution
Every unit in the Master Slave Network works in local mode. Bell icon is moving on master controller's display. Led on the button 2 of the master External HMI is blinking String in the alarm list: <i>+Common LWTSen</i> String in the alarm log: <i>±Common LWTSen</i> String in the alarm snapshot: <i>Common LWTSen</i>	Sensor is broken.	Check for sensor integrity. Check correct sensors operation according information about kOhm (kΩ) range related to temperature values.
	Sensor is shorted.	Check if sensor is shorted with a resistance measurement.
	Sensor is not properly connected (open).	Check for absence of water or humidity on electrical contacts.
		Check for correct plug-in of the electrical connectors. Check for correct sensors wiring according with wiring diagram.

6.1.4.2 Slave X Communication Alarm

This alarm displayed only on the Master unit and occurs every time that there is communication error between Master and Slave.

Symptom	Cause	Solution
The Slave unit works in local mode. Bell icon is moving on master controller's display. Led on the button 2 of the master External HMI is blinking String in the alarm list: <i>+Slave X CommAlm</i> String in the alarm log: <i>± Slave X CommAlm</i> String in the alarm snapshot: <i>Slave X CommAlm</i>	Cable broken	Check for cable integrity
	Connection wrong	Check the polarity +/- of the connection cable between Master and Slave

6.1.4.3 Master Communication Alarm

This alarm, dual to the previous, displayed only on the Slave unit occurs every time that there is communication error between Master and Slave.

Symptom	Cause	Solution
The Slave unit works in local mode. Bell icon is moving on Slave controller's display. Led on the button 2 of the Slave External HMI is blinking String in the alarm list: <i>+Master CommAlm</i> String in the alarm log: <i>± Master CommAlm</i> String in the alarm snapshot: <i>Master CommAlm</i>	Cable broken	Check for cable integrity
	Connection wrong	Check the polarity +/- of the connection cable between Master and Slave

6.1.4.4 Slave X Missing

This alarm displayed on the Master unit occurs when there is a configuration error in the function Master Slave

Symptom	Cause	Solution
All system Master Slave cannot start Bell icon is moving on Master controller's display. Led on the button 2 of the Master External HMI is blinking String in the alarm list: <i>+Slave X Missing</i> String in the alarm log: <i>± Slave X Missing</i> String in the alarm snapshot: <i>Slave X Missing</i>	There is more than one unit configured with the same address and consequently the address in alarm is not configured	Check all address assigned to each unit of the master slave network
	The parameter "M/S Num of Unit" is set incorrectly	Verify that the number of unit set in this parameter is the same of the number of unit that really belong to the Master Slave network

6.1.4.5 Master Missing

This alarm displayed on the Slave unit occurs when there is a configuration error in the function Master Slave

Symptom	Cause	Solution
All system Master Slave cannot start Bell icon is moving on Slave controller's display. Led on the button 2 of the Slave External HMI is blinking String in the alarm list: <i>+Slave X Missing</i> String in the alarm log: <i>± Slave X Missing</i> String in the alarm snapshot: <i>Slave X Missing</i>	There is more than one unit configured with the same address and consequently the address in alarm is not configured	Check all address assigned to each unit of the master slave network
	The parameter "M/S Num of Unit" is set incorrectly	Verify that the number of unit set in this parameter is the same of the number of unit that really belong to the Master Slave network

6.1.5 Circuit Warning Alarms

The following alarms will stop the circuit immediately but will allow the circuit to restart when the anti-recycle timers are expired.

6.1.5.1 Low Outside Ambient Temperature At Start Alarm

This alarm can occur only if the condenser less unit type is configured or if the unit is A/C (see section 0). It indicates that the circuit is starting with low outside ambient temperature.

Symptom	Cause	Solution
Circuit status is Off. The circuit is stopped. Bell icon is moving on controller's display. Led on the button 2 of External HMI is blinking String in the alarm list: +Cx LowOatStartAlm String in the alarm log: ± Cx LowOatStartAlm String in the alarm snapshot: Cx LowOatStart Alm	Low outside ambient temperature	Check the operating condition of the condenser-less unit.
	Refrigerant charge low.	Check sight glass on liquid line to see if there is flash gas. Measure sub-cooling to see if the refrigerant charge is correct.

6.1.5.2 Failed Pumpdown

This alarm is generated to indicate that the circuit hadn't been able to remove all the refrigerant from the evaporator.

Symptom	Cause	Solution
Circuit status is Off. Led on the button 2 of External HMI is blinking String in the alarm list: +Cx FailedPumpdownAlm String in the alarm log: ± Cx FailedPumpdownAlm String in the alarm snapshot: Cx FailedPumpdown Alm	EEXV is not closing completely, therefore there's "short-circuit" between high pressure side with low pressure side of the circuit.	Check for proper operation and full closing position of EEXV. Sight glass should not show refrigerant flow after the valve is closed. Check that the C-LED on the EXV driver is solid green. If both LEDs on the EXV driver are blinking alternately the valve motor is not properly connected.
	Evaporating pressure sensor is not working properly.	Check for proper operation of evaporating pressure sensor.
	Compressor on circuit is internally damaged with a mechanical problems for example on internal check-valve, or on internal spirals or vanes.	Check compressors on circuits.

6.1.5.3 Failed Pumpdown in High Pressure (A/C only)

This alarm is generated to indicate that the circuit hadn't been able to remove all the refrigerant from the evaporator before getting too close to the High Pressure alarm limit. In this case the pumpdown is finished before the pumpdown pressure target is reached.

Symptom	Cause	Solution
Circuit status is Off. Led on the button 2 of External HMI is blinking String in the alarm list: +Cx FailedPumpdownHiPr String in the alarm log:	Excessive refrigerant charge	Verify the refrigerant charge by checking the subcooling

± Cx FailedPumpdownHiPr String in the alarm snapshot: Cx FailedPumpdownHiPr		
---	--	--

6.1.6 Circuit Pumpdown Stop Alarms

The circuit is stopped with the normal pumpdown procedure. It will not be allowed to start again until the root-cause of the alarm is fixed.

6.1.6.1 Suction Temperature Sensor fault

This alarm is generated to indicate that the sensor is not reading properly.

Symptom	Cause	Solution
Circuit status is Off. The circuit is switched off with the normal shutdown procedure. Bell icon is moving on controller's display. String in the alarm list: +CxOff SuctTempSen String in the alarm log: ± CxOff SuctTempSen String in the alarm snapshot: CxOff SuctTemp Sen	Sensor is shorted.	Check for sensor integrity.
		Check correct sensors operation according information about kOhm (kΩ) range related to temperature values.
	Sensor is broken.	Check if sensor is shorted with a resistance measurement.
	Sensor is not good connected (open).	Check for correct installation of the sensor on refrigerant circuit pipe.
		Check for absence of water or humidity on sensor electrical contacts.
		Check for correct plug-in of the electrical connectors.
		Check for correct sensors wiring also according with electrical scheme.

6.1.6.2 Discharge Temperature Sensor fault (A/C only)

This alarm is generated to indicate that the sensor is not reading properly.

Symptom	Cause	Solution
Circuit status is Off. The circuit is switched off with the normal shutdown procedure. Bell icon is moving on controller's display. String in the alarm list: +CxOff DischTempSen String in the alarm log: ± CxOff DischTempSen String in the alarm snapshot: CxOff DischTemp Sen	Sensor is shorted.	Check for sensor integrity.
		Check correct sensors operation according information about kOhm (kΩ) range related to temperature values.
	Sensor is broken.	Check if sensor is shorted with a resistance measurement.
	Sensor is not good connected (open).	Check for correct installation of the sensor on refrigerant circuit pipe.
		Check for absence of water or humidity on sensor electrical contacts.
		Check for correct plug-in of the electrical connectors.
		Check for correct sensors wiring also according with electrical scheme.

6.1.7 Circuit Rapid Stop Alarms

The circuit is immediately stopped to prevent damages to the components. The circuit will not be allowed to run again until the root-cause of the alarm is fixed.

6.1.7.1 EXV drive circuit #1/#2 communication fail alarm (A/C only)

This alarm is generated in case of communication problems with the EXV driver of circuit #1 or circuit #2 identified respectively with labels EEXV-1 and EEXV-2.

EWWQ - EWLQ - EWHQ EWAQ - EWYQ Air or Water cooled scroll chiller & heat pump D-EOMHW00107-15EN		Operation Manual 75
--	--	-------------------------------

Symptom	Cause	Solution
Unit status is Auto. The circuit is stopped immediately. Bell icon is moving on controller's display. Led on the button 2 of External HMI is blinking String in the alarm list: <i>+C*Off EXVCtrlrComFail</i> String in the alarm log: <i>± C*Off EXVCtrlrComFail</i> String in the alarm snapshot: <i>C*Off EXVCtrlrComFail</i>	Module has no power supply	Check the power supply from the connector on the side of the module. Check if LEDs are both green. Check if the connector on the side is tightly inserted in the module
	Module address is not properly set	Check if module's address is correct referring to the wiring diagram.
	Module is broken	Check if LED are on and both green. If BSP LED is solid red replace the module
		Check if power supply is ok but LEDs are both off. In this case replace the module

* refers to either driver #1 or driver #2

6.1.7.2 Low Pressure alarm

This alarm is generated if the evaporating pressure drops below the Low Pressure Unload and the control is not able to compensate this condition.

Symptom	Cause	Solution
Circuit status is Off. The compressor does not load anymore or even unload, circuit is stopped immediately. Bell icon is moving on controller's display. Led on the button 2 of External HMI is blinking String in the alarm list: <i>+Cx Off EvapPressLo</i> String in the alarm log: <i>± Cx Off EvapPressLo</i> String in the alarm snapshot: <i>Cx Off EvapPress Lo</i>	Refrigerant charge is low.	Check sight glass on liquid line to see if there is flash gas. Measure sub-cooling to see if the refrigerant charge is correct.
	Protection limit not set to fit customer application.	Check the evaporator approach and the corresponding water temperature setpoint to evaluate the low pressure hold limit.
	High Evaporator Approach.	Clean the evaporator Check the quality of the fluid that flows into heat exchanger. Check the glycol percentage and type (ethilenic or propilenic)
	Water flow into water heat exchanger is too low (W/C only).	Increase the water flow. Check the minimum water flow for this unit.
	Evaporating pressure transducer is not working properly.	Check the sensor for proper operation and calibrate the readings with a gauge.
	EEXV is not working correctly. It's not opening enough or it's moving in the opposite direction.	Check if pump-down can be finished for pressure limit reached.
		Check valve movements.
		Check connection to the valve driver on the wiring diagram. Measure the resistance of each winding, it has to be different from 0 Ohm.
	Water temperature is low	Increase inlet water temperature.
	Default alarm limit not valid for the specific plant	Adjust the low pressure alarm settings.
Fans do not operate properly (A/C H/P only)	Check Fans operation. Check that all the fans can run freely and at the proper speed.	

	Check the phase cut device.
--	-----------------------------

6.1.7.3 High Pressure alarm

This alarm is generated if the condensing pressure rise above the Hi Press Stop limit.

Symptom	Cause	Solution
Circuit status is Off. The compressor does not load anymore or even unload, circuit is stopped. Bell icon is moving on controller's display. Led on the button 2 of External HMI is blinking String in the alarm list: +Cx Off CndPressHi String in the alarm log: ± Cx Off CndPressHi String in the alarm snapshot: Cx Off CndPress Hi	The condenser pump does not operate properly. (W/C only)	Check if condenser pump protections have been activated.
	Condenser water flow too low (W/C or H/P only)	Check the minimum water flow admitted
	Inlet water temperature of the condenser is too high. (W/C only)	The water temperature measured at the inlet of the condenser may not exceed the limit indicated in the operational range (working envelope) of the chiller.
	Excessive charge of refrigerant into the unit.	Check liquid sub-cooling and suction super-heat to control indirectly the correct charge of refrigerant. If necessary recover all the refrigerant to weight the entire charge and to control if the value is in line with kg indication on unit label.
	Condensing pressure transducer could not operate properly.	Check for proper operation of the high pressure sensor.
	Fans do not operate properly (A/C only)	Check Fans operation. Check that all the fans can run freely and at the proper speed. Check the phase cut device.

6.1.7.4 Low Delta Pressure Alarm (A/C only)

This alarm is generated if the pressure difference between condensing and evaporating pressure is below a minimum Delta Pressure limit for more than 10 minutes.

Symptom	Cause	Solution
Circuit status is Off. The compressor does not load anymore or even unload, circuit is stopped. Bell icon is moving on controller's display. Led on the button 2 of External HMI is blinking String in the alarm list: +CxOff DeltaPressLo String in the alarm log: ± CxOff DeltaPressLo String in the alarm snapshot: CxOff CxOff DeltaPressLo	Compressors are not running	Check the starter signals to compressors. Check if the Thermal protection of compressors is properly connected to the UC (see section 6.1.7.5). Check if the Mechanical High Pressure Switch is properly connected to the UC (see section 6.1.7.5).
	Condenser Pressure Transducer is not working properly	Refer to section 6.1.7.10 for further details.
	Evaporator Pressure Transducer is not working properly	Refer to section 6.1.7.9 for further details.

6.1.7.5 Circuit X Alarm

This alarm is generated when the digital input DI1 on the EXV driver of the related circuit is open. This digital input collects a series of alarm signals coming from different protection devices:

1. Mechanical High Pressure Switch
2. Compressor 1 Circuit X Thermal Protection/Soft Starter Failure
3. Compressor 2 Circuit X Thermal Protection/Soft Starter Failure
4. Phase cut device failure (A/C only)

EWWQ - EWLQ - EWHQ EWAQ - EWYQ Air or Water cooled scroll chiller & heat pump D-EOMHW00107-15EN		Operation Manual 77
--	--	------------------------

This means that this alarm is generated if at least one of the previous digital contact is open. When this happens an immediate shutdown of the compressors and all the other actuators in this circuit is commanded.

Symptom	Cause	Solution
Circuit status is Off. The compressor does not load anymore or even unload, circuit is stopped. Bell icon is moving on controller's display. Led on the button 2 of External HMI is blinking String in the alarm list: +CxOff CircAlm String in the alarm log: ± CxOff CircAlm String in the alarm snapshot: CxOff Circ Alm	Mechanical High Pressure Switch (MHPS) open	Perform same check of the High Pressure Alarm 6.1.7.3
		MHPS damaged or not calibrated. Check for correct plug-in of the electrical connectors.
		Check for proper operation of the high pressure switch.
	Compressor 1/2 Thermal Protection open	Excessive charge of refrigerant. Check liquid sub-cooling and suction super-heat to control indirectly the correct charge of refrigerant
		Check the correct operation of the electronic expansion valve. Blocked valve can impede the correct refrigerant flow.
	Compressor 1/2 Soft Starter Failure	Check Alarm code on the Soft Starter and refer to the related documentation to fix the alarm.
Check the size of the Soft Starter compared with the associated compressor maximum current.		

6.1.7.6 Start Fail Alarm

This alarm can occur only if the condenser less unit type is configured (see section 0). This alarm is generated just the UC recognizes a low evaporating pressure and a low saturated condensing temperature at the starting of the circuit. This alarm is auto-reset just occurs, as the unit tries automatically to restart the circuit. At the third occurrence of this failure a Restart Fault Alarm is generated (see alarm 6.1.7.7).

Symptom	Cause	Solution
Circuit status is Off. The circuit is stopped. Bell icon is moving on controller's display. Led on the button 2 of External HMI is blinking String in the alarm list: +Cx StartFailAlm String in the alarm log: ± Cx StartFailAlm String in the alarm snapshot: Cx StartFail Alm	Low outside ambient temperature	Check the operating condition of the condenser-less unit
	Refrigerant charge low.	Check sight glass on liquid line to see if there is flash gas.
		Measure sub-cooling to see if the refrigerant charge is correct.
	Condensing Setpoint not correct for the application	Check if necessary to increase the condensing saturated temperature setpoint
	Dry cooler not correctly installed	Check that the dry cooler is safe from strong wind
Evaporator or condensing sensor pressure broken or not correctly installed	Check the proper operation of the pressure transducers.	

6.1.7.7 Restart Fault Alarm

This alarm can occur only if the condenser less unit type is configured. This alarm is generated if for three times the UC recognizes a low evaporating pressure and a low saturated condensing temperature at the starting of the circuit.

Symptom	Cause	Solution
Circuit status is Off. The circuit is stopped. Bell icon is moving on controller's display. Led on the button 2 of External HMI is blinking String in the alarm list: +Cx Off RestrtsFaultAlm String in the alarm log: ± Cx Off RestrtsFaultAlm String in the alarm snapshot: Cx Off RestrtsFault Alm	Low outside ambient temperature	Check the operating condition of the condenser-less unit
	Refrigerant charge low.	Check sight glass on liquid line to see if there is flash gas.
		Measure sub-cooling to see if the refrigerant charge is correct.
	Condensing Setpoint not correct for the application (W/C only)	Check if necessary to increase the condensing saturated temperature setpoint
	Dry cooler not correctly installed (W/C only)	Check that the dry cooler is safe from strong wind
Evaporator or condensing sensor pressure broken or not correctly installed	Check the proper operation of the pressure transducers.	

6.1.7.8 No Pressure Change At Start alarm

This alarm indicates that the compressor is not able to start or it is not able to create a minimum variation of the evaporating or condensing pressures after start.

Symptom	Cause	Solution
Circuit status is Off. The circuit is stopped. Bell icon is moving on controller's display. Led on the button 2 of External HMI is blinking String in the alarm list: +Cx Off NoPressChgStartAlm String in the alarm log: ± Cx Off NoPressChgStartAlm String in the alarm snapshot: Cx Off NoPressChgStart Alm	Compressor cannot start	Check if the start signal is properly connected to the compressor.
	Compressor is turning in wrong direction.	Check correct phases sequence to the compressor (L1, L2, L3) according to the electrical scheme.
	Refrigerant circuit is empty of refrigerant.	Check circuit pressure and presence of refrigerant.
	Not proper operation of evaporating or condensing pressure transducers.	Check proper operation of evaporating or condensing pressure transducers.

6.1.7.9 Evaporating Pressure sensor fault

This alarm indicates that the evaporating pressure transducer is not operating properly.

Symptom	Cause	Solution
Circuit status is Off. The circuit is stopped. Bell icon is moving on controller's display. Led on the button 2 of External HMI is blinking String in the alarm list: +CxOff EvapPressSen String in the alarm log: ± CxOff EvapPressSen String in the alarm snapshot:	Sensor is broken.	Check for sensor integrity. Check correct sensors operation according information about mVolt (mV) range related to pressure values in kPa..
	Sensor is shorted.	Check if sensor is shorted with a resistance measurement.
	Sensor is not properly connected (open).	Check for correct installation of the sensor on refrigerant circuit pipe. The transducer must be able to sense the pressure through the valve's needle.

<i>Cx Off EvapPress Sen</i>	Check for absence of water or humidity on sensor electrical contacts.
	Check for correct plug-in of the electrical connectors.
	Check for correct sensors wiring also according electrical scheme.

6.1.7.10 Condensing Pressure sensor fault

This alarm indicates that the condensing pressure transducer is not operating properly.

Symptom	Cause	Solution
Circuit status is Off. The circuit is stopped. Bell icon is moving on controller's display. Led on the button 2 of External HMI is blinking String in the alarm list: <i>+CxOff CndPressSen</i> String in the alarm log: <i>± CxOff CndPressSen</i> String in the alarm snapshot: <i>Cx Off CondPress Sen</i>	Sensor is broken.	Check for sensor integrity. Check correct sensors operation according information about mVolt (mV) range related to pressure values in kPa.
	Sensor is shorted.	Check if sensor is shorted with a resistance measurement.
	Sensor is not properly connected (open).	Check for correct installation of the sensor on refrigerant circuit pipe. The transducer must be able to sense the pressure through the valve's needle. Check for absence of water or humidity on sensor electrical contacts.
		Check for correct plug-in of the electrical connectors.
		Check for correct sensors wiring also according electrical scheme.

This page has been left intentionally free

For more information email info@daikinapplied.uk or visit www.daikinapplied.uk

For all Daikin Applied UK,
Daikin Applied Service &
Spares enquiries call us on:
0345 565 2700



Daikin Europe N.V. participates in the Eurovent Certified Performance programme for Liquid Chilling Packages and Hydronic Heat Pumps, Fan Coil Units and Variable Refrigerant Flow systems. Check ongoing validity of certificate:
www.eurovent-certification.com

The present publication is drawn up by way of information only and does not constitute an offer binding upon Daikin Europe N.V. Daikin Europe N.V. has compiled the content of this publication to the best of its knowledge. No express or implied warranty is given for the completeness, accuracy, reliability or fitness for particular purpose of its content and the products and services presented therein. Specifications are subject to change without prior notice. Daikin Europe N.V. explicitly rejects any liability for any direct or indirect damage, in the broadest sense, arising from or related to the use and/or interpretation of this publication. All content is copyrighted by Daikin Europe N.V.

