

Applied Systems
Technical Data

FWM-DAT/DAF



- > FWM01DAFV3
- > FWM15DAFV3
- > FWM02DAFV3
- > FWM25DAFV3
- > FWM03DAFV3
- > FWM04DAFV3

- > FWM06DAFV3
- > FWM35DAFV3
- > FWM08DAFV3
- > FWM10DAFV3
- > FWM15DATV3
- > FWM01DATV3

- > FWM02DATV3
- > FWM25DATV3
- > FWM03DATV3
- > FWM35DATV3
- > FWM04DATV3
- > FWM06DATV3

TABLE OF CONTENTS

FWM-DAT/DAF

1	Features	2
	FWM-DAT	2
2	Specifications	3
	Technical Specifications	3
	Electrical Specifications	5
3	Options	7
4	Control systems	9
5	Capacity tables	10
	Cooling Capacity Tables - 2-pipe	10
	Cooling Capacity Tables - 4-pipe	14
	Heating Capacity Tables - 2-pipe	18
	Heating Capacity Tables - 4-pipe	21
	Cooling Capacity Tables Glycol 30 %	23
	Capacity Correction Factor	24
6	Power consumption	25
	Power Consumption - 2-pipe	25
	Power Consumption - 4-pipe	30
7	Dimensional drawings	35
8	Wiring diagrams	36
	Wiring Diagrams - Single Phase	36
9	Sound data	37
	Sound Level Data - 2-pipe	37
	Sound Level Data - 4-pipe	38
10	Installation	39
	Installation Method	39
11	Operation range	41
12	Hydraulic performance	42
	Water Pressure Drop Curve Evaporator - Cooling 2-pipe	42
	Water Pressure Drop Curve Evaporator - Heating 2-pipe	43
	Water Pressure Drop Curve Evaporator - Heating 4-pipe	44

1 Features

1 - 1 FWM-DAT

- Pre-assembled 3-way/4-port on/off valves are available
- Valve packages are insulated, no extra drain pan required
- Valve packages contain balancing valves and sensor pocket
- Fast-on connections for electrical options: no tools needed
- Electric heater: no relay up to 2kW capacity
- Electric heater: equipped with two overheat cut-out thermostats

2 Specifications

2-1 Technical Specifications				FW	FW	FW	FW	FW	FW	FW	FW	FW	FW	FW	FW	FW	FW	FW	FW	FW	FW	FW		
				M0	M1	M0	M2	M0	M0	M0	M0	M3	M0	M1	M1	M0	M0	M2	M0	M3	M0	M0	M0	M0
				1D	5D	2D	5D	3D	4D	6D	5D	8D	0D	5D	1D	2D	5D	3D	5D	4D	6D	8D	0D	
				AF	AF	AF	AF	AF	AF	AF	AF	AF	AF	AF	AF	AF	AF	AF	AF	AF	AF	AF	AF	
Cooling capacity (standard conditions)	Latent capacity 2-pipe	High	kW	-										0.44	0.34	0.54 (1)			0.82	0.76	1.18	0.98	1.80	2.06
	Latent capacity 4-pipe	High	kW	0.32	0.42	0.33	0.53	0.80	1.17	1.19	0.75	1.79	2.03	-										
	Sensible capacity 2-pipe	Low	kW	-										0.93	0.77	0.98	1.15	1.23	1.41	1.76	2.27	2.75	2.94	
		Medium	kW	-										1.10	0.94	1.20	1.53	1.66	1.99	2.39	3.85	4.70	4.46	
		High	kW	-										1.25	1.16	1.37	1.82	2.05	2.69	3.05	5.55	7.73	7.72	
	Sensible capacity 4-pipe	Low	kW	0.73	0.91	0.96	1.14	1.21	1.74	2.23	1.40	2.73	2.91	-										
		Medium	kW	0.87	1.07	1.18	1.50	1.62	2.36	3.80	1.96	3.67	4.40	-										
		High	kW	1.10	1.22	1.41	1.79	2.01	2.99	4.47	2.61	4.67	5.61	-										
	Total capacity 2-pipe	Low	kW	-										1.24	1.02	1.34	1.57	1.73	1.94	2.47	2.95	3.88	4.00	
Medium		kW	-										1.48	1.21	1.66	1.99	2.34	2.58	3.21	5.59	6.14	6.07		
High		kW	-										1.69	1.50	1.91	2.36	2.87	3.45	4.23	6.41	7.53	7.78		
Total capacity 4-pipe	Low	kW	0.97	1.22	1.24	1.55	1.70	2.44	3.06	1.92	3.84	3.96	-											
	Medium	kW	1.11	1.44	1.52	1.96	2.29	3.17	3.74	2.54	5.10	5.99	-											
	High	kW	1.42	1.64	1.74	2.32	2.81	4.16	4.57	3.36	6.46	7.64	-											
Heating capacity (standard conditions)	Capacity 2-pipe	Low	kW	-										1.45	1.21	1.50	1.74	1.76	2.39	2.47	3.31	3.97	3.97	
		Medium	kW	-										1.72	1.48	1.81	2.26	2.37	3.13	3.24	4.08	5.17	5.53	
		High	kW	-										1.84	1.82	2.15	2.70	2.94	4.05	4.24	6.98	8.49	8.37	
	Capacity 4-pipe	Low	kW	1.31	1.36 (3)		1.78	1.88	2.73	3.55	2.82	5.02	4.85	-										
		Medium	kW	1.49	1.56 (3)		2.18	2.31	3.22	4.07	3.47	6.02	6.29	-										
		High	kW	1.66	1.76 (3)		2.53	2.68	3.82	4.64	4.20	7.97	8.35	-										

2 Specifications

2

2-1 Technical Specifications				FW M0 1D AF	FW M1 5D AF	FW M0 2D AF	FW M2 5D AF	FW M0 3D AF	FW M0 4D AF	FW M0 6D AF	FW M0 5D AF	FW M3 8D AF	FW M0 0D AF	FW M1 5D AT	FW M0 1D AT	FW M0 2D AT	FW M2 5D AT	FW M0 3D AT	FW M3 5D AT	FW M0 4D AT	FW M0 6D AT	FW M0 8D AT	FW M1 0D AT												
Power input	Low	kW	0.02	0.03	0.02	0.03		0.04	0.05	0.04	0.09	0.11	0.03	0.02		0.03		0.04		0.05	0.09	0.11													
	Medium	kW	0.03	0.04				0.06	0.07	0.05	0.13	0.17	0.04	0.03		0.04		0.05	0.06	0.07	0.13	0.17													
	High	kW	0.037	0.053		0.057	0.056	0.098		0.05	0.18	0.24	0.03	0.03	0.03	0.03	0.03	0.03	0.03	0.098		0.182	0.244												
FCEER				E				D				E				D	E	D	E																
FCCOP				E				D				E				D	E																		
Dimensions	Unit	Height	mm	535																															
		Width	mm	584				794				1,000				1,210				584				794				1,000				1,210			
		Depth	mm	224								249								224								249							
Weight	Unit	kg	16.5	16.9	21.4	22.1	26.4	26.6	26.3	35.4				16.5	16.9	21.4	22.1	26.4	26.6	26.3	35.4														
Heat exchanger	Type		Cross fin coil																																
	Rows	Quantity	2	3	2	3				2	3				2	3	2	3	2	3															
	Fin	Type	Aluminium																																
	Tube material	Copper																																	
	Water volume	l	0	1				2				0	1				2																		
Additional heat exchanger	Rows	Quantity	1																																
	Water volume	l	0				1				-																								
Water flow	Cooling	Low	l/h	169	212	216	272	297	425	535	336	676	699	216	179	234	275	302	340	431	515	682	706												
				(1)	(1)	(1)	(1)	(1)	(1)	(1)	(1)	(1)	(1)	(1)	(1)	(1)	(1)	(1)	(1)	(1)	(1)	(1)	(1)	(1)											
				196	254	267	343	400	554	654	447	898	1058	261	213	292	348	408	458	561	628	908	1071	11											
		(1)	(1)	(1)	(1)	(1)	(1)	(1)	(1)	(1)	(1)	(1)	(1)	(1)	(1)	(1)	(1)	(1)	(1)	(1)	(1)	(1)	(1)												
		250	291	307	409	493	730	805	592	1138	1359	294	267	337	415	503	603	743	774	1154	1376	1526	11												
		(1)	(1)	(1)	(1)	(1)	(1)	(1)	(1)	(1)	(1)	(1)	(1)	(1)	(1)	(1)	(1)	(1)	(1)	(1)	(1)	(1)	(1)												
	Heating	Low	l/h	115	120	119	156	165	238	317	247	440	425	252	211	260	302	301	415	430	570	690	764												
				(3)	(3)	(3)	(3)	(3)	(3)	(3)	(3)	(3)	(3)	(3)	(3)	(3)	(3)	(3)	(3)	(3)	(3)	(3)	(3)												
				130	137	136	191	202	287	350	304	527	551	300	256	315	393	408	548	563	703	893	1013	11											
		(3)	(3)	(3)	(3)	(3)	(3)	(3)	(3)	(3)	(3)	(3)	(3)	(3)	(3)	(3)	(3)	(3)	(3)	(3)	(3)	(3)	(3)												
		146	154	(3)	222	234	333	403	368	610	643	320	317	373	469	506	704	736	866	1129	1455	11													
		(3)	(3)	(3)	(3)	(3)	(3)	(3)	(3)	(3)	(3)	(3)	(3)	(3)	(3)	(3)	(3)	(3)	(3)	(3)	(3)	(3)	(3)												
Water pressure drop	Cooling	Low	kPa	6	8	7	8	5 (1)		7	4	5 (1)		8	7 (1)		8	6	4	5	7	5	6												
				(1)	(1)	(1)	(1)	(1)	(1)	(1)	(1)	(1)	(1)	(1)	(1)	(1)	(1)	(1)	(1)	(1)	(1)	(1)	(1)												
				8	11	10	12	8	7	10	7	8	10	11	9	10	12	9	7	8	10	9	13												
	(1)	(1)	(1)	(1)	(1)	(1)	(1)	(1)	(1)	(1)	(1)	(1)	(1)	(1)	(1)	(1)	(1)	(1)	(1)	(1)	(1)														
	12	14	13	16	11	12	14	12 (1)		16	14	13 (1)		16	13	12 (1)		14	12	20															
	(1)	(1)	(1)	(1)	(1)	(1)	(1)	(1)	(1)	(1)	(1)	(1)	(1)	(1)	(1)	(1)	(1)	(1)	(1)	(1)															
Heating	Low	kPa	3	4 (3)		2 (3)		8	5	8	14 (3)		9	8	6	8	5 (2)		4	7	4	6													
			(3)	(3)	(3)	(3)	(3)	(3)	(3)	(3)	(3)	(3)	(3)	(3)	(3)	(3)	(3)	(3)	(3)	(3)	(3)														
			4	5 (3)		3 (3)		10	6	12	19	22	12	11	9	12	8 (2)		6	10	7	12													
(3)	(3)	(3)	(3)	(3)	(3)	(3)	(3)	(3)	(3)	(3)	(3)	(3)	(3)	(3)	(3)	(3)	(3)	(3)	(3)	(3)															
High	kPa	4	7	6	3	4	14	8	16	24	29	14	15	12	17	11	13	10	14	10	18														
		(3)	(3)	(3)	(3)	(3)	(3)	(3)	(3)	(3)	(3)	(3)	(3)	(3)	(3)	(3)	(3)	(3)	(3)	(3)	(3)														

2 Specifications

2-1 Technical Specifications				FW M0 1D AF	FW M1 5D AF	FW M0 2D AF	FW M2 5D AF	FW M0 3D AF	FW M0 4D AF	FW M0 6D AF	FW M0 5D AF	FW M3 8D AF	FW M0 0D AF	FW M1 5D AT	FW M0 1D AT	FW M0 2D AT	FW M2 5D AT	FW M0 3D AT	FW M3 5D AT	FW M0 4D AT	FW M0 6D AT	FW M0 8D AT	FW M1 0D AT	
Fan	Type	Centrifugal																						
	Quantity	1			2						1			2										
	Air flow rate	Low	m³/h	17 4	205	23 8	23 7	35 6	46 0	31 6	56 5	63 6	21 1	17 8	21 1	241	32 0	36 1	47 0	57 0	64 2			
		Medium	m³/h	22 5	261	33 4	33 2	49 0	59 3	44 4	76 5	1, 00 7	27 1	23 3	27 1	341	45 0	49 7	60 5	77 1	1, 02 2			
High		m³/h	30 7	33 0	32 7	43 2	43 1	69 0	76 3	62 8	99 8	1, 36 2	34 4	31 9	34 4	442	64 0	70 6	78 5	1, 01 1	1, 39 3			
Air filter	Type	Polypropylene net																						
Total sound power level	Low	dBA	33 (4)	40 (4)	38 (4)	34 (4)	33 (4)	39 (4)	48 (4)	36 (4)	46 (4)	48 (4)	38 (4)	37 (4)	40 (4)	35 (4)	36 (4)	35 (4)	43 (4)	47 (4)	49 (4)			
	Medium	dBA	39 (4)	44 (4)	43 (4)	41 (4)	46 (4)	53 (4)	45 (4)	54 (4)	58 (4)	44 (4)	42 (4)	44 (4)	43 (4)	42 (4)	43 (4)	49 (4)	54 (4)	60 (4)				
	High	dBA	45 (4)	49 (4)	50 (4)	48 (4)	47 (4)	56 (4)	58 (4)	53 (4)	60 (4)	66 (4)	49 (4)	47 (4)	50 (4)	48 (4)	52 (4)	53 (4)	56 (4)	61 (4)	67 (4)			
Sound pressure level	Low	dBA	28 (5)	33 (5)	29 (5)	28 (5)	32 (5)	43 (5)	29 (5)	41 (5)	43 (5)	33 (5)	32 (5)	35 (5)	30 (5)	31 (5)	30 (5)	38 (5)	42 (5)	44 (5)				
	Medium	dBA	34 (5)	39 (5)	38 (5)	36 (5)	41 (5)	48 (5)	38 (5)	49 (5)	53 (5)	39 (5)	37 (5)	39 (5)	38 (5)	37 (5)	38 (5)	44 (5)	49 (5)	55 (5)				
	High	dBA	40 (5)	44 (5)	45 (5)	43 (5)	42 (5)	51 (5)	54 (5)	46 (5)	55 (5)	61 (5)	44 (5)	42 (5)	45 (5)	43 (5)	47 (5)	48 (5)	51 (5)	56 (5)	62 (5)			
Piping connections	Drain	OD	mm 16																					
Insulation material	Closed cells polyethylene																							
Water connections	Primary coil	inch	1/2"						3/4"			1/2"						3/4"						
	Additional coil	inch	1/2"						-			1/2"						-						
Allowed water temperature	Cooling	Min.	°C 5																					
		Max.	°C 95.0																					
	Heating	Min.	°C 5.00																					
		Max.	°C 95.000																					
Water content	Primary coil	dm³	0.46	0.70	0.71	1.06	1.42	1.43	0.95	2.15	0.46	0.70	0.71	1.06	0.95	1.42	1.43	2.15						
	Additional coil	dm³	0.18			0.29			0.40			0.53			-									

2-2 Electrical Specifications				FW M0 1D AF	FW M1 5D AF	FW M0 2D AF	FW M2 5D AF	FW M0 3D AF	FW M0 4D AF	FW M0 6D AF	FW M0 5D AF	FW M3 8D AF	FW M0 0D AF	FW M1 5D AT	FW M0 1D AT	FW M0 2D AT	FW M2 5D AT	FW M0 3D AT	FW M3 5D AT	FW M0 4D AT	FW M0 6D AT	FW M0 8D AT	FW M1 0D AT
Electric heater	Type	230 / 1 / 50																					
	Phase	1																					
	Frequency	Hz	50																				
	Voltage	V	230																				
	Power input	kW	1.0	1.5	1.6	2.0	3.0	1.5	1.0	1.5	1.6	2.0	3.0										
	Current	A	4.5	6.8	7.3	9.1	13.6	6.8	4.5	6.8	7.3	9.1	13.6										
Power supply	Type	230 / 1 / 50						-			230 / 1 / 50												
	Phase	1~						-			1~												
	Frequency	Hz	50						-			50											
	Voltage	V	230						-			230											

2 Specifications

2

2-2 Electrical Specifications			FW M0 1D AF	FW M1 5D AF	FW M0 2D AF	FW M2 5D AF	FW M0 3D AF	FW M0 4D AF	FW M0 6D AF	FW M3 5D AF	FW M0 8D AF	FW M1 0D AF	FW M1 5D AT	FW M0 1D AT	FW M0 2D AT	FW M2 5D AT	FW M0 3D AT	FW M3 5D AT	FW M0 4D AT	FW M0 6D AT	FW M0 8D AT	FW M1 0D AT
Current input	Low	A	0.09	0.11	0.14	0.19			0.39	0.54	0.11	0.09	0.11	0.14		0.19			0.39	0.54		
	Medium	A	0.11	0.14	0.20	0.29	0.28	0.29	0.57	0.78	0.14	0.11	0.14	0.20		0.29		0.28	0.57	0.78		
	High	A	0.16	0.20	0.27	0.40	0.39	0.40	0.80	1.07	0.20	0.16	0.20	0.27		0.40		0.39	0.80	1.07		
Required wire section		mm ²	0.5																			
Maximum absorbed current		A	0.170	0.240	0.250	0.440			0.800	1.120	0.240	0.170	0.240	0.250		0.440			0.800	1.120		

Notes

- (1) Cooling: indoor temp. 27°CDB, 19°CWB; entering water temp. 7°C, water temperature rise 5K.
 - (2) Heating: indoor temp. 20°CDB, 15°CWB; entering water temp. 45°C, water temperature drop 5K.
 - (3) Heating: indoor temp. 20°CDB, 15°CWB; entering water temp. 65°C, water temperature drop 10K.
 - (4) Sound power level according to ISO3741
 - (5) The sound pressure level is measured via a microphone at 1m distance of the unit.
- SL: The silent fan level of the air flow rate setting

3 Options

3 - 1 Options

FWW-DAT/DAF
FWL-DAT/DAF
FWM-DAT/DAF

Capacity and absorption of electric heater

Unit	Electric heater	Power input electric heater		Current Absorption	
		kW	A		
FW01	EEH01B6	1.0	4.34		
FW15	EEH02B6	1.5	6.52		
FW02	EEH02B6	1.5	6.52		
FW25	EEH03B6	1.6	6.95		
FW03	EEH03B6	1.6	6.95		
FW35	EEH06B6	2.0	8.69		
FW04	EEH06B6	2.0	8.69		
FW06	EEH06B6	2.0	8.69		
FW08	EEH10B6	3.0	13.00		
FW10	EEH10B6	3.0	13.00		

Power supply = 230 V +/- 10% / 1~ / 50Hz

4TW60011-3A











FWW-DAT/DAF
FWL-DAT/DAF
FWM-DAT/DAF

Description	Daikin	F2	F3	F4	F5	F6	F7	F8	F9	F10	F11	FWV	FWL	FWM	Notes/remarks
FCU unit	FWW+FWL+FWM	1	15	2	25	3	35	4	6	8	10				
Additional single row heat exchanger	ESRH..A6	ESRH02A6		ESRH03A6		ESRH06A6		ESRH10A6		X	X	X			Can not be used in combination with electric heater
Electric heater	EEH..A6	EEH01A6	EEH02A6	EEH03A6		EEH06A6		EEH10A6		X	X	X			Can not be used in combination with additional H/E requires electronic controller
2-pipe 230V ON-OFF 3 way motor driven valve complete with mounting kit	E2MV..A6	E2MV03A6			E2MV06A6		E2MV10A6		X	X	X				Requires electronic controller or electromechanical controller
4-pipe 230V ON-OFF 3 way motor driven valve complete with mounting kit	E4MV..A6	E4MV03A6			E4MV06A6		E4MV10A6		X	X	X				Requires electronic controller
2-pipe 230V ON-OFF 3 way motor driven valve complete with simplified mounting kit	E2MVD..A6	E2MVD03A6			E2MVD06A6		E2MVD10A6		X	X	X				Requires electronic controller or electromechanical controller
4-pipe 230V ON-OFF 3 way motor driven valve complete with simplified mounting kit	E4MVD..A6	E4MVD03A6			E4MVD06A6		E4MVD10A6		X	X	X				Requires electronic controller
2-pipe 24V ON-OFF 3 way motor driven valve complete with mounting kit	E2M2V..A6	E2M2V03A6			E2M2V06A6		E2M2V10A6		X	X	X				Independent power supply is necessary as fan coil units have not any 230V-24V transformer
4-pipe 24V ON-OFF 3 way motor driven valve complete with mounting kit	E4M2V..A6	E4M2V03A6			E4M2V06A6		E4M2V10A6		X	X	X				Independent power supply is necessary as fan coil units have not any 230V-24V transformer
2-pipe proportional 3 way motor driven valve complete with mounting kit	E2MPV..A6	E2MPV03A6			E2MPV06A6		E2MPV10A6		X	X	X				Requires electronic controller FWEC3A
4-pipe proportional 3 way motor driven valve complete with mounting kit	E4MPV..A6	E4MPV03A6			E4MPV06A6		E4MPV10A6		X	X	X				Requires electronic controller FWEC3A
230V ON-OFF 2 way motor driven valve complete with mounting kit (cooling h/e)	E2MV2..A6	E2MV207A6			E2MV210A6		X	X	X						Requires electronic controller or electromechanical controller
230V ON-OFF 2 way motor driven valve complete with mounting kit (additional h/e)	E2MV2..A6	E2MV207A6			E2MV210A6		X	X	X						Requires electronic controller
24V ON-OFF 2 way motor driven valve complete with mounting kit (cooling h/e)	E2M2V2..A6	E2M2V207A6			E2M2V210A6		X	X	X						Independent power supply is necessary as fan coil units have not any 230V-24V transformer
24V ON-OFF 2 way motor driven valve complete with mounting kit (additional h/e)	E2M2V2..A6	E2M2V207A6			E2M2V210A6		X	X	X						Independent power supply is necessary as fan coil units have not any 230V-24V transformer
Proportional 2 way motor driven valve complete with mounting kit (cooling h/e)	E2MPV2..A6	E2MPV207A6			E2MPV210A6		X	X	X						Requires electronic controller FWEC3A
Proportional 2 way motor driven valve complete with mounting kit (additional h/e)	E2MPV2..A6	E2MPV207A6			E2MPV210A6		X	X	X						Requires electronic controller FWEC3A
Fan stop thermostat	YFSTA6	YFSTA6			YFSTA6		X	X	X						
Air intake & discharge grill + front Filter fixing kit for concealed models	EAIDAF..A6	EAIDF02A6	EAIDF03A6	EAIDF06A6		EAIDF10A6		X	X	X					
Supporting feet feet (=supporting brackets + covers)	ESFV..A6	ESFV06A6			ESFV10A6		X	X	X						Covers can not be used for FWM
Supporting feet + grill	ESFVG..A6	ESFVG02A6	ESFVG03A6	ESFVG06A6		ESFVG10A6		X	X	X					
Fresh air intake louvers (manual)	EFA..A6	EFA02A6	EFA3A6	EFA6A6		EFA10A6		X	X	X					
Rear panel for vertical mounted models	ERP..A6	ERPV2A6	ERPV03A6	ERPV06A6		ERPV10A6		X	X	X					Only for vertical mounted units
Plenum box with circular connections	EPCC..A6	EPCC02A6	EPCC03A6	EPCC06A6		EPCC10A6		X	X	X					
Controller Electro mechanical built in	ECFWMB6	ECFWMB6			ECFWMB6		X	X	X						
Power interface for connection of up to 4 FCU to a single control panel	EPIMSB6	EPIMSB6			EPIMSB6		X	X	X						
Vertical Drain Pan	EDPVA6	EDPVA6			EDPVA6		X	X	X						
Horizontal Drain Pan	EDPHA6	EDPHA6			EDPHA6		X	X	X						
Fcu controller - Standard version	FWEC1AA	FWEC1A			FWEC1A		X	X	X						water probe included
Fcu controller - Advanced version	FWEC2AA	FWEC2A			FWEC2A		X	X	X						water probe included
Fcu controller - Advanced plus version	FWEC3AA	FWEC3A			FWEC3A		X	X	X						water probe included
Fcu temperature sensor kit	FWTSKAA	FWTSKA			FWTSKA		X	X	X						
Fcu relative humidity sensor kit	FWHSKAA	FWHSKA			FWHSKA		X	X	X						
On board fcu controller installation kit	FWECKAA	FWECKA			FWECKA		X	X	X						

4TW60019-2C(1)

4 Control systems

4 - 1 Control Systems

	Cool/heat changeover			Options		Basic control functions		Control features		
										
2-pipe	✓					✓	✓	✓	✓	
	✓			✓		✓	✓		✓	
	✓				✓	✓	✓	✓	✓	
	✓			✓	✓	✓	✓		✓	
		✓				✓	✓	✓		
		✓		✓		✓	✓			
			✓	✓	✓	✓	✓	✓	✓	✓
4-pipe	✓			✓		✓	✓		✓	
	✓					✓	✓	✓	✓	
			✓			✓	✓	✓		✓
			✓	✓		✓	✓		✓	✓



Manual cool/heat changeover.



Automatic cool/heat changeover based on water temperature.



Automatic cool/heat changeover based on air temperature.



Control of the 3-way/4pipe ON/OFF valve. The water valve shut-off once the desired temperature is reached.



The controller controls the electric heater as integration or replacement of the hot water heating system. When the operating mode selector switch is turned on "electric heater" and the electric heater is turned on, the fan runs continuously at medium speed.



The fan speed can be set at one of the 3 speeds (low, medium or maximum) by turning the operation mode selector.



The fan speed is switched automatically based on the difference between the temperature set on the thermostat and the room temperature.



Optimised comfort cooling. When the fan coil has reached the desired setpoint, the fan will operate at medium speed and at regular intervals to ensure constant room temperature and lower sound.



The controller prevents the fan coil unit from operating in one mode, if the required water temperature is not achieved to operate in the selected mode.



The dead zone is a temperature interval close to the set temperature. When the air is warmer/cooler than the top/lower limit of the neutral zone, the cooling/heating mode is selected.

5 Capacity tables

5 - 1 Cooling Capacity Tables - 2-pipe

5

FWV-DAT FWL-DAT FWM-DAT		22 16															
Air Temperature (°C DB - °C WB)		6 - 11				7 - 12				8 - 13				9 - 14			
Water Temperature (Entering °C - leaving °C)		Total cooling cap	Sensible cooling cap	Water flow	Water pressure drop	Total cooling cap	Sensible cooling cap	Water flow	Water pressure drop	Total cooling cap	Sensible cooling cap	Water flow	Water pressure drop	Total cooling cap	Sensible cooling cap	Water flow	Water pressure drop
Model		W	W	l/h	kPa	W	W	l/h	kPa	W	W	l/h	kPa	W	W	l/h	kPa
FW 01 T	Max	880	840	152	5	820	940	140	4	730	910	125	4	650	880	111	3
	Med	720	740	124	4	660	710	114	3	610	690	104	3	550	670	95	2
	Min	640	570	110	3	580	570	100	2	540	560	92	2	490	540	84	2
FW 15 T	Max	1020	910	174	6	920	1030	158	5	830	990	142	4	730	950	125	3
	Med	880	790	152	4	800	840	138	4	720	810	123	3	640	780	110	2
	Min	720	660	123	3	670	670	115	3	620	650	106	2	560	630	96	2
FW 02 T	Max	1200	1000	205	5	1030	1070	176	4	920	1030	158	3	830	1000	143	3
	Med	1040	880	178	4	840	800	145	3	820	850	141	3	750	820	129	2
	Min	870	720	150	3	750	670	128	2	690	680	119	2	640	660	109	2
FW 25 T	Max	1450	1340	249	7	1240	1340	212	5	1110	1290	190	4	970	1240	166	3
	Med	1190	1100	204	5	1020	1060	176	4	940	1030	161	3	860	1000	147	3
	Min	970	830	166	3	840	780	144	3	790	780	136	2	730	750	125	2
FW 03 T	Max	1730	1470	296	5	1480	1440	255	3	1370	1400	235	3	1260	1350	216	3
	Med	1450	1200	249	3	1260	1120	216	3	1180	1130	203	2	1080	1090	186	2
	Min	1240	960	213	3	1090	890	186	2	920	820	158	1	860	810	149	1
FW 35 T	Max	1960	2010	336	4	1750	1930	301	4	1550	1850	266	3	1420	1800	243	2
	Med	1490	1410	256	3	1400	1420	240	2	1290	1380	222	2	1180	1340	203	2
	Min	1320	1070	226	2	1140	1000	196	2	1070	1040	184	2	980	1010	169	1
FW 04 T	Max	2480	2170	425	5	2140	2210	368	4	1970	2140	339	3	1810	2080	310	3
	Med	1990	1740	341	3	1720	1630	295	2	1620	1600	279	2	1490	1550	256	2
	Min	1750	1360	300	3	1520	1270	261	2	1290	1170	221	1	1230	1190	212	1
FW 06 T	Max	2820	2570	484	6	2390	2460	410	4	2120	2350	363	3	1930	2280	331	3
	Med	2150	1990	369	4	1980	1950	340	3	1830	1890	314	3	1670	1830	287	2
	Min	1960	1650	336	3	1700	1550	292	2	1590	1540	272	2	1460	1480	250	2
FW 08 T	Max	3850	3380	661	5	3290	3260	565	4	3040	3160	522	3	2780	3060	478	3
	Med	3140	2680	539	3	2720	2510	467	3	2570	2510	441	2	2360	2420	405	2
	Min	2730	2130	469	3	2380	1990	409	2	2010	1840	346	1	1940	1870	333	1
FW 10 T	Max	4790	4200	822	8	4000	4270	687	6	3550	4100	610	5	3120	3930	536	4
	Med	3380	3120	579	4	3130	3210	538	4	2890	3120	496	3	2650	3020	455	3
	Min	2770	2270	474	3	2400	2120	412	2	2170	2100	373	2	1990	2030	342	2

4TW60012-1B(1/13)

5 Capacity tables

5 - 1 Cooling Capacity Tables - 2-pipe

FWV-DAT FWL-DAT FWM-DAT		25 18															
Air Temperature (°C DB - °C WB)		6 - 11				7 - 12				8 - 13				9 - 14			
Water Temperature (Entering °C - leaving °C)		Total cooling cap	Sensible cooling cap	Water flow	Water pressure drop	Total cooling cap	Sensible cooling cap	Water flow	Water pressure drop	Total cooling cap	Sensible cooling cap	Water flow	Water pressure drop	Total cooling cap	Sensible cooling cap	Water flow	Water pressure drop
Model		W	W	l/h	kPa	W	W	l/h	kPa	W	W	l/h	kPa	W	W	l/h	kPa
FW 01 T	Max	1480	1110	254	13	1260	1030	217	9	1020	940	175	6	920	1050	158	5
	Med	1190	900	205	9	1010	830	174	6	810	750	139	4	740	790	126	4
	Min	1000	740	172	6	850	670	145	5	680	610	117	3	620	630	107	3
FW 15 T	Max	1680	1210	287	14	1430	1110	245	10	1160	1010	200	7	1040	1150	178	6
	Med	1460	1060	251	11	1250	980	215	8	1020	890	174	6	900	930	155	4
	Min	1210	890	208	8	1040	810	178	6	840	740	144	4	740	740	128	3
FW 02 T	Max	1890	1320	325	11	1640	1220	281	9	1360	1110	233	6	1140	1180	196	5
	Med	1640	1160	282	9	1420	1070	244	7	1180	970	202	5	980	960	169	4
	Min	1310	930	225	6	1130	860	194	5	930	780	160	3	780	720	134	2
FW 25 T	Max	2330	1750	400	15	2010	1620	346	12	1660	1490	286	8	1390	1490	238	6
	Med	1960	1460	336	11	1690	1350	289	9	1380	1240	237	6	1160	1180	199	4
	Min	1540	1100	264	7	1320	1010	227	6	1060	910	182	4	920	870	157	3
FW 03 T	Max	2820	1970	484	11	2440	1820	419	8	2010	1640	345	6	1660	1590	284	4
	Med	2290	1590	393	7	1970	1460	338	6	1590	1310	273	4	1320	1200	226	3
	Min	1690	1180	290	4	1460	1080	251	3	1300	1020	224	3	1140	950	196	2
FW 35 T	Max	3370	2550	578	11	2870	2350	492	9	2290	2130	392	6	2010	2160	346	5
	Med	2520	1890	432	7	2100	1730	361	5	1630	1600	280	3	1500	1550	257	3
	Min	1880	1340	322	4	1560	1210	267	3	1380	1140	237	2	1200	1070	205	2
FW 04 T	Max	4170	2940	715	12	3590	2710	617	9	2940	2450	504	6	2440	2460	418	4
	Med	3140	2280	538	7	2670	2090	458	5	2080	1860	357	3	1880	1800	322	3
	Min	2390	1670	410	4	2060	1540	354	3	1830	1440	315	3	1600	1350	274	2
FW 06 T	Max	4600	3400	788	14	3970	3150	682	10	3280	2880	562	7	2690	2740	463	5
	Med	3720	2720	639	9	3200	2510	549	7	2580	2270	443	5	2160	2140	371	4
	Min	3040	2160	522	7	2580	1970	444	5	2050	1760	352	3	1780	1660	306	3
FW 08 T	Max	6470	4590	1109	11	5590	4230	960	9	4590	3830	788	6	3730	3620	640	4
	Med	5060	3580	868	7	4320	3270	741	6	3360	2890	578	4	2850	2690	489	3
	Min	3780	2640	649	4	3230	2410	554	3	2870	2270	492	3	2500	2120	429	2
FW 10 T	Max	7730	5560	1325	19	6690	5150	1148	15	5540	4700	951	10	4520	4760	776	7
	Med	6000	4320	1030	12	5150	3980	885	9	4160	3590	714	6	3460	3540	595	5
	Min	3920	2830	672	6	3270	2570	561	4	2900	2420	498	3	2520	2280	433	3

4TW60012-1B(3/13)

5 Capacity tables

5 - 1 Cooling Capacity Tables - 2-pipe

5

FWV-DAT FWL-DAT FWM-DAT		27 19															
Air Temperature (°C DB - °C WB)		6 - 11				7 - 12				8 - 13				9 - 14			
Water Temperature (Entering °C - leaving °C)		Total cooling cap	Sensible cooling cap	Water flow	Water pressure drop	Total cooling cap	Sensible cooling cap	Water flow	Water pressure drop	Total cooling cap	Sensible cooling cap	Water flow	Water pressure drop	Total cooling cap	Sensible cooling cap	Water flow	Water pressure drop
Model		W	W	l/h	kPa	W	W	l/h	kPa	W	W	l/h	kPa	W	W	l/h	kPa
FW 01 T	Max	1750	1280	301	17	1540	1200	264	13	1310	1120	226	10	1090	1200	188	7
	Med	1410	1040	242	12	1240	970	213	9	1060	900	181	7	880	900	151	5
	Min	1180	850	203	9	1040	790	179	7	890	730	152	5	710	670	122	3
FW 15 T	Max	1980	1390	339	18	1740	1300	298	14	1490	1210	256	11	1210	1110	209	8
	Med	1720	1220	296	14	1520	1140	261	11	1300	1060	223	9	1060	970	182	6
	Min	1430	1020	245	10	1260	950	216	8	1080	880	185	6	880	800	151	4
FW 02 T	Max	2210	1510	379	15	1960	1420	337	12	1700	1320	292	9	1410	1210	242	7
	Med	1910	1330	328	12	1700	1240	292	9	1480	1150	253	7	1230	1060	211	5
	Min	1530	1070	263	8	1360	1000	234	6	1180	930	202	5	970	850	167	3
FW 25 T	Max	2720	2000	467	20	2420	1880	415	16	2100	1760	360	13	1740	1620	299	9
	Med	2290	1670	392	15	2030	1570	348	12	1760	1460	301	9	1450	1350	249	7
	Min	1800	1260	309	10	1600	1180	275	8	1380	1090	237	6	1120	990	193	4
FW 03 T	Max	3290	2260	564	14	2930	2110	503	11	2540	1950	436	9	2110	1790	362	6
	Med	2670	1820	459	10	2380	1700	408	8	2060	1570	353	6	1680	1420	289	4
	Min	1990	1360	341	6	1760	1260	302	5	1500	1150	258	4	1320	1080	227	3
FW 35 T	Max	3980	2930	682	15	3510	2750	602	12	3000	2560	515	9	2410	2490	414	6
	Med	3000	2190	514	9	2630	2040	451	7	2220	1880	381	5	1800	1790	309	4
	Min	2280	1570	391	6	1980	1450	340	4	1610	1310	277	3	1400	1230	240	2
FW 04 T	Max	4870	3370	835	15	4330	3150	743	12	3750	2920	643	10	3090	2670	530	7
	Med	3690	2620	632	9	3270	2450	561	8	2800	2260	481	6	2230	2050	383	4
	Min	2850	1950	489	6	2510	1800	431	5	2100	1640	361	3	1860	1540	319	3
FW 06 T	Max	5360	3890	919	18	4770	3650	818	14	4140	3400	710	11	3430	3140	589	8
	Med	4350	3120	747	12	3870	2920	664	10	3340	2710	574	8	2730	2480	469	5
	Min	3570	2490	613	9	3170	2320	544	7	2710	2140	466	5	2150	1920	370	4
FW 08 T	Max	7520	5250	1289	15	6710	4910	1152	12	5830	4560	1001	9	4830	4170	829	7
	Med	5930	4110	1016	10	5270	3830	904	8	4530	3530	778	6	3630	3190	624	4
	Min	4510	3070	774	6	3970	2840	681	5	3310	2570	569	4	2910	2420	500	3
FW 10 T	Max	9000	6350	1544	25	8020	5960	1376	20	6960	5560	1196	16	5800	5120	995	11
	Med	7020	4950	1204	16	6240	4630	1071	13	5390	4300	924	10	4400	3930	756	7
	Min	4690	3290	804	8	4110	3050	706	6	3430	2780	588	5	2940	2600	505	3

4TW60012-1B(5/13)

5 Capacity tables

5 - 1 Cooling Capacity Tables - 2-pipe

FWV-DAT FWL-DAT FWM-DAT		30-22															
Air Temperature (°C DB - °C WB)		6 - 11				7 - 12				8 - 13				9 - 14			
Water Temperature (Entering °C - leaving °C)		Total cooling cap	Sensible cooling cap	Water flow	Water pressure drop	Total cooling cap	Sensible cooling cap	Water flow	Water pressure drop	Total cooling cap	Sensible cooling cap	Water flow	Water pressure drop	Total cooling cap	Sensible cooling cap	Water flow	Water pressure drop
Model		W	W	l/h	kPa	W	W	l/h	kPa	W	W	l/h	kPa	W	W	l/h	kPa
FW 01 T	Max	2640	1520	453	35	2440	1450	419	30	2240	1370	384	26	2020	1290	347	21
	Med	2120	1230	364	24	1960	1170	337	21	1800	1110	309	18	1630	1050	279	15
	Min	1770	1020	304	17	1640	960	282	15	1510	910	259	13	1360	860	234	11
FW 15 T	Max	2960	1660	508	37	2740	1580	471	32	2510	1490	432	27	2270	1410	390	23
	Med	2570	1460	441	29	2380	1380	409	25	2190	1310	375	21	1980	1230	340	18
	Min	2130	1220	365	21	1970	1160	339	18	1810	1090	311	15	1640	1030	282	13
FW 02 T	Max	3250	1800	558	29	3020	1710	518	26	2780	1620	477	22	2530	1530	434	18
	Med	2800	1580	479	22	2600	1500	446	20	2400	1420	412	17	2190	1340	375	14
	Min	2240	1270	385	15	2090	1210	358	13	1930	1140	331	12	1750	1080	301	10
FW 25 T	Max	4000	2340	687	39	3720	2230	639	35	3430	2120	588	30	3120	2010	536	25
	Med	3350	1970	575	29	3120	1870	535	25	2870	1780	494	22	2620	1680	450	18
	Min	2630	1500	451	19	2450	1430	421	17	2260	1350	389	14	2070	1270	355	12
FW 03 T	Max	4770	2690	818	27	4450	2550	764	24	4110	2410	706	20	3760	2280	645	17
	Med	3880	2180	665	19	3620	2070	621	16	3350	1960	575	14	3060	1840	526	12
	Min	2890	1630	495	11	2700	1550	463	10	2500	1460	429	9	2290	1370	393	7
FW 35 T	Max	5930	3470	1016	31	5500	3300	944	27	5050	3130	868	23	4590	2960	787	19
	Med	4490	2610	770	19	4170	2480	715	16	3830	2350	658	14	3470	2220	597	12
	Min	3450	1920	591	12	3200	1820	549	10	2940	1720	505	9	2670	1610	458	7
FW 04 T	Max	7110	4000	1220	30	6630	3800	1137	26	6120	3600	1050	22	5580	3400	958	19
	Med	5400	3120	926	18	5030	2960	864	16	4650	2810	798	14	4240	2650	729	12
	Min	4190	2350	719	12	3910	2230	671	10	3620	2110	621	9	3300	1980	567	8
FW 06 T	Max	7810	4570	1340	34	7280	4350	1249	30	6720	4130	1153	26	6130	3910	1053	22
	Med	6350	3690	1090	24	5920	3510	1016	21	5470	3330	939	18	4990	3140	857	15
	Min	5220	2970	895	17	4870	2820	836	15	4500	2670	773	13	4110	2520	706	11
FW 08 T	Max	10880	6210	1867	29	10160	5900	1743	25	9400	5600	1613	22	8600	5280	1476	19
	Med	8610	4890	1478	19	8040	4650	1381	17	7440	4400	1278	15	6810	4150	1169	12
	Min	6630	3710	1137	12	6190	3520	1062	11	5730	3320	983	9	5230	3120	898	8
FW 10 T	Max	13100	7470	2246	48	12230	7120	2098	42	11280	6760	1937	36	10290	6390	1767	31
	Med	10270	5860	1762	31	9570	5580	1642	27	8840	5290	1517	24	8060	4990	1384	20
	Min	6950	3950	1193	16	6480	3750	1112	14	5980	3550	1026	12	5440	3340	935	10

4TW60012-1B(7/13)

5 Capacity tables

5 - 2 Cooling Capacity Tables - 4-pipe

5

FWV-DAF
FWL-DAF
FWM-DAF

Air Temperature (°C DB - °C WB)		22 16															
Water Temperature (Entering °C - leaving °C)		6 - 11				7 - 12				8 - 13				9 - 14			
Model		Total cooling cap	Sensible cooling cap	Water flow	Water pressure drop	Total cooling cap	Sensible cooling cap	Water flow	Water pressure drop	Total cooling cap	Sensible cooling cap	Water flow	Water pressure drop	Total cooling cap	Sensible cooling cap	Water flow	Water pressure drop
		W	W	l/h	kPa	W	W	l/h	kPa	W	W	l/h	kPa	W	W	l/h	kPa
FW 01 F	Max	850	930	146	5	770	900	132	4	690	870	118	3	620	840	107	3
	Med	670	640	116	3	620	680	107	3	570	660	98	2	520	640	90	2
	Min	620	550	107	3	560	560	96	2	520	540	89	2	470	520	81	2
FW 15 F	Max	990	880	170	5	900	990	154	5	800	960	138	4	710	920	121	3
	Med	860	770	148	4	780	810	134	4	700	780	120	3	630	760	108	2
	Min	710	650	122	3	660	660	114	3	610	640	104	2	550	620	95	2
FW 02 F	Max	1030	1040	177	5	940	1000	161	4	860	970	147	4	780	940	134	3
	Med	940	870	162	4	830	830	143	3	770	810	132	3	700	780	121	3
	Min	830	720	142	3	710	670	122	3	650	650	112	2	600	630	103	2
FW 25 F	Max	1430	1310	245	7	1220	1320	209	5	1090	1270	187	4	960	1220	164	3
	Med	1170	1080	200	5	1010	1040	173	4	930	1010	159	3	850	980	146	3
	Min	960	830	165	3	830	770	143	3	790	770	135	2	720	740	124	2
FW 03 F	Max	1680	1430	289	4	1460	1410	251	3	1350	1370	232	3	1240	1320	213	2
	Med	1440	1180	246	3	1250	1100	214	3	1160	1100	199	2	1070	1060	183	2
	Min	1230	950	211	3	1080	880	185	2	910	810	157	1	850	800	147	1
FW 35 F	Max	1930	1980	331	4	1730	1900	296	4	1540	1820	264	3	1410	1770	241	2
	Med	1480	1400	255	3	1390	1410	238	2	1280	1370	220	2	1170	1320	202	2
	Min	1310	1070	225	2	1140	990	195	2	1060	1030	183	1	980	1000	168	1
FW 04 F	Max	2420	2120	415	4	2110	2170	363	4	1950	2100	335	3	1790	2040	307	3
	Med	1980	1720	339	3	1710	1610	294	2	1610	1580	276	2	1480	1530	254	2
	Min	1740	1350	298	3	1510	1260	260	2	1280	1160	220	1	1220	1170	210	1
FW 06 F	Max	2750	2500	471	5	2330	2400	400	4	2070	2300	356	3	1900	2230	326	3
	Med	2140	1960	367	4	1960	1920	336	3	1810	1860	310	3	1660	1800	284	2
	Min	1940	1630	334	3	1690	1520	289	2	1570	1510	269	2	1440	1460	247	2
FW 08 F	Max	3790	3330	650	5	3270	3220	561	3	3020	3120	518	3	2760	3020	475	3
	Med	3130	2660	537	3	2710	2490	465	2	2560	2490	439	2	2350	2410	403	2
	Min	2720	2120	467	3	2370	1970	407	2	2010	1820	344	1	1930	1850	331	1
FW 10 F	Max	4690	4120	803	7	3930	4180	674	5	3480	4010	597	4	3090	3860	530	3
	Med	3360	3090	576	4	3110	3170	533	3	2870	3080	492	3	2630	2990	451	2
	Min	2750	2260	472	3	2390	2110	410	2	2160	2080	370	2	1980	2010	340	1

4TW60012-1B(2/13)

5 Capacity tables

5 - 2 Cooling Capacity Tables - 4-pipe

FWV-DAF FWL-DAF FWM-DAF		25 18															
Air Temperature (°C DB - °C WB)		6 - 11				7 - 12				8 - 13				9 - 14			
Water Temperature (Entering °C - leaving °C)		Total cooling cap	Sensible cooling cap	Water flow	Water pressure drop	Total cooling cap	Sensible cooling cap	Water flow	Water pressure drop	Total cooling cap	Sensible cooling cap	Water flow	Water pressure drop	Total cooling cap	Sensible cooling cap	Water flow	Water pressure drop
Model		W	W	l/h	kPa	W	W	l/h	kPa	W	W	l/h	kPa	W	W	l/h	kPa
FW 01 F	Max	1400	1060	241	11	1190	980	205	9	960	890	165	6	870	1000	149	5
	Med	1100	840	188	7	930	770	159	6	740	700	127	4	680	750	116	3
	Min	950	700	163	6	800	640	138	4	660	590	113	3	600	610	103	3
FW 15 F	Max	1630	1180	280	13	1390	1090	239	10	1130	990	194	7	1010	1110	173	5
	Med	1430	1030	245	10	1220	950	209	8	990	860	170	5	880	900	151	4
	Min	1190	870	204	7	1010	800	174	6	820	720	141	4	730	720	125	3
FW 02 F	Max	1730	1360	297	12	1490	1260	256	10	1230	1160	211	7	1050	1110	180	5
	Med	1500	1140	257	10	1290	1050	222	7	1060	970	183	5	900	910	155	4
	Min	1210	910	208	7	1040	840	179	5	870	770	150	4	760	730	130	3
FW 25 F	Max	2300	1720	394	15	1980	1600	340	11	1640	1460	281	8	1370	1460	235	6
	Med	1930	1440	331	11	1660	1330	285	8	1360	1210	234	6	1140	1160	196	4
	Min	1520	1090	261	7	1300	1000	224	6	1050	900	180	4	910	860	156	3
FW 03 F	Max	2770	1930	474	10	2390	1780	410	8	1970	1610	337	6	1620	1550	278	4
	Med	2240	1560	384	7	1930	1420	330	5	1550	1270	266	4	1300	1180	224	3
	Min	1660	1160	285	4	1450	1070	249	3	1290	1000	222	3	1130	940	194	2
FW 35 F	Max	3330	2510	570	11	2830	2320	485	8	2250	2100	386	6	1980	2120	341	4
	Med	2490	1870	428	7	2080	1710	357	5	1610	1580	277	3	1490	1530	256	3
	Min	1860	1330	319	4	1550	1210	266	3	1370	1140	236	2	1190	1070	205	2
FW 04 F	Max	4100	2890	703	11	3530	2660	606	9	2880	2410	494	6	2390	2410	411	4
	Med	3100	2250	532	7	2630	2060	452	5	2070	1840	355	3	1860	1770	320	3
	Min	2360	1650	405	4	2050	1520	351	3	1820	1430	313	3	1590	1340	273	2
FW 06 F	Max	4500	3320	772	13	3890	3080	668	10	3200	2810	550	7	2640	2660	453	5
	Med	3660	2670	628	9	3150	2460	540	7	2530	2220	435	5	2120	2100	365	3
	Min	2990	2120	513	6	2530	1940	435	5	2040	1740	350	3	1770	1640	303	2
FW 08 F	Max	6390	4540	1097	11	5530	4180	949	9	4530	3780	778	6	3680	3570	633	4
	Med	5020	3550	862	7	4290	3240	735	6	3330	2860	571	4	2840	2680	487	3
	Min	3740	2620	642	4	3210	2390	551	3	2860	2250	490	3	2490	2110	427	2
FW 10 F	Max	7590	5460	1301	15	6570	5050	1128	12	5430	4610	932	8	4430	4660	761	6
	Med	5930	4260	1016	10	5090	3930	873	7	4090	3540	702	5	3420	3490	587	4
	Min	3880	2800	665	5	3260	2550	559	3	2890	2410	496	3	2510	2260	431	2

4TW60012-1B(4/13)

5 Capacity tables

5 - 2 Cooling Capacity Tables - 4-pipe

5

FWV-DAF FWL-DAF FWM-DAF		27-19															
Air Temperature (°C DB - °C WB)		6 - 11				7 - 12				8 - 13				9 - 14			
Water Temperature (Entering °C - leaving °C)		Total cooling cap	Sensible cooling cap	Water flow	Water pressure drop	Total cooling cap	Sensible cooling cap	Water flow	Water pressure drop	Total cooling cap	Sensible cooling cap	Water flow	Water pressure drop	Total cooling cap	Sensible cooling cap	Water flow	Water pressure drop
Model		W	W	l/h	kPa	W	W	l/h	kPa	W	W	l/h	kPa	W	W	l/h	kPa
FW 01 F	Max	1660	1220	285	15	1460	1140	250	12	1240	1060	213	9	1040	1150	178	7
	Med	1300	970	223	10	1140	900	196	8	970	840	166	6	810	860	139	4
	Min	1130	810	193	8	990	750	169	6	840	700	144	5	670	640	115	3
FW 15 F	Max	1920	1360	330	17	1690	1270	291	14	1450	1170	249	10	1180	1080	203	7
	Med	1680	1190	288	14	1480	1110	254	11	1270	1030	218	8	1040	940	178	6
	Min	1400	1000	240	10	1240	930	212	8	1060	860	182	6	860	790	147	4
FW 02 F	Max	2020	1550	347	16	1790	1460	308	13	1550	1370	266	10	1240	1270	212	7
	Med	1750	1300	301	13	1560	1220	267	10	1340	1140	231	8	1110	1050	191	6
	Min	1420	1040	244	9	1260	980	216	7	1080	910	186	5	890	830	153	4
FW 25 F	Max	2680	1970	460	20	2380	1850	409	16	2060	1730	354	12	1710	1600	294	9
	Med	2250	1650	386	14	2000	1540	343	12	1730	1440	297	9	1430	1320	245	6
	Min	1780	1250	305	10	1580	1170	272	8	1360	1080	234	6	1110	980	191	4
FW 03 F	Max	3220	2210	552	13	2870	2070	493	11	2490	1910	427	8	2060	1750	354	6
	Med	2610	1780	449	9	2330	1660	400	8	2010	1530	345	6	1640	1390	282	4
	Min	1960	1340	336	6	1730	1240	297	5	1470	1130	253	3	1310	1070	225	3
FW 35 F	Max	3920	2890	673	15	3460	2710	594	12	2960	2510	507	9	2380	2440	408	6
	Med	2970	2160	509	9	2600	2020	447	7	2190	1860	376	5	1780	1760	306	4
	Min	2260	1560	388	6	1960	1440	336	4	1590	1290	273	3	1390	1220	239	2
FW 04 F	Max	4780	3310	821	15	4260	3090	730	12	3680	2870	632	9	3030	2620	520	7
	Med	3640	2590	625	9	3230	2420	554	7	2760	2230	474	6	2200	2010	377	4
	Min	2820	1920	483	6	2480	1780	425	5	2080	1620	357	3	1850	1530	317	3
FW 06 F	Max	5250	3800	900	17	4670	3570	802	14	4050	3320	696	11	3360	3060	577	8
	Med	4280	3060	735	12	3810	2870	653	10	3290	2660	564	7	2680	2430	461	5
	Min	3510	2440	603	8	3110	2280	534	7	2660	2100	457	5	2100	1880	361	3
FW 08 F	Max	7430	5190	1275	15	6640	4850	1138	12	5760	4500	990	9	4770	4120	819	7
	Med	5880	4080	1010	10	5230	3800	898	8	4500	3510	772	6	3600	3160	618	4
	Min	4470	3050	767	6	3930	2820	675	5	3270	2550	562	3	2900	2400	497	3
FW 10 F	Max	8840	6240	1516	20	7880	5850	1352	16	6840	5450	1173	12	5690	5020	977	9
	Med	6930	4890	1190	13	6160	4570	1057	10	5320	4240	912	8	4340	3880	745	6
	Min	4650	3260	797	6	4070	3020	699	5	3390	2750	581	4	2930	2580	503	3

4TW60012-1B(6/13)

5 Capacity tables

5 - 2 Cooling Capacity Tables - 4-pipe

FWV-DAF FWL-DAF FWM-DAF		30 22															
Air Temperature (°C DB - °C WB)		6 - 11				7 - 12				8 - 13				9 - 14			
Water Temperature (Entering °C - leaving °C)		Total cooling cap	Sensible cooling cap	Water flow	Water pressure drop	Total cooling cap	Sensible cooling cap	Water flow	Water pressure drop	Total cooling cap	Sensible cooling cap	Water flow	Water pressure drop	Total cooling cap	Sensible cooling cap	Water flow	Water pressure drop
Model		W	W	l/h	kPa	W	W	l/h	kPa	W	W	l/h	kPa	W	W	l/h	kPa
FW 01 F	Max	2510	1440	430	32	2320	1370	398	27	2120	1300	364	23	1910	1230	329	19
	Med	1970	1150	337	21	1820	1090	312	18	1670	1030	286	15	1500	980	258	13
	Min	1690	970	290	16	1570	920	269	14	1440	870	246	12	1300	820	223	10
FW 15 F	Max	2880	1620	495	35	2670	1540	458	30	2450	1450	420	26	2210	1370	380	22
	Med	2500	1420	430	27	2320	1350	399	24	2130	1280	366	20	1930	1200	332	17
	Min	2080	1190	357	20	1930	1130	332	17	1780	1070	305	15	1610	1010	277	12
FW 02 F	Max	2990	1810	513	32	2780	1730	476	28	2550	1640	438	24	2320	1560	398	20
	Med	2580	1530	442	25	2400	1460	412	22	2210	1380	379	19	2010	1310	345	16
	Min	2090	1230	359	17	1950	1170	334	15	1790	1110	308	13	1630	1050	280	11
FW 25 F	Max	3940	2310	676	38	3670	2200	629	34	3380	2090	580	29	3070	1980	528	24
	Med	3300	1940	566	28	3070	1840	527	25	2830	1750	486	21	2580	1650	443	18
	Min	2600	1490	446	19	2420	1410	416	16	2240	1340	384	14	2040	1260	351	12
FW 03 F	Max	4670	2630	802	26	4360	2500	748	23	4030	2370	692	20	3680	2230	632	17
	Med	3790	2130	650	18	3540	2020	607	16	3280	1910	562	14	2990	1800	514	12
	Min	2840	1600	487	11	2660	1520	456	10	2460	1440	422	8	2250	1350	387	7
FW 35 F	Max	5840	3420	1002	30	5430	3260	931	26	4990	3090	856	22	4520	2920	777	19
	Med	4450	2580	762	18	4130	2460	708	16	3790	2330	651	14	3440	2190	591	12
	Min	3410	1910	586	12	3170	1800	544	10	2910	1700	501	9	2640	1590	453	7
FW 04 F	Max	6990	3930	1199	29	6510	3740	1117	25	6010	3540	1032	22	5480	3340	941	18
	Med	5330	3080	915	18	4970	2930	853	16	4590	2770	789	14	4190	2610	720	12
	Min	4140	2320	710	11	3860	2200	663	10	3570	2080	613	9	3260	1950	560	7
FW 06 F	Max	7650	4470	1312	33	7130	4260	1224	29	6580	4040	1130	25	6000	3820	1031	21
	Med	6250	3630	1073	23	5830	3450	1001	20	5380	3270	925	18	4920	3090	844	15
	Min	5130	2920	880	16	4790	2770	822	14	4430	2620	760	13	4040	2470	694	11
FW 08 F	Max	10760	6140	1846	28	10050	5840	1724	25	9290	5530	1596	21	8500	5220	1460	18
	Med	8550	4860	1467	19	7990	4620	1371	17	7390	4370	1269	14	6760	4120	1161	12
	Min	6580	3680	1127	12	6140	3490	1054	10	5680	3300	975	9	5180	3100	891	8
FW 10 F	Max	12880	7340	2208	38	12010	7000	2061	34	11090	6640	1904	29	10110	6280	1737	25
	Med	10140	5790	1740	25	9450	5510	1622	22	8730	5220	1498	19	7960	4930	1367	16
	Min	6900	3920	1183	13	6430	3720	1103	11	5930	3520	1018	10	5400	3310	927	8

4TW60012-1B(8/13)

5 Capacity tables

5 - 3 Heating Capacity Tables - 2-pipe

5

FWV-DAT FWL-DAT FWM-DAT													
Air Temperature (°C)		20											
Water Temperature (Entering °C - leaving °C)		45 - 40			60 - 50			70 - 60			90 - 70		
Model		Heating capacity	Water flow	Water pressure drop	Heating capacity	Water flow	Water pressure drop	Heating capacity	Water flow	Water pressure drop	Heating capacity	Water flow	Water pressure drop
		W	l/h	kPa	W	l/h	kPa	W	l/h	kPa	W	l/h	kPa
FW 01 T	Max	1820	317	15	2840	249	10	3710	325	15	4940	218	7
	Med	1480	256	11	2310	201	7	2990	263	10	4010	177	5
	Min	1210	211	8	1900	166	5	2470	216	7	3320	147	3
FW 15 T	Max	1840	320	14	2870	251	8	3740	329	13	4970	219	6
	Med	1720	300	12	2700	236	7	3500	307	11	4690	207	5
	Min	1450	252	9	2270	198	6	2930	257	8	3950	174	4
FW 02 T	Max	2150	373	12	3360	293	7	4350	382	11	5830	257	5
	Med	1810	315	9	2840	248	6	3670	322	8	4940	218	4
	Min	1500	260	6	2350	206	4	3040	267	6	4110	181	3
FW 25 T	Max	2700	469	17	4220	369	10	5470	480	16	7320	323	8
	Med	2260	393	12	3540	309	8	4570	401	12	6150	271	6
	Min	1740	302	8	2730	239	5	3520	308	7	4760	210	4
FW 03 T	Max	3200	556	11	5030	439	7	6460	567	11	8760	386	5
	Med	2580	449	8	4070	356	5	5220	458	7	7110	314	4
	Min	1910	332	5	3020	264	3	3860	339	4	5290	233	2
FW 35 T	Max	4050	704	13	6330	553	8	8210	720	13	11000	486	6
	Med	3130	545	8	4920	430	5	6340	556	8	8550	378	4
	Min	2390	415	5	3760	328	3	4830	424	5	6570	290	2
FW 04 T	Max	4240	736	10	6620	578	6	8570	752	10	11480	507	5
	Med	3240	563	6	5070	443	4	6570	576	6	8840	390	3
	Min	2470	430	4	3880	339	2	5030	441	4	6760	299	2
FW 06 T	Max	4980	865	13	7790	681	8	10080	884	12	13520	597	6
	Med	4080	709	9	6400	559	6	8250	724	9	11120	491	4
	Min	3310	576	6	5200	454	4	6700	588	6	9070	400	3
FW 08 T	Max	6490	1129	10	10170	889	6	13130	1152	9	17650	779	4
	Med	5170	898	7	8100	708	4	10460	918	6	14100	623	3
	Min	3970	690	4	6230	544	3	8060	707	4	10880	480	2
FW 10 T	Max	8400	1460	19	13130	1147	11	17000	1492	18	22760	1005	8
	Med	6530	1135	12	10220	893	7	13200	1158	11	17740	783	5
	Min	4390	764	6	6890	602	4	8910	782	6	12020	531	3

4TW60012-1B(9/13)

5 Capacity tables

5 - 3 Heating Capacity Tables - 2-pipe

FWV-DAT FWL-DAT FWM-DAT													
Air Temperature (°C)		22											
Water Temperature (Entering °C - leaving °C)		45 40			60 50			70 60			90 70		
Model		Heating capacity	Water flow	Water pressure drop	Heating capacity	Water flow	Water pressure drop	Heating capacity	Water flow	Water pressure drop	Heating capacity	Water flow	Water pressure drop
		W	l/h	kPa	W	l/h	kPa	W	l/h	kPa	W	l/h	kPa
FW 01 T	Max	1650	287	13	2670	233	8	3530	310	13	4750	210	7
	Med	1330	232	9	2160	189	6	2850	250	9	3860	170	5
	Min	1100	191	6	1780	156	4	2350	206	7	3190	141	3
FW 15 T	Max	1670	290	11	2690	235	7	3560	313	12	4790	211	6
	Med	1560	272	10	2530	221	7	3330	292	11	4510	199	5
	Min	1310	228	7	2130	186	5	2790	245	8	3800	168	4
FW 02 T	Max	1950	338	10	3150	275	7	4140	363	10	5610	248	5
	Med	1640	285	7	2660	233	5	3500	307	8	4760	210	4
	Min	1360	236	5	2210	193	4	2890	254	6	3950	174	3
FW 25 T	Max	2450	425	14	3960	346	9	5210	457	15	7050	311	7
	Med	2050	356	10	3320	290	7	4350	381	11	5920	261	5
	Min	1580	274	7	2560	224	4	3350	294	7	4590	203	3
FW 03 T	Max	2900	505	9	4730	413	6	6150	540	10	8430	372	5
	Med	2340	407	7	3820	334	4	4970	436	7	6840	302	3
	Min	1730	302	4	2840	248	3	3670	322	4	5090	225	2
FW 35 T	Max	3670	638	11	5940	519	7	7820	686	12	10590	467	6
	Med	2840	494	7	4620	403	5	6040	529	7	8240	364	4
	Min	2160	376	4	3520	308	3	4600	404	5	6330	279	2
FW 04 T	Max	3840	668	9	6210	543	6	8160	716	9	11050	488	4
	Med	2930	510	5	4750	415	4	6250	548	6	8500	376	3
	Min	2240	389	3	3630	318	2	4780	420	3	6510	287	2
FW 06 T	Max	4510	785	11	7310	639	7	9590	841	11	13020	575	6
	Med	3700	643	8	6010	525	5	7850	689	8	10710	473	4
	Min	3000	521	5	4880	426	4	6380	560	6	8730	386	3
FW 08 T	Max	5890	1024	8	9550	834	5	12500	1097	9	17000	750	4
	Med	4680	813	6	7600	664	4	9960	874	6	13580	600	3
	Min	3590	625	3	5840	510	2	7670	673	4	10460	462	2
FW 10 T	Max	7610	1323	16	12320	1077	10	16190	1420	16	21920	968	8
	Med	5920	1029	10	9600	839	7	12570	1102	10	17080	754	5
	Min	3980	692	5	6460	565	3	8490	744	5	11570	511	3

4TW60012-1B(10/13)

5 Capacity tables

5 - 3 Heating Capacity Tables - 2-pipe

5

FWV-DAT
FWL-DAT
FWM-DAT

Air Temperature		20		
Water Temperature		50		
Model		Heating capacity	Water flow	Water pressure drop
		W	l/h	kPa
FW 01 T	Max	2140	264	10
	Med	1730	213	6
	Min	1430	179	5
FW 15 T	Max	2200	298	12
	Med	2040	261	9
	Min	1710	216	7
FW 02 T	Max	2550	337	11
	Med	2160	292	8
	Min	1780	234	6
FW 25 T	Max	3200	415	13
	Med	2680	348	10
	Min	2070	275	6
FW 03 T	Max	3810	503	9
	Med	3080	408	6
	Min	2280	302	4
FW 35 T	Max	4780	340	4
	Med	3690	451	6
	Min	2810	340	10
FW 04 T	Max	5100	743	10
	Med	3900	561	6
	Min	2980	431	4
FW 06 T	Max	5950	818	12
	Med	4870	664	8
	Min	3960	544	6
FW 08 T	Max	7830	1152	10
	Med	6230	904	6
	Min	4770	681	4
FW 10 T	Max	10000	1376	16
	Med	7800	1071	11
	Max	5240	706	5

4TW60012-1B(13/13)

5 Capacity tables

5 - 4 Heating Capacity Tables - 4-pipe

FWV-DAF FWL-DAF FWM-DAF													
Air Temperature (°C)		20											
Water Temperature (Entering °C - leaving °C)		45 - 40			60 - 50			70 - 60			90 - 70		
Model		Heating capacity	Water flow	Water pressure drop	Heating capacity	Water flow	Water pressure drop	Heating capacity	Water flow	Water pressure drop	Heating capacity	Water flow	Water pressure drop
		W	l/h	kPa	W	l/h	kPa	W	l/h	kPa	W	l/h	kPa
FW 01 F	Max	920	161	6	1420	124	3	1900	167	6	2470	109	3
	Med	820	143	5	1270	111	3	1700	149	5	2220	98	2
	Min	720	126	4	1110	97	2	1500	132	4	1950	86	2
FW 15 F	Max	980	170	8	1510	132	5	2020	177	8	2620	115	4
	Med	860	150	7	1330	116	4	1780	156	7	2320	102	3
	Min	750	131	5	1160	101	3	1560	137	5	2030	89	2
FW 02 F	Max	980	170	8	1500	131	5	2010	176	7	2600	115	3
	Med	860	150	6	1330	116	4	1780	156	6	2310	102	3
	Min	750	131	5	1160	101	3	1560	137	5	2020	89	2
FW 25 F	Max	1390	241	4	2120	185	3	2920	257	4	3740	165	2
	Med	1190	208	3	1820	159	2	2530	222	3	3220	142	2
	Min	970	169	2	1480	130	1	2060	181	2	2630	116	1
FW 03 F	Max	1470	255	5	2240	196	3	3080	270	5	3960	175	2
	Med	1260	220	4	1930	169	2	2680	235	4	3420	151	2
	Min	1030	179	3	1570	137	2	2180	191	3	2780	123	1
FW 35 F	Max	2340	406	9	3610	315	5	4800	421	9	6250	276	4
	Med	1930	336	6	2980	260	4	3960	347	6	5180	229	3
	Min	1560	270	4	2410	210	3	3210	282	4	4220	186	2
FW 04 F	Max	2460	427	13	3790	331	8	5050	443	12	6580	290	6
	Med	2070	360	9	3200	280	6	4250	373	9	5560	245	4
	Min	1750	304	7	2710	237	4	3600	316	7	4730	209	3
FW 06 F	Max	2580	448	12	3970	347	7	5300	465	12	6890	304	5
	Med	2260	393	10	3490	305	6	4650	408	9	6060	268	4
	Min	1970	343	8	3050	266	5	4040	355	7	5290	234	3
FW 08 F	Max	3890	675	31	6020	526	19	7910	694	30	10410	460	14
	Med	3360	584	24	5210	456	15	6830	600	23	9020	398	11
	Min	2800	486	18	4350	380	11	5690	499	17	7540	333	8
FW 10 F	Max	4100	713	37	6340	554	23	8350	733	36	10950	484	16
	Med	3510	610	28	5430	475	17	7140	627	27	9390	414	13
	Min	2710	470	18	4200	367	11	5500	483	17	7260	321	8

4TW60012-1B(11/13)

5 Capacity tables

5 - 4 Heating Capacity Tables - 4-pipe

5

FWV-FWL-FWM-DAF													
Air Temperature (°C)		22											
Water Temperature (Entering °C - leaving °C)		45 - 40			60 - 50			70 - 60			90 - 70		
Model		Heating capacity	Water flow	Water pressure drop	Heating capacity	Water flow	Water pressure drop	Heating capacity	Water flow	Water pressure drop	Heating capacity	Water flow	Water pressure drop
		W	l/h	kPa	W	l/h	kPa	W	l/h	kPa	W	l/h	kPa
FW 01 F	Max	830	144	5	1320	115	3	1810	159	5	2370	105	2
	Med	740	128	4	1180	103	2	1620	142	4	2130	94	2
	Min	650	113	3	1040	91	2	1430	125	3	1870	83	2
FW 15 F	Max	880	153	7	1400	123	4	1920	168	8	2510	111	3
	Med	770	134	6	1240	108	4	1690	149	6	2230	98	3
	Min	670	117	4	1080	94	3	1480	130	5	1940	86	2
FW 02 F	Max	870	152	6	1400	122	4	1910	167	7	2500	110	3
	Med	770	134	5	1230	108	3	1690	148	6	2220	98	3
	Min	670	117	4	1080	94	3	1480	130	4	1940	86	2
FW 25 F	Max	1230	214	4	1960	171	2	2770	244	4	3580	158	2
	Med	1060	184	3	1690	148	2	2400	210	3	3090	136	1
	Min	860	150	2	1370	120	1	1950	171	2	2510	111	1
FW 03 F	Max	1300	227	4	2080	181	3	2930	257	5	3790	167	2
	Med	1120	195	3	1790	156	2	2530	222	4	3270	144	2
	Min	910	158	2	1450	127	1	2060	181	3	2660	118	1
FW 35 F	Max	2100	366	7	3370	294	5	4560	400	8	6010	265	4
	Med	1730	301	5	2780	243	3	3760	330	6	4980	220	3
	Min	1390	242	4	2240	196	2	3050	268	4	4050	179	2
FW 04 F	Max	2210	385	11	3540	310	7	4800	421	11	6320	279	5
	Med	1860	324	8	2990	261	5	4040	354	8	5340	236	4
	Min	1570	273	6	2520	220	4	3420	300	6	4550	201	3
FW 06 F	Max	2320	403	10	3710	324	6	5040	442	11	6630	292	5
	Med	2040	354	8	3260	285	5	4420	387	9	5830	257	4
	Min	1770	308	6	2840	248	4	3840	337	7	5090	225	3
FW 08 F	Max	3510	610	26	5640	493	17	7530	660	27	10020	443	13
	Med	3040	528	20	4890	427	13	6500	570	21	8680	383	10
	Min	2530	440	15	4080	356	10	5410	475	15	7260	320	7
FW 10 F	Max	3700	644	31	5940	519	20	7950	697	33	10540	465	15
	Med	3170	551	24	5090	444	15	6790	596	25	9030	399	12
	Min	2450	425	15	3940	344	10	5230	459	16	6990	309	7

4TW60012-1B(12/13)

5 Capacity tables

5 - 5 Cooling Capacity Tables Glycol 30 %

Cooling mode

Glycol percentage in weight	Freezing temperature (°C)	Capacity correction factor	Pressure drop correction factor
0	0	1	1.00
10	-4	0.93	1.09
20	-10	0.84	1.18
30	-16	0.76	1.27
40	-24	0.76	1.36

Heating mode

Glycol percentage in weight	Freezing temperature (°C)	Capacity correction factor	Pressure drop correction factor
0	0	1	1.00
10	-4	0.98	1.08
20	-10	0.97	1.11
30	-16	0.94	1.22
40	-24	0.91	1.33

4TW60228-1B

Correction factors are based on an average value (at rated water flow rate). This can cause deviation depending on conditions used. The Fan Coil Selection software will provide an accurate result at all conditions.

5 Capacity tables

5 - 6 Capacity Correction Factor

5

FVV-DAT/DAF
FWL-DAT/DAF
FWM-DAT/DAF

	ESP	10		20		30		40		50		60	
		Fan Speed	F1	F2	F1	F2	F1	F2	F1	F2	F1	F2	F1
FW01	max	0.86	0.91	0.72	0.80	0.56	0.67	-	-	-	-	-	-
	med	0.78	0.84	0.56	0.65	0.33	0.41	-	-	-	-	-	-
	min	0.71	0.77	0.35	0.40	-	-	-	-	-	-	-	-
FW15	max	0.88	0.92	0.76	0.83	0.65	0.74	0.53	0.64	0.42	0.53	0.31	0.41
	med	0.83	0.88	0.68	0.75	0.54	0.63	0.40	0.49	0.27	0.38	-	-
	min	0.79	0.83	0.59	0.65	0.38	0.48	0.17	0.27	-	-	-	-
FW02	max	0.85	0.89	0.73	0.78	0.61	0.67	0.5	0.57	0.40	0.47	0.31	0.36
	med	0.82	0.85	0.63	0.68	0.45	0.50	0.27	0.30	-	-	-	-
	min	0.78	0.80	0.55	0.59	0.35	0.37	-	-	-	-	-	-
FW25	max	0.91	0.94	0.81	0.86	0.69	0.77	0.56	0.66	0.4	0.5	0.18	0.28
	med	0.86	0.89	0.70	0.76	0.54	0.61	0.36	0.44	0.15	0.24	-	-
	min	0.80	0.83	0.55	0.60	0.22	0.31	-	-	-	-	-	-
FW03	max	0.89	0.91	0.77	0.81	0.64	0.69	0.51	0.56	0.36	0.40	0.18	0.21
	med	0.82	0.84	0.64	0.67	0.47	0.50	0.29	0.32	-	-	-	-
	min	0.75	0.77	0.48	0.50	-	-	-	-	-	-	-	-
FW35	max	0.93	0.95	0.85	0.89	0.76	0.81	0.66	0.73	0.54	0.61	0.37	0.44
	med	0.90	0.92	0.80	0.83	0.69	0.72	0.56	0.60	0.42	0.51	0.24	0.36
	min	0.83	0.83	0.67	0.73	0.49	0.61	0.31	0.44	-	-	-	-
FW04	max	0.93	0.95	0.85	0.89	0.77	0.82	0.67	0.73	0.56	0.63	0.42	0.50
	med	0.91	0.93	0.81	0.84	0.71	0.75	0.59	0.64	0.46	0.51	0.31	0.35
	min	0.84	0.86	0.68	0.71	0.52	0.55	0.34	0.36	-	-	-	-
FW06	max	0.93	0.95	0.85	0.89	0.77	0.81	0.67	0.73	0.56	0.62	0.41	0.47
	med	0.92	0.93	0.82	0.86	0.73	0.77	0.61	0.66	0.48	0.53	0.31	0.36
	min	0.86	0.88	0.71	0.74	0.56	0.59	0.40	0.43	0.23	0.25	-	-
FW08	max	0.96	0.96	0.91	0.92	0.86	0.88	0.80	0.83	0.74	0.78	0.67	0.71
	med	0.95	0.96	0.90	0.92	0.85	0.87	0.79	0.81	0.73	0.76	0.65	0.69
	min	0.91	0.92	0.81	0.82	0.71	0.73	0.60	0.62	0.49	0.51	0.37	0.39
FW10	max	0.96	0.97	0.92	0.93	0.87	0.89	0.82	0.85	0.77	0.81	0.72	0.76
	med	0.95	0.96	0.90	0.91	0.84	0.86	0.78	0.81	0.71	0.75	0.64	0.68
	min	0.92	0.93	0.84	0.86	0.76	0.78	0.67	0.69	0.57	0.60	0.47	0.50

		FW01		FW15		FW02		FW025		FW03		FW35		FW4		FW6		FW8		FW10	
		medium	low	medium	low	medium	low	medium	low	medium	low	medium	low	medium	low	medium	low	medium	low	medium	low
Total cooling Capacity	TCC	0.81	0.68	0.87	0.72	0.87	0.69	0.84	0.66	0.81	0.60	0.75	0.56	0.76	0.58	0.81	0.66	0.79	0.59	0.78	0.52
Sensible cooling Capacity	SCC	0.81	0.66	0.88	0.73	0.87	0.70	0.84	0.63	0.81	0.60	0.74	0.53	0.78	0.57	0.80	0.64	0.78	0.58	0.77	0.51
Heating Capacity 2 pipe	HC2P	0.81	0.66	0.93	0.78	0.83	0.68	0.84	0.65	0.81	0.59	0.77	0.59	0.76	0.58	0.82	0.66	0.79	0.61	0.78	0.52
Heating Capacity 4 pipe	HC4P	0.85	0.73	0.88	0.77	0.89	0.78	0.87	0.71	0.87	0.71	0.83	0.67	0.83	0.69	0.88	0.76	0.86	0.72	0.85	0.66

Working conditions:

Cooling Air : 27°C DB - 19°C WB - Water : Entering 7°C - leaving 12°C
 Heating 2 pipe Air : 20°C Water : entering 50°C water flow as for cooling
 Heating 4 pipe Air : 20°C Water : entering 70°C- leaving 60°C

F1 = correction factor for air flow
 F2 = correction factor for capacities

Correction factors are based on an average value. This can cause deviation depending on conditions used. The Fan Coil Selection software will provide an accurate result at all conditions.

4TW60018-1B

6 Power consumption

6 - 1 Power Consumption - 2-pipe

FWV-DAT
FWL-DAT
FWM-DAT

FW08	MAX		MED		MIN	
	Power input (W)	Current (A)	Power input (W)	Current (A)	Power input (W)	Current (A)
0	182	0.802	127	0.570	86	0.393
10	178	0.780	126	0.560	83	0.385
20	174	0.761	123	0.547	82	0.377
30	169	0.741	120	0.532	81	0.371
40	166	0.721	118	0.522	80	0.363
50	161	0.698	116	0.509	78	0.354
60	157	0.680	113	0.497		
70	153	0.662	110	0.482		
80	147	0.639				
90	142	0.620				
100	137	0.595				

4TW60011-2C (9/20)

FWV-DAT
FWL-DAT
FWM-DAT

FW15	MAX		MED		MIN	
	Power input (W)	Current (A)	Power input (W)	Current (A)	Power input (W)	Current (A)
0	53	0.240	36	0.160	25	0.120
10	52	0.235	32	0.142	22	0.098
20	48	0.217	31	0.138	21	0.096
30	46	0.208	31	0.138	20	0.092
40	46	0.208	30	0.133		

4TW60011-2C (2/20)

6 Power consumption

6 - 1 Power Consumption - 2-pipe

6

FWV-DAT
FWL-DAT
FWM-DAT

FW01	MAX		MED		MIN	
	Power input (W)	Current (A)	Power input (W)	Current (A)	Power input (W)	Current (A)
0	37	0.170	28	0.130	21	0.100
10	37	0.160	26	0.120	21	0.090
20	35	0.150	25	0.110	20	0.088
30	35	0.150	24	0.110		
45	34	0.140				
50	33	0.140				

4TW60011-2C (1/20)

FWV-DAT
FWL-DAT
FWM-DAT

FW02	MAX		MED		MIN	
	Power input (W)	Current (A)	Power input (W)	Current (A)	Power input (W)	Current (A)
0	53	0.240	36	0.160	24	0.110
10	52	0.235	32	0.142	21	0.096
20	48	0.217	31	0.138	21	0.096
30	46	0.208	31	0.138	20	0.092
40	46	0.208	30	0.133		

4TW60011-2C (3/20)

6 Power consumption

6 - 1 Power Consumption - 2-pipe

FWV-DAT
FWL-DAT
FWM-DAT

FW25	MAX		MED		MIN	
	Power input (W)	Current (A)	Power input (W)	Current (A)	Power input (W)	Current (A)
0	57	0.265	44	0.204	29	0.138
10	56	0.252	43	0.199	29	0.134
20	53	0.239	41	0.191	29	0.131
30	53	0.239	41	0.191	28	0.130
40	52	0.234	40	0.186		
50	51	0.230				

4TW60011-2C (4/20)

FWV-DAT
FWL-DAT
FWM-DAT

FW03	MAX		MED		MIN	
	Power input (W)	Current (A)	Power input (W)	Current (A)	Power input (W)	Current (A)
0	56	0.252	43	0.200	29	0.138
10	55	0.248	42	0.195	29	0.134
20	53	0.239	41	0.191	29	0.131
30	53	0.239	41	0.191	28	0.130
40	52	0.234	40	0.186		
50	51	0.230				

4TW60011-2C (5/20)

6 Power consumption

6 - 1 Power Consumption - 2-pipe

6

FWV-DAT
FWL-DAT
FWM-DAT

FW35 AP (Pa)	MAX		MED		MIN	
	Power input (W)	Current (A)	Power input (W)	Current (A)	Power input (W)	Current (A)
0	98	0,440	61	0,287	37	0,192
10	94	0,422	59	0,276	37	0,187
20	92	0,413	57	0,259	36	0,182
30	90	0,404	55	0,254	34	0,172
40	88	0,395	53	0,242	31	0,157
50	85	0,382	50	0,228		
60	81	0,364	45	0,211		
70	76	0,341				
75	74	0,332				

4TW60011-2C (6/20)

FWV-DAT
FWL-DAT
FWM-DAT

FW04 AP (Pa)	MAX		MED		MIN	
	Power input (W)	Current (A)	Power input (W)	Current (A)	Power input (W)	Current (A)
0	98	0,440	61	0,287	38	0,192
10	94	0,422	59	0,276	37	0,187
20	92	0,413	57	0,259	36	0,182
30	90	0,404	55	0,254	34	0,172
40	88	0,395	53	0,242	31	0,157
50	85	0,382	50	0,228		
60	81	0,364	45	0,211		
70	76	0,341				
75	74	0,332				

4TW60011-2C (7/20)

6 Power consumption

6 - 1 Power Consumption - 2-pipe

FWV-DAT
FWL-DAT
FWM-DAT

FW06	MAX		MED		MIN	
	Power input (W)	Current (A)	Power input (W)	Current (A)	Power input (W)	Current (A)
0	98	0.430	68	0.310	47	0.220
10	96	0.421	67	0.305	45	0.211
20	94	0.412	64	0.292	44	0.206
30	91	0.399	62	0.283	43	0.201
40	90	0.395	61	0.278	42	0.197
50	89	0.391	59	0.269		
60	86	0.377	56	0.255		
70	82	0.360				

4TW60011-2C (8/20)

FWV-DAT
FWL-DAT
FWM-DAT

FW10	MAX		MED		MIN	
	Power input (W)	Current (A)	Power input (W)	Current (A)	Power input (W)	Current (A)
0	244	1.106	169	0.760	109	0.500
10	238	1.078	164	0.753	108	0.490
20	232	1.050	160	0.735	107	0.480
30	225	1.020	155	0.711	106	0.480
40	214	0.960	151	0.690	104	0.470
50	207	0.925	147	0.673	102	0.460
60	199	0.900	143	0.656		
70	192	0.872	139	0.636		
80	188	0.847				
90	183	0.820				
100	176	0.799				

4TW60011-2C (10/20)

6 Power consumption

6 - 2 Power Consumption - 4-pipe

6

FWV-DAF
FWL-DAF
FWM-DAF

FW01	MAX		MED		MIN	
	Power input (W)	Current (A)	Power input (W)	Current (A)	Power input (W)	Current (A)
0	37	0.170	28	0.130	21	0.100
10	37	0.160	26	0.120	21	0.090
20	35	0.150	25	0.110	20	0.088
30	35	0.150	24	0.110		
45	34	0.140				
50	33	0.140				

4TW60011-2C (11/20)

FWV-DAF
FWL-DAF
FWM-DAF

FW15	MAX		MED		MIN	
	Power input (W)	Current (A)	Power input (W)	Current (A)	Power input (W)	Current (A)
0	53	0.240	36	0.160	25	0.120
10	52	0.235	32	0.142	22	0.098
20	48	0.217	31	0.138	21	0.096
30	46	0.208	31	0.138	20	0.092
40	46	0.208	30	0.133		

4TW60011-2C (12/20)

6 Power consumption

6 - 2 Power Consumption - 4-pipe

FWV-DAF
FWL-DAF
FWM-DAF

FW02	MAX		MED		MIN	
	Power input (W)	Current (A)	Power input (W)	Current (A)	Power input (W)	Current (A)
0	53	0.240	36	0.160	24	0.110
10	52	0.235	32	0.142	21	0.096
20	48	0.217	31	0.138	21	0.096
30	46	0.208	31	0.138	20	0.092
40	46	0.208	30	0.133		

4TW60011-2C (13/20)

FWV-DAF
FWL-DAF
FWM-DAF

FW25	MAX		MED		MIN	
	Power input (W)	Current (A)	Power input (W)	Current (A)	Power input (W)	Current (A)
0	57	0.265	44	0.204	29	0.138
10	56	0.252	43	0.199	29	0.134
20	53	0.239	41	0.191	29	0.131
30	53	0.239	41	0.191	28	0.130
40	52	0.234	40	0.186		
50	51	0.230				

4TW60011-2C (14/20)

6 Power consumption

6 - 2 Power Consumption - 4-pipe

6

FWV-DAF
FWL-DAF
FWM-DAF

FW03	MAX		MED		MIN	
	AP (Pa)	Power input (W)	Current (A)	Power input (W)	Current (A)	Power input (W)
0	56	0.252	43	0.200	29	0.138
10	55	0.248	42	0.195	29	0.134
20	53	0.239	41	0.191	29	0.131
30	53	0.239	41	0.191	28	0.130
40	52	0.234	40	0.186		
50	51	0.230				

4TW60011-2C (15/20)

FWV-DAF
FWL-DAF
FWM-DAF

FW04	MAX		MED		MIN	
	AP (Pa)	Power input (W)	Current (A)	Power input (W)	Current (A)	Power input (W)
0	98	0.440	61	0.287	38	0.192
10	94	0.422	59	0.276	37	0.187
20	92	0.413	57	0.259	36	0.182
30	90	0.404	55	0.254	34	0.172
40	88	0.395	53	0.242	31	0.157
50	85	0.382	50	0.228		
60	81	0.364	45	0.211		
70	76	0.341				
75	74	0.332				

4TW60011-2C (17/20)

6 Power consumption

6 - 2 Power Consumption - 4-pipe

FWV-DAF
FWL-DAF
FWM-DAF

FW06	MAX		MED		MIN	
	Power input (W)	Current (A)	Power input (W)	Current (A)	Power input (W)	Current (A)
0	98	0.430	68	0.310	47	0.220
10	96	0.421	67	0.305	45	0.211
20	94	0.412	64	0.292	44	0.206
30	91	0.399	62	0.283	43	0.201
40	90	0.395	61	0.278	42	0.197
50	89	0.391	59	0.269		
60	86	0.377	56	0.255		
70	82	0.360				

4TW60011-2C (18/20)

FWV-DAF
FWL-DAF
FWM-DAF

FW08	MAX		MED		MIN	
	Power input (W)	Current (A)	Power input (W)	Current (A)	Power input (W)	Current (A)
0	182	0.802	127	0.570	86	0.393
10	178	0.780	126	0.560	83	0.385
20	174	0.761	123	0.547	82	0.377
30	169	0.741	120	0.532	81	0.371
40	166	0.721	118	0.522	80	0.363
50	161	0.698	116	0.509	78	0.354
60	157	0.680	113	0.497		
70	153	0.662	110	0.482		
80	147	0.639				
90	142	0.620				
100	137	0.595				

4TW60011-2C (19/20)

6 Power consumption

6 - 2 Power Consumption - 4-pipe

FWV-DAF
FWL-DAF
FWM-DAF

FW10 AP (Pa)	MAX		MED		MIN	
	Power input (W)	Current (A)	Power input (W)	Current (A)	Power input (W)	Current (A)
0	244	1.106	169	0.760	109	0.500
10	238	1.078	164	0.753	108	0.490
20	232	1.050	160	0.735	107	0.480
30	225	1.020	155	0.711	106	0.480
40	214	0.960	151	0.690	104	0.470
50	207	0.925	147	0.673	102	0.460
60	199	0.900	143	0.656		
70	192	0.872	139	0.636		
80	188	0.847				
90	183	0.820				
100	176	0.799				

4TW60011-2C (20/20)

7 Dimensional drawings

7 - 1 Dimensional Drawings

FWM-DAT/DAF

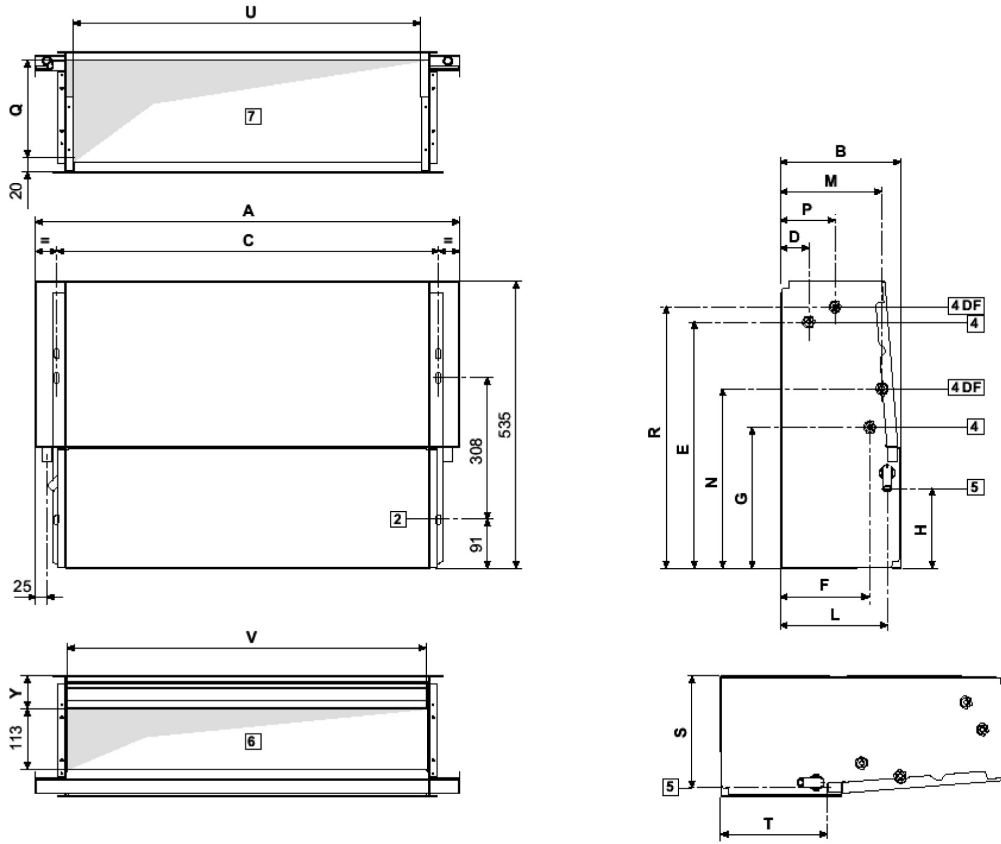

	A	B	C	D	E	F	G	H	L	M	N	P	Q	R	S	T	U	V	W
FWM 01+15+02	584	224	498	51	458	163	263	149	198	187	335	99	189	486	208	198	436	464	61
FWM 25+03	794	224	708	51	458	163	263	149	198	187	335	99	189	486	208	198	646	674	61
FWM 35+04+06	1004	224	918	51	458	163	263	149	198	187	335	99	189	486	208	198	856	884	61
FWM 08+10	1214	249	1128	48	497	185	259	155	220	195	348	120	215	478	234	208	1066	1094	67

Minimum required installation space

Keep at least 100 mm of free space at air inlet for a proper air suction and an easy removal of the filter.

For ducted units the outlet/inlet grill surface must be at least equal to the outlet/inlet surface of the unit to avoid extra noise and strong performances reduction.

LEGENDA

- | | |
|--|--|
| 1. Clear space for hydraulic connections (*) | 6. Air outlet for concealed models |
| 2. Slots for wall/ceiling mounting 9 x 20 mm | 7. Air suction for concealed models |
| 3. Clear space for electric connections(*) | 8. Condensate draining for horizontal installation |
| 4. Hydraulic connections (4DF = 4 pipe system) | 9. Air outlet |
| 5. Condensate drainage for vertical installation | 10. Air inlet |

(*) indications applicable to units with hydraulic connections on the left side; in case of right side connections the indicators for "clear space" are reversed.

Hydraulic connections

Standard Heat exchanger : connection female

FW01	FW15	FW02	FW25	FW03	FW35	FW04	FW06	FW08	FW10
1/2"	1/2"	1/2"	1/2"	1/2"	1/2"	1/2"	1/2"	3/4"	3/4"

Additional Heat exchanger : connection female

FW01	FW15	FW02	FW25	FW03	FW35	FW04	FW06	FW08	FW10
1/2"	1/2"	1/2"	1/2"	1/2"	1/2"	1/2"	1/2"	1/2"	1/2"

4TW60014-1B(2)

8 Wiring diagrams

8 - 1 Wiring Diagrams - Single Phase

8

- SYMBOLS**
- BK Black = maximum speed
 - BU Blue = medium speed
 - GNYE Yellow/Green = earth connection
 - RD Red = minimum speed
 - WH White = common
 - Field wiring
 - F Protection fuse (field supply)
 - IL Main switch (field supply)
 - M Fan motor
 - PE Earth connection

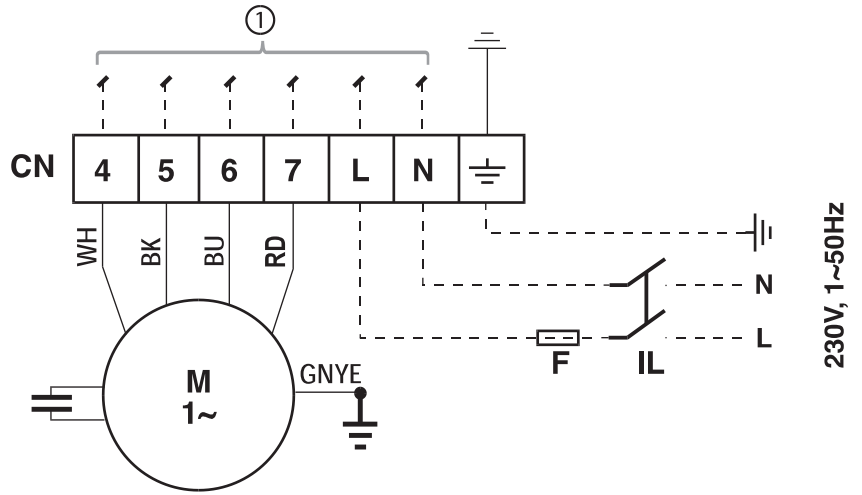

4TW60016-1

9 Sound data

9 - 1 Sound Level Data - 2-pipe

FWV-DAT
FWL-DAT
FWM-DAT

Sound power level and Spectrum

FW01 T								
Sound Power Levels dB(A)	125 Hz	250 Hz	500 Hz	1000 Hz	2000 Hz	4000 Hz	8000 Hz	Global Lw
max	26.7	41.0	43.5	40.3	35.5	23.5	17.5	47
med	22.4	37.1	38.9	33.3	27.3	18.8	18.4	42
min	17.5	33.7	32.9	26.0	20.2	19.2	19.2	37
FW15 T								
Sound Power Levels dB(A)	125 Hz	250 Hz	500 Hz	1000 Hz	2000 Hz	4000 Hz	8000 Hz	Global Lw
max	28.7	43.0	45.5	42.3	37.5	25.5	19.5	49
med	24.4	39.1	40.9	35.3	29.3	20.8	20.4	44
min	18.5	34.7	33.9	27.0	21.2	20.2	20.2	38
FW02 T								
Sound Power Levels dB(A)	125 Hz	250 Hz	500 Hz	1000 Hz	2000 Hz	4000 Hz	8000 Hz	Global Lw
max	29.3	43.2	46.2	44.1	39.7	30.3	17.7	50
med	23.2	38.1	41.0	36.5	30.6	20.0	15.8	44
min	19.8	34.9	37.2	30.8	24.4	17.3	17.1	40
FW25 T								
Sound Power Levels dB(A)	125 Hz	250 Hz	500 Hz	1000 Hz	2000 Hz	4000 Hz	8000 Hz	Global Lw
max	28.8	42.0	44.6	41.5	35.1	24.5	19.1	48
med	24.9	37.9	39.8	34.9	27.7	20.3	18.6	43
min	18.0	31.2	31.1	24.3	19.6	18.3	18.0	35
FW03 T								
Sound Power Levels dB(A)	125 Hz	250 Hz	500 Hz	1000 Hz	2000 Hz	4000 Hz	8000 Hz	Global Lw
max	28.8	42.0	44.6	41.5	35.1	24.5	19.1	48
med	23.9	36.9	38.8	33.9	26.7	19.3	17.6	42
min	17.0	30.2	30.1	23.3	18.6	17.3	17.0	34
FW35 T								
Sound Power Levels dB(A)	125 Hz	250 Hz	500 Hz	1000 Hz	2000 Hz	4000 Hz	8000 Hz	Global Lw
max	31.7	45.4	47.7	45.4	41.7	32.0	19.2	52
med	23.6	37.6	39.8	34.2	28.7	21.6	16.5	43
min	17.8	31.8	31.5	24.4	17.2	16.5	15.4	35
FW04 T								
Sound Power Levels dB(A)	125 Hz	250 Hz	500 Hz	1000 Hz	2000 Hz	4000 Hz	8000 Hz	Global Lw
max	33.1	46.8	49.0	46.8	43.1	33.4	20.5	53
med	23.6	37.6	39.8	34.2	28.7	21.6	16.5	43
min	17.8	31.8	31.5	24.4	17.2	16.5	15.4	35
FW06 T								
Sound Power Levels dB(A)	125 Hz	250 Hz	500 Hz	1000 Hz	2000 Hz	4000 Hz	8000 Hz	Global Lw
max	36.1	49.3	51.4	50.6	47.4	39.1	24.7	56
med	28.9	43.0	45.2	42.3	38.1	28.1	17.9	49
min	23.7	37.4	39.8	34.4	28.6	21.9	16.8	43
FW08 T								
Sound Power Levels dB(A)	125 Hz	250 Hz	500 Hz	1000 Hz	2000 Hz	4000 Hz	8000 Hz	Global Lw
max	40.4	54.6	56.1	54.9	53.1	46.8	35.6	61
med	33.7	48.0	49.5	47.8	45.2	36.3	24.0	54
min	28.1	42.1	42.4	40.7	35.9	26.1	21.5	47
FW10 T								
Sound Power Levels dB(A)	125 Hz	250 Hz	500 Hz	1000 Hz	2000 Hz	4000 Hz	8000 Hz	Global Lw
max	45.8	59.2	61.4	61.6	59.7	54.9	47.6	67
med	39.2	52.2	55.5	54.2	52.1	45.8	35.3	60
min	28.7	43.2	44.7	42.6	39.2	29.5	21.6	49
Conditions of measurements	ISO3741 : in case of (M) models the sound power is calculated WITHOUT any additional inlet or outlet grill or plenum !							

To calculate the sound pressure you must define some conditions and use this formula

$$L_p = L_w - 10 \times \log_{10} \left(\frac{4\pi \times d^2}{Q} \right)$$

Where :

- Q = direction factor : is Q=4 if the FCU is installed near 2 walls (vertical or floor-ceiling), Q=2 if the FCU is installed near 1 wall (at floor or ceiling but faraway the 2nd wall)
- d = distance (mt) from the sound source and the measure point
- Lp = sound pressure (dB A)
- Lw = sound power (dB A)

9 Sound data

9 - 2 Sound Level Data - 4-pipe

9

FWV-DAF
FWL-DAF
FWM-DAF

Sound power level and Spectrum

FW01 F								
Sound Power Levels dB(A)	125 Hz	250 Hz	500 Hz	1000 Hz	2000 Hz	4000 Hz	8000 Hz	Global Lw
max	24.8	39.1	41.7	38.4	33.7	21.6	15.6	45
med	19.4	34.1	35.9	30.3	24.3	15.8	15.4	39
min	13.6	29.7	29.0	22.0	16.2	15.2	15.2	33
FW15 F								
Sound Power Levels dB(A)	125 Hz	250 Hz	500 Hz	1000 Hz	2000 Hz	4000 Hz	8000 Hz	Global Lw
max	28.3	42.2	45.2	43.1	38.7	29.3	16.7	49
med	22.9	37.8	40.7	36.2	30.3	19.6	15.4	44
min	18.0	33.1	35.4	29.1	22.7	15.5	15.3	38
FW02 F								
Sound Power Levels dB(A)	125 Hz	250 Hz	500 Hz	1000 Hz	2000 Hz	4000 Hz	8000 Hz	Global Lw
max	28.8	42.7	45.8	43.6	39.3	29.9	17.2	50
med	22.9	37.8	40.7	36.2	30.3	19.6	15.4	44
min	18.0	33.1	35.4	29.1	22.7	15.5	15.3	38
FW25 F								
Sound Power Levels dB(A)	125 Hz	250 Hz	500 Hz	1000 Hz	2000 Hz	4000 Hz	8000 Hz	Global Lw
max	28.8	42.0	44.6	41.5	35.1	24.5	19.1	48
med	24.9	37.9	39.8	34.9	27.7	20.3	18.6	43
min	17.0	30.2	30.1	23.3	18.6	17.3	17.0	34
FW03 F								
Sound Power Levels dB(A)	125 Hz	250 Hz	500 Hz	1000 Hz	2000 Hz	4000 Hz	8000 Hz	Global Lw
max	27.8	40.9	43.5	40.4	34.0	23.4	18.0	47
med	23.0	36.0	37.9	33.0	25.7	18.4	16.6	41
min	15.6	28.8	28.8	22.0	17.2	16.0	15.6	33
FW35 F								
Sound Power Levels dB(A)	125 Hz	250 Hz	500 Hz	1000 Hz	2000 Hz	4000 Hz	8000 Hz	Global Lw
max	31.1	44.8	47.0	44.8	41.1	31.4	18.5	51
med	23.7	37.8	40.0	34.4	28.9	21.8	16.7	43
min	16.5	30.5	30.2	23.1	15.9	15.2	14.1	34
FW04 F								
Sound Power Levels dB(A)	125 Hz	250 Hz	500 Hz	1000 Hz	2000 Hz	4000 Hz	8000 Hz	Global Lw
max	36.1	49.8	52.0	49.8	46.1	36.4	23.5	56
med	26.7	40.8	43.0	37.4	31.9	24.8	19.7	46
min	19.5	33.5	33.2	26.1	18.9	18.2	17.1	37
FW06 F								
Sound Power Levels dB(A)	125 Hz	250 Hz	500 Hz	1000 Hz	2000 Hz	4000 Hz	8000 Hz	Global Lw
max	39.0	52.2	54.4	53.5	50.3	42.0	27.6	59
med	33.0	47.1	49.3	46.3	42.1	32.2	22.0	53
min	28.9	42.7	45.0	39.7	33.8	27.1	22.0	48
FW08 F								
Sound Power Levels dB(A)	125 Hz	250 Hz	500 Hz	1000 Hz	2000 Hz	4000 Hz	8000 Hz	Global Lw
max	39.4	53.6	55.1	53.9	52.1	45.8	34.6	60
med	33.7	48.0	49.5	47.8	45.2	36.3	24.0	54
min	27.1	41.1	41.4	39.7	34.9	25.1	20.5	46
FW10 F								
Sound Power Levels dB(A)	125 Hz	250 Hz	500 Hz	1000 Hz	2000 Hz	4000 Hz	8000 Hz	Global Lw
max	44.8	58.2	60.4	60.6	58.7	53.9	46.6	66
med	37.2	50.2	53.5	52.2	50.1	43.8	33.3	58
min	27.7	42.2	43.7	41.6	38.2	28.5	20.6	48
Conditions of measurements	ISO3741 : in case of (M) models the sound power is calculated WITHOUT any additional inlet or outlet grill or plenum !							

To calculate the sound pressure you must define some conditions and use this formula

$$L_p = L_w - 10 \times \log_{10} \left(\frac{4\pi \times d^2}{Q} \right)$$

Where :

- Q = direction factor : is Q=4 if the FCU is installed near 2 walls (vertical or floor-ceiling), Q=2 if the FCU is installed near 1 wall (at floor or ceiling but faraway the 2° wall)
- d = distance (mt) from the sound source and the measure point
- Lp = sound pressure (dB A)
- Lw = sound power (dB A)

10 Installation

10 - 1 Installation Method

Fan coil units should be installed in a position where they heat and cool the room evenly, on walls or ceilings that can bear their weight. Fit any accessories on the standard unit before installing it. Read the relevant technical sheets for the installation and use of the accessories. Keep free space around the fan coil to allow proper operation and ordinary and extraordinary maintenance (see the "9. Dimensional drawings") Provide a panel to reach the unit in case of recessed mounting (Concealed models). Install the remote control panel, if any, in a position that can easily be reached by the user to set the functions and that is suitable for the proper detection of the temperature, if provided.

Therefore avoid:

- positions directly exposed to sunlight;
- positions exposed to hot or cold draughts;
- obstacles preventing the proper temperature detection

If the system is shut down during the winter months, drain off the water from the system to prevent damage due to freezing; if antifreeze solutions are used, check the freezing point using the table shown on technical manual.

Keep at least 100 mm of free space at air inlet for a proper air suction and an easy removal of the filter.

For ducted units the outlet/inlet grill surface must be at least equal to the outlet/inlet surface of the unit to avoid extra noise and strong performance reduction.

BEFORE THE INSTALLATION

Installation and maintenance should be carried out by technical personnel qualified for this type of machine, in compliance with current safety regulations.

For installation and use of possible accessories please refer to the pertinent technical sheets.

In choosing where to install the unit, comply with the following points:

- the heating unit should not be placed immediately under a socket
 - do not install the unit in rooms where inflammable gases are present
 - do not let water is sprayed directly on the unit
 - install the unit on ceilings or walls that bear its weight. Leave enough space all around for proper operation and maintenance of the unit.
- Keep the unit in its packaging until it is ready to be installed, to prevent dust getting inside it.

INSTALLATION WARNING:

On the fan coil install a switch (IL) and/or all remote controls in a position out of the reach of persons who are in a bathtub or shower.

In case of ceiling-mounted models, check that the installation height does not exceed the maximum height shown in 7. Dimensional drawings in order to avoid excessive hot air stratification in the upper part of the room; in case of greater installation heights we suggest to proceed with the back suction from the lower part of the room. The installation heights shown in the figure refer to the maximum running speed.

Carry out the hydraulic connections to the heat exchanger and in case of cooling operation, to the water drainage system. We suggest to provide for the water inlet from the bottom side of the heat exchanger and the outlet on the upper side. Bleed the air from the heat exchanger operating on the air-vent valves (10 hexagon wrench) located beside the water connections of the heat exchanger. For a better water drainage lean the drain pipe downwards at least 3 cm/m avoiding loops or narrowing on its way.

INSTALLATION FOR THE CONCEALED CEILING MODEL

The air outlets should not be placed immediately under a socket. For the concealed ceiling model, perform the connection between the fan coil and the ducts, and place damping material between the duct and the unit. The ducts, in particular the outlet ones, must be insulated. In order to avoid air back suction on the fan coil, keep a minimum distance between the air outlet and recovered air flow as shown in installation manual of the unit. The minimum installation height should not be lower than 1.8 metres from floor level. Provide for an inspection port to the unit.

10 Installation

10 - 1 Installation Method

10

ELECTRICAL CONNECTIONS

Carry out the electrical wiring after having turned the power off in compliance with the relevant local and national regulations following the relevant wiring diagram.

Check that the power supply corresponds to the rated power reported on the unit nameplate.

Each fan coil requires a switch (IL) on the feeder line with a distance of at least 3 mm between the opening contacts, and a suitable safety fuse (F).

USE

To use the fan coil unit, refer to the instructions of the control panel, available as accessory.

Air outlet grids on the cover cabinet (wall mounted and floor/ceiling mounted) can be turned 180° to direct the flow into the room or towards the wall on which the unit is mounted. The grids and the side doors are snapped into the cabinet. Before removing them in order to change their position, cut the power off and wear protective gloves.

MAINTENANCE

For safety reasons before carrying out any maintenance or cleaning operation, switch off the unit turning the selection switch to "Stop" and the power supply switch on position 0 (OFF).

Be careful during any maintenance operation; you could get injured by some metal parts; use protective work gloves. The fan coils do not require any particular maintenance operation: only the periodical cleaning of the air filter should be carried out. It is necessary to carry out a running in period of 100 hours in order to eliminate all mechanical friction. The starting up must be carried out at the maximum speed.

For good operation of the fan coils follow the instructions below:

- keep the air filter clean;
- do not pour liquids into the unit;
- do not introduce metal parts through the air outlet grid;
- keep the air inlet and outlet free at all times.

Each time the machine is turned on after being idle for a long period, ensure there is no air in the heat exchanger. Before using the unit for air conditions, check that:

- condensate drainage is performed correctly;
- the heat exchanger fins are not obstructed by deposits of dirt.

If necessary clean the fins with low pressure compressed air or steam without damaging them.

CLEANING

For safety reasons before carrying out any maintenance or cleaning operation switch off the unit turning the selection switch to "Stop" and the power supply switch on 0 (OFF).

Clean the filter at least once a month and in any case before using the unit (before the heating or the air conditioning season).

For cleaning the air filter proceed as follows (pictures see manual of units):

- Floor models: turn the screws 90°, which secure the filter to the cover cabinet, to 1/4 turn and remove the filter;
- Concealed models: reach the fan coil through the inspection panel and remove the filter, turning the locking brackets 90°;
- Floor ceiling: remove the air filters that are inside the intake grids located on the front panel of the cover cabinet;
- clean the filter with lukewarm water, or in case of dry dust, with compressed air;
- reassemble the filter after having dried it up

It is recommended to replace the air filter yearly, and to use original spare parts; the fan coil model is reported on the nameplate located on the internal part of the side panel of the unit.

To clean the unit cabinet proceed as follows

- use a soft cloth;
- do not pour any liquid on the unit, as this could cause electrical shocks or damage the components inside it;
- do not use any aggressive chemical solvents; do not use very hot water to clean the air outlet grid

Note: this is only based text and should be combined with manuals for relative pictures and additional information.

11 Operation range

11 - 1 Operation Range

Minimum water temperature	+5°C
Maximum water temperature	+95°C
Maximum operating pressure	10 bar
Minimum air inlet temperature	5°C
Maximum air inlet temperature	+43°C
Power supply	230V +-10% / 1~ / 50Hz

4TW60013-1

12 Hydraulic performance

12 - 1 Water Pressure Drop Curve Evaporator - Cooling 2-pipe

12

FWV-DAT
FWL-DAT
FWM-DAT

Water Flow l/h	Water Pressure Drop									
	FW1 kPa	FW15 kPa	FW2 kPa	FW25 kPa	FW3 kPa	FW35 kPa	FW4 kPa	FW6 kPa	FW8 kPa	FW10 kPa
50	0.71	0.61	0.41	0.39	0.19	0.15	0.11	0.1	0.05	0.05
100	2.44	2.1	1.42	1.32	0.66	0.51	0.36	0.35	0.16	0.20
200	8.25	7.12	4.81	4.51	2.25	1.75	1.23	1.21	0.56	0.67
300	16.84	14.52	9.81	9.19	4.6	12.8	2.51	2.46	1.14	1.37
400	27.92	24.1	16.27	15.25	7.63	5.93	4.17	4.09	1.9	2.29
500	41.33	35.65	24.09	22.58	11.3	8.78	6.18	6.06	2.82	3.39
600	56.93	49.12	33.19	31.11	15.57	12.1	8.51	8.35	3.89	4.68
800	94.32	81.42	55.02	51.59	25.82	20.07	14.12	13.84	6.44	7.75
1000	139.51	120.47	81.4	76.35	38.2	29.72	20.9	20.5	9.54	11.48
1500			165.77	155.58	77.83	60.58	42.61	41.8	19.46	23.42
2000					128.9	100.38	70.59	69.27	32.27	38.85
2500						148.48	104.41	102.47	47.75	57.50
3000							143.74	141.09	65.76	79.22
4000									108.92	131.28
5000									161.06	194.20

4TW60019-1B(1)

12 Hydraulic performance

12 - 2 Water Pressure Drop Curve Evaporator - Heating 2-pipe

FWV-DAT
FWL-DAT
FWM-DAT

Water Flow l/h	Water Pressure Drop									
	FW1 kPa	FW15 kPa	FW2 kPa	FW25 kPa	FW3 kPa	FW35 kPa	FW4 kPa	FW6 kPa	FW8 kPa	FW10 kPa
50	0.61	0.53	0.36	0.34	0.17	0.13	0.09	0.09	0.04	0.04
100	2.02	1.76	1.19	1.12	0.56	0.44	0.31	0.31	0.14	0.17
200	6.72	5.84	3.94	3.73	1.86	1.47	1.02	1.01	0.47	0.58
300	13.6	11.82	7.97	7.54	3.75	2.96	2.07	2.04	0.96	1.16
400	22.45	19.49	13.14	12.42	6.18	4.87	3.41	3.36	1.57	1.91
500	33.14	28.74	19.39	18.31	9.12	7.18	5.02	4.95	2.32	2.81
600	45.55	39.49	26.64	25.14	12.53	9.95	6.89	6.79	3.18	3.86
800	75.27	65.23	44.01	41.49	20.69	16.24	11.38	11.2	5.24	6.36
1000	111.15	96.28	64.97	61.23	30.54	23.95	16.79	16.52	7.72	9.37
1500					62.01	48.55	34.06	33.49	15.64	18.96
2000					102.52	80.2	56.28	55.34	25.84	31.29
2500							83.12	81.71	38.15	46.17
3000								112.36	52.45	63.45
4000									86.7	104.85
5000										154.82

4TW60019-1B(2)

12 Hydraulic performance

12 - 3 Water Pressure Drop Curve Evaporator - Heating 4-pipe

12

FWV-DAF
FWL-DAF
FWM-DAF

Water Flow l/h	Water Pressure Drop									
	FW1	FW15	FW2	FW25	FW3	FW35	FW4	FW6	FW8	FW10
	kPa	kPa	kPa	kPa	kPa	kPa	kPa	kPa	kPa	kPa
50	0.68	0.92	0.84	0.26	0.28	0.21	0.28	0.25	0.32	0.34
100	2.27	3.07	2.78	0.86	0.94	0.71	0.94	0.82	1.05	1.14
200	7.57	10.21	9.27	2.87	3.13	2.37	3.11	2.72	3.47	3.76
300	15.32	20.67	18.76	5.81	6.33	4.79	6.28	5.48	6.99	7.58
400	25.29	34.11	30.96	9.58	10.43	7.88	10.35	9.03	11.49	12.45
500	37.32	50.33	45.69	14.13	15.39	11.61	15.24	13.3	16.9	18.32
600	51.29	69.18	62.8	19.42	21.14	15.95	20.93	18.26	23.19	25.13
800	84.76	114.31	103.76	32.07	34.91	26.31	34.52	30.12	38.2	41.4
1000				47.34	51.53	38.82	50.93	44.43	56.31	61.02
1500				96.11	104.6	78.74	103.29	90.1	114.07	123.59

4TW60019-1B(3)



Daikin Europe N.V. Naamloze Vennootschap - Zandvoordestraat 300, B-8400 Oostende - Belgium - www.daikin.eu - BE 0412 120 336 - RPR Oostende

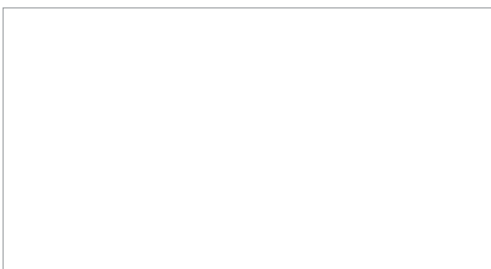

EEDEN17 06/17



Daikin Europe N.V. participates in the Eurovent Certification programme for Liquid Chilling Packages (LCP), Air handling units (AHU), Fan coil units (FCU) and variable refrigerant flow systems (VRF) Check ongoing validity of certificate online: www.eurovent-certification.com or using: www.certiflash.com



The present leaflet is drawn up by way of information only and does not constitute an offer binding upon Daikin Europe N.V.. Daikin Europe N.V. has compiled the content of this leaflet to the best of its knowledge. No express or implied warranty is given for the completeness, accuracy, reliability or fitness for particular purpose of its content and the products and services presented therein. Specifications are subject to change without prior notice. Daikin Europe N.V. explicitly rejects any liability for any direct or indirect damage, in the broadest sense, arising from or related to the use and/or interpretation of this leaflet. All content is copyrighted by Daikin Europe N.V.