



REV	06
Date	01/2023
Replace	D-EOMZC00106-17_05EN

**OPERATING MANUAL  
D-EOMZC00106-17\_06EN**

**WATER COOLED CHILLER AND HEAT PUMPS WITH  
INVERTER DRIVEN SCREW COMPRESSOR**

**MICROTECH™ CONTROLLER**

# TABLE OF CONTENTS

<b>1</b>	<b>SAFETY CONSIDERATIONS</b>	<b>6</b>
1.1	General	6
1.2	Avoid electrocution	6
1.3	Safety Devices	6
1.3.1	General safety devices	6
1.3.2	Circuit safety devices	6
1.3.3	Component safety devices	6
1.4	Available sensors	8
1.4.1	Pressure transducers	8
1.4.2	Temperature sensors	8
1.4.3	Thermistors	8
1.4.4	Leak detectors	8
1.5	Available Controls	8
1.5.1	Evaporator pumps	8
1.5.2	Condenser pumps (W/C units only)	8
1.5.3	Compressors	8
1.5.4	Expansion Valve	8
1.5.5	Evaporator Flow Switch	8
1.5.6	Condenser Flow Switch	8
1.5.7	Evaporator Three Way Valve (Optional)	9
1.5.8	Double setpoint	9
1.5.9	Current limit (optional)	9
1.5.10	External Fault	9
1.5.11	Rapid Restart (optional)	9
1.5.12	Remote On-Off	9
1.5.13	General Alarm	9
1.5.14	Compressor Status	9
1.5.15	Circuit Alarm (optional)	9
1.5.16	Evaporator Pump Start	9
1.5.17	Condenser Pump Start (W/C units only)	9
1.5.18	Demand limit	9
1.5.19	Setpoint override	10
<b>2</b>	<b>GENERAL DESCRIPTION</b>	<b>11</b>
2.1	Basic Information	11
2.2	Abbreviations used	11
2.3	Controller Operating Limits	11
2.4	Controller Architecture	11
2.5	Communication Modules	12
<b>3</b>	<b>USING THE CONTROLLER</b>	<b>13</b>
3.1	General Recommendation	13
3.2	Navigating	13
3.3	Passwords	14
3.4	Editing	14
3.5	Basic Control System Diagnostic	15
3.6	Controller maintenance	16
3.7	Optional Remote User Interface	16
3.8	Embedded Web Interface	17
<b>4</b>	<b>MENU STRUCTURE</b>	<b>18</b>
4.1	Main Menu	18
4.2	View/Set Unit	18
4.2.1	Thermostat Ctrl	19

4.2.2	Network Ctrl	19
4.2.3	Pumps	19
4.2.4	Condenser	20
4.2.5	Evaporator	20
4.2.6	Rapid Restart	20
4.2.7	Date/Time	20
4.2.8	Scheduler	21
4.2.9	Power Conservation	21
4.2.10	Controller IP setup	22
4.2.11	Daikin on Site	22
4.3	View/Set Circuit	22
4.3.1	Data	23
4.3.2	Compressor	23
4.3.3	EXV	24
4.3.4	Variable VR	24
4.4	Active Setpoint	24
4.5	Evaporator LWT	24
4.6	Condenser LWT	24
4.7	Unit Capacity	24
4.8	Unit Mode	25
4.9	Unit Enable (A/C Units only)	25
4.10	Timers	25
4.11	Alarms	25
4.12	Commission Unit	26
4.12.1	Alarm Limits	26
4.12.2	Calibrate Sensors	26
4.12.2.1	Unit Calibrate Sensors	26
4.12.2.2	Circuit Calibrate Sensors	27
4.12.3	Manual Control	27
4.12.3.1	Unit	27
4.12.3.2	Circuit #1 (Circuit #2 if present)	28
4.12.4	Scheduled Maintenance	28
4.13	Software Options (Only for MicroTech™ 4)	29
4.13.1	Changing the Password for buying new Software Options	29
4.13.2	Inserting the Password in a Spare Controller	30
4.14	Energy Monitoring (Optional for MicroTech™ 4)	31
4.15	About this Chiller	31
<b>5</b>	<b>WORKING WITH THIS UNIT</b>	<b>32</b>
5.1	Unit Setup	32
5.1.1	Control Source	32
5.1.2	Available Mode Setting	32
5.1.3	Temperature Settings	33
5.1.3.1	LWT Setpoint Setting	33
5.1.3.2	Thermostat Control Settings	33
5.1.4	Alarm Settings	34
5.1.4.1	Pumps	35
5.1.5	Power Conservation	35
5.1.5.1	Demand Limit	35
5.1.5.2	Current Limit (Optional)	35
5.1.5.3	Setpoint Reset	36
5.1.5.4	Setpoint Reset by External 4-20 mA Signal	36
5.1.5.5	Setpoint Reset by Evaporator Return Temperature	36
5.1.5.6	Soft Load	37
5.1.6	Date/Time	37
5.1.6.1	Date, Time and UTC Settings	37
5.2	Unit/Circuit Start-up	37

5.2.1	Unit Status .....	37
5.2.2	Prepare the unit to start .....	38
5.2.2.1	Unit Switch Enable .....	38
5.2.2.2	Keypad Enable .....	38
5.2.2.1	BMS Enable .....	38
5.2.3	Unit Start sequence .....	38
5.2.4	Circuit Status .....	39
5.2.5	Circuits start sequence .....	40
5.2.6	Low Evaporating Pressure .....	40
5.2.7	High Condensing Pressure .....	41
5.2.8	High Vfd Current .....	41
5.2.9	High Discharge Temperature .....	41
5.3	Condensation Control .....	42
5.4	EXV Control .....	42
5.5	Liquid Injection Control .....	43
5.6	Variable Volume Ratio Control .....	43
<b>6</b>	<b>ALARMS AND TROUBLESHOOTING .....</b>	<b>44</b>
6.1	Unit Alerts .....	44
6.1.1	Bad Current Limit Input .....	44
6.1.2	Bad Demand Limit Input .....	44
6.1.3	Bad Leaving Water Temperature Reset Input .....	45
6.1.4	Condenser Pump #1 Failure (W/C units only) .....	45
6.1.5	Condenser Pump #2 Failure (W/C units only) .....	45
6.1.6	Energy Meter Communication Fail .....	46
6.1.7	Evaporator Pump #1 Failure .....	46
6.1.8	Evaporator Pump #2 Failure .....	46
6.1.9	External Event .....	47
6.1.10	Rapid Recovery Module Communication Fail .....	47
6.2	Unit Pumpdown Stop Alarms .....	47
6.2.1	Condenser Entering Water Temperature (EWT) sensor fault .....	47
6.2.2	Condenser Leaving Water Temperature (LWT) sensor fault .....	48
6.2.3	Evaporator Entering Water Temperature (EWT) sensor fault .....	48
6.2.4	Evaporator Water Temperatures inverted .....	48
6.3	Unit Rapid Stop Alarms .....	49
6.3.1	Condenser Water Freeze alarm .....	49
6.3.2	Condenser Water Flow Loss alarm .....	49
6.3.3	Emergency Stop .....	49
6.3.4	Evaporator Flow Loss alarm .....	50
6.3.5	Evaporator Leaving Water Temperature (LWT) sensor fault .....	50
6.3.6	Evaporator Water Freeze alarm .....	50
6.3.7	External alarm .....	51
6.3.8	Gas Leakage Alarm .....	51
6.4	Circuit Events .....	52
6.4.1	Low Evaporator Pressure Hold/Unload .....	52
6.4.2	High Condenser Pressure Hold/Unload .....	52
6.4.3	High Pressure Thermostatic Off .....	53
6.4.4	Failed Pumpdown .....	53
6.5	Circuit Pumpdown Stop Alarms .....	53
6.5.1	Discharge Temperature Sensor fault .....	53
6.5.2	Liquid Temperature Sensor fault .....	54
6.5.3	Low Oil Level fault .....	54
6.5.4	Low Discharge Superheat fault .....	54
6.5.5	Oil Pressure Sensor fault .....	55
6.5.6	Suction Temperature Sensor fault .....	55

6.6	Circuit Rapid Stop Alarms .....	55
6.6.1	Compressor Extension Communication Error .....	55
6.6.2	EXV Driver Extension Communication Error .....	56
6.6.3	Compressor VFD Fault.....	56
6.6.4	Condensing Pressure sensor fault .....	56
6.6.5	Evaporating Pressure sensor fault .....	57
6.6.6	Motor Temperature Sensor Fault .....	57
6.6.7	EXV Driver Error .....	57
6.6.8	High Discharge Temperature Alarm .....	58
6.6.9	High Motor Current Alarm.....	58
6.6.10	High Motor Temperature Alarm .....	58
6.6.11	High Oil Pressure Differential Alarm.....	59
6.6.12	High Pressure alarm .....	59
6.6.13	Low Pressure alarm.....	60
6.6.14	Low Pressure Ratio Alarm.....	60
6.6.15	Mechanical High Pressure Alarm .....	61
6.6.16	No Pressure At Start Alarm .....	61
6.6.17	No Pressure Change At Start Alarm .....	61
6.6.18	Overvoltage Alarm .....	62
6.6.19	Undervoltage Alarm .....	62
6.6.20	Motor Phase Loss.....	62
6.6.21	Motor Earth Leakage .....	63
6.6.22	VFD Mains Input Phase Loss .....	63
6.6.23	VFD Control Card Temperature High .....	63
6.6.24	VFD Communication Failure .....	64
<b>7</b>	<b>OPTIONS.....</b>	<b>65</b>
7.1	Energy Meter including Current Limit (Optional).....	65
7.2	Rapid Restart (Optional) .....	65

# 1 SAFETY CONSIDERATIONS

---

## 1.1 General

Installation, start-up and servicing of equipment can be hazardous if certain factors particular to the installation are not considered: operating pressures, presence of electrical components and voltages and the installation site (elevated plinths and built-up up structures). Only properly qualified installation engineers and highly qualified installers and technicians, fully trained for the product, are authorized to install and start-up the equipment safely.

During all servicing operations, all instructions and recommendations, which appear in the installation and service instructions for the product, as well as on tags and labels fixed to the equipment and components and accompanying parts supplied separately, must be read, understood and followed.

Apply all standard safety codes and practices.

Wear safety glasses and gloves.

Use the proper tools to move heavy objects. Move units carefully and set them down gently.

## 1.2 Avoid electrocution

Only personnel qualified in accordance with IEC (International Electrotechnical Commission) recommendations may be permitted access to electrical components. It is particularly recommended that all sources of electricity to the unit be shut off before any work is begun. Shut off main power supply at the main circuit breaker or isolator.

**IMPORTANT: This equipment uses and emits electromagnetic signals. Tests have shown that the equipment conforms to all applicable codes with respect to electromagnetic compatibility.**



**RISK OF ELECTROCUTION:** Even when the main circuit breaker or isolator is switched off, certain circuits may still be energized, since they may be connected to a separate power source.



**RISK OF BURNS:** Electrical currents cause components to get hot either temporarily or permanently. Handle power cable, electrical cables and conduits, terminal box covers and motor frames with great care.



**ATTENTION:** In accordance with the operating conditions the fans can be cleaned periodically. A fan can start at any time, even if the unit has been shut down.

---

## 1.3 Safety Devices

Each unit is equipped with safety devices of three different kinds:

### 1.3.1 General safety devices

Safeties of this level of severity will shut down all the circuits and stop the entire unit. When a general safety device will occur a manual intervention on the unit will be required in order to re-establish the normal operability of the machine. There are exceptions to this general rule in case of alarms linked to temporary abnormal conditions.

- Emergency Stop

A push button is placed on a door of the unit electrical panel. The button is highlighted by a red color in yellow background. A manual pressure of the emergency stop button stops all loads from rotating, thus preventing any accident which may occur. An alarm is also generated by the Unit Controller. Releasing the emergency stop button enables the unit, which may be restarted only after the alarm has been cleared on the controller.



**The emergency stop causes all motors to stop, but does not switch off power to the unit. Do not service or operate on the unit without having switched off the main switch.**

---

### 1.3.2 Circuit safety devices

Safety of this level of severity will shut down the circuit they protect. The remaining circuits will keep running.

### 1.3.3 Component safety devices

Safety of this level of severity will shut down a component against abnormal running condition that could create permanent damages to it. An overview of the protecting devices is listed below:

- Overcurrent/Overload Protections

Overcurrent/overload devices protect electrical motors used on compressors, fans and pumps in case of overload or short circuit. In case of inverter-driven motors, overload and overcurrent protection is integrated in the electronic drives. A further protection from short circuit is accomplished by fuses or circuit breakers installed upstream each load or group of loads.

- Overtemperature Protections

Compressor and fan electrical motors are also protected from overheating by thermistors immersed into motor windings. Should the winding temperature exceed a fixed threshold, the thermistors will trip and cause the motor to stop. High Temperature Alarm is recorded in the Unit Controller only in case of compressors. Alarm must be reset from the controller.



***Do not operate on a faulty fan before the main switch has been shut off. Overtemperature protection is auto-reset, therefore a fan may restart automatically if temperature conditions allow it.***

---

- Phase reversal, under/over voltage, ground fault protections

When one of those alarms occurs the unit is immediately stopped or even inhibited to start. The alarms clear automatically once the problem is fixed. This auto clear logic allows the unit to automatically recover in case of temporary conditions where the supply voltage reaches the upper or lower limit set on the protection device. In the other two cases a manual intervention on the unit will be required in order to solve the problem. In case of a phase reversal alarm two phases requires to be inverted.

In the event of a power supply outage, the unit will restart automatically without the need for an external command. However, any faults active when the supply is interrupted are saved and may in certain cases prevent a circuit or unit from restarting.



***Direct intervention on the power supply can cause electrocution, burns or even death. This action must be performed only by trained persons.***

---

- Flowswitch

The unit must be protected by a flowswitch. The flowswitch will stop the unit when the water flow becomes lower than the minimum allowed flow. When the water flow is restored the flow protection resets automatically. Exception is when the flowswitch opens with at least one compressor running, in this case the alarm shall be cleared manually.

- Freezing protection

Antifreeze protection prevents the water to freeze in the evaporator. It is automatically activated when the water temperature (entering or leaving) at the evaporator drops below the antifreeze limit. In freeze condition if the unit is in standby the evaporator pump will be activated to prevent freezing of the evaporator. If the freeze condition will activate when the unit is running all the unit will shut down in alarm while the pump will keep running. Alarm will automatically clear when the freeze condition will clear.

- Low pressure protection

If the circuit operates with a suction pressure lower than an adjustable limit for a certain time the circuit safety logic will shut down the circuit and generate an alarm. The alarm requires a manual action on the Unit Controller to be reset. Reset will take effect only if the suction pressure is no longer lower than the safety limit.

- High Pressure Protection

If the discharge pressure becomes too high and exceeds a limit which is linked with the operational envelop of the compressor the circuit safety logic will try to prevent the alarm or, if the corrective actions have no effect, it will shut down the circuit before the Mechanical High Pressure switch will open. This alarm required a manual action on the Unit Controller to be reset.

- Mechanical High Pressure Switch

Each circuit is equipped with at least one high pressure switch which tries to prevent the relief safety valve to open. When the discharge pressure becomes too high the Mechanical High Pressure switch will open and immediately stop the compressor cutting the power supply to the auxiliary relay. The alarm can be cleared as soon as the discharge pressure becomes normal again. The alarm must be reset on the switch itself and on the Unit Controller. The triggering pressure value cannot be changed.

- Relief Safety Valve

If the pressure becomes too high in the refrigerant circuit, the relief valve will open to limit the maximum pressure. If this happens switch off immediately the machine and contact your local service organization.

- Inverter fault

Each compressor can be equipped with its own inverter (integrated or external). The inverter can automatically monitor its status and inform the Unit Controller in case of faults or pre-alarm conditions. If this happen the Unit Controller will limit the

compressor operation or eventually switch off the circuit in alarm. A manual action on the controller will be needed in order to clear the alarm.

## 1.4 Available sensors

### 1.4.1 Pressure transducers

Two types of electronic sensors are used to measure suction, discharge and oil pressure on each circuit. The range of each sensor is clearly indicated on the sensor casing. Discharge and oil pressures are monitored using a sensor of the same range.

### 1.4.2 Temperature sensors

The evaporator water sensors are installed in the entering and leaving side. An outdoor temperature sensor is mounted inside the chiller. Additionally each circuit installs a suction and discharge temperature sensors to monitor and control the superheated refrigerant temperatures.

On refrigerant-cooled inverters additional sensors immersed into the cooling plate measure the temperature of the drives.

### 1.4.3 Thermistors

Each compressor is equipped with PTC thermistors which are immersed into motor windings for motor protection. Thermistors trip to a high value in case the motor temperature reaches a hazardous temperature.

### 1.4.4 Leak detectors

As an option the unit can be equipped with leak detectors to sense the air in the compressor cabin and being able to identify a refrigerant leakage in that volume.

## 1.5 Available Controls

### 1.5.1 Evaporator pumps

The controller can regulate one or two evaporator pumps and takes care of automatic change-over between pumps. It's also possible to prioritize the pumps and temporarily disable one of the two. The controller is also able to control the pump speeds if the pumps are equipped with inverters.

### 1.5.2 Condenser pumps (W/C units only)

The controller can regulate one or two condenser pumps and takes care of automatic change-over between pumps. It's also possible to prioritize the pumps and temporarily disable one of the two.

### 1.5.3 Compressors

The controller can regulate one or two compressors installed on one or two independent refrigerant circuit (one compressor per circuit). All the safeties of each compressor will be managed by the controller. Embedded inverter safeties are handled by the inverter onboard electronic and only notified to the UC.

### 1.5.4 Expansion Valve

The controller can regulate an electronic expansion valve per each refrigerant circuit. MicroTech™ embedded logic will always guarantee the best operation for the refrigerant circuit.

### 1.5.5 Evaporator Flow Switch

Although the flow switch is offered as an optional, it is mandatory to install one and connect it to the digital input terminals in order to enable chiller operation only when a minimum flow is sensed.



***Operating the unit by-passing the flow switch input or without an appropriate flow switch may damage the evaporator due to freezing. Operation of the flow switch must be checked prior to start up the unit.***

---

### 1.5.6 Condenser Flow Switch

Condenser flow switch is offered as an option but it's not mandatory to connect it to the digital input terminals. This input can be eventually closed by a jumper even if for a more reliable use it's suggested to mount it. If not installed, other protection will activate in order to protect the unit.



### **1.5.7 Evaporator Three Way Valve (Optional)**

Evaporator Three Way valve is offered as an option but it is not mandatory to connect to the analog output terminals. This output control can be enabled if a three way valve is connected to the evaporator. This option can be enabled in commission unit menu.

### **1.5.8 Double setpoint**

This contact can be used to switch between two different LWT setpoints and, depending on the application, between different modes of operation.

Ice operation must be selected in case of ice storage application. In this case the UC will run the chiller in on/off mode, switching all the chiller off as soon as the setpoint is reached. In this case the unit will run to full capacity and then will switch off applying an ice delay different chiller starts.

### **1.5.9 Current limit (optional)**

This optional feature enables a capacity control of the unit in order to limit the input current. The current limit feature is included in the Energy Meter option. The limiting signal will be compared with a limiting value set on the HMI. By default the current limit setpoint is selected through the HMI; an external 4-20 mA signal can be enabled to allow a remotely changeable setpoint.

### **1.5.10 External Fault**

This contact is available to report to the UC a fault or a warning from an external device. It could be an alarm coming from an external pump to inform the UC of the fault. This input can be configured as a fault (unit stop) or a warning (displayed on the HMI without any action on the chiller).

### **1.5.11 Rapid Restart (optional)**

Purpose of the rapid restart feature is to let the unit restart in the shortest possible time after a power failure, and then recover in the shortest possible time (maintaining the reliability level of the normal operations) the capacity it had before the power failure. The rapid restart is enabled by the enable switch.

### **1.5.12 Remote On-Off**

This unit can be started through a remote enable contact. The Q0 switch must be selected to "Remote".

### **1.5.13 General Alarm**

In case of a unit alarm, this output is closed thus indicating a fault condition to an externally connected BMS.

### **1.5.14 Compressor Status**

The digital output is closed when the related circuit is in run state.

### **1.5.15 Circuit Alarm (optional)**

This option is included with the "Rapid Restart" option. The related digital contact is closed in case of alarm on a circuit.

### **1.5.16 Evaporator Pump Start**

A 24 Vdc digital output (with internal supply) is enabled when a pump (#1 or #2) is required to start. The output can be used to start an external pump (either at fixed or variable speed). The output requires an external input or relay with less than 20 mA excitation current.

### **1.5.17 Condenser Pump Start (W/C units only)**

A digital output is enabled when a pump (#1 or #2) is required to start. A pump will be required to start when a compressor will be called to start.

### **1.5.18 Demand limit**

This optional function can be used to limit the unit capacity percentage to a changeable limit value. This limitation cannot be directly linked to a corresponding limitation of the unit current (50% demand limit can differ from 50% of the unit FLA).

The demand limit signal can be changed continuously between 4 and 20 mA. The MicroTech™ will convert this signal into a unit capacity limitation changing between minimum capacity and full capacity with a linear relationship. A signal between 0 and 4mA will correspond to a full unit capacity, in this way if nothing is connected to this input no limitation will be applied. The maximum limitation will never force a unit shutdown.

### **1.5.19 Setpoint override**

This input allows to apply an offset on the Active Setpoint to adjust the operating point of the ELWT. This input can be used to maximize the comfort.

## 2 GENERAL DESCRIPTION

---

### 2.1 Basic Information

MicroTech™ is a system for controlling single or dual-circuit air/water-cooled liquid chillers. MicroTech™ controls compressor start-up necessary to maintain the desired heat exchanger leaving water temperature. In each unit mode it controls the operation of the condensers to maintain the proper condensation process in each circuit.

Safety devices are constantly monitored by MicroTech™ to ensure their safe operation. MicroTech™ also gives access to a Test routine covering all inputs and outputs. All MicroTech™ controls can work in accordance with three independent modes:

- Local mode: the machine is controlled by commands from the user interface.
- Remote mode: the machine is controlled by remote contacts (volt-free contacts).
- Network mode: the machine is controlled by commands from a BAS system. In this case, a data communication cable is used to connect the unit to the BAS.

When the MicroTech™ system operates autonomously (Local or Remote mode) it retains all of its own control capabilities but does not offer any of the features of the Network mode. In this case monitoring of the unit operational data is still allowed.

### 2.2 Abbreviations used

In this manual, the refrigeration circuits are called circuit #1 and circuit #2. The compressor in circuit #1 is labelled Cmp1. The other in circuit #2 is labelled Cmp2. The following abbreviations are used:

<b>A/C</b>	Air Cooled
<b>CEWT</b>	Condenser Entering Water Temperature
<b>CLWT</b>	Condenser Leaving Water Temperature
<b>CP</b>	Condensing Pressure
<b>CSRT</b>	Condensing Saturated Refrigerant Temperature
<b>DSH</b>	Discharge Superheat
<b>DT</b>	Discharge Temperature
<b>E/M</b>	Energy Meter Module
<b>EEWT</b>	Evaporator Entering Water Temperature
<b>ELWT</b>	Evaporator Leaving Water Temperature
<b>EP</b>	Evaporating Pressure
<b>ESRT</b>	Evaporating Saturated Refrigerant Temperature
<b>EXV</b>	Electronic Expansion Valve
<b>HMI</b>	Human Machine Interface
<b>MOP</b>	Maximum operating pressure
<b>SSH</b>	Suction SuperHeat
<b>ST</b>	Suction Temperature
<b>UC</b>	Unit controller (MicroTech™)
<b>W/C</b>	Water Cooled

### 2.3 Controller Operating Limits

Operation (IEC 721-3-3):

- Temperature -40...+70 °C
- Restriction LCD -20... +60 °C
- Restriction Process-Bus -25...+70 °C
- Humidity < 90 % r.h (no condensation)
- Air pressure min. 700 hPa, corresponding to max. 3,000 m above sea level

Transport (IEC 721-3-2):

- Temperature -40...+70 °C
- Humidity < 95 % r.h (no condensation)
- Air pressure min. 260 hPa, corresponding to max. 10,000 m above sea level.

### 2.4 Controller Architecture

The overall controller architecture is the following:

- One MicroTech™ main controller
- I/O extensions as needed depending on the configuration of the unit
- Communications interface(s) as selected
- Peripheral Bus is used to connect I/O extensions to the main controller.

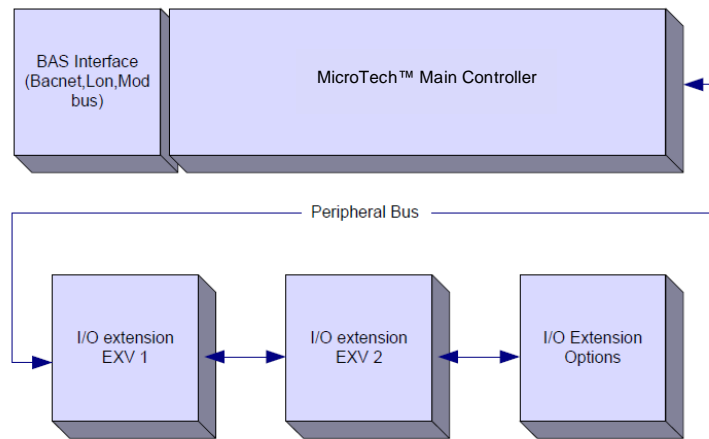

Controller/ Extension Module	Siemens Part Number			Address	Usage
	EWAD TZ	EWAD/H TZ B	EWWD/H-VZ		
Main Controller	POL687.70/MCQ	POL687.70/MCQ	POL687.00/MCQ	n/a	Used on all configurations
Extension Module	-	-	POL965.00/MCQ	2	Used on all configurations
EEXV Module 1	POL94U.00/MCQ	POL98U.00/MCQ	POL94U.00/MCQ	3	Used on all configurations
EEXV Module 2	POL94U.00/MCQ	POL98U.00/MCQ	-	4	Used when configured for 2 circuits
Extension Module	-	-	POL965.00/MCQ	4	Used when configured for 2 circuits
EEXV Module 2	-	-	POL94U.00/MCQ	5	Used when configured for 2 circuits
Extension Module	POL965.00/MCQ	-	-	5	Used on all configurations
Rapid Restart Module	POL945.00/MCQ	-	POL945.00/MCQ	22	Used with Rapid Restart option

All boards are supplied from a common 24 Vac source. Extension boards can be directly powered by the Unit Controller. All boards can be also supplied by a 24Vdc source.



**CAUTION:** Maintain the correct polarity when connecting the power supply to the boards, otherwise the peripheral bus communication will not operate and the boards may be damaged.

## 2.5 Communication Modules

Any of the following modules can be connected directly to the left side of the main controller to allow a BAS or other remote interface to function. Up to three can be connected to the controller at a time. The controller should automatically detect and configure itself for new modules after booting up. Removing modules from the unit will require manually changing the configuration.

Module	Siemens Part Number	Usage
BacNet/IP	POL908.00/MCQ	Optional
Lon	POL906.00/MCQ	Optional
Modbus	POL902.00/MCQ	Optional
BACnet/MSTP	POL904.00/MCQ	Optional

### 3 USING THE CONTROLLER

The control system consists of a unit controller (UC) equipped with a set of extension modules that implement additional features. All boards communicate via an internal peripheral bus with the UC. The MicroTech™ continuously manages the information received from the various pressure and temperature probes installed on the compressors and communicated to the unit. The UC incorporates a program that controls the unit.

The standard HMI consists of an inbuilt display (A) with 3 buttons (B) and a push'n'roll control (C).

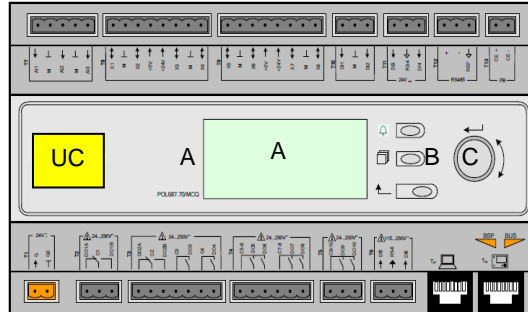

The keypad/display (A) consists of a 5-line by 22 character display. The function of the three buttons (B) is described below:

	Alarm status (from any page it links with the page with alarm list, alarm log and alarm snapshot if available)
	Back to Main Page
	Back to the previous level (it can be the Main Page)

The push'n'roll command (C) is used to scroll between the different menu pages, settings and data available on the HMI for the active password level. Rotating the wheel allows to navigate between lines on a screen (page) and to increase and decrease changeable values when editing. Pushing the wheel acts as an Enter Button and will jump from a link to the next set of parameters.

#### 3.1 General Recommendation

Before switching on the unit read the following recommendations:

- When all the operations and all the settings have been carried out, close all the switchbox panels
- The switchbox panels can only be opened by trained personnel
- When the UC requires to be accessed frequently the installation of a remote interface is strongly recommended
- Evaporator, compressors and related inverters are protected from freezing by electrical heaters. These heaters are supplied through unit main supply and temperature controlled by thermostat or by the unit controller. Also the LCD display of the unit controller may be damaged by extremely low temperatures. For this reason, it is strongly recommended to never power off the unit during winter, especially in cold climates.

#### 3.2 Navigating

When power is applied to the control circuit, the controller screen will be active and display the Home screen, which can also be accessed by pressing the Menu Button. The navigating wheel is the only navigating device necessary, although the MENU, ALARM, and BACK buttons can provide shortcuts as explained previously.

An example of the HMI screens is shown in the following picture.

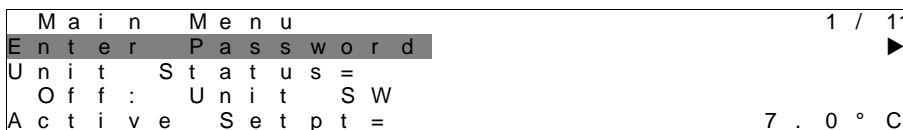

A bell ringing in the top right corner will indicate an active alarm. If the bell doesn't move it means that the alarm has been acknowledged but not cleared because the alarm condition hasn't been removed. A LED will also indicate where the alarm is located between the unit or circuits.

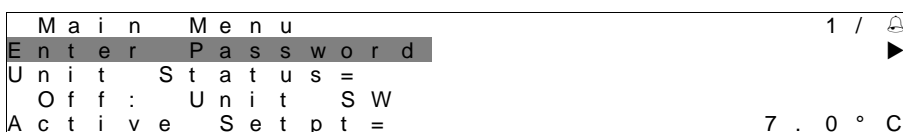

The active item is highlighted in contrast, in this example the item highlighted in Main Menu is a link to another page. By pressing the push'n'roll, the HMI will jump to a different page. In this case the HMI will jump to the Enter Password page.

E n t e r P a s s w o r d	2 / 2
E n t e r P W	* * * *

### 3.3 Passwords

The HMI structure is based on access levels that means that each password will disclose all the settings and parameters allowed to that password level. Basic informations about the status including the active alarm list, active setpoint and controlled water temperature can be accessed without the need to enter the password. The user UC handles two level of passwords:

USER	5321
MAINTENANCE	2526

The following information will cover all data and settings accessible with the maintenance password. User password will disclose a subset of the settings explained in chapter 4.

In the Enter Password screen, the line with the password field will be highlighted to indicate that the field on the right can be changed. This represents a setpoint for the controller. Pressing the push'n'roll the individual field will be highlighted to allow an easy introduction of the numeric password. By changing all fields, the 4 digits password will be entered and, if correct, the additional settings available with that password level will be disclosed.

E n t e r P a s s w o r d	2 / 2
E n t e r P W	5 * * *

The password will time out after 10 minutes and is cancelled if a new password is entered or the control powers down. Entering an invalid password has the same effect as continuing without a password.

Once a valid password has been entered, the controller allows further changes and access without requiring the user to enter a password until either the password timer expires or a different password is entered. The default value for this password timer is 10 minutes. It is changeable from 3 to 30 minutes via the Timer Settings menu in the Extended Menus.

### 3.4 Editing

The Editing Mode is entered by pressing the navigation wheel while the cursor is pointing to a line containing an editable field. Once in the edit mode pressing the wheel again causes the editable field to be highlighted. Turning the wheel clockwise while the editable field is highlighted causes the value to be increased. Turning the wheel counter-clockwise while the editable field is highlighted causes the value to be decreased. The faster the wheel is turned, the faster the value is increased or decreased. Pressing the wheel again cause the new value to be saved and the keypad/display to leave the edit mode and return to the navigation mode.

A parameter with an "R" is read only; it is giving a value or description of a condition. An "R/W" indicates a read and/or write opportunity; a value can be read or changed (providing the proper password has been entered).

**Example 1:** Check Status, for example -is the unit being controlled locally or by an external network? We are looking for the Unit Control Source. Since this a unit status parameter, start at Main Menu and select View/Set Unit and press the wheel to jump to the next set of menus. There will be an arrow at the right side of the box, indicating that a jump to the next level is required. Press the wheel to execute the jump. You will arrive at the Status/ Settings link. There is an arrow indicating that this line is a link to a further menu. Press the wheel again to jump to the next menu, Unit Status/Settings. Rotate the wheel to scroll down to Control Source and read the result.

**Example 2:** Change a Set point, the chilled water set point for example. This parameter is designated as Cool LWT Set point 1 and is a unit set parameter. From the Main Menu select View/Set Unit. The arrow indicated that this is link to a further menu. Press the wheel and jump to the next menu View/Set Unit and use the wheel to scroll down to Temperatures. This again has an arrow and is a link to a further menu. Press the wheel and jump to the Temperatures menu, which contains six lines of temperatures set points. Scroll down to Cool LWT 1 and press the wheel to jump to the item change page. Rotate the wheel to adjust the set point to the desired value. When this is done press the wheel again to confirm the new value. With the Back button it will be possible to jump back to the Temperatures menu where the new value will be displayed.

**Example 3:** Clear an Alarm. The presence of a new alarm is indicated with a Bell ringing on the top right of the display. If the Bell is frozen one or more alarm had been acknowledged but are still active. To view the Alarm menu from the Main Menu scroll down to the Alarms line or simply press the Alarm button on the display. Note the arrow indicating this line is a link. Press the wheel to jump to the next menu Alarms; there are two lines here: Alarm Active and Alarm Log. Alarms are cleared from the Active Alarm link. Press the wheel to jump to the next screen. When the Active Alarm list is entered scroll to the item AlmClr which is set to off by default. Change this value to on to acknowledge the alarms. If the alarms can be cleared then the alarm counter will display 0 otherwise it will display the number of alarm still active. When the alarms are

acknowledged the Bell on the top right of the display will stop to ring if some of the alarms are still active or will disappear if all the alarms are cleared.

### 3.5 Basic Control System Diagnostic

MicroTech™ controller, extension modules and communication modules are equipped with two status LED (BSP and BUS) to indicate the operational status of the devices. The BUS LED indicates the status of the communication with the controller. The meaning of the two status LED is indicated below.

#### Main Controller (UC)

BSP LED	Mode
Solid Green	Application running
Solid Yellow	Application loaded but not running (*) or BSP Upgrade mode active
Solid Red	Hardware Error (*)
Flashing Green	BSP startup phase. The controller needs time for starting.
Flashing Yellow	Application not loaded (*)
Flashing Yellow/Red	Fail safe mode (in case that the BSP upgrade was interrupted)
Flashing Red	BSP Error (software error*)
Flashing Red/Green	Application/BSP update or initialization

(\*) Contact Service.

#### Extension modules

BSP LED	Mode	BUS LED	Mode
Solid Green	BSP running	Solid Green	Communication running, I/O working
Solid Red	Hardware Error (*)	Solid Red	Communication down (*)
Flashing Red	BSP Error (*)	Solid Yellow	Communication running but parameter from the application wrong or missing, or uncorrect factory calibration
Flashing Red/Green	BSP upgrade mode		

#### Communication modules

##### BSP LED (same for all modules)

BSP LED	Mode
Solid Green	BPS running, communication with controller
Solid Yellow	BSP running, no communication with controller (*)
Solid Red	Hardware Error (*)
Flashing Red	BSP Error (*)
Flashing Red/Green	Application/BSP update

(\*) Contact Service.

##### BUS LED

BUS LED	LON	Bacnet MSTP	Bacnet IP	Modbus
Solid Green	Ready for Communication. (All Parameter loaded, Neuron configured). Doesn't indicate a communication with other devices.	Ready for Communication. The BACnet Server is started. It doesn't indicate an active communication	Ready for Communication. The BACnet Server is started. It doesn't indicate an active communication	All Communication running
Solid Yellow	Startup	Startup	Startup. The LED stays yellow until the module receives a IP Address, therefore a link must be established.	Startup, or one configured channel not communicating to the Master
Solid Red	No Communication to Neuron (internal error, could be solved by downloading a new LON application)	BACnet Server down. Automatically a restart after 3 seconds are initiated.	BACnet Server down. Automatic restart after 3 seconds is initiated.	All configured Communications down. Means no communication to the Master. The timeout can be configured. In case that the timeout is zero the timeout is disabled.
Flashing Yellow	Communication not possible to the Neuron. The Neuron must be configured and set online over the LON Tool.			

### 3.6 Controller maintenance

The controller requires to maintain the installed battery. Every two years it's required to replace the battery. Battery model is: BR2032 and it is produced by many different vendors.

To replace the battery remove the plastic cover of the controller display using a screw driver as shown in the following pictures:

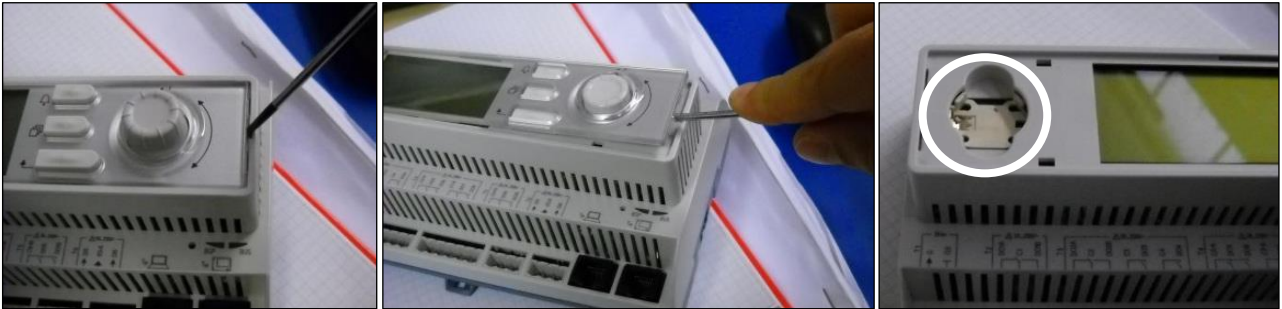

Be careful to avoid damages to the plastic cover. The new battery shall be placed in the proper battery holder which is highlighted in the picture, respecting the polarities indicated into the holder itself.

### 3.7 Optional Remote User Interface

As an option an external Remote HMI can be connected on the UC. The Remote HMI offers the same features as the inbuilt display plus the alarm indication done with a light emitting diode located below the bell button.

The Remote can be ordered with the unit and shipped loose as a field installed option. It can also be ordered any time after chiller shipment and mounted and wired on the job as explained on the following page. The remote panel is powered from the unit and no additional power supply is required.

All viewing and setpoint adjustments available on the unit controller are available on the remote panel. Navigation is identical to the unit controller as described in this manual.

The initial screen when the remote is turned on shows the units connected to it. Highlight the desired unit and press the wheel to access it. The remote will automatically show the units attached to it, no initial entry is required.

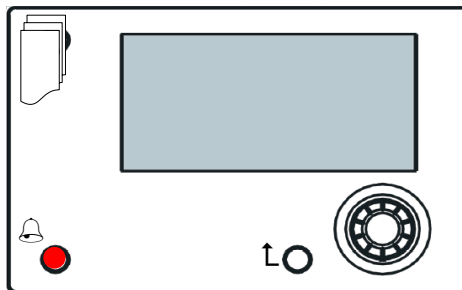

The Remote HMI can be extended up to 700m using the process bus connection available on the UC. With a daisy-chain connection as below, a single HMI can be connected to up to 8 units. Refer to the specific HMI manual for details.

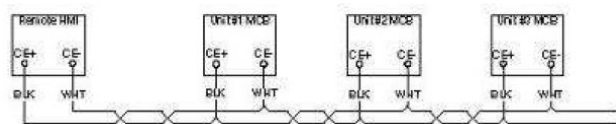



### 3.8 Embedded Web Interface

The MicroTech™ controller has an embedded web interface that can be used to monitor the unit when connected to a local network. It is possible to configure the IP addressing of the MicroTech™ as a fixed IP or DHCP depending on the network configuration.

With a common web browser a PC can connect with the unit controller entering the IP address of the controller or the host name, both visible in the “About Chiller” page accessible without entering a password.

When connected, it will be required to enter a user name and a password. Enter the following credential to get access to the web interface:

User Name: Daikin

Password: Daikin@Web

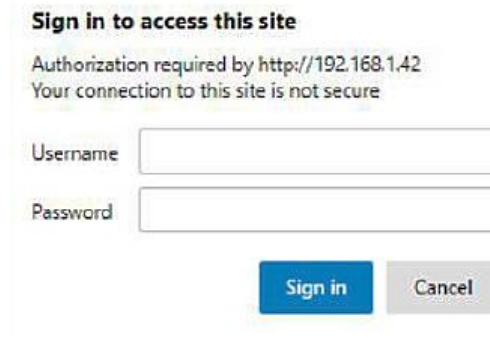

The Main Menu page will be displayed. The page is a copy of the onboard HMI and follows the same rules in terms of access levels and structure.

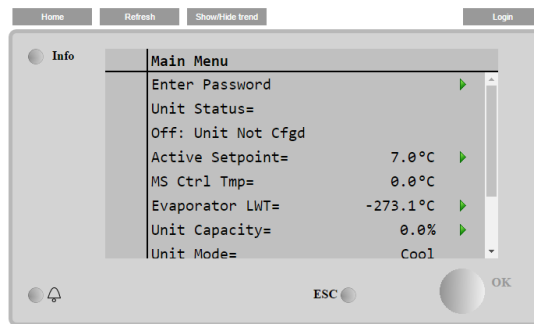

In addition it allows to trend log a maximum of 5 different quantities. It's required to click on the value of the quantity to monitor and the following additional screen will become visible:

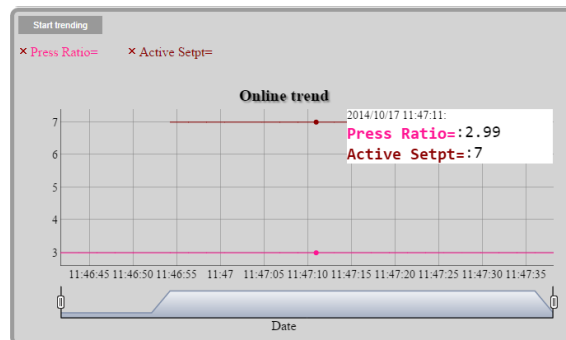

Depending on the web browser and its version the trend log feature may not be visible. It's required a web browser supporting HTML 5 like for example:

- Microsoft Internet Explorer v.11,
- Google Chrome v.37,
- Mozilla Firefox v.32.

These software are only an example of the browser supported and the versions indicated have to be intended as minimum versions.

## 4 MENU STRUCTURE

All settings are divided in different menus. Each menu collects in a single page other sub-menus, settings or data related to a specific function (for example Power Conservation or Setup) or entity (for example Unit or Circuit). In any of the following pages, a grey box will indicate changeable values and the defaults.

### 4.1 Main Menu

Setpoint/Sub-Menu	Default	Range	Description
Enter Password	▶	-	Submenu to activate access levels
View/Set Unit	▶	-	Submenu for unit data and settings
View/Set Circuit	▶	-	Submenu for circuit data and settings
Unit Status=	Off: Unit Sw	Auto Off: Ice Mode Tmr Off: OAT Lockout (A/C units only) Off: All Cir Disabled Off: Unit Alarm Off: Keypad Disable Off: Master Disable Off: BAS Disable Off: Unit Sw Off: Test Mode Off: Schedule Disable Auto: Noise Reduction Auto: Wait For Load Auto: Evap Recirc (A/C units only) Auto: Water Recir (W/C units only) Auto: Wait For Flow Auto: Pumpdn Auto: Max Pulldn Auto: Unit Cap Limit Auto: Current Limit	Status of the Unit
Active Setpoint=	7.0°C, ▶	-	Water temperature active setpoint + link to Setpoint page
MS Ctrl Tmp=	-273.1°C, ▶	-	Master slave controlled temperature + link to Master Slave Data page
Evaporator LWT=	-273.1°C, ▶	-	Evaporator leaving water temperature + link to Temperatures page
Condenser LWT=	-273.1°C, ▶	-	Condenser leaving water temperature + link to Temperatures page (W/C units only)
Unit Capacity=	0.0%, ▶	-	Unit capacity + link to Capacity page
Unit Mode=	Cool, ▶	-	Unit Mode + link to Available modes page
Unit Enable=	Enable, ▶	-	Unit Enable state + link to unit and circuits enable page
Timers	▶	-	Submenu for unit timers
Alarms	▶	-	Submenu for alarms; same function as Bell Button
Commission Unit	▶	-	Submenu for commission unit
About Chiller	▶	-	Application Info submenu

### 4.2 View/Set Unit

Setpoint/Sub-Menu	Default	Range	Description
Thermostat Ctrl	▶	-	Submenu for Thermostatic control
Network Ctrl	▶	-	Submenu for Network control
Vfd Settings	▶	-	Submenu Vfd installation settings (A/C units only)
Pumps	▶	-	Submenu for pump settings
Condenser	▶	-	Submenu for Condenser tower control (W/C units Only)
Master/Slave	▶	-	Submenu for Master Slave data and settings
Rapid Restart	▶	-	Submenu for Rapid Restart Option
Date/Time	▶	-	Submenu Date, Time and Quiet Night mode schedule
Scheduler	▶	-	Submenu for Time Scheduler
Power Conservation	▶	-	Submenu Unit Limiting functions
Electrical Data	▶	-	Submenu for electrical data
Ctrl IP Setup	▶	-	Submenu for controller IP-address setup
Daikin on Site	▶	-	Submenu for connection to Daikin cloud DoS
Menu Password	▶	-	Submenu Disable Password for User level

#### 4.2.1 Thermostat Ctrl

This page resumes all the parameters related to the unit thermostatic control.

Setpoint/Sub-Menu	Default	Range	Description
	VZ		
Start Up DT=	2.7°C	0.0...5.0°C	Offset to start thermostat control
Shut Dn DT=	1.5°C	0.0...1.7°C	Offset to standby
Stg Up DT=	0.5°C	0.0...1.7°C	Offset to allow compressor starts
Stg Dn DT=	0.7°C	0.0...1.7°C	Offset to force one compressor off
Stg Up Delay=	3 min	0...60 min	Compressor start interstage
Stg Dn Delay=	3 min	3...30 min	Compressor stop interstage
Strt Strt Dly=	15min	15...60 min	Compressor Start to Start delay
Stop Strt Dly=	3min	3...20 min	Compressor Stop to Start delay
Ice Cycle Dly=	12h	1...23h	Ice cycle delay
Lt Ld Stg Dn %=	20%	20...50%	Circuit capacity threshold to stage down one compressor
Hi Ld Stg Up %=	50%	50...100%	Circuit capacity threshold to stage up one compressor
Max Ckts Run=	2	1...2	Limit to the number of circuit to be used
C1 Sequence #=	1	1...2	Manual sequence of circuit #1
C2 Sequence #=	1	1...2	Manual sequence of circuit #2
Next Crkt On=	0	-	Shows next circuit to be started up
Next Crkt Off=	0	-	Shows next circuit number to be stopped

#### 4.2.2 Network Ctrl

This page resumes all settings related to Network control.

Setpoint/Sub-Menu	Default	Range	Description
	VZ		
Control Source=	Local	Local, Network	Control source selection: Local/BMS
Act Ctrl Src=	N/A	Local, Network	Active control between Local/BMS
Netwrk En SP=	Disable	Enable, Disable	Enable unit command from BMS
Netwrk Mode SP=	Cool	-	Cool, Ice, Heat (NA), Cool/Heat Recovery
Netwrk Cool SP=	6.7°C	-	Cooling setpoint from BMS
Netwrk Cap Lim=	100%	-	Capacity limitation from BMS
Netwrk HR SP=	N/A	-	Heat recovery setpoint from BMS
Network Heat SP=	45.0°C	-	Heating setpoint from BMS
Netwrk Ice SP=	-4.0°C	-	Ice setpoint from BMS
Netwrk Current SP=	800A	-	Setpoint for current limitation from BMS
Remote Srv En=	Disable	Enable, Disable	Remote server enable

#### 4.2.3 Pumps

This page contains the settings to define the operation of the primary/backup pumps, the running hours of each pump and all parameters to configure the behavior of the pump driven with an inverter.

Setpoint/Sub-Menu	Default	Range	Description
	VZ		
Evp Pmp Ctrl=	#1 Only	#1 Only, #2 Only, Auto, #1 Primary, #2 Primary	Set number of Evaporator pumps operational and which priority.
Evap Recirc Tm=	30s	0...300s	Water recirculating timer
Evap Pmp 1 Hrs=	0h		Running Hours Evaporator Pump 1 (if present)
Evap Pmp 2 Hrs=	0h		Running Hours Evaporator Pump 2 (if present)
Cnd Pump Ctrl=	#1 Only	#1 Only, #2 Only, Auto, #1 Primary, #2 Primary	Set number of Condenser pumps operational and which priority.
Cond Pmp 1 Hrs=	0h		Running Hours Condenser Pump 1 (if present)
Cond Pmp 2 Hrs=	0h		Running Hours Condenser Pump 2 (if present)

#### 4.2.4 Condenser

This page contains basics settings for condensation control described in section 5.3.

Setpoint/Sub-Menu	Default	Range	Description
Cond LWT	-273.1°C	-	Present value of Condenser Leaving Water Temperature
Cond EWT	-273.1°C	-	Present value of Condenser Entering Water Temperature
Cond Target	25.0 °C	19.0...55.0 °C	Target for Condenser Leaving Water Temperature
Cond Fan Spd	0.0%	0.0...100.0%	Present value of Condenser Fan Speed
Tower Setpt 1	25.0 °C	19.0...55.0 °C	Setpoint for activation of Tower 1
Tower Setpt 2	27.0 °C	26.0...55.0 °C	Setpoint for activation of Tower 2
Tower Setpt 3	29.0 °C	28.0...55.0 °C	Setpoint for activation of Tower 3
Tower Setpt 4	31.0 °C	30.0...55.0 °C	Setpoint for activation of Tower 4
Tower Diff 1	1.5 °C	0.1...5.0 °C	Differential for deactivation of Tower 1
Tower Diff 2	1.5 °C	0.1...5.0 °C	Differential for deactivation of Tower 1
Tower Diff 3	1.5 °C	0.1...5.0 °C	Differential for deactivation of Tower 1
Tower Diff 4	1.5 °C	0.1...5.0 °C	Differential for deactivation of Tower 1
Min Vfd Sp	10.0%	0.0...49.0 %	Setpoint for minimum percentage of Vfd Speed
Max Vfs Sp	100.0%	55.0...100.0%	Setpoint for maximum percentage of Vfd Speed
PID Prop Gain	10.0	0.0...50.0	Proportional Gain of PID condensation controller
PID Der Time	1s	0...180s	Derivative Time of PID condensation controller
PID Int Time	600s	0...600s	Integral Time of PID condensation controller
Vfd Manual Speed	20.0%	0.0...100.0%	Setpoint for Vfd manual speed

#### 4.2.5 Evaporator

This page contains basics settings for evaporator three way valve control (Optional).

Setpoint/Sub-Menu	Default	Range	Description
Cool Setp Offs	1.5°C	1.0...7.0°C	Offset on the cool setpoint to regulate the three way valve
Valve Type	NC to Tower	NC to tower, NO to Tower	Type of three way valve to tower
Min Valve Open	0.0%	0.0...60.0%	Valve minimum position
Max Valve Open	95.0%	50.0...100.0%	Valve maximum position
Kp	1	0.1...100	Proportional Gain of PID valve controller
Ti	2.0min	1.0...60.0min	Derivative Time of PID valve controller
Td	2.0min	1.0...60.0min	Integral Time of PID valve controller

#### 4.2.6 Rapid Restart

This page shows if the function Rapid Restart is enabled by external contact and it allows to define the maximum black out time in order to recover quickly the unit load.

Setpoint/Sub-Menu	Default	Range	Description
Rapid Restart=	Disable	Enable, Disable	Feature enable if Rapid Restart is installed
Pwr Off Time=	60s	-	Maximum black out time to enable Rapid Restart

#### 4.2.7 Date/Time

This page will allow to adjust the time and date in the UC. This time and date will be used in the alarm log and to enable and disable the Quiet Mode. Additionally it's also possible to set the starting and ending date for the DayLight Saving time (DLS) if used. Quiet Mode is a feature that is used to reduce the chiller noise. This is done by applying the maximum setpoint reset to the cooling setpoint and increasing the condenser temperature target by an adjustable offset.

Setpoint/Sub-Menu	Default	Range	Description
	VZ		
Actual Time=	12:00:00		Set the time
Actual Date=	01/01/2014		Set the date
UTC Diff=	-60min		Difference with UTC
DLS Enable=	Yes	No, Yes	Enable DayLight Saving time
DLS Strt Month=	Mar		DayLight Saving time start month
DLS Strt Week=	2ndWeek		DayLight Saving time start week
DLS End Month=	Nov	NA, Jan...Dec	DayLight Saving time end month
DLS End Week=	1stWeek	1 <sup>st</sup> ...5 <sup>th</sup> week	DayLight Saving time end week
Quiet Mode=	N/A	Disable, Enable	Activate Quiet Mode
QM Start Hr=	N/A	18...23h	Quiet Mode start hour
QM Start Min=	N/A	0...59min	Quiet Mode start minute
QM End Hr=	N/A	5...9h	Quiet Mode end hour
QM End Min=	N/A	0...59min	Quiet Mode end minute
QM Cond Offset=	N/A	0.0...14.0°C	Quiet Mode condenser target offset

On board real time clock settings are maintained thanks to a battery mounted on the controller. Make sure that the battery is replaced regularly each 2 years (see section 3.6).

#### 4.2.8 Scheduler

Unit On/Off can be managed automatically through the function Time Scheduler enabled when the parameter Unit Enable is set to Scheduler. For each day of the week user can define six time slots and choose for each time slot one of following mode:

Parameter	Description
Off	Unit Off
On Setpoint 1	Unit On and Cool LWT 1 is the active setpoint
On Setpoint 2	Unit On and Cool LWT 2 is the active setpoint

This page allows to program the time scheduler.

Setpoint/Sub-Menu	Default	Range	Description
State	Off	Off, On Setpoint 1, On Setpoint 2	Actual state provided by the time scheduler
Monday	▶	-	Link to Monday scheduler programming page
Tuesday	▶	-	Link to Tuesday scheduler programming page
Wednesday	▶	-	Link to Wednesday scheduler programming page
Thursday	▶	-	Link to Thursday scheduler programming page
Friday	▶	-	Link to Friday scheduler programming page
Saturday	▶	-	Link to Saturday scheduler programming page
Sunday	▶	-	Link to Sunday scheduler programming page

Table below reports the menu used to program daily time slots. Six time slots can be programmed by the user.

Setpoint/Sub-Menu	Default	Range	Description
Time 1	*. *	0:00..23:59	Define the starting time of 1 <sup>st</sup> time slot
Value 1	Off	Off, On Setpoint 1, On Setpoint 2	Define the unit state during 1 <sup>st</sup> time slot
Time 2	*. *	0:00..23:59	Define the starting time of 2 <sup>nd</sup> time slot
Value 2	Off	Off, On Setpoint 1, On Setpoint 2	Define the unit state during 2 <sup>nd</sup> time slot
Time 3	*. *	0:00..23:59	Define the starting time of 3 <sup>rd</sup> time slot
Value 3	Off	Off, On Setpoint 1, On Setpoint 2	Define the unit state during 3 <sup>rd</sup> time slot
Time 4	*. *	0:00..23:59	Define the starting time of 4 <sup>th</sup> time slot
Value 4	Off	Off, On Setpoint 1, On Setpoint 2	Define the unit state during 4 <sup>th</sup> time slot
Time 5	*. *	0:00..23:59	Define the starting time of 5 <sup>th</sup> time slot
Value 5	Off	Off, On Setpoint 1, On Setpoint 2	Define the unit state during 5 <sup>th</sup> time slot
Time 6	*. *	0:00..23:59	Define the starting time of 6 <sup>th</sup> time slot
Value 6	Off	Off, On Setpoint 1, On Setpoint 2	Define the unit state during 6 <sup>th</sup> time slot

#### 4.2.9 Power Conservation

This page resumes all the settings that allows chiller capacity limitations. Further explanations of the setpoint reset options can be found in the chapter 7.1.

Setpoint/Sub-Menu	Default	Range	Description
Unit Capacity=	100.0%		
Demand Lim En=	Disable	Disable, Enable	Demand Limit Enable
Demand Limit=	100.0%		Demand Limit Mode - Active demand limitation
Unit Current=	E/M Only		Current Limit Mode (optional) - Unit current reading
Current Limit=	800A		Current Limit Mode (optional) - Active Current limit
Flex Current Lm=	Disable	Disable, Enable	Flexible Current Limit Enable
Current Lim Sp=	800A	0...2000A	Current Limit Mode (optional) - Current limit setpoint
Setpoint Reset=	None	None, 4-20mA, Return, OAT	Setpoint Reset Type (OAT reset)
Max Reset=	5.0°C	0.0...10.0°C	Setpoint Reset Mode - Max Reset of water temp. setpoint
Start Reset DT=	5.0°C	0.0...10.0°C	Setpoint Reset Mode - Evaporator DT at which no reset is applied
Max Reset OAT=	N/A	10.0...29.4°C	Setpoint Reset Mode - OAT at which the max reset is applied
Strt Reset OAT=	N/A	10.0...29.4°C	Setpoint Reset Mode - OAT at which 0°C reset is applied
Softload En=	Disable	Disable, Enable	Soft Load Mode Enable
Softload Ramp=	20min	1...60min	Soft Load Mode - Duration of the Softload ramp
Starting Cap=	40.0%	20.0...100.0%	Soft Load Mode - Starting capacity limit for Softload

#### 4.2.10 Controller IP setup

The MicroTech™ controller has an embedded web server showing a replica of the onboard HMI screens. To access to this additional web HMI can be required to adjust the IP settings to match the settings of the local network. This can be done in this page. Please contact your IT department for further information on how to set the following setpoints.

To activate the new settings a reboot of the controller is required, this can be done with the Apply Changes setpoint.

The controller also supports DHCP, in this case the name of the controller must be used.

Setpoint/Sub-Menu	Default	Range	Description
Apply Changes=	No	No, Yes	When Yes, it save changes made on settings and reboot the controller
DHCP=	Off	Off, On	When On, Enable DHCP to automatically obtain an IP address
Act IP=	-		Active IP address
Act Msk=	-		Active Subnet mask
Act Gwy=	-		Active Gateway
Gvn IP=	-		Given IP address (it will become the active)
Gvn Msk=	-		Given Subnet mask
Gvn Gwy=	-		Given Gateway
PrimDNS	-		Primary DNS
SecDNS	-		Secondary DNS
Name	-		Controller Name
MAC	-		Controller MAC Address

Check with IT Department on how to set these properties in order to connect the MicroTech™ to the local network.

#### 4.2.11 Daikin on Site

This menu allows to the user to enable the communication with Daikin cloud DoS (Daikin on Site). This option requires that the controller has access to internet. Please contact your service organization for more details.

Setpoint/Sub-Menu	Default	Range	Description
Comm Start=	Off	Off, Start	Command to enable the communication
Comm State=	-	- IPErr Init InitReg Reg RegErr Descr Connected	Communication state. The communication is established only if this parameter displays Connected
Cntrlr ID=	-	-	Controller ID. This parameter is helpful to identify the specific controller in DoS
Remote Update=	Disable	Disable, Enable	Allow the application update from Daikin on Site.

#### 4.3 View/Set Circuit

In this section it is possible to select between the available circuits and access data available for the circuit selected.

Setpoint/Sub-Menu	Default	Range	Description
Circuit #1	▶		Menu for Circuit #1
Circuit #2	▶		Menu for Circuit #2

The submenus accessed for each circuit are identical but the content of each of them reflects the status of the corresponding circuit. In the following the submenus will be explained only once. If only one circuit is available the item Circuit #2 in the above table will be hidden and not accessible.

Each of the above links will jump to the following submenu:

Setpoint/Sub-Menu	Default	Description
Data	▶	Thermodynamic data
Compressor	▶	Status of the compressor and electrical data
EXV	▶	Status of the expansion valve regulation
Settings	▶	Settings

In any of the above submenus each item shows a value and a link to another page. In that page the same data will be represented for both circuits as a reference as shown in the below example.

Setpoint/Sub-Menu	Default	Description
Comp 1 Run Hours	-	Indication of the data represented
Circuit #1=	0h	Data related to Circuit #1
Circuit #2=	0h	Data related to Circuit #2

### 4.3.1 Data

In this page all relevant thermodynamic data are displayed.

Setpoint/Sub-Menu	Default	Range	Description
Circuit Status=			Status of the circuit
Off:VFD Heating			Off: Ready Off: Stage Up Delay Off: Cycle Timer Off: BAS Disable Off: Keypad Disable Off: Circuit Switch Off: Oil Heating Off: Alarm Off: Test Mode EXV Preopen Run: Pumpdown Run: Normal Run: Disch SH Low Run: Evap Press Low Run: Cond Press High Run: High LWT Limit Run: High VFD Amps Run: High VFD Temp Off: Max Comp Starts Off: VFD Heating Off: Maintenance
Capacity=	0.0%		Circuit capacity
Evap Pressure=	220.0kPa		Evaporating Pressure
Cond Pressure=	1000.0kPa		Condensing Pressure
Suction Temp=	5.0°C		Suction Temperature
Discharge Temp=	45.0°C		Discharge Temperature
Suction SH=	5.0°C		Suction Superheat
Discharge SH=	23.0°C		Discharge Superheat
Oil Pressure=	1000.0kPa		Oil Pressure
Oil Pr Diff=	0.0kPa		Oil Pressure differential
EXV Position=	50%		Expansion valve position
Liq Inj=	Off		Liquid Injection status
Variable VR St=	Off(VR2)		VR2 or VR3 slide position status
Evap LWT=	7.0°C		Evaporator LWT
Evap EWT=	12.0°C		Evaporator EWT

### 4.3.2 Compressor

This page resumes all the relevant information about compressor. In this page a manual adjustment of the compressor capacity will be possible.

Setpoint/Sub-Menu	Default	Range	Description
	VZ	VZ	
Start=			Date and time of the last start
Stop=			Date and time of the last stop
Run Hours=	0h		Running hours of compressor
No. Of Starts=	0		Number of compressor starts
Cycle Time Rem=	0s		Remaining cycle time left
Clear Cycle Time	Off		Cycle time clear command
Capacity=	100%		Compressor capacity
Act Speed=	N/A		Compressor speed (depends on model)
Feedback Cap	0.0%		
Current=	N/A		Inverter current
Percent RLA=	N/A		Percentage over the Full Load current
Power Input=	N/A		Power Input
DC Voltage	N/A		DC-Link Voltage
Cap Control=	Auto	Auto, ManStep, ManSpd	Capacity Control Mode
Manual Cap=	0.0%		Manual capacity percentage
VFD Temp=	N/A		VFD Temperature
Vfd Valve Life=	N/A		Inverter cooling SV remaining cycles
Vfd Capct Life=	N/A		Inverter capacitors remaining life
Start VFD Spd=	N/A		Compressor start speed
Max VFD Spd=	N/A		Compressor maximum speed

### 4.3.3 EXV

This page resumes all the relevant information about the status of the EXV logic.

Setpoint/Sub-Menu	Default	Range	Description
	VZ		
EXV State=	Closed	Closed, Pressure, Superheat	EXV State
Suction SH=	6.0°C		Suction Superheat
Superht Target=	6.0°C		Suction Superheat setpoint
Press Target	-		
Evap Pressure=	220kPa		Evaporating Pressure
EXV Position=	50.0%		Expansion valve opening

### 4.3.4 Variable VR

This page contains present data of variable VR control.

Setpoint/Sub-Menu	Description
Press Ratio	Present value of compressor pressure ratio
VR Position	Present position of VR slide

### 4.4 Active Setpoint

This link jumps to the page "Tmp Setpoint". This page resumes all chiller water temperature setpoints (limits and active setpoint will depend on the operating mode selected).

Setpoint/Sub-Menu	Default	Range	Description
	VZ		
Cool LWT 1=	7.0°C	4.0...15.0°C (cool mode) -8.0...15.0°C (cool w/ glycol mode)	Primary cooling setpoint
Cool LWT 2=	7.0°C	4.0...15.0°C (cool mode) -8.0...15.0°C (cool w/ glycol mode)	Secondary cooling setpoint (see 3.6.3)
Ice LWT=	-4.0°C	-8.0...4.0°C	Ice setpoint (ice banking with on/off mode)
Max LWT=	15.0°C	10.0...20.0°C	High limit for Cool LWT1 and Cool LWT2
Min LWT=	-8.0°C	-15.0...-8.0°C	Low limit for Cool LWT1 and Cool LWT2

### 4.5 Evaporator LWT

This link jumps to the page "Temperatures". This page resumes all the relevant water temperatures.

Setpoint/Sub-Menu	Default	Range	Description
	VZ		
Evap LWT=	-273.1°C	-	Controlled water temperature
Evap EWT=	-273.1°C	-	Return water temperature
Cond LWT=	-273.1°C	-	Condenser leaving water temperature
Cond EWT=	-273.1°C	-	Condenser entering water temperature
Evap Delta T=	-273.1°C	-	Delta T across Evaporator
Cond Delta T=	-273.1°C	-	Delta T across Condenser
Pulldn Rate	N/A	-	Rate of decrease of the controlled temperature
Ev LWT Slope	0.0°C/min	-	Rate of decrease of the controlled temperature
Cd LWT Slope	0.0°C/min	-	Rate of decrease of the condenser leaving water temperature
Outside Air=	N/A	-	Outside air temperature
Act Slope Lim.	1.7 °C/min		Maximum slopes

### 4.6 Condenser LWT

This link jumps to the page "Temperatures". See section 4.5 for detailed page content.

### 4.7 Unit Capacity

This page displays the actual unit and circuit capacity.

Setpoint/Sub-Menu	Default	Range	Description
Unit=	-	-	Actual unit capacity
Circuit #1=	-	-	Actual circuit 1 capacity
Circuit #2=	-	-	Actual circuit 2 capacity



## 4.8 Unit Mode

This item shows the present Operating Mode and jumps to the page for unit mode selection.

Setpoint/Sub-Menu	Default	Range	Description
		VZ	
Available Modes=	Cool	Cool, Cool w/ Glycol, Cool/Ice w/ Glycol, Ice w/ Glycol, Heat/Cool, Heat/Cool w/Glycol, Heat/Ice w/Glycol, Pursuit, Test	Available operating modes

Depending on selected mode among availables, the Unit Mode on the main menu will assume the corresponding value according to the following table:

Available mode selected	Operating Mode	
	VZ	
	C/H Switch = Cool	C/H Switch = Heat
Cool	Cool	N/A
Cool w/ Glycol		
Cool/Ice w/ Glycol		
Ice w/ Glycol	Ice	Heat
Heat/Cool	Cool	
Heat/Cool w/Glycol		
Heat/Ice w/Glycol	Ice	
Pursuit	Pursuit	
Test	Test	

## 4.9 Unit Enable (A/C Units only)

This page allows to enable or disable unit and circuits. For the unit it also possible enable the operation with time scheduler, while for circuit it is possible to enable the test mode.

Setpoint/Sub-Menu	Default	Range	Description
Unit	Enable	Enable, Disable, Scheduler	Unit enable command
Circuit #1	Enable	Enable, Disable, Test	Circuit #1 enable command
Circuit #2	Enable	Enable, Disable, Test	Circuit #2 enable command

## 4.10 Timers

This page indicates the remaining cycle timers for each circuit and the remaining staging timers. When the cycle timers are active any new start of a compressor is inhibited.

Setpoint/Sub-Menu	Default	Range	Description
C1 Cycle Tm Left=	0s	-	Circuit 1 cycle timer
C2 Cycle Tm Left=	0s	-	Circuit 2 cycle timer
C1 Cycle Tmr Clr=	Off	Off, On	Clear circuit 1 cycle timer
C2 Cycle Tmr Clr=	Off	Off, On	Clear circuit 2 cycle timer
Stg Up Dly Rem=	0s	-	Remaining delay to next compressor start
Stg Dn Dly Rem=	0s	-	Remaining delay to next compressor stop
Clr Stg Delays=	Off	Off, On	Clear remaining delays to next compressor start/stop
Ice Cycle Rem=	0min	-	Remaining Ice cycle delay
Clr Ice Dly	Off	Off, On	Clear remaining delay for Ice mode

## 4.11 Alarms

This link jumps to the same page accessible with the Bell button. Each of the items represents a link to a page with different information. The information shown depends on the abnormal operating condition that caused the activation of unit, circuit or compressor safeties. A detailed description of the alarms and how to handle will be discussed in the section 6.

Setpoint/Sub-Menu	Default	Description
Alarm Active	▶	List of the active alarms
Alarm Log	▶	History of all the alarms and acknowledges
Event Log	▶	List of the events
Alarm Snapshot	▶	List of alarm snapshots with all the relevant data recorded at time the alarm occurred.

## 4.12 Commission Unit

Setpoint/Sub-Menu	Default	Range	Description
Alarms Limits	▶	-	Submenu for alarm limits definition
Calibrate Sensors	▶	-	Submenus for Unit and Circuit sensor calibration
Manual Control	▶	-	Submenus for Unit and Circuit manual control
Scheduled Maintenance	▶	-	Submenu for scheduled maintenance

### 4.12.1 Alarm Limits

This page contains all alarm limits, including low pressure alarm prevention thresholds. In order to ensure proper operation they have to be set manually according to the specific application.

Setpoint/Sub-Menu	Default VZ	Range	Description
Low Press Hold=	200.0kPa	0...310.0 kPa	Low pressure safety limit to stop capacity increase (R134a)
Low Press Unld=	190.0kPa	0...250.0 kPa	Low pressure alarm prevention (R134a)
Low Press Hold=	122.0kPa	-27.0...204.0 kPa	Low pressure safety limit to stop capacity increase (R1234ze)
Low Press Unld=	114.0kPa	-27.0...159.0 kPa	Low pressure alarm prevention (R1234ze)
Low Press Hold=	225.0	0.0... 250.0	Low pressure safety limit to stop capacity increase (R513A)
Low Press Unld=	235.0	0.0... 310.0	Low pressure alarm prevention (R513A)
Hi Oil Pr Dly=	30s	10...180s	Delay for the High oil pressure difference alarm
Hi Oil Pr Diff=	250kPa	0.0...415.0kPa	Pressure drop for a clogged filter
Hi Disch Temp=	110.0°C		Maximum discharge temperature limit
Hi Cond Pr Dly=	5s		Delay on the High pressure alarm from transducer
Lo Pr Ratio Dly=	90s		Delay on the low pressure ratio alarm
OAT Lockout=	4.0°C		Air temperature operational limit
Strt Time Lim=	N/A		Time limit for the low ambient start
Evap Flw Proof=	N/A		Flow proof delay
Evp Rec Timeout=	N/A		Recirculating timeout before the alarm is raised
Evap Water Frz=	2.2°C	-18.0...6.0 °C	Freeze protection limit
Water Flw Proof=	15s	5...15s	Flow proof delay
Water Rec Timeout=	3min	1...10min	Recirculating timeout before the alarm is raised
Low DSH Limit=	12.0°C		Minimum acceptable discharge superheat
Gas Conc Lim=	200ppm		Maximum gas concentration limit
HP Sw Test C#1	Off		On, Off. Enables to check operation of the high pressure switch on #1.
HP Sw Test C#2	Off		On, Off. Enables to check operation of the high pressure switch on #2.
Ext Fault Cfg=	N/A	Event, Alarm	Definition of the unit behavior after switching of external alarm contact



**The HP Sw Test shuts off all fans while compressor is running in order to raise condenser pressure until tripping of the high pressure switches. Beware that in case of high pressure switch failure the safety valves will trip and hot refrigerant will be ejected at high pressure!**



**Once tripped, the software will get back to normal operation. However, the alarm will not be reset until the high pressure switches are manually reset through the button included in the switch.**

### 4.12.2 Calibrate Sensors

Setpoint/Sub-Menu	Default	Range	Description
Unit	▶	-	Submenu for Unit calibrate sensor
Circuit #1	▶	-	Submenu for Circuit 1 calibrate sensor
Circuit #2	▶	-	Submenu for Circuit 2 calibrate sensor

#### 4.12.2.1 Unit Calibrate Sensors

This page allows a proper calibration of the unit sensors.

Setpoint/Sub-Menu	Default	Range	Description
Evap LWT=	7.0°C		Evaporator LWT current reading (includes the offset)
Evp LWT Offset=	0.0°C		Evaporator LWT calibration
Evap EWT=	12.0°C		Evaporator EWT current reading (includes the offset)
Evp EWT Offset=	0.0°C		Evaporator EWT calibration
Outside Air=	35.0°C		Outside Air Temperature current reading (includes the offset)
OAT Offset=	0.0°C		Outside Air Temperature calibration

#### 4.12.2.2 Circuit Calibrate Sensors

This page allows to adjust the sensors and transducers readings.

Setpoint/Sub-Menu	Default	Range	Description
Evap Pressure=			Evaporator Pressure current reading (includes the offset)
Evp Pr Offset=	0.0kPa		Evaporator Pressure offset
Cond Pressure=			Condenser Pressure current reading (includes the offset)
Cnd Pr Offset=	0.0kPa		Condenser Pressure offset
Oil Pressure=			Oil Pressure current reading (includes the offset)
Oil Pr Offset=	0.0kPa		Oil Pressure offset
Suction Temp=			Suction Temperature current reading (includes the offset)
Suction Offset=	0.0°C		Suction Temperature offset
Discharge Temp=			Discharge Temperature current reading (includes the offset)
Disch Offset=	0.0°C		Discharge Temperature offset



**Calibrations of the Evaporator Pressure and Suction Temperature are mandatory for the applications with negative water temperature setpoints. These calibrations have to be performed with proper gauge and thermometer.**

**An improper calibration of the two instruments may generate limitation of the operations, alarms and even damages to components.**

#### 4.12.3 Manual Control

This page contains links to other sub-pages where all the actuators can be tested, the raw values of the readings of each sensor or transducer can be checked, the status of all the digital inputs verified and the status of all the digital output checked.

Setpoint/Sub-Menu	Default	Range	Description
Unit	▶		Actuators and sensors for the common parts (Unit)
Circuit #1	▶		Actuators and sensors for Circuit #1
Circuit #2	▶		Actuators and sensors for Circuit #2

##### 4.12.3.1 Unit

This page contains all the test point, status of the digital inputs, status of the digital output and raw value of the analog inputs associated to the Unit. To activate the test point it's required to set the Available Modes to Test (see section 4.8) and this requires the Unit to be disabled.

Setpoint/Sub-Menu	Default	Range	Description
Test Unit Alarm Out=	Off	Off/On	Test of the General Alarm relay output
Test C1 Alarm Out=	Off	Off/On	Test of the Circuit #1 Alarm relay output
Test C2 Alarm Out=	Off	Off/On	Test of the Circuit #2 Alarm relay output
Test Evap Pump 1=	Off	Off/On	Test of the Evaporator Pump #1
Test Evap Pump 2=	Off	Off/On	Test of the Evaporator Pump #2
Input/Output Values		Off/On	
Unit Sw Inpt=	Off	Off/On	Status of the Unit Switch
Estop Inpt=	Off	Off/On	Status of the Emergency Stop button
PVM Inpt=	Off	Off/On	Status of Phase Voltage monitor, Under-Over voltage protection or Ground Fault protection (check option installed)
Evap Flow Inpt=	Off	Off/On	Status of the Evaporator Flow switch
Ext Alm Inpt=	Off	Off/On	Status of the External Alarm input
CurrLm En Inpt=	Off	Off/On	Status of the Current Limit enable switch (optional)
Dbl Spt Inpt=	Off	Off/On	Status of the Double Setpoint switch
RR Unlock Inpt=	Off	Off/On	Status of the Rapid Restart enable switch (optional)
Loc Bas Inpt=	Off	Off/On	Status of the Local Network Switch input
Battery Inpt=	Off	Off/On	Status of the Battery Mode input
Evp LWT Res=	0Ohm	340-300kOhm	Resistance of the Evaporator LWT sensor
Evp EWT Res=	0Ohm	340-300kOhm	Resistance of the Evaporator EWT sensor
OA Temp Res=	0Ohm	340-300kOhm	Resistance of the OAT sensor
LWT Reset Curr=	0mA	3-21mA	Current input for the Setpoint Reset
Dem Lim Curr=	0mA	3-21mA	Current input for the Demand Limit
Unit Alm Outpt=	Off	Off/On	Status of the General Alarm relay
C1 Alm Outpt=	Off	Off/On	Status of the Circuit #1 Alarm relay
C2 Alm Outpt=	Off	Off/On	Status of the Circuit #2 Alarm relay
Evp Pmp1 Outpt=	Off	Off/On	Status of the Evaporator Pump #1 relay
Evp Pmp2 Outpt=	Off	Off/On	Status of the Evaporator Pump #2 relay

#### 4.12.3.2 Circuit #1 (Circuit #2 if present)

This page contains all the test point, status of the digital inputs, status of the digital output and raw value of the analog inputs associated to the Circuit #1 (or Circuit #2 if present and depending on the link followed). To activate the test point it's required to set the Available Modes to Test (see section 4.8) and this requires the Unit to be disabled.

Setpoint/Sub-Menu	Default	Range	Description
Test Liq Inj=	Off	Off/On	Test of the Liquid Injection SV
Test Var VR=	Off	Off/On	Test of VR3 slide position
Test EXV Pos=	0%	0-100%	Test of the Expansion Valve movements
<b>Input/Output Values</b>			
Cir Sw Inpt=	Off	Off/On	Status of the Circuit Enable switch
Mhp Sw Inpt=	Off	Off/On	Status of the Mechanical High Pressure switch
Gas Leak Inpt=	Off	Off/On	Status of the Gas Leak switch
Evap Pr Inpt=	0.0V	0.4-4.6V	Input voltage for the Evaporator Pressure
Cond Pr Inpt=	0.0V	0.4-4.6V	Input voltage for the Condenser Pressure
Oil Pr Inpt=	0.0V	0.4-4.6V	Input voltage for the Oil Pressure
Gas Leak Inpt=	0.0V	0.0-10.0V	Input voltage for the Gas Leak sensor
Suct Temp Res=	0.0Ohm	340-300kOhm	Resistance of the Suction Temp sensor
Disc Temp Res=	0.0Ohm	340-300kOhm	Resistance of the Discharge Temp sensor
Strtr Output=	Off	Off/On	Status of the Inverter start command
Liq Inj Output=	Off	Off/On	Status of the Liquid Line SV relay
Fan 1 Output=	Off	Off/On	Status of the Fan Output #1
Fan 2 Output=	Off	Off/On	Status of the Fan Output #2
Fan 3 Output=	Off	Off/On	Status of the Fan Output #3
Fan 4 Output=	Off	Off/On	Status of the Fan Output #4
Fan Vfd Output=	0.0V	0-10.0V	Output voltage to the fan VFD
Variable VR St	Off (VR2)	Off (VR2) /On (VR3)	Variable VR slide position (VR2, VR3)

#### 4.12.4 Scheduled Maintenance

This page may contains the contact number of the Service organization taking care of this unit and the next maintenance visit schedule.

Setpoint/Sub-Menu	Default	Range	Description
Next Maint=	Jan 2018		Schedule date for next maintenance
Support Reference=	999-999-999		Reference number or email of Service Org

### 4.13 Software Options (Only for MicroTech™ 4)

The possibility to employ a set of software options has been added to the functionality of the chiller, in according with the new MicroTech™ 4 installed on the Unit. The Software Options do not require any additional hardware and regard communication channels and the new energy functionalities.

During the commissioning the machine is delivered with the Option Set chosen by the customer; the Password inserted is permanent and depends on the Serial Machine Number and the Option Set selected.

In order to check the current Option Set:

**Main Menu→Commission Unit→Configuration→Software Options**

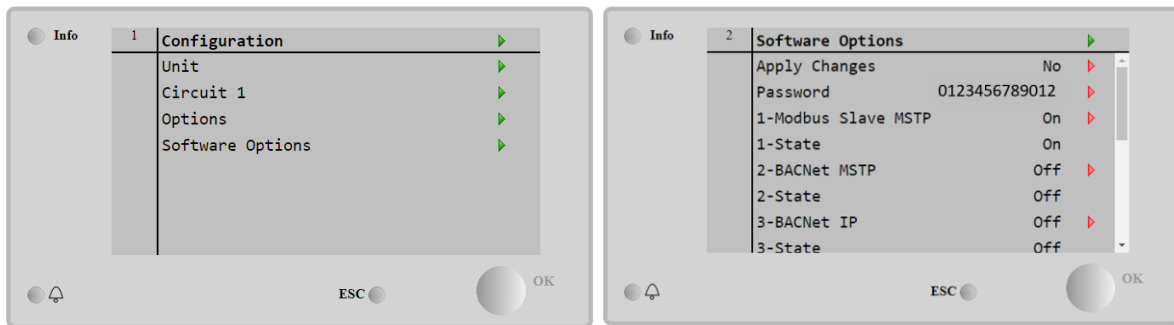

Parameter	Description
Password	Writable by Interface/Web Interface
Option Name	Option Name
Option Status	Option is activated.
	Option is not activated

The Current Password inserted activates the selected options.

#### 4.13.1 Changing the Password for buying new Software Options

The Option Set and the Password are updated in the Factory. If the customer wants to change its Option Set, he needs to contact the Daikin Personnel and asks for a new password.

As soon as the new password is communicated, the follow steps allow the customer to change the Option Set by himself:

1. Wait for the circuits are both OFF, then, from the Main Page, **Main Menu→Unit Enable→Unit→Disable**
2. Go to **Main Menu→Commission Unit→Configuration→Software Options**
3. Select the Options to Activate
4. Insert the Password
5. Wait for the States of the selected options going to On
6. Apply Changes→Yes (it will reboot the controller)



***The Password is changeable only if the machine is working in safe conditions: both the circuits are in the State Off.***

#### 4.13.2 Inserting the Password in a Spare Controller

If the Controller is broken and/or it needs to be replaced for any reason, the customer needs to configure the Option Set with a new Password.

If this replacement is scheduled, the customer can ask to Daikin Personnel for a new Password and repeat the steps in chapter 4.15.1.

If there is no enough time to ask for a Password to Daikin Personnel (ex. an expected failure of the controller), a set of Free Limited Password is provided, in order not to interrupt the machine's working.

These Passwords are free and visualized in:

#### Main Menu→Commission Unit→Configuration→Software Options→Temporary Passwords

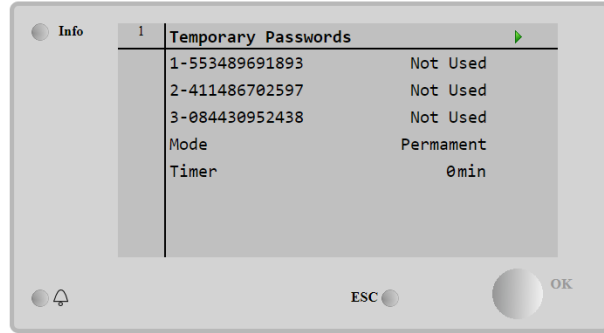
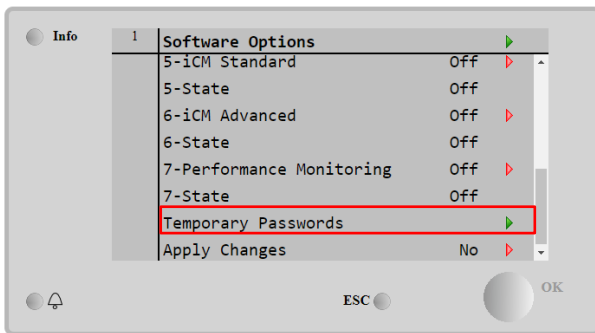

Their Use is limited up to three months:

- 553489691893 – 3 Months Duration
- 411486702597 – 1 Month Duration
- 084430952438 – 1 Month Duration

It gives the customer the time enough to contact Daikin Service and insert a new unlimited password.

Parameter	Specific Status	Description
553489691893		Activate the Option Set for 3 Months.
411486702597		Activate the Option Set for 1 Month.
084430952438		Activate the Option Set for 1 Month.
Mode	Permanent	A permanent Password is inserted. Option set can be used for unlimited time.
	Temporary	A temporary Password is inserted. Option set can be used depending on the password inserted.
Timer		Last duration of the Option Set activated. Enabled only if the mode is Temporary.



**The Password is changeable only if the machine is working in safe conditions: both the circuits are in the State Off.**

#### 4.14 Energy Monitoring (Optional for MicroTech™ 4)

The Energy Monitoring is a software option not requiring any additional hardware. It can be activated in order to achieve an estimation (5% accuracy) of the instantaneous performances of the chiller in terms of:

- Cooling Capacity
- Power Input
- Efficiency-COP

An integrated estimation of these quantities is provided. Go to the page:

**Main Menu→View / Set Unit→Energy Monitoring**

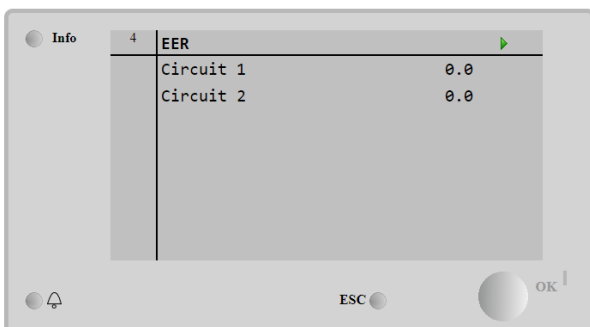
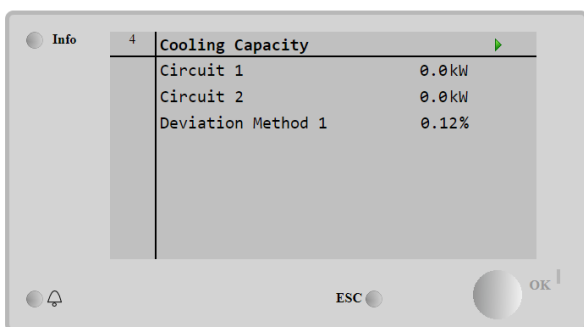
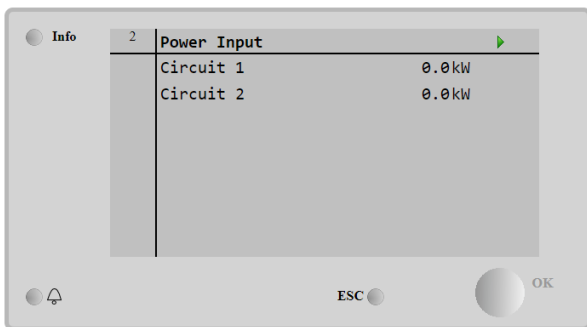
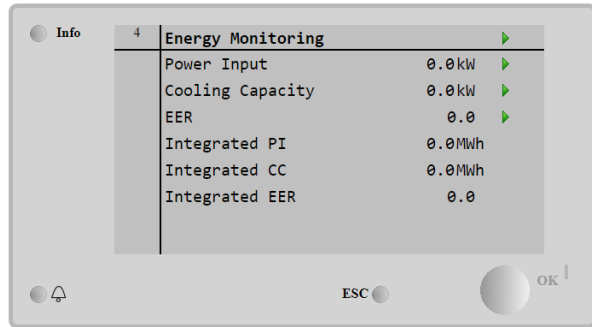
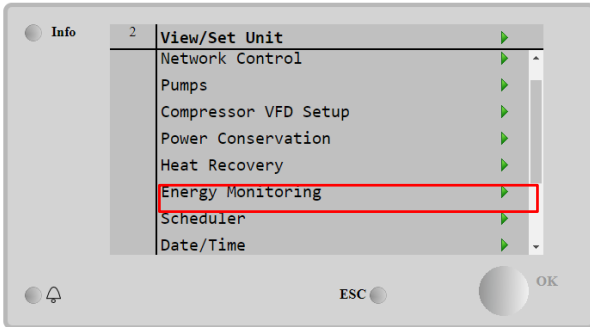

#### 4.15 About this Chiller

This page resumes all the information needed to identify the unit and the current software version installed. These information may be required in case of alarms or unit failure

Setpoint/Sub-Menu	Default	Range	Description
Model			Unit model and code name
Unit S/N=			Unit serial number
OV14-00001			
BSP Ver=			Firmware version
App Ver=			Software version

## 5 WORKING WITH THIS UNIT

This section contains a guide on how to deal with the everyday usage of the unit. Next sections describe how to perform routine tasks on the unit, such as:

- Unit Setup
- Unit/Circuit start-up
- Alarm handling
- BMS Control
- Battery replacement

### 5.1 Unit Setup

Before starting up the unit, some basic settings need to be set by the customer according to the application.

- Control Source (4.2.2)
- Available Modes (4.8)
- Temperature Settings (5.1.3)
- Alarm Settings (5.1.4)
- Pump Settings (5.1.4.1)
- Power Conservation (4.2.9)
- Date/Time (4.2.7)
- Scheduler (4.2.8)

#### 5.1.1 Control Source

This function allows to select which source should be used for unit control. The following sources are available:

Local	Unit is enabled by local switches placed into the switchbox, chiller mode (cool, cool w/glycol, ice), LWT setpoint and capacity limit are determined by local settings in the HMI.
Network	Unit is enable by a remote switch, chiller mode, LWT setpoint and capacity limit are determined by an external BMS. This function requires: Remote enable connection to a BMS (unit on/off switch must be in remote) Communication module and its connection to a BMS.

More parameters about network control can be found in 4.2.2.

#### 5.1.2 Available Mode Setting

The following operating modes can be selected through the Available modes menu 4.8:

Mode	Description	Unit Range
Cool	Set if chilled water temperature up to 4°C is required. No glycol is generally needed in the water circuit, unless ambient temperature may reach low values.	W/C
Cool w/Glycol	Set if chilled water temperature below 4°C is required. This operation requires proper glycol/water mixture in the evaporator water circuit.	W/C
Cool/Ice w/Glycol	Set in case a dual cool/ice mode is required. This setting implies an operation with double setpoint which is activated through a customer supplied switch, according to the following logic: Switch OFF: The chiller will work in cooling mode with the Cool LWT 1 being as the Active Setpoint. Switch ON: The chiller will work in ice mode with the Ice LWT as the Active Setpoint.	W/C
Ice w/Glycol	Set if ice storage is required. The application requires the compressors to operate at full load until the ice bank is completed, and then to stop for at least 12 hours. In this mode the compressor(s) will not operate at part load, but will work only in on/off mode.	W/C



**The following modes allow to switch the unit between heat mode and one of the previous cool mode (Cool, Cool w/Glycol, Ice)**

Heat/Cool	Set in case a dual cool/heat mode is required. This setting implies an operation with double functioning which is activated through the Cool/Heat switch on the electric box <ul style="list-style-type: none"> <li>• Switch COOL: The chiller will work in cooling mode with the Cool LWT 1 as the Active Setpoint.</li> <li>• Switch HEAT: The chiller will work in heat pump mode with the Heat LWT 1 as the Active Setpoint.</li> </ul>	W/C
Heat/Cool w/Glycol	Set in case a dual cool/heat mode is required. This setting implies an operation with double functioning which is activated through the Cool/Heat switch on the electric box <ul style="list-style-type: none"> <li>• Switch COOL: The chiller will work in cooling mode with the Cool LWT 1 as the Active Setpoint.</li> <li>• Switch HEAT: The chiller will work in heat pump mode with the Heat LWT 1 as the Active Setpoint</li> </ul>	W/C
Heat/Ice w/Glycol	Set in case a dual cool/heat mode is required. This setting implies an operation with double functioning which is activated through the Cool/Heat switch on the electric box <ul style="list-style-type: none"> <li>• Switch ICE: The chiller will work in cooling mode with the Ice LWT as the Active Setpoint.</li> <li>• Switch HEAT: The chiller will work in heat pump mode with the Heat LWT 1 as the Active Setpoint.</li> </ul>	W/C



Mode	Description	Unit Range
Pursuit	Set in case of double water control cool and contemporary heat. Evaporator leaving water temperature follows the Cool LWT 1 setpoint. Condenser leaving water temperature follows the Heat LWT 1 setpoint.	W/C
Test	Enables the Manual Control of the unit. The manual test feature helps in debugging and checking the operational status of sensors and actuators. This feature is accessible only with the maintenance password in the main menu. To activate the test feature is required to disable the Unit from the Q0 switch and change the available mode to Test (see section 5.2.2).	W/C

### 5.1.3 Temperature Settings

Purpose of the unit is to keep the evaporator leaving water temperature as close as possible to a pre-set value, called Active Setpoint. The Active Setpoint is calculated by the unit controller based on the following parameters:

- Available Modes
- Double setpoint input
- Scheduler state
- LWT Setpoint
- Setpoint Reset
- Quiet Mode (A/C units only)

Operation mode and LWT setpoint can also be set via network if the appropriate control source has been selected.

#### 5.1.3.1 LWT Setpoint Setting

Setpoint range is limited according to the selected operating mode. The controller includes:

- two set points in cooling mode (either standard cool or cool w/glycol)
- two set points in heating mode (W/C units only)
- one set point in ice mode

The above setpoints are activated according to Operating mode, Double Setpoint or Scheduler selection. If the Time Scheduler is enabled the Double Setpoint input state will be ignored by the controller.

The table below lists the LWT Setpoint being activated according to the operation mode, the double setpoint switch status and the scheduler state. The table also reports the defaults and the range allowed for each setpoint.

Operating Mode	Units	Double Input	Setpoint	Scheduler	LWT Setpoint	Default	Range
Cool	W/C	OFF		Off, On Setpoint 1	Cool LWT 1	7.0°C	4.0°C ÷ 15.0°C
		ON		On Setpoint 2	Cool LWT 2	7.0°C	4.0°C ÷ 15.0°C
Ice	W/C	N/A		N/A	Ice LWT	-4.0°C	-8.0°C ÷ 4.0°C
Heat	W/C	OFF		Off, On Setpoint 1	Heat LWT 1	45.0°C	30.0°C ÷ 60.0°C(*)
		ON		On Setpoint 2	Heat LWT 2	45.0°C	30.0°C ÷ 60.0°C(*)

(\*) 30.0°C ÷ 65.0 for HT unit type

The LWT setpoint can be overridden in case the setpoint reset (for details see chapter 5.1.5.3).



**Double Setpoint, Setpoint Reset and Quiet Mode are not operational in Ice Mode.**

#### 5.1.3.2 Thermostat Control Settings

Thermostat control settings, allows to set up the response to temperature variations and the precision of the thermostat control. Default settings are valid for most applications, however site specific conditions may require adjustments in order to have a smooth and precise temperature control or a quicker response of the unit.

The control will start the first circuit if the controlled temperature is higher (Cool Mode) or lower (Heat Mode) than the active setpoint (AS) of at least a Start Up DT (SU) value. Once circuit capacity exceeds the *Hi Ld Stg Up* % another circuit is switched on. When controlled temperature is within the deadband (DB) error from the active setpoint (AS), unit capacity will not be changed.

If the leaving water temperature decreases below (Cool Mode) or rises above (Heat Mode) the active setpoint (AS), unit capacity is adjusted to keep it stable. A further decreasing (Cool Mode) or increasing (Heat Mode) of the controlled temperature of the Shut Down DT offset (SD) can cause circuit shutdown.

In the Shutdown area the whole unit is switched off. In particular, a compressor will be shut down if it is required to unload below the *Lt Ld Stg Dn* % capacity.

Loading and unloading speeds are calculated by a proprietary PID algorithm. However, maximum the rate of water temperature decrease can be limited through the parameter *Max PullDn*.



Circuits are always started and stopped to guarantee the balancing of running hours and number of starts in multiple circuit units. This strategy optimizes the lifetime of compressors, inverters, capacitors and all the others circuit components.

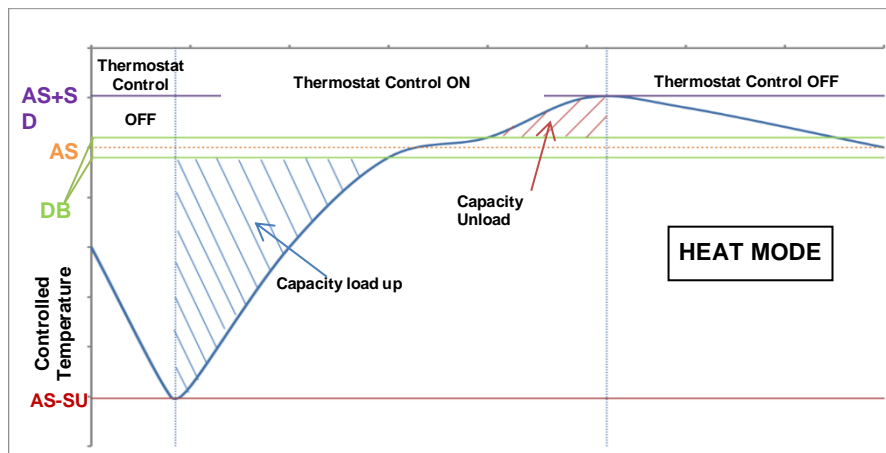
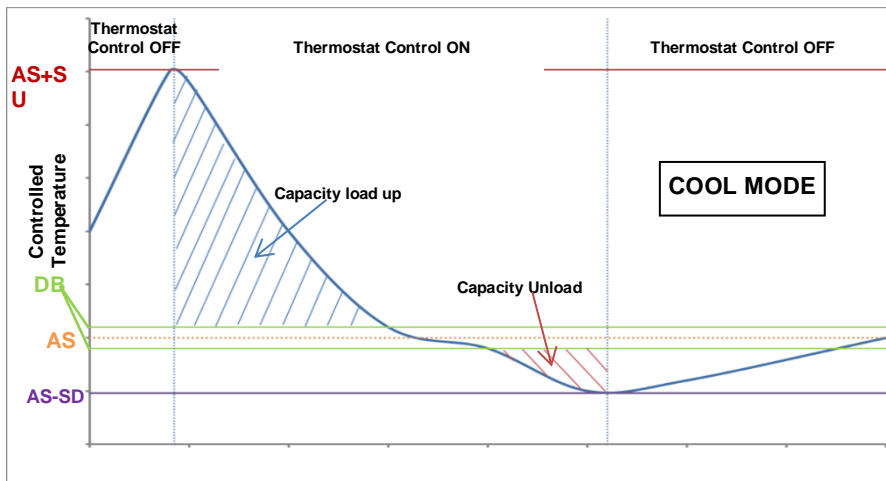

#### 5.1.4 Alarm Settings

If glycol is present in the water circuits, factory defaults values for the Alarm Limits listed below must be adjusted:

Parameter	Description
Low Press Hold	Set the minimum refrigerant pressure of the unit. It is generally recommended to set to a value whose saturated temperature is 8 to 10°C below the minimum active setpoint. This will allow a safe operation and a proper control of compressor suction superheat.
Low Press Unload	Set lower than the hold threshold enough to allow a suction pressure recovery from fast transients without unloading the compressor. A 20 kPa differential is generally appropriate for most applications.
Evap Water Frz	Stops the unit in case the leaving temperature falls below a given threshold. To allow a safe operation of the chiller, this setting must be adequate to the minimum temperature allowed by the mixture water/glycol present in the evaporator water circuit.
Cond Water Frz	Stops the unit in case the leaving temperature falls below a given threshold. To allow a safe operation of the chiller, this setting must be adequate to the minimum temperature allowed by the mixture water/glycol present in the condenser water circuit.



**When glycol is used in the plant, always disconnect antifreeze electric heater.**

### 5.1.4.1 Pumps

The UC can manage one or two water pumps for both evaporator and condenser. Number of pumps and their priority can be set from the menu in 4.2.3.

The following options are available to control the pump(s):

#1 Only	Set to this in case of single pump or twin pump with only #1 operational (f.e. in case of maintenance on #2)
#2 Only	Set to this in case of twin pump with only #2 operational (f.e. in case of maintenance on #1)
Auto	Set for automatic pump start management. At each chiller start, the pump with the least number of hours will be activated.
#1 Primary	Set to this in case of twin pump with #1 running and #2 as a backup
#2 Primary	Set to this in case of twin pump with #2 running and #1 as a backup

### 5.1.5 Power Conservation

#### 5.1.5.1 Demand Limit

Demand limit function allows the unit to be limited to a specified maximum load. Capacity limit level is defined with an external 4-20 mA signal and linear relationship. 4 mA indicate maximum capacity available whereas 20 mA indicates minimum capacity available.

With demand limit function is not possible shutdown the unit but only unload it until minimum admissible capacity. Demand limit related setpoints available through this menu are listed in the table below.

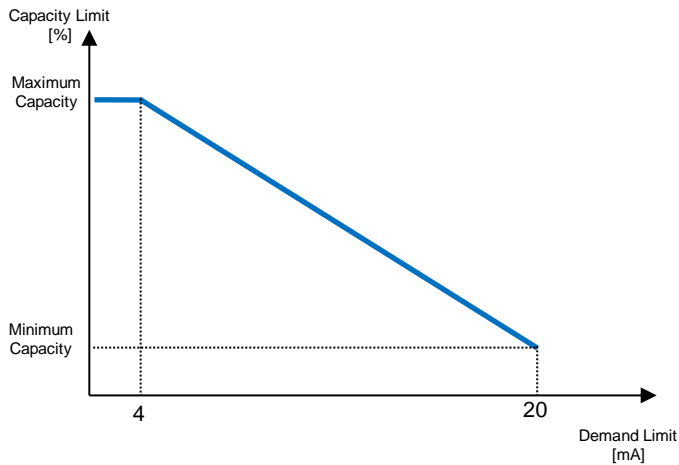

Parameter	Description
Unit Capacity	Displays current unit capacity
Demand Limit En	Enables demand limit
Demand Limit	Displays active demand limit

#### 5.1.5.2 Current Limit (Optional)

Current limit function allows to control unit power consumption taking current drawn below a specific limit. Starting from the Current Limit Setpoint defined through the HMI or BAS communication, user can decrease the real limit using an external 4-20mA signal as indicate in the graph below. With 20 mA real current limit is set to Current Limit Setpoint, whereas with 4 mA signal the unit is unloaded until minimum capacity.

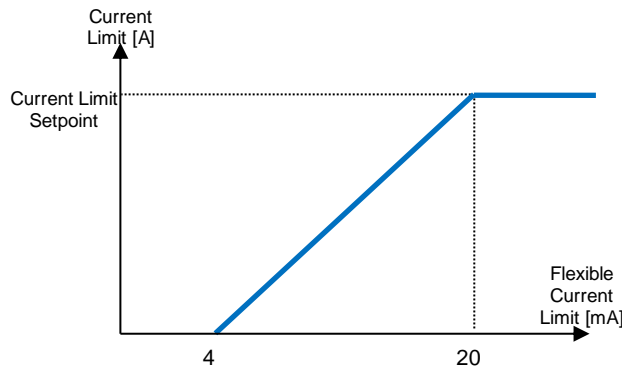

### 5.1.5.3 Setpoint Reset

The setpoint reset function overrides the chilled water temperature selected through the interface, when certain circumstances occur. This feature helps in reducing energy consumption optimizing comfort as well. Three different control strategies can be selected:

- Setpoint Reset by Outside Air Temperature (OAT)
- Setpoint Reset by an external signal (4-20mA)
- Setpoint Reset by Evaporator  $\Delta T$  (Return)

The following setpoints are available through this menu:

Parameter	Description
Setpoint Reset	Set the Setpoint Reset mode (None, 4-20 mA, Return, OAT)
Max Reset	Max Setpoint Reset (valid for all active modes)
Start Reset DT	Used on Setpoint Reset by Evaporator DT
Max Reset OAT	See Setpoint Reset by OAT Reset
Strt Reset OAT	See Setpoint Reset by OAT Reset

### 5.1.5.4 Setpoint Reset by External 4-20 mA Signal

The active setpoint is calculated applying a correction based on an external 4-20mA signal. 4 mA corresponds to 0°C correction, while 20 mA corresponds to a correction of the active setpoint as set in Max Reset (MR).

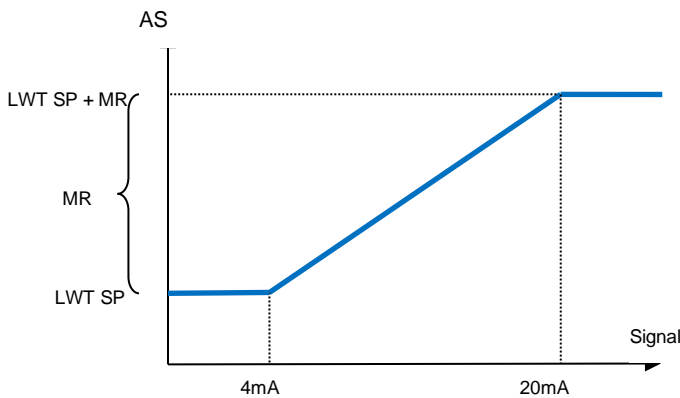

Parameter	Default	Range
Max Reset (MR)	5.0°C	0.0°C ÷ 10.0°C
Active Setpoint (AS)		
LWT Setpoint (LWT SP)		Cool/Ice LWT
Signal		4-20mA External signal

### 5.1.5.5 Setpoint Reset by Evaporator Return Temperature

The active setpoint is calculated applying a correction that depends on the evaporator entering (return) water temperature. As evaporator  $\Delta T$  becomes lower than the SR $\Delta T$  value, an offset to the LWT setpoint is increasingly applied, up to the MR value when the return temperature reaches the chilled water temperature.



*The Return Reset may affect negatively the chiller operation when operated with variable flow. Avoid to use this strategy in case of inverter water flow control.*

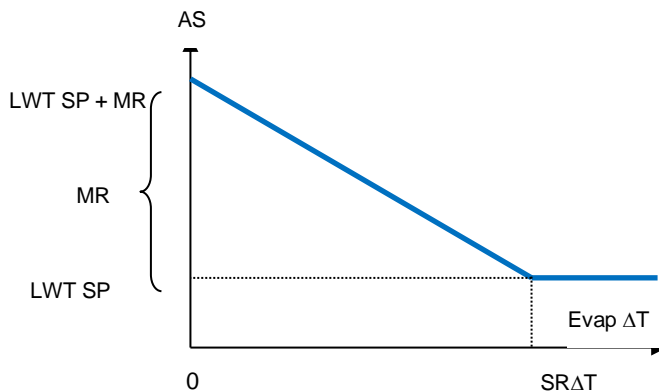

Parameter	Default	Range
Max Reset (MR)	5.0°C	0.0°C ÷ 10.0°C
Start Reset DT (SR $\Delta T$ )	5.0°C	0.0°C ÷ 10.0°C
Active Setpoint (AS)		
LWT Target (LWT SP)		Cool/Ice LWT

### 5.1.5.6 Soft Load

Soft Loading is a configurable function used to ramp up the unit capacity over a given time period, usually used to influence building electrical demand by gradually loading the unit. The setpoints that control this function are:

Parameter	Description
Softload En	Enables soft loading
Softload Ramp	Duration of the soft load ramp
Starting Cap	Begin capacity limit. Unit will increase capacity from this value to 100% over the time specified by the Softload Ramp setpoint.

### 5.1.6 Date/Time

#### 5.1.6.1 Date, Time and UTC Settings

See 4.2.4.

## 5.2 Unit/Circuit Start-up

In this section, starting and stopping sequence of the unit will be described. status will be briefly described to allow a better understanding of what is going on into the chiller control.

### 5.2.1 Unit Status

One of the texts strings listed in the table below will inform, on the HMI, about the Unit Status.

Overall Status	Status text	Description
Off:	Keypad Disable	The Unit has been disabled by keypad. Check with your local maintenance if it can be enabled.
	Loc/Rem Switch	The Local/Remote enable switch is set to disable. Turn it to Local to enable the unit to start its starting sequence.
	BAS Disable	Unit is disabled by BAS/BMS system. Check with the BAS company how to start the unit.
	Master Disable	Unit is disabled by the Master Slave function
	Scheduler Disabled	Unit is disabled by the time scheduler.
	Unit Alarm	A unit alarm is active. Check the alarm list to see what is the active alarm inhibiting the unit to start and check if the alarm can be cleared. Refer to section 6. before proceeding.
	Test Mode	Unit mode set to Test. This mode is activated to check operability of onboard actuators and sensors. Check with the local maintenance if the Mode can be reverted to the one compatible with unit application (View/Set Unit – Set-Up – Available Modes).
	All Cir Disabled	No circuit is available to run. All circuits can be disabled by their individual enable switch or can be disabled by a component safety condition active or can be disabled by keypad or can be all in alarms. Check the individual circuit status for further details.
	Ice Mode Tmr	This status can be shown only if the unit can work in Ice Mode. The unit is off because the Ice setpoint has been satisfied. Unit will remain off until the Ice Timer has expired.
Auto		Unit is in Auto control. The pump is running and at least one compressor is running.
Auto:	Evap Recirc	Unit is running the evaporator pump to equalize the water temperature in the evaporator.
	Wait For Flow	Unit pump is running but the flow signal still indicate a lack of flow through the evaporator.
	Wait For Load	Unit is in standby because the thermostat control satisfied the active setpoint.
	Unit Cap Limit	Demand limit has been hit. Unit capacity will not further increase.
	Current Limit	Maximum current has been hit. Unit capacity will not further increase.
	Noise Reduction	Unit is running with the Quiet Mode activated. Active setpoint may differ from what has been set as cooling setpoint.
	Max Pulldn	Unit thermostat control is limiting the unit capacity because the water temperature is dropping at a rate that could exceed the active setpoint.
	Pumpdn	Unit is shutting down.

## 5.2.2 Prepare the unit to start

The unit starts only if all the enable setpoints/signals are active:

- Unit Switch Enable (signal) = Enable
- Keypad Enable (setpoint) = Enable
- BMS Enable (setpoint) = Enable

### 5.2.2.1 Unit Switch Enable

Each unit is equipped with a Main selector installed outside the front panel of the unit switchbox. As shown in the pictures below, for VZ units, two different positions can be selected: Local, Disable:



**Local** *With the Q0 switch in this position the unit is enabled. Pump will start if all other enable signals are set to enable and at least one compressor is available to run*

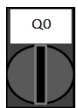

**Disable** *With the Q0 switch in this position the unit is disabled. Pump will not start in normal operational condition. Compressor are kept disabled independently from the status of the individual enable switches.*

### 5.2.2.2 Keypad Enable

The Keypad enable setpoint is not accessible by user password level. If it is set to "Disable", contact your local maintenance service to check if it can be changed to Enable.

### 5.2.2.1 BMS Enable

The last enable signal is coming through the high level interface, that is from a Building Management System. The unit can be enabled/disabled from a BMS connected to the UC using a communication protocol. In order to control the unit over the network, the Control Source setpoint must be turned in "Network" (default is Local) and Network En Sp must be "Enable" (4.2.2). If disabled, check with your BAS company how the chiller is operated.

## 5.2.3 Unit Start sequence

As soon as the unit is ready to start and then its status turns to Auto, begins the main steps indicated in the following simplified flowchart:

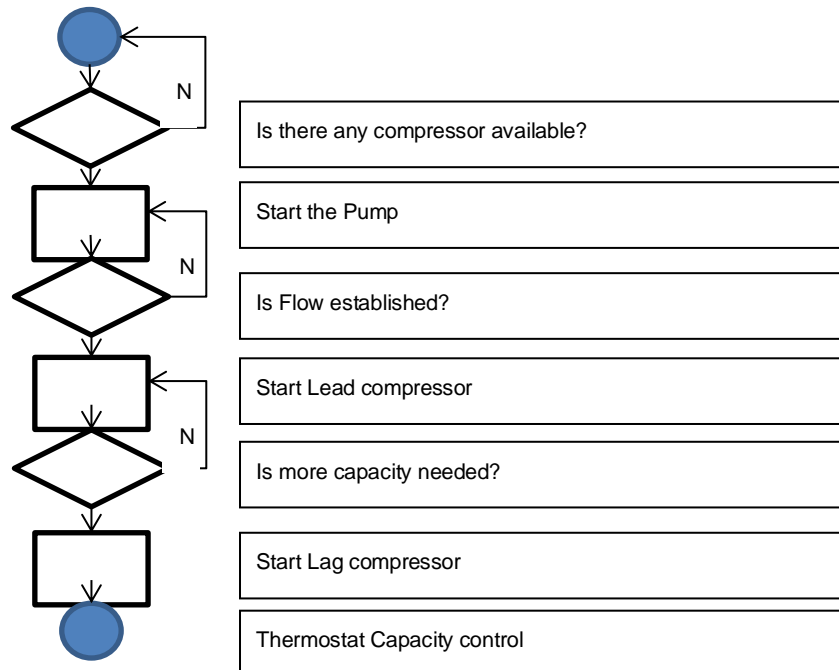

## 5.2.4 Circuit Status

One of the texts strings listed in the table below will inform, on the HMI, about the Circuit Status.

Overall Status	Status	Description
Off:	Ready	Circuit is off waiting for a stage up signal from thermostat control
	Stage Up Delay	Circuit is off waiting for the stage up delay to expire.
	Cycle Timer	Circuit is off waiting for the compressor cycle timer to expire
	BAS Disable	Circuit is off by BAS signal. Check with the BAS company how to start the unit.
	Keypad Disable	Circuit is off by the local or remote HMI. Check with your local maintenance if it can be enabled.
	Circuit Switch	Circuit is off by Enable switch. Turn the Enable switch to 1 to allow the circuit start up procedure to start
	Oil Heating	Circuit is off because the oil temperature is too low to guarantee a proper lubrication of compressor. Heating resistor is activated to eliminate this temporary condition. It's suggested to power up the unit in advance to avoid this limiting condition.
	Alarm	A circuit alarm is active. Check the alarm list to see what is the active alarm inhibiting the circuit to start and check if the alarm can be cleared. Refer to section 6.before proceeding.
	Test Mode	Circuit mode set to Test. This mode is activated to check operability of onboard circuit actuators and sensors. Check with the local maintenance if the Mode can be reverted to Enable.
	Max Comp Starts	Compressor starts exceed the maximum number of starts per hour.
	VFD Heating	Inverter on compressor cannot start because of low internal temperature. Heating resistor is activated to eliminate this temporary condition. It's suggested to power up the unit in advance to avoid this limiting condition.
	Maintenance	A component needs to be replaced or maintained. Refer to section 6.before proceeding.
EXV	Preopen	EXV repositioning before compressor starts.
Run:	Pumpdown	Circuit is shutting down because of thermostat control or pumpdown alarm or because the enable switch has been turned to off.
	Normal	Circuit is running within the expected operational conditions.
	Disch SH Low	Discharge superheat is below the acceptable value. This is a temporary condition that should disappear after few minutes of operation.
	Evap Press Low	Circuit is running with low evaporator pressure. This could be due to a transitory condition or a lack of refrigerant. Check with the local maintenance if corrective actions are required. Circuit is protected by preventive logic.
	Cond Press High	Circuit is running with high condenser pressure. This could be due to a transitory condition or high ambient temperature or problems with the condenser fans. Check with the local maintenance if corrective actions are required. Circuit will be protected by preventive logic.
	High LWT Limit	Circuit is running with a high water temperature. This is a temporary condition that will limit the maximum compressor capacity. Reduction of the water temperature will allow the compressor to reach the full capacity.
	High VFD Amps	Inverter current is higher than the maximum allowed current. Preventive logic will protect the inverter.

### 5.2.5 Circuits start sequence

To allow a circuit start up is required to enable the circuit using the enable switch located on the unit switchbox. Each circuit is equipped with a dedicated switch identified with Q1, Q2 (if available) or Q3 (if available). The enable position is indicated with a 1 on the label whereas the 0 position corresponds to disable.

The status of the circuit is indicated in the View/Set Circuit – Circuit #x – Status/Settings. The possible status will be described in the following table.

If the circuit is allowed to start, the starting sequence is initiated. Starting sequence is described in a simplified version with the further flowchart.

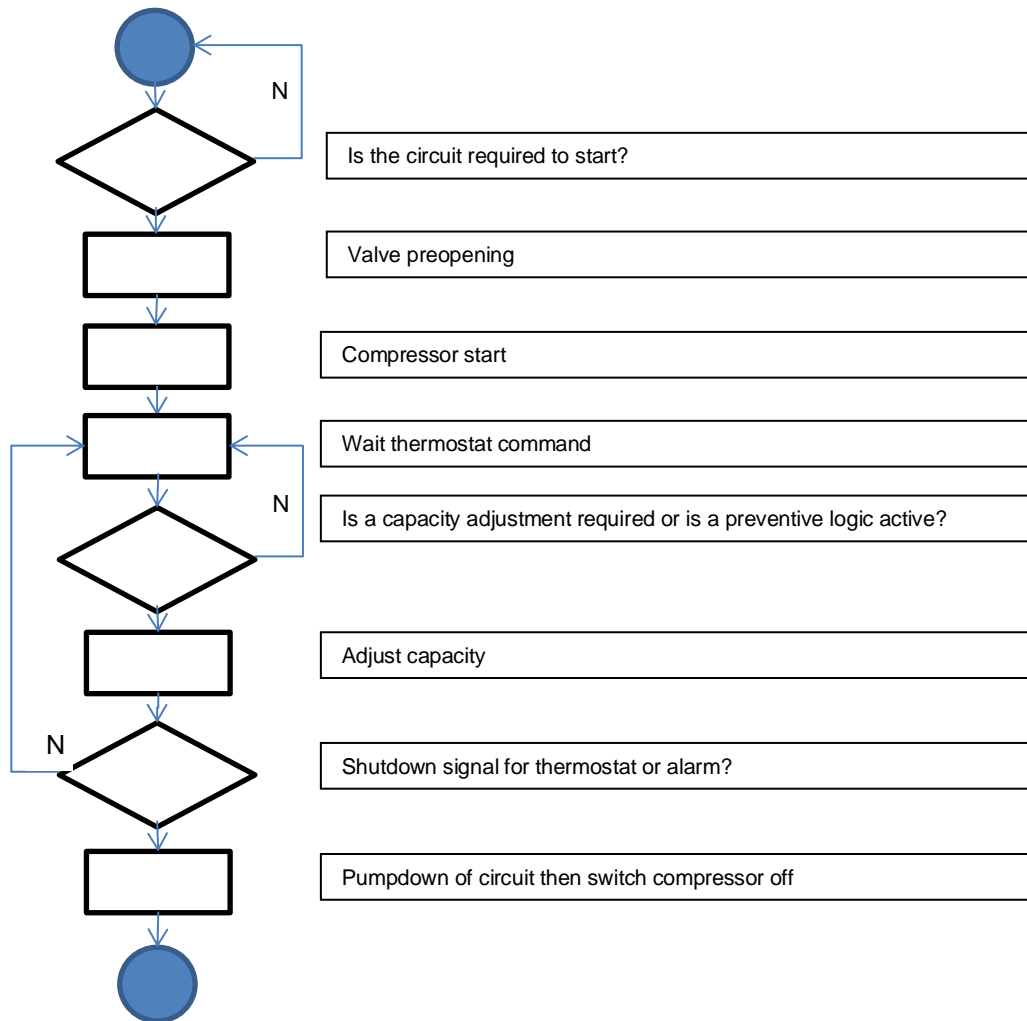

### 5.2.6 Low Evaporating Pressure

When the circuit is running and the evaporating pressure drops below the safety limits (see section 4.12.1) the circuit control logic reacts at two different levels in order to recover the normal running conditions.

If the evaporating pressure drops below the Low Pressure Hold limit, compressor is inhibited to increase its running capacity. This condition is indicated on the controller display in the circuit status as “Run: Evap Press Low”. The status is automatically cleared when the evaporating pressure rise above the Low Pressure Hold limit by 14 kPa.

If the evaporating pressure drops below the Low Pressure Unld limit, compressor is unloaded in order to recover the normal operating conditions. This condition is indicated on the controller display in the circuit status as “Run: Evap Press Low”. The status is automatically cleared when the evaporating pressure rise above the Low Pressure Hold limit by 14 kPa.

See section 6.6.13 to troubleshoot this problem.



### 5.2.7 High Condensing Pressure

When the circuit is running and the condensing pressure rises above the safety limits the circuit control logic reacts at two different levels in order to recover the normal running conditions.

The two different levels, called High Pressure Hold and High Pressure Unload limits, are calculated by the controller from the maximum condenser pressure allowed by the compressor envelope. This value depends from evaporating pressure as reported in the figure below.

If the condensing pressure rises above the High Pressure Hold limit, compressor is inhibited to increase its running capacity. This condition is indicated on the controller display in the circuit status as "Run: Cond Press High". The limit is calculated in terms of saturated condensing temperature; the status is automatically cleared when the saturated condensing temperature rises above the High Pressure Hold limit by 5.6°C.

If the condensing pressure rises above the High Pressure Unload limit, compressor is unloaded in order to recover the normal operating conditions. This condition is indicated on the controller display in the circuit status as "Run: Cond Press High". The status is automatically cleared when the saturated condensing temperature rises above the High Pressure Hold limit by 5.6°C. See section 6.6.12 to troubleshoot this problem.

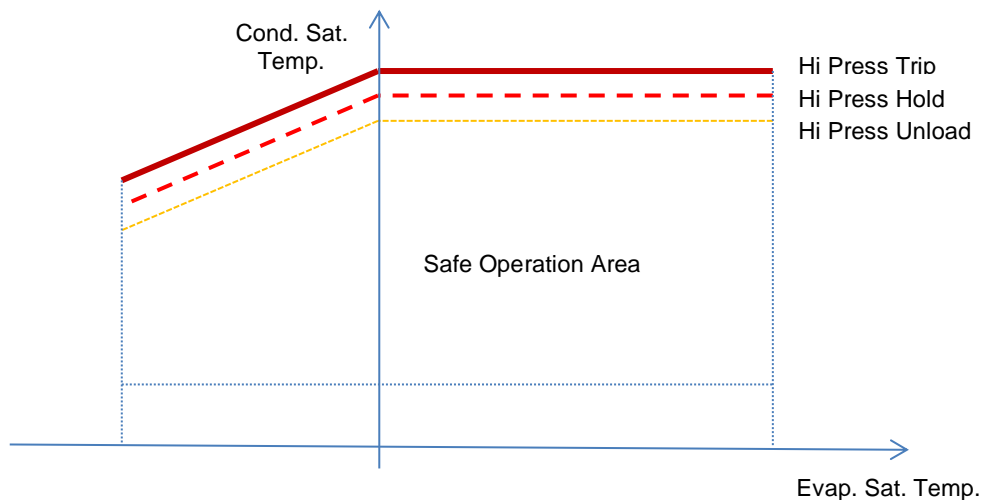

### 5.2.8 High Vfd Current

When the compressor is running and its output current rises above the safety limits the circuit control logic reacts at two different levels in order to recover the normal running conditions. Safety limits are calculated by the controller based on the selected compressor type.

If the running current rises above the Running Current Hold limit (101% of RLA), compressor is inhibited to increase its running capacity. This condition is indicated on the controller display in the circuit status as "Run: High VFD Amps".

If the condensing pressure rises above the Running Current Unload limit (105% of RLA), compressor is unloaded in order to recover the normal operating conditions. This condition is indicated on the controller display in the circuit status as "Run: High VFD Amps". The status is automatically cleared when the running amps falls below the hold limit.

### 5.2.9 High Discharge Temperature

When the compressor is running and its discharge temperature rises above the safety limits the circuit control logic reacts at two different levels in order to recover the normal running conditions.

If the discharge temperature rises above the Discharge Temperature Hold limit (95°C), compressor is inhibited to increase its running capacity. This condition is indicated on the controller display in the circuit status as "Run: High Discharge Temp".

If the discharge temperature rises above the Discharge Temperature Unload limit (100°C), compressor is unloaded in order to recover the normal operating conditions. This condition is indicated on the controller display in the circuit status as "Run: High Discharge Temp". The status is automatically cleared when the discharge temperature falls below the hold limit.

### 5.3 Condensation Control

Condenser Entering Water Temperature is controlled in order to achieve best chiller efficiency within compressor envelope limits. To do this, application manages the outputs for the control of the following condensation devices:

- Tower fan #1...4 by mean of 4 on/off signals. Tower fan # state is on when Cond EWT is greater then the Cond EWT setpoint. Tower fan # state is off when Cond EWT is lower then Setpoint – Diff. The picture below represents an example of activation and deactivation sequence based on Cond EWT present value relation with set points and differentials listed in 4.2.4.

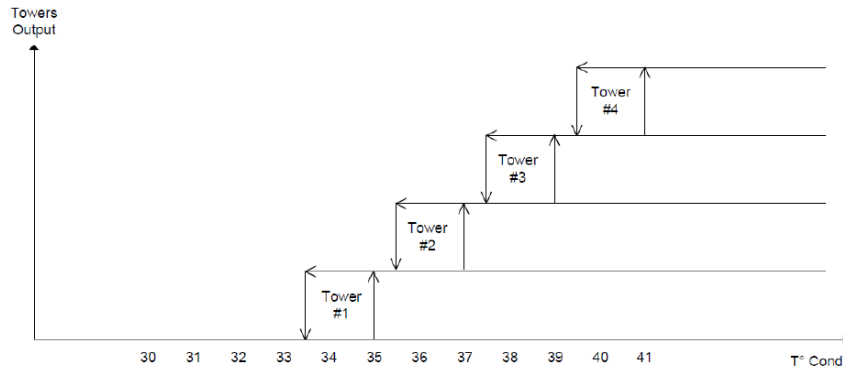

- 1 Vfd by mean of a modulating 0-10V signal generated through a PID controller. The following graph is an example of the modulating signal behavior in case of a PID control supposed to be purely proportional.

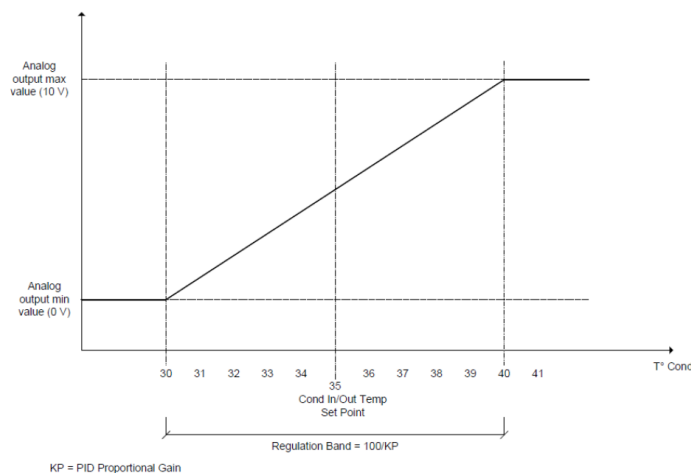

### 5.4 EXV Control

As a standard, the unit is equipped with one electronic expansion valve (EXV) per circuit, moved by a stepper motor. The EXV controls the thermodynamic cycle (evaporator) in order to optimize evaporator efficiency and at the same time guarantee the proper operation of the circuit.

The controller integrates a PID algorithm which manages the dynamic response of the valve in order to keep a satisfactory quick and stable response to system parameter variations.

In Pressure control, the EXV is positioned to control the evaporator pressure and avoid that it can go above the MOP.

When the EXV transitions to the Superheat control, the superheat target is calculated to maximize the evaporator surface used to exchange heat with the other medium. This target is constantly updated, and averaged over a 10 second period.

Whenever the circuit is running, the EXV position is limited between 5% or 100% position.

Any time the circuit is in the Off or starts the shutdown procedure, the EXV shall be in the closed position. In this case additional closing steps are commanded to guarantee a proper recovery of the zero position.

Expansion valve driver is equipped with UPS module to safely close the expansion valve in case of power failure.

## **5.5 Liquid Injection Control**

Liquid injection will be activated when the discharge temperature rises above a safety limit temperature to avoid compressor components overheating.

Liquid injection will be turned off when the discharge temperature decreases below the activation.

## **5.6 Variable Volume Ratio Control**

VVR (Variable Volume Ratio) slides in the compressor adapt discharge port geometry to achieve optimum compressor efficiency according to chiller operating conditions. The proper Compressor Volume Ratio is determined by the application basing on pressure ratio present value and obtained energizing slides to drive them in the needed position. Number of available volume ratios depends on compressor model.

## 6 ALARMS AND TROUBLESHOOTING

The UC protects the unit and the components from operating in abnormal conditions. Protections can be divided in preventions and alarms. Alarms can then be divided in pump-down and rapid stop alarms. Pump-down alarms are activated when the system or sub-system can perform a normal shutdown in spite of the abnormal running conditions. Rapid stop alarms are activated when the abnormal running conditions require an immediate stop of the whole system or sub-system to prevent potential damages.

The UC displays the active alarms in a dedicated page and keep an history of the last 50 entries divided between alarms and acknowledges occurred. Time and date for each alarm event and of each alarm acknowledge are stored.

The UC also stores alarm snapshot of each alarm occurred. Each item contains a snapshot of the running conditions right before the alarm has occurred. Different sets of snapshots are programmed corresponding to unit alarms and circuit alarms holding different information to help the failure diagnosis.

In the following sections it will also be indicated how each alarm can be cleared between local HMI, Network (by any of the high level interfaces Modbus, Bacnet or Lon) or if the specific alarm will clear automatically. The following symbols are used:

<input checked="" type="checkbox"/>	Allowed
<input checked="" type="checkbox"/>	Not allowed
<input type="checkbox"/>	Not foreseen

### 6.1 Unit Alerts

#### 6.1.1 Bad Current Limit Input

This alarm is generated when the Flexible Current Limit option has been enabled and the input to the controller is out of the admitted range.

Symptom	Cause	Solution
Unit status is Run. Bell icon is moving on controller's display. Flexible Current Limit function cannot be used. String in the alarm list: BadCurrentLimitInput String in the alarm log: ± BadCurrentLimitInput String in the alarm snapshot BadCurrentLimitInput	Flexible current limit input out of range. For this warning out of range is considered to be a signal less than 3mA or more than 21mA.	Check for values of input signal to the unit controller. It has to be in the allowed mA range. Check for electrical shielding of wirings. Check for right value of the unit's controller output in case input signal is into allowed range.
Reset		Notes
Local HMI Network Auto	<input type="checkbox"/> <input type="checkbox"/> <input checked="" type="checkbox"/>	Automatically clears when the signal returns in the allowed range.

#### 6.1.2 Bad Demand Limit Input

This alarm is generated when the Demand Limit option has been enabled and the input to the controller is out of the admitted range.

Symptom	Cause	Solution
Unit status is Run. Bell icon is moving on controller's display. Demand Limit function cannot be used. String in the alarm list: BadDemandLimitInput String in the alarm log: ±BadDemandLimitInput String in the alarm snapshot BadDemandLimitInput	Demand limit input out of range. For this warning out of range is considered to be a signal less than 3mA or more than 21mA.	Check for values of input signal to the unit controller. It has to be in the allowed mA range. Check for electrical shielding of wirings. Check for right value of the unit's controller output in case input signal is into allowed range.
Reset		Notes
Local HMI Network Auto	<input type="checkbox"/> <input type="checkbox"/> <input checked="" type="checkbox"/>	Automatically clears when the signal returns in the allowed range.

### 6.1.3 Bad Leaving Water Temperature Reset Input

This alarm is generated when the Setpoint Reset option has been enabled and the input to the controller is out of the admitted range.

Symptom	Cause	Solution
Unit status is Run. Bell icon is moving on controller's display. LWT Reset function cannot be used. String in the alarm list: BadSetPtOverrideInput String in the alarm log: ± BadSetPtOverrideInput String in the alarm snapshot BadSetPtOverrideInput	LWT reset input signal is out of range. For this warning out of range is considered to be a signal less than 3mA or more than 21mA.	Check for values of input signal to the unit controller. It has to be in the allowed mA range. Check for electrical shielding of wirings. Check for right value of the unit's controller output in case input signal is into allowed range.
Reset		Notes
Local HMI Network Auto	<input type="checkbox"/> <input type="checkbox"/> <input checked="" type="checkbox"/>	Automatically clears when the signal returns in the allowed range.

### 6.1.4 Condenser Pump #1 Failure (W/C units only)

This alarm is generated if the pump is started but the flow switch is not able to close within the recirculate time. This can be a temporary condition or may be due to a broken flowswitch, the activation of circuit breakers, fuses or to a pump breakdown.

Symptom	Cause	Solution
Unit could be ON. Bell icon is moving on controller's display. Backup pump is used or stop of all circuits in case of pump #2 failure. String in the alarm list: CondPump1Fault String in the alarm log: ± CondPump1Fault String in the alarm snapshot CondPump1Fault	Pump #1 may not be operating.	Check for problem in electrical wiring of the pump #1. Check that electrical breaker of pump #1 is tripped. If fuses are used to protect the pump, check the integrity of fuses. Check for problem in wiring connection between pump starter and unit controller. Check the water pump filter and the water circuit for obstructions.
	Flow Switch doesn't operate properly	Check flow switch connection and calibration.
Reset		Notes
Local HMI Network Auto	<input checked="" type="checkbox"/> <input checked="" type="checkbox"/> <input type="checkbox"/>	

### 6.1.5 Condenser Pump #2 Failure (W/C units only)

This alarm is generated if the pump is started but the flow switch is not able to close within the recirculate time. This can be a temporary condition or may be due to a broken flowswitch, the activation of circuit breakers, fuses or to a pump breakdown.

Symptom	Cause	Solution
Unit could be ON. Bell icon is moving on controller's display. Backup pump is used or stop of all circuits in case of pump #1 failure. String in the alarm list: CondPump2Fault String in the alarm log: ± CondPump2Fault String in the alarm snapshot CondPump2Fault	Pump #1 may not be operating.	Check for problem in electrical wiring of the pump #1. Check that electrical breaker of pump #1 is tripped. If fuses are used to protect the pump, check the integrity of fuses. Check for problem in wiring connection between pump starter and unit controller. Check the water pump filter and the water circuit for obstructions.
	Flow Switch doesn't operate properly	Check flow switch connection and calibration.
Reset		Notes
Local HMI Network Auto	<input checked="" type="checkbox"/> <input checked="" type="checkbox"/> <input type="checkbox"/>	

### 6.1.6 Energy Meter Communication Fail

This alarm is generated in case of communication problems with the energy meter.

Symptom	Cause	Solution
Bell icon is moving on controller's display. String in the alarm list: EnergyMtrCommFail String in the alarm log: ± EnergyMtrCommFail String in the alarm snapshot EnergyMtrCommFail	Module has no power supply	Refer to the datasheet of the specific component to see if it is correctly powered
	Wrong cabling with the Unit Controller	Check if the polarity of the connections is respected.
	Modbus parameters not properly set	Referring to the datasheet of the specific component to see if the modbus parameters are set correctly: Address = 20 Baud Rate = 19200 kBs Parity = None Stop bits =1
	Module is broken	Check if the display shows something and the power supply is present.
Reset		Notes
Local HMI Network Auto	<input type="checkbox"/> <input type="checkbox"/> <input checked="" type="checkbox"/>	Automatically clears when the communication is re-established.

### 6.1.7 Evaporator Pump #1 Failure

This alarm is generated if the pump is started but the flow switch is not able to close within the recirculate time. This can be a temporary condition or may be due to a broken flowswitch, the activation of circuit breakers, fuses or to a pump breakdown.

Symptom	Cause	Solution
Unit could be ON. Bell icon is moving on controller's display. Backup pump is used or stop of all circuits in case of pump #2 failure. String in the alarm list: EvapPump1Fault String in the alarm log: ± EvapPump1Fault String in the alarm snapshot EvapPump1Fault	Pump #1 may not be operating.	Check for problem in electrical wiring of the pump #1.
		Check that electrical breaker of pump #1 is tripped.
		If fuses are used to protect the pump, check the integrity of fuses.
		Check for problem in wiring connection between pump starter and unit controller.
	Flow Switch doesn't operate properly	Check the water pump filter and the water circuit for obstructions.
		Check flow switch connection and calibration.
Reset		Notes
Local HMI Network Auto	<input checked="" type="checkbox"/> <input checked="" type="checkbox"/> <input type="checkbox"/>	

### 6.1.8 Evaporator Pump #2 Failure

This alarm is generated if the pump is started but the flow switch is not able to close within the recirculate time. This can be a temporary condition or may be due to a broken flowswitch, the activation of circuit breakers, fuses or to a pump breakdown.

Symptom	Cause	Solution
Unit could be ON. Bell icon is moving on controller's display. Backup pump is used or stop of all circuits in case of pump #1 failure. String in the alarm list: EvapPump2Fault String in the alarm log: ± EvapPump2Fault String in the alarm snapshot EvapPump2Fault	Pump #2 may not be operating.	Check for problem in electrical wiring of the pump #2.
		Check that electrical breaker of pump #2 is tripped.
		If fuses are used to protect the pump, check the integrity of fuses.
		Check for problem in wiring connection between pump starter and unit controller.
	Flow Switch doesn't operate properly	Check the water pump filter and the water circuit for obstructions.
		Check flow switch connection and calibration.
Reset		Notes
Local HMI Network Auto	<input checked="" type="checkbox"/> <input checked="" type="checkbox"/> <input type="checkbox"/>	

### 6.1.9 External Event

This alarm indicates that a device, whose operation is linked with this machine, is reporting a problem on the dedicated input.

Symptom	Cause	Solution
Unit status is Auto. Bell icon is moving on controller's display. String in the alarm list: UnitExternalEvent String in the alarm log: ±UnitExternalEvent String in the alarm snapshot UnitExternalEvent	There is an external event that has caused the opening, for at least 5 seconds, of the digital input on the controller board.	Check for reasons of external event and if it can be a potential problem for a correct chiller operation.
Reset		Notes
Local HMI Network Auto	<input type="checkbox"/> <input type="checkbox"/> <input checked="" type="checkbox"/>	The alarm is automatically cleared when the problem is solved.
NOTE: What above applies in case of configuration of the external fault digital input as Event		

### 6.1.10 Rapid Recovery Module Communication Fail

This alarm is generated in case of communication problems with the RRC module.

Symptom	Cause	Solution
Bell icon is moving on controller's display. String in the alarm list: RpdRcvryCommFail String in the alarm log: ± RpdRcvryCommFail String in the alarm snapshot RpdRcvryCommFail	Module has no power supply	Check the power supply from the connector on the side of the module. Check if LEDs are both green. Check if the connector on the side is tightly inserted in the module
	Module address is not properly set	Check if module's address is correct referring to the wiring diagram.
	Module is broken	Check if LED are on and both green. If BSP LED is solid red replace the module Check if power supply is ok but LEDs are both off. In this case replace the module
Reset		Notes
Local HMI Network Auto	<input checked="" type="checkbox"/> <input checked="" type="checkbox"/> <input type="checkbox"/>	

## 6.2 Unit Pumpdown Stop Alarms

### 6.2.1 Condenser Entering Water Temperature (EWT) sensor fault

This alarm is generated any time the input resistance is out of an acceptable range.

Symptom	Cause	Solution
Unit status is Off. All circuits are stopped with a normal shutdown procedure. Bell icon is moving on controller's display. String in the alarm list: UnitOffCndEntWTempSen String in the alarm log: ± UnitOffCndEntWTempSen String in the alarm snapshot UnitOffcndEntWTempSen	Sensor is broken.	Check for sensor integrity according table and allowed kOhm (kΩ) range. Check correct sensors operation
	Sensor is shorted.	Check if sensor is shorted with a resistance measurement.
	Sensor is not properly connected (open).	Check for absence of water or humidity on electrical contacts. Check for correct plug-in of the electrical connectors. Check for correct sensors wiring also according electrical scheme.
Reset		Notes
Local HMI Network Auto	<input checked="" type="checkbox"/> <input checked="" type="checkbox"/> <input type="checkbox"/>	

### 6.2.2 Condenser Leaving Water Temperature (LWT) sensor fault

This alarm is generated any time the input resistance is out of an acceptable range.

Symptom	Cause	Solution
Unit status is Off. All circuits are stopped with a normal shutdown procedure. Bell icon is moving on controller's display. String in the alarm list: UnitOffCndLvgWTempSen String in the alarm log: ± UnitOffCndLvgWTempSen String in the alarm snapshot UnitOffcndLvgWTempSen	Sensor is broken.	Check for sensor integrity according table and allowed kOhm (kΩ) range. Check correct sensors operation
	Sensor is shorted.	Check if sensor is shorted with a resistance measurement.
	Sensor is not properly connected (open).	Check for absence of water or humidity on electrical contacts.
		Check for correct plug-in of the electrical connectors.
Reset		Notes
Local HMI	<input checked="" type="checkbox"/>	
Network	<input checked="" type="checkbox"/>	
Auto	<input type="checkbox"/>	

### 6.2.3 Evaporator Entering Water Temperature (EWT) sensor fault

This alarm is generated any time the input resistance is out of an acceptable range.

Symptom	Cause	Solution
Unit status is Off. All circuits are stopped with a normal shutdown procedure. Bell icon is moving on controller's display. String in the alarm list: UnitOffEvpEntWTempSen String in the alarm log: ± UnitOffEvpEntWTempSen String in the alarm snapshot UnitOffEvpEntWTempSen	Sensor is broken.	Check for sensor integrity according table and allowed kOhm (kΩ) range. Check correct sensors operation
	Sensor is shorted.	Check if sensor is shorted with a resistance measurement.
	Sensor is not properly connected (open).	Check for absence of water or humidity on electrical contacts.
		Check for correct plug-in of the electrical connectors.
Reset		Notes
Local HMI	<input checked="" type="checkbox"/>	
Network	<input checked="" type="checkbox"/>	

### 6.2.4 Evaporator Water Temperatures inverted

This alarm is generated any time the entering water temperature is lower than the leaving by 1°C and at least one compressor is running since 90 seconds.

Symptom	Cause	Solution
Unit status is Off. All circuits are stopped with a normal shutdown procedure. Bell icon is moving on controller's display. String in the alarm list: UnitOffEvpWTempInvrted String in the alarm log: ± UnitOffEvpWTempInvrted String in the alarm snapshot UnitOffEvpWTempInvrted	Entering and leaving water temperature sensors are inverted.	Check cabling of the sensors on the unit controller. Check offset of the two sensors with the water pump running
	Entering and leaving water pipes are reversed	Check if the water flows in counter flow respect to refrigerant.
	Water pump operate reverse.	Check if the water flows in counter flow respect to refrigerant.
Reset		Notes
Local HMI	<input checked="" type="checkbox"/>	
Network	<input checked="" type="checkbox"/>	
Auto	<input type="checkbox"/>	



### 6.3 Unit Rapid Stop Alarms

#### 6.3.1 Condenser Water Freeze alarm

This alarm is generated to indicate that the water temperature (entering or leaving) has dropped below a safety limit. Control tries to protect the heat exchanger starting the pump and letting the water circulate.

Symptom	Cause	Solution
Unit status is Off. All circuits are stopped immediately. Bell icon is moving on controller's display. String in the alarm list: UnitOffCondWaterTmpLo String in the alarm log: ± UnitOffCondWaterTmpLo String in the alarm snapshot UnitOffCondWaterTmpLo	Water flow too low.	Increase the water flow.
	Inlet temperature to the evaporator is too low.	Increase the inlet water temperature.
	Flow switch is not working or no water flow.	Check the flow switch and the water pump.
	Refrigerant temperature become too low (< -0.6°C).	Check the water flow and filter. No good heat exchange condition into the evaporator.
	Sensors readings (entering or leaving) are not properly calibrated	Check the water temperatures with a proper instrument and adjust the offsets
	Wrong freeze limit setpoint	The freeze limit has not been changed as a function of glycol percentage.
Reset		Notes
Local HMI	<input checked="" type="checkbox"/>	It's required to check if the condenser has any damage due to this alarm.
Network	<input checked="" type="checkbox"/>	
Auto	<input type="checkbox"/>	

#### 6.3.2 Condenser Water Flow Loss alarm

This alarm is generated in case of flow loss to the chiller to protect the machine against Mechanical High Pressure trips.

Symptom	Cause	Solution
Unit status is Off. All circuits are stopped immediately. Bell icon is moving on controller's display. String in the alarm list: UnitOffCondWaterFlow String in the alarm log: ± UnitOffCondWaterFlow String in the alarm snapshot UnitOffCondWaterFlow	No water flow sensed for 3 minutes continuously or water flow too low.	Check the water pump filler and the water circuit for obstructions.
		Check the flow switch calibration and adapt to minimum water flow.
		Check if pump impeller can rotate freely and has no damages.
		Check pumps protection devices (circuit breakers, fuses, inverters, etc.)
		Check if water filter is clogged.
		Check flow switch connections.
Reset		Notes
Local HMI	<input checked="" type="checkbox"/>	
Network	<input checked="" type="checkbox"/>	
Auto	<input type="checkbox"/>	

#### 6.3.3 Emergency Stop

This alarm is generated any time the Emergency Stop button is activated.



**Before resetting the Emergency Stop button please verify that the harmful condition has been removed.**

Symptom	Cause	Solution
Unit status is Off. All circuits are stopped immediately. Bell icon is moving on controller's display. String in the alarm list: UnitOffEmergencyStop String in the alarm log: ± UnitOffEmergencyStop String in the alarm snapshot UnitOffEmergencyStop	Emergency stop button has been pushed.	Turning counterclockwise the emergency stop button, the alarm should be cleared.
Reset		Notes
Local HMI	<input checked="" type="checkbox"/>	Please see note on the top.
Network	<input checked="" type="checkbox"/>	
Auto	<input type="checkbox"/>	

### 6.3.4 Evaporator Flow Loss alarm

This alarm is generated in case of flow loss to the chiller to protect the machine against freezing.

Symptom	Cause	Solution
Unit status is Off. All circuits are stopped immediately. Bell icon is moving on controller's display. String in the alarm list: UnitOffEvapWaterFlow String in the alarm log: ± UnitOffEvapWaterFlow String in the alarm snapshot UnitOffEvapWaterFlow	No water flow sensed for 3 minutes continuously or water flow too low.	Check the water pump filler and the water circuit for obstructions.
		Check the flow switch calibration and adapt to minimum water flow.
		Check if pump impeller can rotate freely and has no damages.
		Check pumps protection devices (circuit breakers, fuses, inverters, etc.)
		Check if water filter is clogged.
		Check flow switch connections.
Reset		Notes
Local HMI	<input checked="" type="checkbox"/>	
Network	<input checked="" type="checkbox"/>	
Auto	<input type="checkbox"/>	

### 6.3.5 Evaporator Leaving Water Temperature (LWT) sensor fault

This alarm is generated any time that the input resistance is out of an acceptable range.

Symptom	Cause	Solution
Unit status is Off. All circuits are stopped with a normal shutdown procedure. Bell icon is moving on controller's display. String in the alarm list: UnitOffEvpLvgWTempSen String in the alarm log: ± UnitOffEvpLvgWTempSen String in the alarm snapshot UnitOffEvpLvgWTempSen	Sensor is broken.	Check for sensor integrity according table and allowed kOhm (kΩ) range. Check correct sensors operation
	Sensor is shorted.	Check if sensor is shorted with a resistance measurement.
	Sensor is not properly connected (open).	Check for absence of water or humidity on electrical contacts.
		Check for correct plug-in of the electrical connectors. Check for correct sensors wiring also according electrical scheme.
Reset		Notes
Local HMI	<input checked="" type="checkbox"/>	
Network	<input checked="" type="checkbox"/>	
Auto	<input type="checkbox"/>	

### 6.3.6 Evaporator Water Freeze alarm

This alarm is generated to indicate that the water temperature (entering or leaving) has dropped below a safety limit. Control tries to protect the heat exchanger starting the pump and letting the water circulate.

Symptom	Cause	Solution
Unit status is Off. All circuits are stopped immediately. Bell icon is moving on controller's display. String in the alarm list: UnitOffEvapWaterTmpLo String in the alarm log: ± UnitOffEvapWaterTmpLo String in the alarm snapshot UnitOffEvapWaterTmpLo	Water flow too low.	Increase the water flow.
	Inlet temperature to the evaporator is too low.	Increase the inlet water temperature.
	Flow switch is not working or no water flow.	Check the flow switch and the water pump.
	Sensors readings (entering or leaving) are not properly calibrated.	Check the water temperatures with a proper instrument and adjust the offsets
	Wrong freeze limit setpoint.	The freeze limit has not been changed as a function of glycol percentage.
Reset		Notes
Local HMI	<input checked="" type="checkbox"/>	It's required to check if the evaporator has any damage due to this alarm.
Network	<input checked="" type="checkbox"/>	
Auto	<input type="checkbox"/>	

### 6.3.7 External alarm

This alarm is generated to indicate that an external device whose operation is linked with this unit operation. This external device could be a pump or an inverter.

Symptom	Cause	Solution
Unit status is Off. All circuits are switched off with the normal shutdown procedure. Bell icon is moving on controller's display. String in the alarm list: UnitOffExternalAlarm String in the alarm log: ± UnitOffExternalAlarm String in the alarm snapshot UnitOffExternalAlarm	There is an external event that has caused the opening, for at least 5 seconds, of the port on the controller board.	Check causes of the external event or alarm.  Check electrical wiring from unit controller to the external equipment in case of any external events or alarms have been occurred.
Reset		Notes
Local HMI Network Auto	<input checked="" type="checkbox"/> <input checked="" type="checkbox"/> <input type="checkbox"/>	
NOTE: What above applies in case of configuration of the external fault digital input as Alarm.		

### 6.3.8 Gas Leakage Alarm

This alarm is generated when the external leak detector(s) detects a refrigerant concentration higher than a threshold. To clear this alarm is required to clear the alarm either locally and, if needed, on the leak detector itself.

Symptom	Cause	Solution
Unit status is Off. All circuits are stopped immediately. Bell icon is moving on controller's display. String in the alarm list: UnitOffGasLeakage String in the alarm log: ± UnitOffGasLeakage String in the alarm snapshot UnitOffGasLeakage	Refrigerant leakage	Locate the leakage with a sniffer and fix the leakage
	Leak detector is not properly powered	Check the power supply of the leak detector.
	Leak detector is not properly connected to the controller.	Check the connection of the detector with reference to the wiring diagram of the unit.
	Leak detector is broken	Replace the leak detector.
	Leak detector is not required/needed	Check the configuration on the unit controller and disable this option.
Reset		Notes
Local HMI Network Auto	<input checked="" type="checkbox"/> <input checked="" type="checkbox"/> <input type="checkbox"/>	

## 6.4 Circuit Events

The MicroTech™ controller can manage an event history list where various transitory conditions are stored. These conditions can automatically restore to normality but can give relevant information for maintenance and troubleshooting to prevent more serious conditions.

### 6.4.1 Low Evaporator Pressure Hold/Unload

This event indicate that the Evaporating pressure dropped below a pre-determined limit threshold so the circuit capacity is hold to prevent more dangerous conditions.

Symptom	Cause	Solution
Circuit status is Run. The compressor does not load anymore. Bell icon is moving on controller's display. String in the event list: C1 LowEvPressHold String in the alarm snapshot C1 LowEvPressHold  The compressor unloads. Bell icon is moving on controller's display. String in the event list: C1 LowEvPressUnld String in the alarm snapshot C1 LowEvPressUnld	Transitory condition like a fan staging on dry cooler	Wait until the condition is recovered by EXV control
	Refrigerant charge is low.	Check sight glass on liquid line to see if there is flash gas. Measure sub-cooling to see if the charge is correct.
	Protection limit not set to fit customer application.	Check the evaporator approach and the corresponding water temperature to evaluate the low pressure hold limit.
	High Evaporator Approach.	Clean the evaporator Check the quality of the fluid that flows into heat exchanger. Check the glycol percentage and type (ethilenic or propilenic)
	Water flow into water heat exchanger is too low.	Increase the water flow. Check that evaporator water pump is operating correctly providing the required water flow.
	Evaporating pressure transducer is not working properly.	Check the sensor for proper operation and calibrate the readings with a gauge.
	EEXV is not working correctly. It's not opening enough or it's moving in the opposite direction.	Check if pump-down can be finished for pressure limit reached; Check expansion valve movements. Check connection to the valve driver on the wiring diagram. Measure the resistance of each winding, it has to be different from 0 Ohm.
	Water temperature is low	Increase inlet water temperature. Check the low pressure safeties settings.

### 6.4.2 High Condenser Pressure Hold/Unload

This event indicate that the Condenser pressure raised above a pre-determined limit threshold so the circuit capacity is hold to prevent more dangerous conditions.

Symptom	Cause	Solution
Circuit status is Off. The compressor does not load anymore. Bell icon is moving on controller's display. String in the alarm list: C1 HiCndPressHold String in the alarm snapshot C1 HiCndPressHold  The compressor unloads. Bell icon is moving on controller's display. String in the alarm list: C1 HiCndPressUnld String in the alarm snapshot C1 HiCndPressUnld	Condenser pump may not be operating correctly	Check if the pump can run and give the required water flow.
	Dirty condenser heat exchanger	Clean the condenser heat exchanger.
	Entering water temperature at condenser is too high.	Check the cooling tower operation and settings. Check the three way valve operation and settings.
	Excessive charge of refrigerant into the unit.	Check liquid sub-cooling and suction super-heat to control indirectly the correct charge of refrigerant. If necessary recover all the refrigerant to weight the entire charge and to control if the value is in line with kg indication on unit label.
	Condensing pressure transducer could not operate properly.	Check for proper operation of the high pressure sensor.
	Wrong unit configuration (W/C units).	Check that the unit has been configured for high condenser temperature applications.

### 6.4.3 High Pressure Thermostatic Off

This event indicates that in HT application the water temperature at condenser in Heat mode get to close to the high pressure alarm limit while satisfying the temperature target. In this condition the unit is stopped.

Symptom	Cause	Solution
Unit status is Auto. String in the Event list: C1 HiPressThermoOff	This situation must be considered normal.	It's important to check the condenser outlet sensor position in case of dual units.

### 6.4.4 Failed Pumpdown

This event is generated to indicate that the circuit hadn't been able to remove all the refrigerant from the evaporator. It automatically clear as soon as the compressor stops just to be logged in the alarm history. It may not be recognized from BMS because the communication latency can give enough time for the reset. It may not even be seen on the local HMI.

Symptom	Cause	Solution
Circuit status is Off. No indications on the screen String in the alarm list: -- String in the alarm log: ± Cx FailedPumpdown String in the alarm snapshot Cx FailedPumpdown	EEXV is not closing completely, therefore there's "short-circuit" between high pressure side with low pressure side of the circuit.	Check for proper operation and full closing position of EEXV. Sight glass should not show refrigerant flow after the valve is closed. Check LED on the top of the valve, C LED should be solid green. If both LED are blinking alternately the valve motor is not properly connected.
	Evaporating pressure sensor is not working properly.	Check for proper operation of evaporating pressure sensor.
	Compressor on circuit is internally damaged with a mechanical problems for example on internal check-valve, or on internal spirals or vanes.	Check compressors on circuits.
Reset		Notes
Local HMI Network Auto	<input type="checkbox"/> <input type="checkbox"/> <input checked="" type="checkbox"/>	

## 6.5 Circuit Pumpdown Stop Alarms

### 6.5.1 Discharge Temperature Sensor fault

This alarm is generated to indicate that the sensor is not reading properly.

Symptom	Cause	Solution
Circuit status is Off. The circuit is switched off with the normal shutdown procedure. Bell icon is moving on controller's display. String in the alarm list: CxCmp1 OffDischTmpSen String in the alarm log: ± CxCmp1 OffDischTmpSen String in the alarm snapshot Cx Cmp1 OffDischTmpSen	Sensor is shorted.	Check for sensor integrity. Check correct sensors operation according information about kOhm (kΩ) range related to temperature values.
	Sensor is broken.	Check if sensor is shorted with a resistance measurement.
	Sensor is not properly connected (open).	Check for correct installation of the sensor on refrigerant circuit pipe.
		Check for absence of water or humidity on sensor electrical contacts.
	Check for correct plug-in of the electrical connectors.	
	Check for correct sensors wiring also according with electrical scheme.	
Reset		Notes
Local HMI Network Auto	<input checked="" type="checkbox"/> <input checked="" type="checkbox"/> <input type="checkbox"/>	

### 6.5.2 Liquid Temperature Sensor fault

This alarm is generated to indicate that the sensor is not reading properly.

Symptom	Cause	Solution
Circuit status is Off. The circuit is switched off with the normal shutdown procedure. Bell icon is moving on controller's display. String in the alarm list: CxCmp1 OffLiquidTempSen String in the alarm log: ± CxCmp1 OffLiquidTempSen String in the alarm snapshot CxCmp1 OffLiquidTempSen	Sensor is shorted.	Check for sensor integrity. Check correct sensors operation according information about kOhm (kΩ) range related to temperature values.
	Sensor is broken.	Check if sensor is shorted with a resistance measurement.
	Sensor is not properly connected (open).	Check for correct installation of the sensor on refrigerant circuit pipe.
		Check for absence of water or humidity on sensor electrical contacts.
Check for correct plug-in of the electrical connectors.		
	Check for correct sensors wiring also according with electrical scheme.	
Reset		Notes
Local HMI	<input checked="" type="checkbox"/>	
Network	<input checked="" type="checkbox"/>	
Auto	<input type="checkbox"/>	

### 6.5.3 Low Oil Level fault

This alarm indicates that the oil level inside the oil separator has become too low to allow for a safe operation of the compressor.

This switch may not be installed on the unit because in regular operations the oil separation is always granted.

Symptom	Cause	Solution
Circuit status is Off. The circuit is switched off with the normal shutdown procedure. Bell icon is moving on controller's display. String in the alarm list: CxCmp1 OffOilLevelLo String in the alarm log: ± CxCmp1 OffOilLevelLo String in the alarm snapshot CxCmp1 OffOilLevelLo	Oil Level switch not operating correctly.	Check the cabling between switch and controller feedback and power Check if switch operates correctly. Check if digital input of the controller operates correctly.
	Check the oil charge	Verify if there is enough oil inside the circuit.
Reset		Notes
Local HMI	<input checked="" type="checkbox"/>	
Network	<input checked="" type="checkbox"/>	
Auto	<input type="checkbox"/>	

### 6.5.4 Low Discharge Superheat fault

This alarm indicates that the unit has worked for too long with low discharge super heat.

Symptom	Cause	Solution
Circuit status is Off. The circuit is switched off with the shutdown procedure. Bell icon is moving on controller's display. String in the alarm list: CxCmp1 OffDishSHLo String in the alarm log: ± CxCmp1 OffDishSHLo String in the alarm snapshot CxCmp1 OffDishSHLo	EEXV is not working correctly. It's not opening enough or it's moving in the opposite direction.	Check if pump-down can be finished for pressure limit reached;
		Check expansion valve movements.
		Check connection to the valve driver on the wiring diagram.
		Measure the resistance of each winding, it has to be different from 0 Ohm.
Reset		Notes
Local HMI	<input checked="" type="checkbox"/>	
Network	<input checked="" type="checkbox"/>	
Auto	<input checked="" type="checkbox"/> x 2 attempts (W/C only)	

### 6.5.5 Oil Pressure Sensor fault

This alarm is generated to indicate that the sensor is not reading properly.

Symptom	Cause	Solution
Circuit status is Off. The circuit is switched off with the normal shutdown procedure. Bell icon is moving on controller's display. String in the alarm list: CxCmp1 OffOilFeedPSen String in the alarm log: ± CxCmp1 OffOilFeedPSen String in the alarm snapshot CxCmp1 OffOilFeedPSen	Sensor is broken.	Check for sensor integrity. Check correct sensors operation according information about mVolt (mV) range related to pressure values in kPa.
	Sensor is shorted.	Check if sensor is shorted with a resistance measurement.
	Sensor is not properly connected (open).	Check for correct installation of the sensor on refrigerant circuit pipe. The transducer must be able to sense the pressure through the valve's needle.
		Check for absence of water or humidity on sensor electrical contacts.
Check for correct plug-in of the electrical connectors.		
Reset		Notes
Local HMI	<input checked="" type="checkbox"/>	
Network	<input checked="" type="checkbox"/>	
Auto	<input type="checkbox"/>	

### 6.5.6 Suction Temperature Sensor fault

This alarm is generated to indicate that the sensor is not reading properly.

Symptom	Cause	Solution
Circuit status is Off. The circuit is switched off with the normal shutdown procedure. Bell icon is moving on controller's display. String in the alarm list: CxCmp1 OffSuctTempSen String in the alarm log: ± CxCmp1 OffSuctTempSen String in the alarm snapshot CxCmp1 OffSuctTempSen	Sensor is shorted.	Check for sensor integrity. Check correct sensors operation according information about kOhm (kΩ) range related to temperature values.
	Sensor is broken.	Check if sensor is shorted with a resistance measurement.
	Sensor is not good connected (open).	Check for correct installation of the sensor on refrigerant circuit pipe.
		Check for absence of water or humidity on sensor electrical contacts.
Check for correct plug-in of the electrical connectors.		
Reset		Notes
Local HMI	<input checked="" type="checkbox"/>	
Network	<input checked="" type="checkbox"/>	
Auto	<input type="checkbox"/>	

## 6.6 Circuit Rapid Stop Alarms

### 6.6.1 Compressor Extension Communication Error

This alarm is generated in case of communication problems with the CCx module.

Symptom	Cause	Solution
Circuit status is Off. All circuits are stopped immediately. Bell icon is moving on controller's display. String in the alarm list: Cx OffCmpCtrlrComFail String in the alarm log: ± Cx OffCmpCtrlrComFail String in the alarm snapshot Cx OffCmpCtrlrComFail	Module has no power supply	Check the power supply from the connector on the side of the module.
		Check if LEDs are both green.
	Check if the connector on the side is tightly inserted in the module	
	Module address is not properly set	Check if module's address is correct referring to the wiring diagram.
	Module is broken	Check if LED are on and both green. If BSP LED is solid red replace the module
		Check if power supply is ok but LEDs are both off. In this case replace the module
Reset		Notes
Local HMI	<input checked="" type="checkbox"/>	
Network	<input checked="" type="checkbox"/>	
Auto	<input type="checkbox"/>	

### 6.6.2 EXV Driver Extension Communication Error

This alarm is generated in case of communication problems with the EEXVx module.

Symptom	Cause	Solution
Circuit status is Off. All circuits are stopped immediately. Bell icon is moving on controller's display. String in the alarm list: Cx OffEXVCtrlrComFail String in the alarm log: ± Cx OffEXVCtrlrComFail String in the alarm snapshot Cx OffEXVCtrlrComFail	Module has no power supply	Check the power supply from the connector on the side of the module. Check if LEDs are both green. Check if the connector on the side is tightly inserted in the module
	Module address is not properly set	Check if module's address is correct referring to the wiring diagram.
	Module is broken	Check if LED are on and both green. If BSP LED is solid red replace the module Check if power supply is ok but LEDs are both off. In this case replace the module
		Notes
Reset		
Local HMI	<input checked="" type="checkbox"/>	
Network	<input checked="" type="checkbox"/>	
Auto	<input type="checkbox"/>	

### 6.6.3 Compressor VFD Fault

This alarm indicates an abnormal condition that forced the inverter to stop.

Symptom	Cause	Solution
Circuit status is Off. The compressor does not load anymore, circuit is immediately stopped. Bell icon is moving on controller's display. String in the alarm list: CxCmpl OffVfdFault String in the alarm log: ± CxCmpl OffVfdFault String in the alarm snapshot CxCmpl OffVfdFault	Inverter is operating in an unsafe condition and for this reason the inverter must be stopped.	Check the alarm snapshot to identify the alarm code from the inverter. Contact your service organization to get the problem solved.
Reset		Notes
Local HMI	<input checked="" type="checkbox"/>	
Network	<input checked="" type="checkbox"/>	
Auto	<input type="checkbox"/>	

### 6.6.4 Condensing Pressure sensor fault

This alarm indicates that the condensing pressure transducer is not operating properly.

Symptom	Cause	Solution
Circuit status is Off. The circuit is stopped. Bell icon is moving on controller's display. String in the alarm list: CxCmpl CondPressSen String in the alarm log: ± CxCmpl CondPressSen String in the alarm snapshot CxCmpl CondPressSen	Sensor is broken.	Check for sensor integrity. Check correct sensors operation according information about mVolt (mV) range related to pressure values in kPa.
	Sensor is shorted.	Check if sensor is shorted with a resistance measurement.
	Sensor is not properly connected (open).	Check for correct installation of the sensor on refrigerant circuit pipe. The transducer must be able to sense the pressure through the valve's needle.
		Check for absence of water or humidity on sensor electrical contacts.
		Check for correct plug-in of the electrical connectors.
		Check for correct sensors wiring also according electrical scheme.
Reset		Notes
Local HMI	<input checked="" type="checkbox"/>	
Network	<input checked="" type="checkbox"/>	
Auto	<input type="checkbox"/>	



### 6.6.5 Evaporating Pressure sensor fault

This alarm indicates that the evaporating pressure transducer is not operating properly.

Symptom	Cause	Solution
Circuit status is Off. The circuit is stopped. Bell icon is moving on controller's display. String in the alarm list: CxCmpl EvapPressSen String in the alarm log: ± CxCmpl EvapPressSen String in the alarm snapshot CxCmpl EvapPressSen	Sensor is broken.	Check for sensor integrity. Check correct sensors operation according information about mVolt (mV) range related to pressure values in kPa.
	Sensor is shorted.	Check if sensor is shorted with a resistance measurement.
	Sensor is not properly connected (open).	Check for correct installation of the sensor on refrigerant circuit pipe. The transducer must be able to sense the pressure through the valve's needle.
		Check for absence of water or humidity on sensor electrical contacts.
		Check for correct plug-in of the electrical connectors.
		Check for correct sensors wiring also according electrical scheme.
Reset		Notes
Local HMI	<input checked="" type="checkbox"/>	
Network	<input checked="" type="checkbox"/>	
Auto	<input type="checkbox"/>	

### 6.6.6 Motor Temperature Sensor Fault

This alarm indicates that the motor temperature sensor is not operating properly.

Symptom	Cause	Solution
Circuit status is Off. The circuit is stopped. Bell icon is moving on controller's display. String in the alarm list: CxCmpl OffMtrTempSen String in the alarm log: ± CxCmpl OffMtrTempSen String in the alarm snapshot CxCmpl OffMtrTempSen	Sensor is broken	Check for sensor integrity. Check correct sensors operation according information about resistance in Ohm.
	Sensor is shorted.	Check if sensor is shorted with a resistance measurement.
	Sensor is not properly connected (open).	Check for correct installation of the cabling for compressor terminal box to controller
		Check for absence of water or humidity on sensor electrical contacts.
		Check for correct plug-in of the electrical connectors.
		Check for correct sensors wiring also according electrical scheme.
Reset		Notes
Local HMI	<input checked="" type="checkbox"/>	
Network	<input checked="" type="checkbox"/>	
Auto	<input type="checkbox"/>	

### 6.6.7 EXV Driver Error

This alarm indicates an abnormal condition of the EXV Driver.

Symptom	Cause	Solution
Circuit status is Off. Circuit is immediately stopped. Bell icon is moving on controller's display. String in the alarm list: Cx OffEXVDrvError String in the alarm log: ± Cx OffEXVDrvError String in the alarm snapshot Cx OffEXVDrvError	Hardware Error	Contact your service organization to get the problem solved.
Reset		Notes
Local HMI	<input checked="" type="checkbox"/>	
Network	<input checked="" type="checkbox"/>	
Auto	<input type="checkbox"/>	

### 6.6.8 High Discharge Temperature Alarm

This alarm indicates that the temperature at the discharge port of the compressor exceeded a maximum limit which may cause damages to the mechanical parts of the compressor.



When this alarm occurs compressor's crankcase and discharge pipes may become very hot. Be careful when getting in contact with the compressor and discharge pipes in this condition.

Symptom	Cause	Solution
Circuit status is Off. The compressor does not load anymore or even unload, circuit is stopped. Bell icon is moving on controller's display. String in the alarm list: CxCmp1 OffDischTmpHi String in the alarm log: ± CxCmp1 OffDischTmpHi String in the alarm snapshot CxCmp1 OffDischTmpHi	Liquid Injection solenoid valve is not operating properly.	Check the electrical connection between the controller and the liquid injection solenoid valve. Check if the solenoid coil operates properly Check if the digital output operates correctly.
	Liquid injection orifice is small.	Check if when the liquid injection solenoid is activated the temperature can be controlled between the limits. Check that the liquid injection line is not obstructed by observing the discharge temperature when it is activated.
	Discharge temperature sensor could not operate properly.	Check for proper operation of the discharge temperature
Reset		Notes
Local HMI	<input checked="" type="checkbox"/>	
Network	<input checked="" type="checkbox"/>	
Auto	<input type="checkbox"/>	

### 6.6.9 High Motor Current Alarm

This alarm indicates that the compressor absorbed current is exceeding a predefined limit.

Symptom	Cause	Solution
Circuit status is Off. The compressor does not load anymore or even unload, circuit is stopped. Bell icon is moving on controller's display. String in the alarm list: CxCmp1 OffMtrAmpsHi String in the alarm log: ± CxCmp1 OffMtrAmpsHi String in the alarm snapshot CxCmp1 OffMtrAmpsHi	Condenser water temperature is higher than the limit set on the unit envelope (W/C units).	Check the unit selection to see if the unit can operate at full load. Check if condenser pump is operating correctly, giving enough water flow. Clean condenser water heat exchanger.
	The wrong compressor model has been selected.	Check the compressor model for this unit.
Reset		Notes
Local HMI	<input checked="" type="checkbox"/>	
Network	<input checked="" type="checkbox"/>	
Auto	<input type="checkbox"/>	

### 6.6.10 High Motor Temperature Alarm

This alarm indicates that the motor temperature has exceeded the maximum temperature limit for safe operations.

Symptom	Cause	Solution
Circuit status is Off. The compressor does not load anymore or even unload, circuit is stopped. Bell icon is moving on controller's display. String in the alarm list: CxCmp1 OffMotorTempHi String in the alarm log: ± CxCmp1 OffMotorTempHi String in the alarm snapshot CxCmp1 OffMotorTempHi	Insufficient motor cooling.	Check refrigerant charge. Check if operational envelope of the unit is respected.
	Motor temperature sensor could not operate properly.	Check the readings of the motor temperature sensor and check the Ohmic value. A correct reading should be around hundreds of Ohm at ambient temperature.
		Check the electrical connection of the sensor with the electronic board.
Reset		Notes
Local HMI	<input checked="" type="checkbox"/>	
Network	<input checked="" type="checkbox"/>	
Auto	<input type="checkbox"/>	

### 6.6.11 High Oil Pressure Differential Alarm

This alarm indicates that the oil filter is clogged and needs to be replaced.

Symptom	Cause	Solution
Circuit status is Off. The circuit is stopped. Bell icon is moving on controller's display. String in the alarm list: CxCmp1 OffOilPrDiffHi String in the alarm log: ± CxCmp1 OffOilPrDiffHi String in the alarm snapshot CxCmp1 OffOilPrDiffHi	Oil filter is clogged.	Replace oil filter.
	Oil Pressure Transducer is reading incorrectly.	Check Oil Pressure Transducer readings with a gauge.
	Condensing Pressure Transducer is reading incorrectly.	Check Condensing Pressure Transducer readings with a gauge.
Reset		Notes
Local HMI Network Auto	<input checked="" type="checkbox"/> <input checked="" type="checkbox"/> <input type="checkbox"/>	

### 6.6.12 High Pressure alarm

This alarm is generated in case the Condensing saturated temperature rise above the Maximum condensing saturated temperature and the control is not able to compensate to this condition. The maximum condenser saturated temperature is 68.5°C but it can decrease when the evaporator saturated temperature become negative.

In case of water cooled chillers operating at high condenser water temperature, if the Condensing saturated temperature exceeds the Maximum condenser saturated temperature, the circuit is only switched off without any notification on the screen as this condition is considered acceptable in this range of operation.

Symptom	Cause	Solution	
Circuit status is Off. The compressor does not load anymore or even unload, circuit is stopped. Bell icon is moving on controller's display. String in the alarm list: CxCmp1 OffCndPressHi String in the alarm log: ± CxCmp1 OffCndPressHi String in the alarm snapshot CxCmp1 OffCndPressHi	Condenser pump may not be operating correctly.	Check if the pump can run and give the required water flow.	
	Dirty condenser heat exchanger (W/C units)	Clean the condenser heat exchanger.	
	Entering water temperature at condenser is too high.		Check the cooling tower operation and settings.
			Check the three way valve operation and settings.
	Excessive charge of refrigerant into the unit.	Check liquid sub-cooling and suction super-heat to control indirectly the correct charge of refrigerant. If necessary recover all the refrigerant to weight the entire charge and to control if the value is in line with kg indication on unit label.	
	Condensing pressure transducer could not operate properly.	Check for proper operation of the high pressure sensor.	
Wrong unit configuration (W/C units).	Check that the unit has been configured for high condenser temperature applications.		
Reset		Notes	
Local HMI Network Auto	<input checked="" type="checkbox"/> <input checked="" type="checkbox"/> <input type="checkbox"/>		

### 6.6.13 Low Pressure alarm

This alarm is generated in case the evaporating pressure drops below the Low Pressure Unload and the control is not able to compensate to this condition.

Symptom	Cause		Solution
Circuit status is Off. The compressor does not load anymore or even unload, circuit is stopped immediately. Bell icon is moving on controller's display. String in the alarm list: CxCmpl OffEvpPressLo String in the alarm log: ± CxCmpl OffEvpPressLo String in the alarm snapshot CxCmpl OffEvpPressLo	Refrigerant charge is low.		Check sight glass on liquid line to see if there is flash gas. Measure sub-cooling to see if the charge is correct.
	Protection limit not set to fit customer application.		Check the evaporator approach and the corresponding water temperature to evaluate the low pressure hold limit.
	High Evaporator Approach.		Clean the evaporator
			Check the quality of the fluid that flows into heat exchanger.
			Check the glycol percentage and type (ethilenic or propilenic)
	Water flow into water heat exchanger is too low.		Increase the water flow.
			Check that evaporator water pump is operating correctly providing the required water flow.
	Evaporating pressure transducer is not working properly.		Check the sensor for proper operation and calibrate the readings with a gauge.
EEXV is not working correctly. It's not opening enough or it's moving in the opposite direction.		Check if pump-down can be finished for pressure limit reached;	
		Check expansion valve movements.	
		Check connection to the valve driver on the wiring diagram.	
		Measure the resistance of each winding, it has to be different from 0 Ohm.	
Water temperature is low		Increase inlet water temperature. Check the low pressure safeties settings.	
Reset	A/C units	W/C units	Notes
Local HMI	<input checked="" type="checkbox"/>	<input checked="" type="checkbox"/>	
Network	<input checked="" type="checkbox"/>	<input checked="" type="checkbox"/>	
Auto	<input type="checkbox"/>	<input type="checkbox"/>	

### 6.6.14 Low Pressure Ratio Alarm

This alarm indicates that the ratio between evaporating and condensing pressure is below a limit which depends on compressor speed and guarantees the proper lubrication to compressor.

Symptom	Cause		Solution
Circuit status is Off. The circuit is stopped. Bell icon is moving on controller's display. String in the alarm list: CxCmpl OffPrRatioLo String in the alarm log: ± CxCmpl OffPrRatioLo String in the alarm snapshot CxCmpl OffPrRatioLo	Compressor is not able to develop the minimum compression.		Check compressor absorbed current and discharge superheat. Compressor can be damaged.
			Check the correct operation of suction / delivery pressure sensors.
			Check the internal relief valve didn't opened during previous operation (check the unit history). Note: If the difference between delivery and suction pressure exceed 22bar, the internal relief valve open and need to be replaced.
			Inspect the gate rotors / screw rotor for possible damages.
			Check if the cooling tower or three way valves are operating correctly and properly set.
Reset			Notes
Local HMI	<input checked="" type="checkbox"/>	<input checked="" type="checkbox"/>	
Network	<input checked="" type="checkbox"/>	<input checked="" type="checkbox"/>	
Auto	<input type="checkbox"/>	<input type="checkbox"/>	

### 6.6.15 Mechanical High Pressure Alarm

This alarm is generated when the condenser pressure rises above the mechanical high pressure limit causing this device to open the power supply to all the auxiliary relays. This causes an immediate shutdown of compressor and all the other actuators in this circuit.

Symptom	Cause	Solution
Circuit status is Off. The compressor does not load anymore or even unload, circuit is stopped. Bell icon is moving on controller's display. String in the alarm list: CxCmpl OffMechPressHi String in the alarm log: ± CxCmpl OffMechPressHi String in the alarm snapshot CxCmpl OffMechPressHi	Condenser pump may not be operating correctly.	Check if the pump can run and give the required water flow.
	Dirty condenser heat exchanger.	Clean the condenser heat exchanger.
	One or more condenser fan turning in wrong direction.	Check for correct phases sequence (L1, L2, L3) in the electrical connection of the fans.
	Entering water temperature at condenser is too high.	Check the cooling tower operation and settings. Check the three way valve operation and settings.
	Mechanical high pressure switch is damaged or not calibrated.	Check for proper operation of the high pressure switch.
<b>Reset</b>		<b>Notes</b>
Local HMI <input checked="" type="checkbox"/> Network <input checked="" type="checkbox"/> Auto <input type="checkbox"/>		Reset of this alarm requires a manual action on the high pressure switch.

### 6.6.16 No Pressure At Start Alarm

This alarm is used to indicate a condition where the pressure at the evaporator or at the condenser is lower than 35kPa, so the circuit is potentially empty of refrigerant.

Symptom	Cause	Solution
Circuit status is Off. The compressor does not start Bell icon is moving on controller's display. String in the alarm list: Cx OffNoPressAtStart String in the alarm log: ± Cx OffNoPressAtStart String in the alarm snapshot Cx OffNoPressAtStart	Evaporator or condenser pressure are below 35kPa	Check transducers calibration with an appropriate gauge.
		Check transducers cabling and readout.
		Check refrigerant charge and set it to the proper value.
<b>Reset</b>		<b>Notes</b>
Local HMI <input checked="" type="checkbox"/> Network <input checked="" type="checkbox"/> Auto <input type="checkbox"/>		

### 6.6.17 No Pressure Change At Start Alarm

This alarm indicates that the compressor is not able to start or to create a certain minimum variation of the evaporating or condensing pressures after start.

Symptom	Cause	Solution
Circuit status is Off. The circuit is stopped. Bell icon is moving on controller's display. String in the alarm list: Cx OffNoPressChgStart String in the alarm log: ± Cx OffNoPressChgStart String in the alarm snapshot Cx OffNoPressChgStart	Compressor cannot start	Check if the start signal is properly connected to the inverter.
	Compressor is turning in wrong direction.	Check correct phases sequence to the compressor (L1, L2, L3) according to the electrical scheme.
	Refrigerant circuit is empty of refrigerant.	Inverter is not properly programmed with the right direction of rotation Check circuit pressure and presence of refrigerant.
	Not proper operation of evaporating or condensing pressure transducers.	Check proper operation of evaporating or condensing pressure transducers.
<b>Reset</b>		<b>Notes</b>
Local HMI <input checked="" type="checkbox"/> Network <input checked="" type="checkbox"/> Auto <input type="checkbox"/>		

### 6.6.18 Overvoltage Alarm

This alarm indicates that chiller supply voltage exceeded the maximum limit which allows proper operations of the components. This is estimated looking at the DC voltage on the inverter which depends of course from the main power.



**Resolution of this fault requires a direct intervention on the power supply of this unit.**  
**Direct intervention on the power supply can cause electrocution, burns or even death. This action must be performed only by trained persons. In case of doubts contact your maintenance company.**

Symptom	Cause	Solution
Circuit status is Off. The circuit is stopped. Bell icon is moving on controller's display. String in the alarm list: Cx OffOverVoltage String in the alarm log: ± Cx OffOverVoltage String in the alarm snapshot Cx OffOverVoltage	Chiller main power supply had an up peak which caused the trip.	Check if main power supply is within the acceptable tolerance for this chiller
Reset		Notes
Local HMI Network Auto	<input checked="" type="checkbox"/> <input checked="" type="checkbox"/> <input checked="" type="checkbox"/>	The alarm clears automatically when the voltage is reduced to an acceptable limit.

### 6.6.19 Undervoltage Alarm

This alarm indicates that chiller supply voltage exceeded the minimum limit which allows proper operations of the components.



**Resolution of this fault requires a direct intervention on the power supply of this unit.**  
**Direct intervention on the power supply can cause electrocution, burns or even death. This action must be performed only by trained persons. In case of doubts contact your maintenance company.**

Symptom	Cause	Solution
Circuit status is Off. The circuit is stopped. Bell icon is moving on controller's display. String in the alarm list: Cx OffUnderVoltage String in the alarm log: ± Cx OffUnderVoltage String in the alarm snapshot Cx OffUnderVoltage	Chiller main power supply had a down peak which caused the trip.	Check if main power supply is within the acceptable tolerance for this chiller
Reset		Notes
Local HMI Network Auto	<input checked="" type="checkbox"/> <input checked="" type="checkbox"/> <input checked="" type="checkbox"/>	The alarm clears automatically when the voltage is increased to an acceptable limit.

### 6.6.20 Motor Phase Loss

This alarm indicates a problem at the VFD output where one motor phase is missing.



**Resolution of this fault requires a direct intervention on the power supply of this unit.**  
**Direct intervention on the power supply can cause electrocution, burns or even death. This action must be performed only by trained persons. In case of doubts contact your maintenance company.**

Symptom	Cause	Solution
Circuit status is Off. The, circuit is immediately stopped. Bell icon is moving on controller's display. String in the alarm list: C1 OffMtrPhaseLoss String in the alarm log: ± C1 OffMtrPhaseLoss String in the alarm snapshot C1 OffMtrPhaseLoss	Possible damage to cables or compressor.	Contact your Service support.
Reset		Notes
Local HMI Network Auto	<input checked="" type="checkbox"/> <input checked="" type="checkbox"/> <input type="checkbox"/>	The alarm may not clear without a proper action.

### 6.6.21 Motor Earth Leakage

This alarm indicates a problem at the VFD which senses an earth leakage.



**Resolution of this fault requires a direct intervention on the power supply of this unit. Direct intervention on the power supply can cause electrocution, burns or even death. This action must be performed only by trained persons. In case of doubts contact your maintenance company.**

Symptom	Cause	Solution
Circuit status is Off. The, circuit is immediately stopped. Bell icon is moving on controller's display. String in the alarm list: C1 OffMtrEarthLkg String in the alarm log: ± C1 OffMtrEarthLkg String in the alarm snapshot C1 OffMtrEarthLkg	Possible damage to compressor.	Contact your Service support.
Reset		Notes
Local HMI Network Auto	<input checked="" type="checkbox"/> <input checked="" type="checkbox"/> <input type="checkbox"/>	The alarm may not clear without a proper action.

### 6.6.22 VFD Mains Input Phase Loss

This alarm indicates a problem at the VFD which senses an earth leakage.



**Resolution of this fault requires a direct intervention on the power supply of this unit. Direct intervention on the power supply can cause electrocution, burns or even death. This action must be performed only by trained persons. In case of doubts contact your maintenance company.**

Symptom	Cause	Solution
Circuit status is Off. The, circuit is immediately stopped. Bell icon is moving on controller's display. String in the alarm list: C1 OffMainPhaseLoss String in the alarm log: ± C1 OffMainPhaseLoss String in the alarm snapshot C1 OffMainPhaseLoss	A fuse can be blown.	Replace the fuse.
	A power cable can be interrupted	Check the power cables. Check the fuses in the power cabin.
Reset		Notes
Local HMI Network Auto	<input checked="" type="checkbox"/> <input checked="" type="checkbox"/> <input type="checkbox"/>	The alarm may not clear without a proper action.

### 6.6.23 VFD Control Card Temperature High

This alarm can indicate a problem with the VFD cooling that needs to be fixed.

Symptom	Cause	Solution
Circuit status is Off. The, circuit is immediately stopped. Bell icon is moving on controller's display. String in the alarm list: C1 OffCtrlCardTmpHi String in the alarm log: ± C1 OffCtrlCardTmpHi String in the alarm snapshot C1 OffCtrlCardTmpHi	The VFD air inlets can be obstructed	Check and clean the air inlets
	The VFD cooling fan can be broken	Check the VFD cooling fan and in case replace it.
	The VFD can be outside of its environmental condition limits	Check the operating conditions of the VFD.
Reset		Notes
Local HMI Network Auto	<input checked="" type="checkbox"/> <input checked="" type="checkbox"/> <input type="checkbox"/>	The alarm may not clear without a proper action.

### 6.6.24 VFD Communication Failure

This alarm indicates a communication problem with the inverter.

Symptom	Cause	Solution
Circuit status is Off. The compressor does not load anymore, circuit is immediately stopped. Bell icon is moving on controller's display. String in the alarm list: CxCmp1 OffVfdCommFail String in the alarm log: ± CxCmp1 OffVfdCommFail String in the alarm snapshot CxCmp1 OffVfdCommFail	RS485 network is not properly cabled.	Check the continuity of the RS485 network with the unit off. There should be continuity from the main controller to the last inverter as indicated on the wiring diagram.
	Modbus communication is not running properly.	Check inverter addresses and addresses of all the additional devices in the RS485 network (for example the energy meter). All the addresses must be different.
	Modbus interface card can be faulty	Check with your service organization to evaluate this possibility and eventually replace the board.
Reset		Notes
Local HMI Network Auto	<input checked="" type="checkbox"/> <input checked="" type="checkbox"/> <input checked="" type="checkbox"/>	The alarm clears automatically when the communication is re-established.



## 7 OPTIONS

### 7.1 Energy Meter including Current Limit (Optional)

An energy meter can be optionally installed on the unit. The energy meter is connected through Modbus to the unit controller, which can display all relevant electrical data such as:

- Line to Line Voltage (per phase and average)
- Line Current (per phase and average)
- Active Power
- Cos Phi
- Active Energy

All these data can be also accessed from a BMS by connecting it to a communication module. See the communication module manual for details on the device and parameter settings.

Both the energy meter device and the unit controller need to be properly set. The instructions below detail how to set the energy meter. Refer to the specific instructions of the energy meter for more detail on the operation of the device.

Energy Meter Settings (Nemo D4-L / Nemo D4-Le)		
Password (Down+Enter)	1000	
Connection	3-2E	three phase Aron System
Address	020	
Baud	19.2	kbps
Par	None	parity bit
Time Out	3	sec
Password 2	2001	
CT ratio	see CT label	current transformer ratio (i.e if CT is 600:5, set to 120)
VT ratio	1	no voltage transformers (unless 690V chiller)

Once the energy meter has been configured, do the following steps in the unit controller:

- From Main Menu, go to View/Set Unit → Commission Unit → Configuration → Unit
- Set Energy Mtr = Nemo D4-L or Nemo D4-Le

The energy meter option integrates the current limit function, which allows the unit to limit its capacity in order not to exceed a pre-defined current setpoint. This setpoint can be set in the unit display or can be changed from an external 4-20 mA signal.

The current limit must be set according to the following instructions:

- From Main Menu, go to View/Set Unit → Power Conservation

The following settings related to current limit option are available into the menu:

Unit Current	Displays the unit current
Current Limit	Displays the active current limit (which can be given by an external signal if unit is in network mode)
Current Lim Sp	Set the current limit setpoint (if unit is in local mode)

### 7.2 Rapid Restart (Optional)

This chiller can activate a Rapid Restart (optional) sequence in reaction to a power failure. A digital contact is used to inform the controller that the feature is enabled. The feature is configured in the factory.

Rapid restart is activated under the following conditions:

- The power failure exists for up to 180 seconds
- The unit and circuit switches are ON.
- No unit or circuit alarms exist.
- The unit has been running in the normal Run state
- The BMS Circuit Mode setpoint is set to Auto when the control source is Network

If the power failure is more than 180 seconds, the unit will start based on the setting of the Stop-to-Start cycle timer (minimum setting of 3 minutes) and load per standard unit without Rapid Restart.

When Rapid Restart is active, the unit will restart within 30 seconds of power restoration. The time to restore full load is less than 3 minutes.

*The present publication is drawn up by of information only and does not constitute an offer binding upon Daikin Applied Europe S.p.A.. Daikin Applied Europe S.p.A. has compiled the content of this publication to the best of its knowledge. No express or implied warranty is given for the completeness, accuracy, reliability or fitness for particular purpose of its content, and the products and services presented therein. Specifications are subject to change without prior notice. Refer to the data communicated at the time of the order. Daikin Applied Europe S.p.A. explicitly rejects any liability for any direct or indirect damage, in the broadest sense, arising from or related to the use and/or interpretation of this publication. All content is copyrighted by Daikin Applied Europe S.p.A..*

**DAIKIN APPLIED EUROPE S.p.A.**

Via Piani di Santa Maria, 72 - 00072 Ariccia (Roma) - Italia  
Tel: (+39) 06 93 73 11 - Fax: (+39) 06 93 74 014  
<http://www.daikinapplied.eu>