



Public

REV	06
Date	12/2024
Supersedes	D-EOMHP01505-22_05EN

**Operating Manual
D-EOMHP01505-22_06EN**

**Air to water heat pump units with scroll compressors
split version**

EWYT~CZI / EWYT~CZO

Contents

1. SAFETY CONSIDERATIONS	4
1.1. General	4
1.2. Before switching the unit	4
1.3. Avoid electrocution	4
2. GENERAL DESCRIPTION	5
2.1. Basic Information	5
2.2. Abbreviations used	5
2.3. Controller Operating Limits	5
2.4. Controller Architecture	5
2.5. Controller maintenance	5
2.6. Embedded Web Interface (Optional)	6
2.7. Application Save and Reset	6
3. WORKING WITH THIS UNIT	7
3.1. Unit Interface	7
3.1.1. Icons Description	8
3.2. 8	
3.3. Insert Password	9
3.4. Chiller On/Off	9
3.4.1. Keypad On/Off	9
3.4.2. Scheduler	9
3.4.3. Network On/Off	11
3.4.4. Unit On/Off Switch	11
3.5. Silent Mode	12
3.6. Water Setpoints	12
3.7. Unit Mode	13
3.7.1. Heat/Cool set-up	13
3.7.1.1. Cooling-Heating mode by Digital input	14
3.7.1.2. Cooling-Heating mode by Software parameter	14
3.8. Pumps and Variable Flow	14
3.8.1. Fixed Speed	14
3.8.2. Variable Primary Flow (VPF)	14
3.8.3. DeltaT	15
3.9. Network Control	15
3.10. Thermostatic Control	16
3.11. External Alarm	17
3.12. Unit Capacity	17
3.13. Power Conservation	18
3.13.1. Demand Limit	18
3.13.2. Current Limit	18
3.13.3. Setpoint Reset	19
3.13.3.1. Setpoint Reset by OAT	19
3.13.3.2. Setpoint Reset by 0-10V signal	20
3.13.3.3. Setpoint Reset by DT	21
3.14. Controller IP Setup	21
3.15. Daikin On Site	22
3.16. Date/Time	22
3.17. Master/Slave	23
3.18. Unit Boost	23
3.19. Fan Boost	24
3.20. Costant Heating Capacity	24
3.21. Domestic Hot Water	24
3.22. Customer Unit Configuration	25
3.23. Connectivity Kit & BMS Connection	26
3.24. About Chiller	27
3.25. HMI Screen Saver	27
3.26. Generic Controller Operation	27
3.27. BEG – SG Ready & Energy Monitoring	28
3.28. EKDAGBL - Restricted Application Definer	29
3.29. HMI Parameters Navigation Table	29
4. ALARMS AND TROUBLE SHOOTING	33
4.1. Alarms List: Overview	33
4.2. Troubleshooting	36

List of graphs

<i>Graph 1</i> – Compressors start-up sequence - Cool mode.....	16
<i>Graph 2</i> – Demand Limit[V] vs Capacity Limit [%].....	18
<i>Graph 3</i> – Outside Ambient Temperature vs Active Setpoint - Cooling mode(left)/ Heating mode(right)	20
<i>Graph 4</i> – External signal 0-10V vs Active Setpoint - Cooling mode(left)/ Heating mode(right)	20
<i>Graph 5</i> – Evap ΔT vs Active Setpoint - Cooling mode(left)/ Heating mode(right)	21

1. SAFETY CONSIDERATIONS

1.1. General

Installation, start-up and servicing of equipment can be hazardous if certain factors particular to the installation are not considered: operating pressures, presence of electrical components and voltages and the installation site (elevated plinths and built-up up structures). Only properly qualified installation engineers and highly qualified installers and technicians, fully trained for the product, are authorized to install and start-up the equipment safely.

During all servicing operations, all instructions and recommendations, which appear in the installation and service instructions for the product, as well as on tags and labels fixed to the equipment and components and accompanying parts supplied separately, must be read, understood and followed.

Apply all standard safety codes and practices.

Wear safety glasses and gloves.



The emergency stop causes all motors to stop but does not switch off power to the unit. Do not service or operate on the unit without having switched off the main switch.

1.2. Before switching the unit

Before switching on the unit read the following recommendations:

- When all the operations and all the settings have been carried out, close all the switchbox panels
- The switchbox panels can only be opened by trained personnel
- When the UC requires to be accessed frequently the installation of a remote interface is strongly recommended
- LCD display of the unit controller may be damaged by extremely low temperatures. For this reason, it is strongly recommended to never power off the unit during winter, especially in cold climates.

1.3. Avoid electrocution

Only personnel qualified in accordance with IEC (International Electrotechnical Commission) recommendations may be permitted access to electrical components. It is particularly recommended that all sources of electricity to the unit be shut off before any work is begun. Shut off main power supply at the main circuit breaker or isolator.

IMPORTANT: This equipment uses and emits electromagnetic signals. Tests have shown that the equipment conforms to all applicable codes with respect to electromagnetic compatibility.



Direct intervention on the power supply can cause electrocution, burns or even death. This action must be performed only by trained persons.



RISK OF ELECTROCUTION: Even when the main circuit breaker or isolator is switched off, certain circuits may still be energized, since they may be connected to a separate power source.



RISK OF BURNS: Electrical currents cause components to get hot either temporarily or permanently. Handle power cable, electrical cables and conduits, terminal box covers and motor frames with great care.



In accordance with the operating conditions the fans can be cleaned periodically. A fan can start at any time, even if the unit has been shut down.

2. GENERAL DESCRIPTION

2.1. Basic Information

POL468.85/MCQ/MCQ is a system for controlling single or dual-circuit air cooled chillers. POL468.85/MCQ/MCQ controls compressor start-up necessary to maintain the desired heat exchanger leaving water temperature. In each unit mode it controls the operation of the condensers to maintain the proper condensation process in each circuit. Safety devices are constantly monitored by POL468.85/MCQ/MCQ to ensure their safe operation.

2.2. Abbreviations used

In this manual, the refrigeration circuits are called circuit #1 and circuit #2. The compressor in circuit #1 is labelled Cmp1. The other in circuit #2 is labelled Cmp2. The following abbreviations are used:

A/C	Air Cooled	ESRT	Evaporating Saturated Refrigerant Temperature
CP	Condensing Pressure	EXV	Electronic Expansion Valve
CSRT	Condensing Saturated Refrigerant Temperature	HMI	Human Machine Interface
DSH	Discharge Superheat	MOP	Maximum operating pressure
DT	Discharge Temperature	SSH	Suction Super-Heat
EEWT	Evaporator Entering Water Temperature	ST	Suction Temperature
ELWT	Evaporator Leaving Water Temperature	UC	Unit controller (POL468.85/MCQ/MCQ)
EP	Evaporating Pressure	R/W	Readable/Writable

2.3. Controller Operating Limits

Operation (IEC 721-3-3):

- Temperature -40...+70 °C
- Humidity < 95 % r.h (no condensation)
- Air pressure min. 700 hPa, corresponding to max. 3,000 m above sea level

Transport (IEC 721-3-2):

- Temperature -40...+70 °C
- Humidity < 95 % r.h (no condensation)
- Air pressure min. 260 hPa, corresponding to max. 10,000 m above sea level.

2.4. Controller Architecture

The overall controller architecture is the following:

- One POL468.85/MCQ main controller in indoor unit
- One POL468.85/MCQ controller connected via serial communication used as I/O extension of the main controller and for internal logic management.

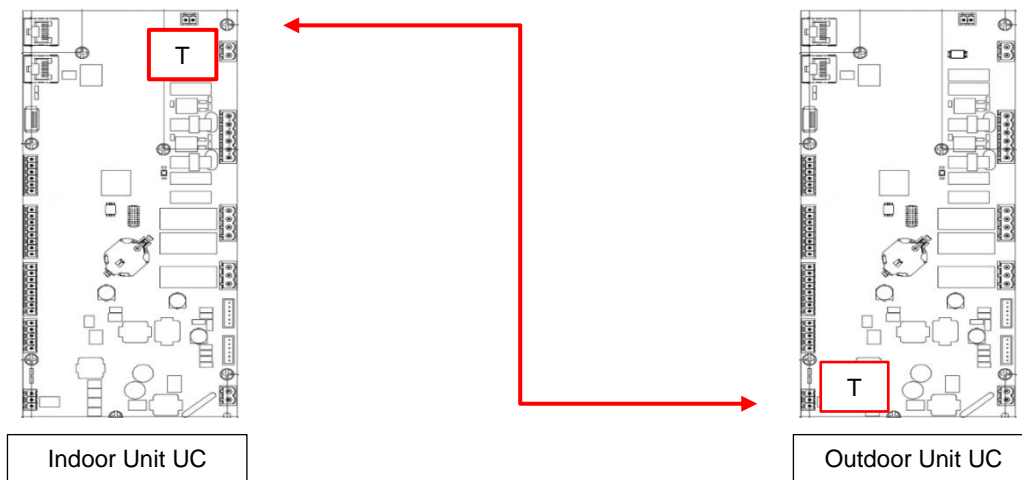

NB

Once connection has been established and both units are powered, all unit functionalities can be controlled by indoor unit UC.

2.5. Controller maintenance

The controller requires to maintain the installed battery. Every two years it's required to replace the battery. Battery model is: BR2032 and it is produced by many different vendors.



To replace the battery, it is important to remove the power supply to all unit.

Refer to picture below for battery installation.

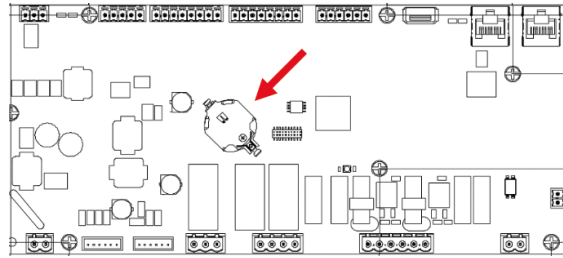

2.6. Embedded Web Interface (Optional)

The POL468.85/MCQ/MCQ controller has an embedded web interface, available with accessory EKRSCBMS (Connectivity for external BMS communication), that can be used to monitor the unit when connected to a TCP-IP network. It is possible to configure the IP addressing of the POL468.85/MCQ as a fixed IP or DHCP depending on the network configuration.

With a common web browser, a PC can connect with the unit controller entering the IP address.

When connected, it will be required to enter a username and a password. Enter the following credential to get access to the web interface:

User Name: ADMIN

Password: SBTAdmin!

2.7. Application Save and Reset

Every variation of the HMI parameters will be lost after a power loss and it's necessary to execute a saving command to make them permanent. This action can be done via the Application Save command.

The controller automatically makes an Application Save after a change of value of one of following parameters:

Parameters	Name
1.00	Unit Enable
1.01	Circuit 1 Enable
1.02	Circuit 2 Enable
2.00	Available Modes
4.00	Control Source
5.00	Cool Setpoint 1
5.01	Cool Setpoint 2
5.02	Heat Setpoint 1
5.03	Heat Setpoint 2
13.00	DHCP Enable
15.00	Unit Boost
15.01	Fan Boost
15.08	Silent Fan Speed
18.00	Demand Limit Enable
18.01	Current Limit
22.15	Bas Protocol



Some parameters present in the interface require a restart of the UC to become effective after a change of value. This operation can be done using the Apply Changes command.

These commands can be found in Page [23]:

Menu	Parameter	R/W
23	00 (Application Save)	W
(PLC)	01(Apply Changes)	W

The path in the Web HMI interface for Application Save is "Main Menu".The path in the Web HMI interface for Apply Changes is "Main Menu → View/Set Unit → Controller IP Setup → Settings".

3. WORKING WITH THIS UNIT

3.1. Unit Interface

The user interface installed in the unit is divided into **4 functional groups**:

1. Numeric value Display (f.g.1)

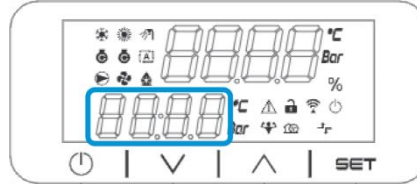

2. Actual Parameter/Sub-Parameter group (f.g.2)

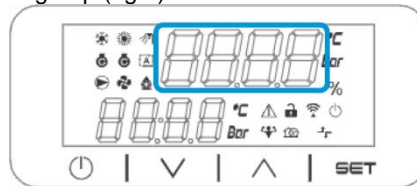

3. Icon indicators (f.g.3)

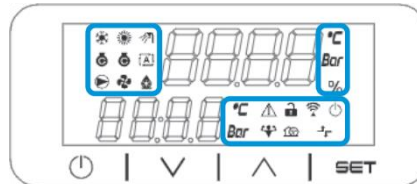

4. Menu/Navigation keys (f.g.4)

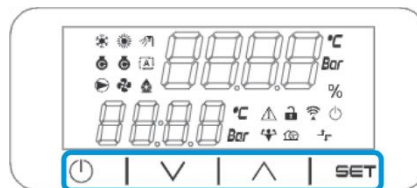

The interface has a multi-level structure divided as follows:

Main Menu	Parameters	Sub-Parameters
Page [1]	Parameter [1.00]	Sub-Parameter [1.0.0]
		...
	Parameter [1.XX]	Sub-Parameter [1.XX.0]
		...
Page [2]	Parameter [2.00]	Sub-Parameter [2.0.0]
		...
	Parameter [2.XX]	Sub-Parameter [2.XX.0]
		...
Page [N]	Parameter [N.00]	Sub-Parameter [N.00.0]
		...
	Parameter [N.XX]	Sub-Parameter [N.00.0]
		...

Parameters can be writable, only readable or give access to other sub-parameters (see table in [3.22](#) chapter).















The list of actions for browsing through the menu is:

1. Press [▲] [▼], in the navigation keys, to browse through the parameter groups, that is shown in (f.g.2) by its number, and in (f.g.1) by its name.
2. Press [SET] to select a parameter group.
3. Press [▲] [▼] to browse through the parameters in the specific group or menu.
4. Press [SET] to start value setting phase.
 - a. During this phase, the value string (f.g.1) of the HMI will start to blink
5. Press [▲] [▼] to set/change the parameter value, that is shown in the numeric display (f.g.1).
6. Press [SET] to accept the value.
 - a. After exiting the setting phase, the value string of the HMI will stop to blink. If an unavailable value is selected the value will continue to blink and value won't be set.

In order to go back through the pages, press the On/Stand-by button .

3.1.1. Icons Description

Icons provide an indication about current unit status.

ICON	Description	LED ON	LED OFF	LED BLINKING
	LED Functioning mode Chiller	Running in cooling mode	-	-
	LED Functioning mode Heat Pump	-	Running in heat mode	-
	LED Domestic Hot Water	Domestic Hot Water function ON	Domestic Hot Water function OFF	-
	LED Compressor ON (Circuit 1 Left, Circuit 2 Right)	Compressor ON	Compressor OFF	Compressor performing preopen or pump-down procedure
	LED Circulation Pump ON	Pump ON	Pump OFF	-
	LED Fan ON	Fan Stage > 0 (At least 1 fan on)	Fan Stage = 0 (All fans off)	-
	LED Defrost ON	Defrost Function ON	-	-
°C	LED Temperature	Temperature Value displayed	-	-
Bar	LED Pressure	Pressure Value displayed	-	-
%	LED Percentage	Percentage Value displayed	-	-
	LED Alarm	-	No Alarm	Alarm Presence
	LED Setting mode	Customer parameter unlocked	-	-
	LED Connection status on Daikin on site	Connected	No Connection	Requesting Connection
	LED on/stand-by	Unit Enabled	Unit Disabled	-
	LED Boost mode	Boost Mode ON	Boost Mode OFF	-
	LED Silent Mode	Silent Mode ON	Silent Mode OFF	-
	LED remote BMS control	BMS control ON	BMS control OFF	-

3.2.

3.3. Insert Password

In order to unlock customer functionalities, the User has to insert the Password through the HMI menu [0]:

Menu	Parameter	Range	Description	R/W
00	00 (Insert Password)	0-9999	To insert all the 4 digits of the password, press “Set” after the insertion of the number to move on the next digit.	W

The password to access the customer’ setting pages is: **2526**

3.4. Chiller On/Off

Unit controller provides several features to manage unit start/stop:

1. Keypad On/Off
2. Scheduler (Time programmed On/Off)
3. Network On/Off (optional with Accessory EKRSCBMS)
4. Unit On/Off Switch

3.4.1. Keypad On/Off

Keypad On/Off allows to enable or disable the unit from local controller. If needed, single refrigerant circuit can be also enabled or disabled. By default, all refrigerant circuits are enabled.

Menu	Parameter	Range	Description	R/W	
01	00 (Unit Enable)	0-2	0 = Unit disabled	W	
			1 = Unit enabled	W	
			2 = Unit enabling state based on Scheduler programming. Refer to chapter 3.3.2	W	
	01 (Circuit Enable)	1	0-1	0 = Circuit 1 disabled	W
				1 = Circuit 1 enabled	W
	02 (Circuit enable)	2	0-1	0 = Circuit 2 disabled	W
1 = Circuit 2 enabled				W	

The path in the Web HMI interface is “**Main Menu → Unit Enable**”.

3.4.2. Scheduler

The activation / deactivation of the unit can be managed automatically through the Schedule function, activated when the Unit Enable parameter is set to Schedule.

The operating modes during the different daily time bands are managed through the interface page [17] containing the following registers to be set:

Menu	Page	Parameter	R/W	Psw
[17] = Scheduler (Scheduler)	[17.00] = Monday (Monday)	[17.0.0] Time 1	W	1
		[17.0.1] Value 1	W	1
		[17.0.2] Time 2	W	1
		[17.0.3] Value 2	W	1
		[17.0.4] Time 3	W	1
		[17.0.5] Value 3	W	1
		[17.0.6] Time 4	W	1
	[17.01] = Tuesday (Tuesday)	[17.0.7] Value 4	W	1
		[17.1.0] Time 1	W	1
		[17.1.1] Value 1	W	1
		[17.1.2] Time 2	W	1
		[17.1.3] Value 2	W	1
		[17.1.4] Time 3	W	1
		[17.1.5] Value 3	W	1
	[17.02] = Wednesday	[17.1.6] Time 4	W	1
		[17.1.7] Value 4	W	1
		[17.2.0] Time 1	W	1
		[17.2.1] Value 1	W	1
		[17.2.2] Time 2	W	1
		[17.2.3] Value 2	W	1

	(Wednesday)	[17.2.4] Time 3	W	1
		[17.2.5] Value 3	W	1
		[17.2.6] Time 4	W	1
		[17.2.7] Value 4	W	1
	(Thursday) [17.03] = Thursday	[17.3.0] Time 1	W	1
		[17.3.1] Value 1	W	1
		[17.3.2] Time 2	W	1
		[17.3.3] Value 2	W	1
		[17.3.4] Time 3	W	1
		[17.3.5] Value 3	W	1
		[17.3.6] Time 4	W	1
	(Friday) [17.04] = Friday	[17.4.0] Time 1	W	1
		[17.4.1] Value 1	W	1
		[17.4.2] Time 2	W	1
		[17.4.3] Value 2	W	1
		[17.4.4] Time 3	W	1
		[17.4.5] Value 3	W	1
		[17.4.6] Time 4	W	1
	(Saturday) [17.05] = Saturday	[17.5.0] Time 1	W	1
		[17.5.1] Value 1	W	1
		[17.5.2] Time 2	W	1
		[17.5.3] Value 2	W	1
		[17.5.4] Time 3	W	1
		[17.5.5] Value 3	W	1
		[17.5.6] Time 4	W	1
	(Sunday) [17.06] = Sunday	[17.6.0] Time 1	W	1
		[17.6.1] Value 1	W	1
		[17.6.2] Time 2	W	1
[17.6.3] Value 2		W	1	
[17.6.4] Time 3		W	1	
[17.6.5] Value 3		W	1	
[17.6.6] Time 4		W	1	
		[17.6.7] Value 4	W	1

The path in the Web HMI interface is “**Main Menu → View/Set Unit → Scheduler**”.

The user can indicate four time slots for each day of the week and set one of the following modes for each of them:

Parameter	Range	Description
Value [17.x.x]	0 = Off	Unit disabled
	1 = On 1	Unit enabled – Water primary setpoint selected
	2 = On 2	Unit enabled – Water secondary setpoint selected
	3 = Silent 1	Unit enabled – Water primary setpoint selected – Fan maximum speed decreased to Silent Max Speed
	4 = Silent 2	Unit enabled – Water secondary setpoint selected – Fan maximum speed decreased to Silent Max Speed

When Fan Silent Mode function is enabled the chiller noise level is reduced decreasing the maximum speed allowed for fans according to Fan Silent Speed setpoint (see 0 Chapter for more details).

The Time slots can be set from in “Hour:Minute”:

Parameter	Range	Description
Time [17.x.x]	“00:00-24:60”	Time of the day can vary from 00:00 to 23:59. If Hour = 24 the HMI will display “An:Minute” as string and the Value# related to Time# is set for all hours of the associated day. If Minute = 60 the HMI will display “Hour:An” as string and the Value# related to Time# is set for all minutes of the selected hours of the day.

3.4.3. Network On/Off

Chiller On/Off can be managed also with BACnet or Modbus RTU communication protocol. To control the unit over the network, follow below instructions:

1. Unit On/Off switch = closed
2. Unit Enable = Enable (refer to 3.4.1)
3. Control Source = 1 (refer to 3.9)

The HMI menu is:

Menu	Parameter	Range	R/W
04	00 (Control Source)	Off = Local	W
		On = Network	W

Modbus RTU is available as default protocol on RS485 port. The HMI page [22] is used to change between Modbus and BACnet protocol and set parameters for both MSTP and TCP-IP communication, as shown in chapter 3.23.

The path in the Web HMI interface for Network Control Source is **"Main Menu View/Set → Unit → Network Control"**.

3.4.4. Unit On/Off Switch

For unit start up is mandatory to close the electrical contact between terminals: XD-703 → UC-D1 (UNIT ON/OFF SWITCH).

This short circuit can be realized through:

- External electrical switch
- Cable

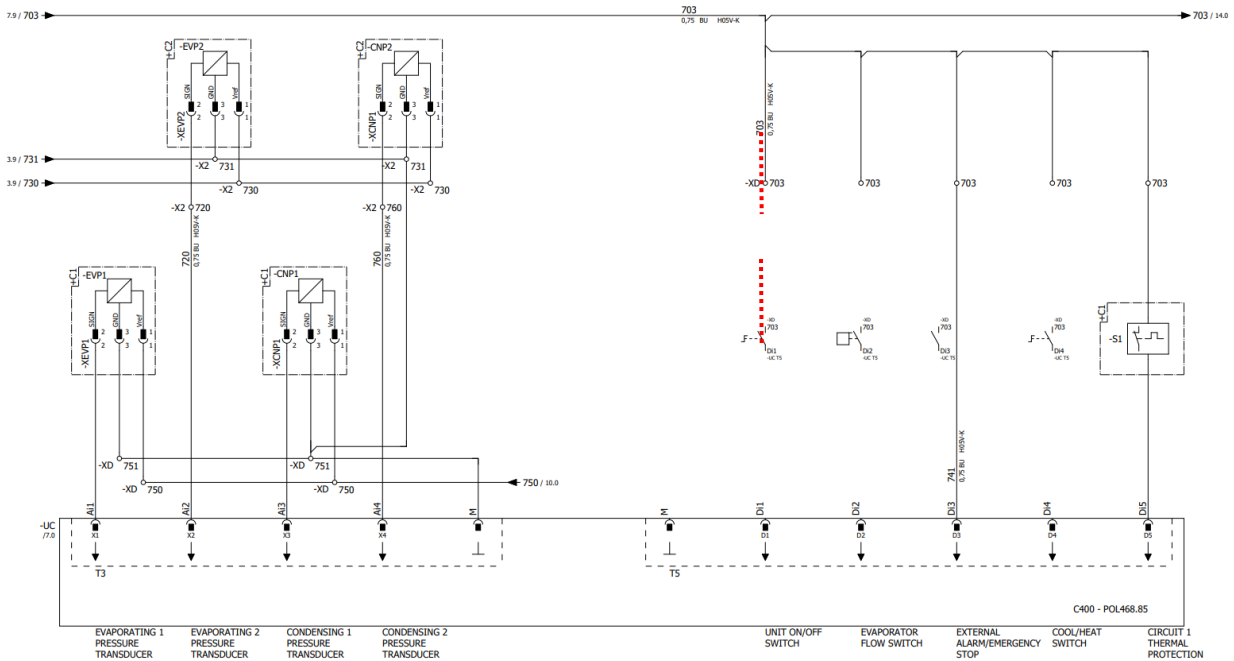

3.5. Silent Mode

Silent mode can be enabled through scheduler or network control.

If the unit is set in “**silent mode**” the maximum speed of fans is reduced according to “Fan Silent Speed” parameter for both chiller and heat pump mode.

Menu	Parameter	Range	Description	R/W	Psw
15 (Customer Configuration)	08 (Silent Fan Speed)	500-900	This parameter sets the fan speed in rpm during silent mode. Default value for Fan Silent Speed is 650rpm.	W	1

The path in the Web HMI interface for Fan Silent Speed configuration is “**Main Menu → Commission Unit → Options → silent Fan Speed**”.

Notice that, regardless “Fan Silent Mode” enabling the fan speed will be increased in critical operating conditions like high condensation, high inverters’ fin temperature, etc to prevent alarms or unit damaging.

3.6. Water Setpoints

Purpose of this unit is to cool or to heat (in case of heat pump version) the water, to the setpoint value defined by the user and displayed in the main page:

The unit can work with a primary or a secondary setpoint, that can be managed as indicated below:

1. Keypad selection + Double Setpoint digital contact
2. Keypad selection + Scheduler Configuration
3. Network
4. Setpoint Reset function

As first step the primary and secondary setpoints need to be defined.

Menu	Parameter	Range	Description	R/W
05	00 (Cool LWT 1)	-15°C ... 28°C	Primary cooling setpoint.	W
	01 (Cool LWT 2)	-15°C ... 28°C	Secondary cooling setpoint.	W
	02 (Heat LWT 1)	20°C ... 60°C	Primary heating setpoint.	W
	03 (Heat LWT 1)	20°C ... 60°C	Secondary heating setpoint.	W

The change between primary and secondary setpoint can be performed using the **Double setpoint** contact, available with accessory EKRSCBMS, or through the **Scheduler** function.

Double setpoint contact works as below:

- Contact opened, the primary setpoint is selected
- Contact closed, the secondary setpoint is selected

In order to change between primary and secondary setpoint with the Scheduler function, refer to the section [3.4.2](#).



When the scheduler function is enabled, the Double setpoint contact is ignored.



Based on the ambient temperature which unit is operating, maximum or minimum leaving water temperature will be automatically controlled to maintain the unit in the proper envelope.

To modify the active setpoint through network connection, refer to “Network control” section [3.9](#).

The active setpoint can be further modified using the “Setpoint Reset” function as explained in section [3.13.3](#).

The path in the Web HMI interface for Water Setpoint configuration is “**Main Menu → Setpoint**”.

Menu	Parameter	Description
02	01 (Mode Source)	0 = Cooling-Heating operation is defined following software parameter 1 = Cooling-Heating operation is defined following the status of digital input

To control the operating mode through the **Network Control** refer to section [3.9](#).

All settings related to Cooling-Heating operation will produce a real mode change only if Unit Mode parameter (refer to menu 01) is set to:

- Heat/Cool
 - Heat/Cool w/Glycol
- In all other cases no mode switch will be allowed

Menu	Parameter	Range	Description
02	00 (Unit Mode)	0 = Cool	Only cooling mode is permitted
		1 = Cool with glycol	
		2 = Cool / Heat	Both heating and cooling mode is permitted
		3 = Cool / Heat with glycol	

The path in the Web HMI interface for Mode Source configuration is “Main Menu → Unit Mode → CH_HP_Source”.

3.7. Unit Mode

The Unit Mode is used to define if the chiller is configured to produce chilled or heated water. This parameter is related to the unit type and is set in factory or during commissioning operation. Current mode is reported in the main page.

Menu	Parameter	Range	Description
02	00 (Unit Mode)	0 = Cool	Set if chilled water temperature down to 4°C is required.
		1 = NOT USED	-
		2 = Cool / Heat	Set in case a dual cool/heat mode is required. This setting implies an operation with double functioning which is activated through the physical switch or BMS control. <ul style="list-style-type: none"> • COOL: The unit will work in cooling mode with the Cool LWT as the Active Setpoint. • HEAT: The unit will work in heat pump mode with the Heat LWT as the Active Setpoint.
		3 = NOT USED	-



In order to have a properly configured unit check following settings:

- If EWYT → [02.00] = 2

3.7.1. Heat/Cool set-up

Heat/Cool operating mode can be set using three different methods:

1. Digital input
2. Software parameter
3. Network control

In the Page [2] is possible to define the required method between Digital Input and Software Parameter.

Menu	Parameter	Description
02	01 (Mode Source)	0 = Cooling-Heating operation is defined following software parameter
		1 = Cooling-Heating operation is defined following the status of digital input

To control the operating mode through the **Network Control** refer to section 3.9

All settings related to Cooling-Heating operation will produce a real mode change only if Unit Mode parameter (refer to menu 01) is set to:

- Heat/Cool

In all other cases no mode switch will be allowed

Menu	Parameter	Range	Description
02	00 (Unit Mode)	0 = Cool	Only cooling mode is permitted
		1 = NOT USED	
		2 = Cool / Heat	Both heating and cooling mode is permitted
		3 = NOT USED	

The path in the Web HMI interface for Mode Source configuration is “Main Menu → Unit Mode → CH_HP_Source”.

3.7.1.1. Cooling-Heating mode by Digital input

When Digital input is selected as control method for cooling-heating switch, unit mode will be set according following table

Digital input reference	Digital input state	Description
Cool/Heat switch	Opened	Cooling mode is selected
	Closed	Heating mode is selected

3.7.1.2. Cooling-Heating mode by Software parameter

When Software Parameter is selected, as control method for cooling-heating switch and parameter 2.00 is set equal to 2 or 3, unit mode will be set according following table

Menu	Parameter	Description
02	02 (UCoolHeatSw)	Off = Cool Mode On = Heat Mode

The path in the Web HMI interface for UCoolHeatSw configuration is "Main Menu → Unit Mode → UCoolHeatSw".

3.8. Pumps and Variable Flow

The UC can manage one water pump connected to the water plate heat exchanger. The pump control type is configured in page [15] and can operate in three different ways:

1. Fixed Speed
2. Variable Primary Flow (VPF)
3. DeltaT

Menu	Parameter	Description	R/W	Psw
15 (Customer Configuration)	03 (Pump Ctrl Type)	0 = On- Off 1 = Fixed Speed 2 = VPF 3 = DeltaT	W	1

The path in the Web HMI interface for Pump Ctrl Type is "Main Menu → Commission Unit → Configuration → Options → Pump Type".

3.8.1. Fixed Speed

First control mode, Fixed Speed, allows an automatic pump speed variation, between three different speed.

Settings:

1. Speed 1
2. Speed 2
3. Standby Speed

Unit controller switches the pump frequency on the basis of:

1. Actual unit capacity
2. Double Speed digital input state

If there are no active compressors (Unit Capacity = 0%) pump speed is set to Standby Speed, otherwise Speed 1 or Speed 2 is selected depending on the Double Speed input state.

3.8.2. Variable Primary Flow (VPF)

The second control mode is the VPF mode where the pump speed is controlled in order to maintain a minimum pressure drop in a remote location of the plant at a setpoint value determined to ensure the required chilled flow through any terminals or coils. When the system is enabled, unit controller reads the Load Pressure Drop at further terminal and provides a 0-10V signal as reference for variable speed drive.

Control signal is generated by a PI algorithm, and it is always limited between a minimum and maximum value set by default to 0% and 100% while the Bypass 2 way valve is installed on a pipe near to the pumps in order to ensure a minimum evaporator water flow.

The VPF control mode is regulated by following settings:

- LoadPD Setpoint
- EvapPD Setpoint
- LoadPD
- EvapPD
- Parameter Ti

3.8.3. DeltaT

The third control mode is the DeltaT mode where the pump speed is modulated through a PID to ensure a constant difference between Evaporator Entering Water Temperature and Evaporator Leaving Water Temperature.

This mode is regulated by following setting:

- DeltaT

All settings related to pump management are available in the menu [8].

Menu	Parameter	Range	Description	R/W	Psw
08	00 (Recirculation time)	0-300	Minimum time required within flow switch has to be closed to allow unit startup.	W	1
	01 (Standby Speed)	0-100	Pump speed with Unit Capacity = 0	W	1
	02 (Speed)	0-100	Actual feedback pump speed.	R	1
	03 (Max Speed)	0-100	Maximum value for pump speed.	W	1
	04 (Min Speed)	0-100	Minimum value for pump speed.	W	1
	05 (Sp Speed1)	0-100	First target value for pump speed in Fixed Speed control conditions.	W	1
	06 (Sp Speed2)	0-100	Second target value for pump speed under Fixed Speed control conditions.	W	1
	07 (Setpoint kPa1)	0-45	DeltaP target for the farthest terminal of the system.	W	1
	08 (Setpoint kPa2)	0-45	Minimum allowed value for the Evaporator Pressure Drop.	W	1
	09 (BypassValveSt)	Off/On	Off = Evaporator Pressure Drop > Minimum Evaporator Pressure Drop Setpoint + Hysteresis. On = Evaporator Pressure Drop < Minimum Evaporator Pressure Drop Setpoint.	R	1
	10 (LoadPD)	0-1000	This value displays the actual pressure across the furthest Terminal.	R	1
	11 (EvapPD)	0-1000	This value displays the actual pressure drop across the Evaporator.	R	1
	12 (Parameter-K)	1-10	This value scales the PI algorithm parameters to obtain a faster response.	W	1
	13 (Setpoint DeltaT)	0-10	Evaporator Water Temperature difference setpoint.	W	1
	14 (VPF Alarm Code)	0-3	VPF's alarming related to pressure drop sensors.	R	1
	15 (Sensor Scale)	0-2000	VPF's load pressure difference sensor scale.	W	1
16 (Pump On Limit)	(Evaporator Freeze -1) - 10	Define the pump's activation limit in case of low water temperature at the exchanger.	W	1	

The path in the Web HMI interface for Pump Settings is "Main Menu → View/Set Unit → Pumps".

3.9. Network Control

To allow unit's control from BMS system the Control Source parameter [4.00] needs to be set in Network. All settings related to BSM control communication can be visualized in Page [4]:

Menu	Parameter	Range	Description	R/W	
04	00 (Control Source)	0-1	0 = Network control disabled	On/Off command from network	W
			1 = Network control enabled		
	01 (Enable)	0-1	0 = Unit is Enable	On/Off command from network visualization	R
			1 = Unit is Disabled		
	02 (Cool LWT)	0..30°C	-	Cooling water temperature setpoint from network	R
03 (Heat LWT)	30..60°C	-	Heating water temperature setpoint from network	R	
04	0-3	0 = Not Used	Operating mode from network	R	

	(Mode)		1 = Chiller 2 = Heat Pump 3 = Not Used		
	05 (Current Limit)	mA	-	Current limitation setpoint from network	R
	06 (Capacity Limit)	0..100%	-	Capacity limitation level from network	R

Refer to communication protocol documentation for specific registers addresses and the related read/write access level.

The path in the Web HMI interface is “Main Menu → View/Set Unit → Network Control”.

3.10. Thermostatic Control

Thermostatic control settings allow to set up the response to temperature variations. Default settings are valid for most application, however plant specific conditions may require adjustments to have a smooth control or a quicker response of the unit.

The unit controller will start the first compressor if the controlled temperature is higher (Cool Mode) or lower (Heat Mode) than the active setpoint of at least a Start Up DT value, whereas second compressor when available is started if the controlled temperature is higher (Cool Mode) or lower (Heat Mode) than the active setpoint (AS) of at least a Stage Up DT (SU) value. Compressors stop if performed following same procedure looking to the parameters Stage Down DT and Shut Down DT.

		Cool Mode	Heat Mode
First start	compressor	Controlled Temperature > Setpoint + Start Up DT	Controlled Temperature < Setpoint - Start Up DT
Other start	compressors	Controlled Temperature > Setpoint + Stage Up DT	Controlled Temperature < Setpoint - Stage Up DT
Last stop	compressor	Controlled Temperature < Setpoint - Shut Dn DT	Controlled Temperature > Setpoint + Shut Dn DT
Other stop	compressors	Controlled Temperature < Setpoint - Stage Dn DT	Controlled Temperature > Setpoint + Stage Dn DT

A qualitative example of compressors start-up sequence in cool mode operation is shown in the graph below.

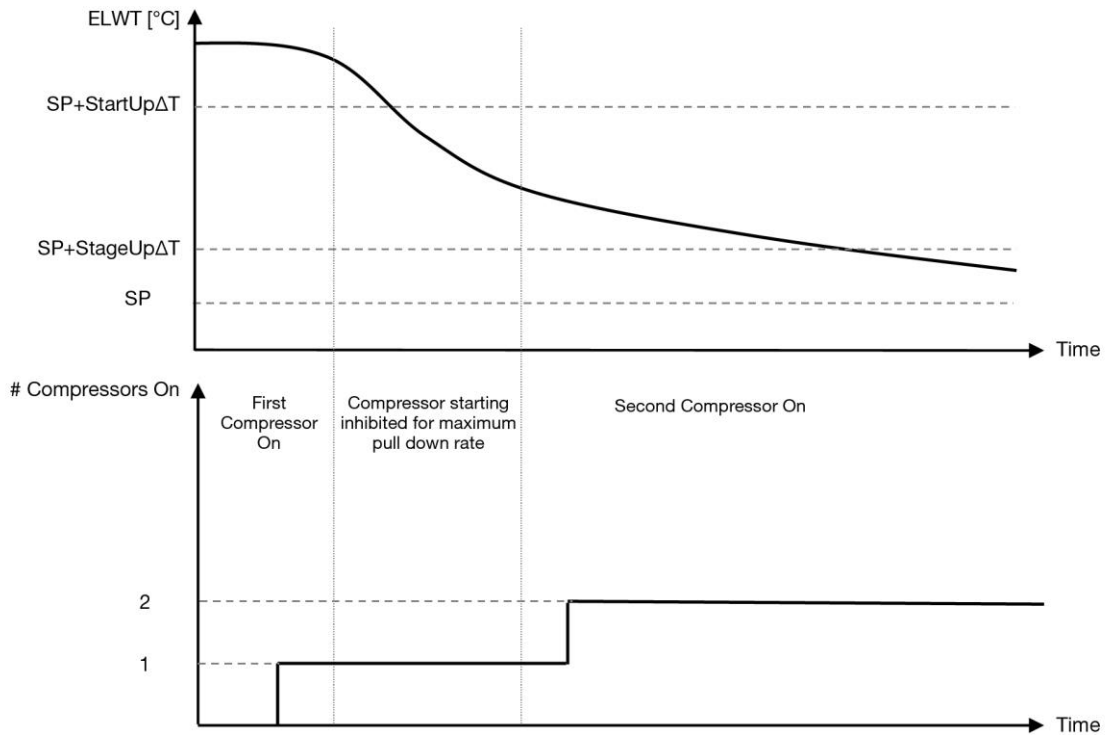

Graph 1 – Compressors start-up sequence - Cool mode

Thermostatic control settings are accessible from menu [9]:

Menu	Parameter	Range	Description	R/W	Psw
09	00 (Start Up DT)	0-5	Delta temperature respect the active setpoint to start the unit (startup of first compressor)	W	1
	01 (Shut Down DT)	0-MIN (5, 60.5-LwtSp)	Delta temperature respect the active setpoint to stop the unit (shutdown of latest compressor)	W	1
	02 (Stage Up DT)	0-5	Delta temperature respect the active setpoint to start second compressor	W	1
	03 (Stage Down DT)	0-MIN (5, 60-LwtSp)	Delta temperature respect the active setpoint second compressor	W	1
	04 (Stage Up Delay)	1÷60 [min]	Minimum time between the compressor startup	W	1
	05 (Stage Down Delay)	0÷30 [min]	Minimum time between the compressor shutdown	W	1
	06 (Evaporator Freeze)	if Unit mode = 0 or 2 +2 ÷ 6 [°C]	Defines the minimum water temperature before the unit alarm for evaporator freezing in triggered	W	2
	07 (Low Pressure Unload)	if Unit mode = 0 or 2 600÷800 [kPa]	Minimum pressure before compressor starts unload action in order to increase evaporating pressure	W	2

The path in the Web HMI interface is "Main Menu → View/Set Unit → Thermostatic Control".

3.11. External Alarm

The External Alarm is a digital contact that can be used to communicate to the UC an abnormal condition, coming from an external device connected to the unit. This contact is located in the customer terminal box and depending on the configuration can causes a simple event in the alarm log or also the unit stop. The alarm logic associated to the contact is the following:

Contact state	Alarm State	Note
Opened	Alarm	The alarm is generated if the contact remains opened for at least 5 seconds
Closed	No Alarm	The alarm is reset just the contact is closed

The configuration is performed from Page [15] as shown below:

Menu	Parameter	Range	Description
15	05 (Ext Alarm)	0 = No	External Alarm disabled
		1 = Event	Event configuration generates an alarm in the controller but takes the unit running
		2 = Rapid Stop	Rapid Stop configuration generates an alarm in the controller and performs a rapid stop of the unit
		3 = Pumpdown	Pumpdown configuration generates an alarm in the controller and performs a pumpdown procedure to stop the unit

The web HMI path for the External Alarm configuration is: **Commissioning → Configuration → Options**

3.12. Unit Capacity

Information about the unit's current and individual circuit capacities can be accessed from menu Page [3].

Menu	Parameter	Range	Description	R/W
03	00 (Circuit 1 Capacity)	0-100%	Circuit 1 capacity in percentage	R
	01 (Circuit 1 Fan Stage)	0..2	Number of Circuit 1 fans running	R
	02 (Circuit 1 Fan Speed)	0-100%	Fan Speed of Circuit 1 in percentage	R
	03 (Circuit 2 Capacity)	0-100%	Circuit 2 capacity in percentage	R
	04 (Circuit 2 Fan Stage)	0..2	Number of Circuit 2 fans running	R

	05 (Circuit 2 Fan Speed)	0-100%	Fan Speed of Circuit 2 in percentage	R
	06 (Total Unit Current)	A	Sum of absorbed currents by the unit	R

In the HMI Web Interface, some of these information are available in the paths:

- Main Menu → View/Set Circuit → Circuit 1 (or Circuit 2) → Data
- Main Menu → View/Set Circuit → Circuit 1 (or Circuit 2) → Fans
- Main Menu → View/Set Circuit → Circuit 1 (or Circuit 2) → Compressors

3.13. Power Conservation

In this chapters will be explained the functions used to reduce the unit power consumption:

1. Demand Limit
2. Current Limit
3. Setpoint Reset

3.13.1. Demand Limit

The “Demand limit” function allows the unit to be limited to a specified maximum load. Capacity limit level is regulated using an external 0-10 V signal with a linear relationship shown in the picture below. A signal of 0 V indicates the maximum capacity available whereas a signal of 10 V indicates the minimum capacity available.

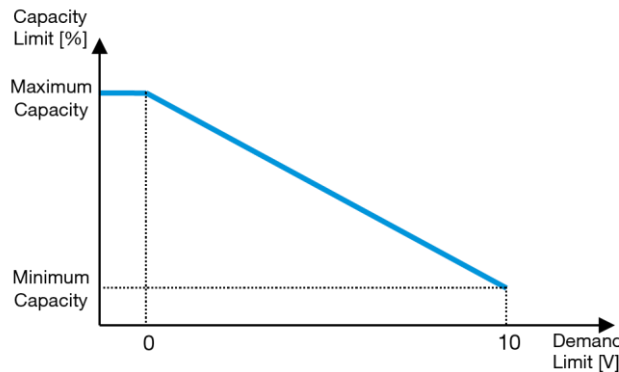

Graph 2 – Demand Limit[V] vs Capacity Limit [%]

It is worth pointing out that it is not possible to shut down the unit using the demand limit function, but only to unload it to its minimum capacity.

The option can be activated through the HMI Unit Interface in the menu [18] Power Conservation, parameter 00:

Menu	Parameter	Range	Description	R/W
18	00 (Demand Limit Enable)	0-1 (Off-On)	Off = Demand Limit Disabled On = Demand Limit Enabled	W
	01 (Current Lim Sp)	0-200A	The maximum current limit that the unit can reach.	W

In order to enable this option in the HMI Web Interface, go to “Main Menu → Commission Unit → Configuration → options” and set the Demand Limit parameter to Yes.

All info about this function are reported in the “Main Menu → View/Set Unit → Power Conservation → Demand Limit” page in the HMI Web Interface.

3.13.2. Current Limit

Current limit function allows to control unit power consumption taking current drawn below a specific limit. In order to activate the function Current Limit, the user can set a Current Limit Setpoint lower than the Default value, defined through the HMI or BAS communication.

The current limit uses a deadband centered around the actual limit value, such that unit capacity increase is not allowed when current is within this deadband. If unit current is above the deadband, capacity is decreased until it is back within the deadband. The current limit deadband is 5% of the current limit.

The Current Limit setpoint is accessible through the HMI, in the menu [18] Power Conservation, parameter 01 (refer to previous paragraph).

All info about this function are reported in the “Main Menu → View/Set Unit → Power Conservation → Current Limit” page in the HMI Web Interface.

3.13.3. Setpoint Reset

The “Setpoint Reset” function can override the chiller water temperature active setpoint when certain circumstances occur. The aim of this function is to reduce the unit energy consumption whilst maintaining the same comfort level. To this purpose, three different control strategies are available:

- Setpoint Reset by Outside Air Temperature (OAT)
- Setpoint Reset by an external signal (0-10V)
- Setpoint Reset by Evaporator ΔT (EWT)

In order to set the desired setpoint reset strategy, go to the parameter group number [20] “Setpoint Reset”, according to the following table:

Menu	Parameter	Range	Description	R/W
20	00 (Reset Type)	0-3	0 = No	W
			1 = 0-10V	
			2 = DT	
			3 = OAT	

The path in the HMI Web interface to set the desired strategy is “Main Menu → Commission Unit → Configuration → Options” and modify the **Setpoint Reset** parameter.

Parameter	Range	Description
LWT Reset	No	Setpoint reset not enabled
	0-10V	Setpoint reset enabled by an external signal between 0 and 10V
	DT	Setpoint reset enabled by Evaporator Water Temperature
	OAT	Setpoint reset enabled by Outside Air Temperature

Each strategy needs to be configured (although a default configuration is available) and its parameters can be set navigating to “Main Menu → View/Set Unit → Power Conservation → Setpoint Reset” in the HMI Web interface.



Note that the parameters corresponding to a specific strategy will be available only once the Setpoint Reset has been set to a specific value and the UC has been restarted.

3.13.3.1. Setpoint Reset by OAT

When the **OAT** is selected as **Setpoint Reset** option, the LWT active setpoint (AS) is calculated applying a correction to the basic setpoint that depends on the ambient temperature (OAT) and on the current Unit Mode (Heating mode or Cooling mode). Several parameters can be configured, and they are accessible from the **Setpoint Reset** menu, go to the parameter group number [20] “Setpoint Reset”, according to the following table:

Menu	Parameter	Range	Description	R/W
20	01 (Max Reset)	0..10 [°C]	Max Reset setpoint. It represents the maximum temperature variation that the selection of the Setpoint Reset logic can cause on the LWT.	W
	03 (Max Reset Cooling)	10..30 [°C]	Max Reset possible for the ELWT Setpoint in Cooling Mode.	W
	04 (Start Reset Cooling)	10..30 [°C]	It represents the “threshold temperature” of the OAT to activate the LWT setpoint reset, in cooling mode, i.e. the LWT setpoint is overwritten only if the OAT reaches/overpasses the SRCooling.	W
	05 (Max Reset Heating)	-10..10 [°C]	Max Reset possible for the ELWT Setpoint in Heating Mode.	W
	06 (Start Reset Heating)	-10..10 [°C]	It represents the “threshold temperature” of the OAT to activate the LWT setpoint reset, in Heating mode, i.e. the LWT setpoint is overwritten only if the OAT reaches/overpasses the SRHeating.	W

Provided the unit is set in Cooling mode (Heating mode), the more the ambient temperature drops below (goes beyond) the SROAT, the more the LWT active setpoint (AS) is increased(decreased), until the OAT reaches the Max Reset (MR)

limit. When the OAT overpasses the MROAT, the active setpoint does not increase(decrease) anymore, and it remains stable to its maximum(minimum) value, i.e. $AS = LWT + MR(-MR)$.

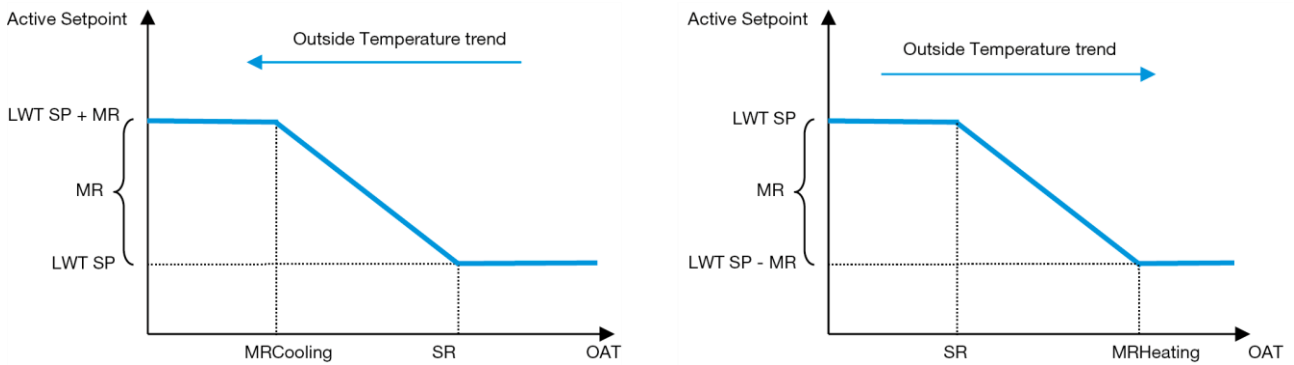

Graph 3 – Outside Ambient Temperature vs Active Setpoint - Cooling mode(left)/ Heating mode(right)

3.13.3.2. Setpoint Reset by 0-10V signal

When the **0-10V** is selected as **Setpoint Reset** option, the LWT active setpoint (AS) is calculated applying a correction based on an external 0-10V signal: 0 V corresponds to 0°C correction, i.e. $AS = LWT$ setpoint, whereas 10 V corresponds to a correction of the Max Reset (MR) quantity, i.e. $AS = LWT$ setpoint + MR(-MR) as shown in the following picture:

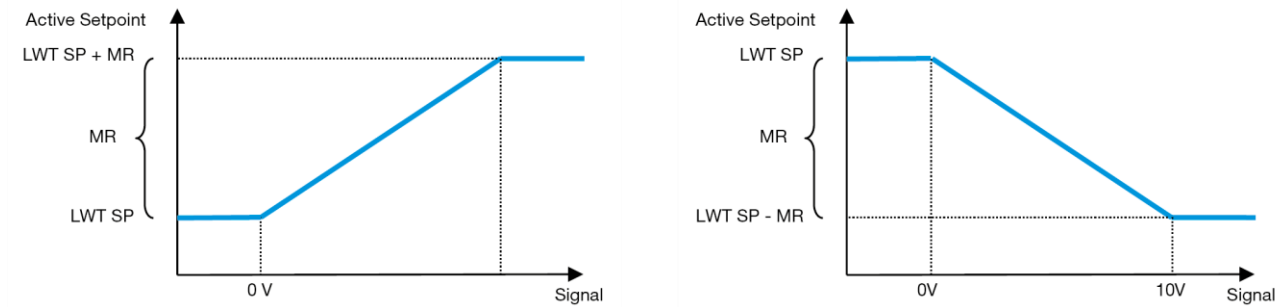

Graph 4 – External signal 0-10V vs Active Setpoint - Cooling mode(left)/ Heating mode(right)

Several parameters can be configured, and they are accessible from the **Setpoint Reset** menu, go to the parameter group number [16] "Setpoint Reset", according to the following table:

Menu	Parameter	Range	Description	R/W
20	01 (Max Reset)	0..10 [°C]	Max Reset setpoint. It represents the maximum temperature variation that the selection of the Setpoint Reset logic can cause on the LWT.	W

3.13.3.3. Setpoint Reset by DT

When the **DT** is selected as **Setpoint Reset** option, the LWT active setpoint (AS) is calculated applying a correction based on the temperature difference ΔT between the leaving water temperature (LWT) and the evaporator entering(returning) water temperature (EWT). When the $|\Delta T|$ becomes smaller than the Start Reset ΔT setpoint (SR ΔT), the LWT active setpoint is proportionally increased (if Cooling mode set) or decreased (if Heating mode is set) of a maximum value equal to the Max Reset (MR) parameter.

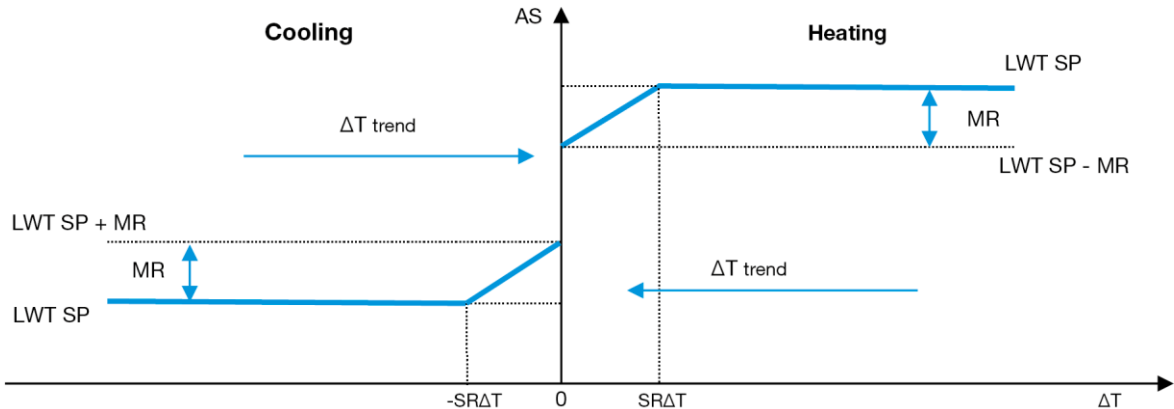

Graph 5 – Evap ΔT vs Active Setpoint - Cooling mode(left)/ Heating mode(right)

Several parameters can be configured, and they are accessible from the **Setpoint Reset** menu, as shown below:

Menu	Parameter	Range	Description	R/W
20	01 (Max Reset)	0..10 [°C]	Max Reset setpoint. It represents the maximum temperature variation that the selection of the Setpoint Reset logic can cause on the LWT.	W
	02 (Start Reset DT)	0..10 [°C]	It represents the “threshold temperature” of the DT to activate the LWT setpoint reset, i.e. the LWT setpoint is overwritten only if the DT reaches/overpasses the SR ΔT .	W

3.14. Controller IP Setup

The Controller IP Setup can be accessed from menu [13] where is possible to choose between the static or dynamic IP and manually set IP and network Mask.

Menu	Parameter	Sub-Parameter	Description	R/W
13	00 (DHCP)	N/A	Off = DHCP Off The DHCP option is disabled.	W
			On = DHCP On The DHCP option is enabled.	
	01 (IP)	N/A	“xxx.xxx.xxx.xxx” Represent the current IP address of Indoor Unit. Once entered [13.01] parameter, the HMI will automatically switch between all four IP-Address fields.	R
	02 (Mask)	N/A	“xxx.xxx.xxx.xxx” Represent the current Subnet Mask address. Once entered [13.02] parameter, the HMI will automatically switch between all four Mask fields.	R
	03 (Manual IP)	00 IP#1	Defines the first field of IP-Address	W
		01 IP#2	Defines the second field of IP-Address	W
		02 IP#3	Defines the third field of IP-Address	W
		03 IP#4	Defines the fourth field of IP-Address	W
	04 (Manual Mask)	00 Msk#1	Defines the first field of Mask	W
		01 Msk#2	Defines the second field of Mask	W
02 Msk#3		Defines the third field of Mask	W	
03 Msk#4		Defines the fourth field of Mask	W	
05 (Outdoor IP)	N/A	“xxx.xxx.xxx.xxx” Represent the current IP address of Outdoor Unit. Once entered [13.05] parameter, the HMI will automatically switch between all four IP-Address fields.	R	

In order to modify the POL468.85/MCQ IP Network configuration, do the following operations:

- access the **Settings** menu
- set the DHCP option to Off
- modify the IP, Mask, Gateway, PrimDNS and ScndDNS addresses, if needed, taking care of the current network settings
- set **Apply Changes** parameter to **Yes** to save the configuration and restart the POL468.85/MCQ controller.

The default internet configuration is:

Parameter	Default Value
IP	192.168.1.42
Mask	255.255.255.0
Gateway	192.168.1.1
PrimDNS	0.0.0.0
ScndDNS	0.0.0.0

Note that if the DHCP is set to On and the POL468.85/MCQ internet configurations shows the following parameter values then an internet connection problem has occurred (probably due to a physical problem, like the Ethernet cable breaking).

Parameter	Value
IP	169.254.252.246
Mask	255.255.0.0
Gateway	0.0.0.0
PrimDNS	0.0.0.0
ScndDNS	0.0.0.0

3.15. Daikin On Site

Daikin on site connection can be enabled and monitored through menu [12]:

Menu	Parameter	Range	Description	R/W	Psw
12	00 (Enable)	Off = Connection Off	DoS connection is disabled	W	1
		On = Connection On	DoS connection is enabled		
	01 (State)	0-6 = Not connected 7 = Connected	DoS actual connection state	R	1

In order to use the DoS utility, the customer has to communicate the **Serial Number** to Daikin company and subscribe to the DoS service. Then, from this page, it is possible to:

- Start/Stop the DoS connectivity
- Check the connection status to DoS service
- Enable/Disable the remote update option

In the unlikely event of UC replacement, the DoS connectivity can be switched from the old PLC to the new one just communicating the current **Activation Key** to Daikin company.

The Daikin on Site (DoS) page can be accessed navigating through the HMI Web Interface, with path "**Main Menu** → **View/Set Unit** → **Daikin On Site**".

3.16. Date/Time

The unit controller can take stored the actual date and time, that are used for Scheduler, and can be modified going in [10] and [11] menu:

Menu	Parameter	Range	Description	R/W
10	00 (Day)	0...7	Defines actual day stored in UC	W
	01 (Month)	0...12	Defines actual month stored in UC	W
	02 (Year)	0..9999	Defines actual year stored in UC	W
11	00 (Hour)	0...24	Defines actual hour stored in UC	W
	01 (Minute)	0...60	Defines actual minute stored in UC	W

The Date/Time information can be found at path "Main Menu → View/Set Unit → Date/Time".



Remember to check periodically the controller battery in order to maintain updated date and time even when there is no electrical power. Refer to controller maintenance section.

3.17. Master/Slave

Master/Slave protocol integration requires the selection of the address for each unit that we want to control. In each system we can have only one master and a maximum of three slaves and it's necessary to indicate the correct number of slaves. "SCM Address" and "SCM Number of Units" can be selected through the parameters [15.04] and [15.07].

Notice that SCM is not compatible with Pump Control Mode VPF and DT.

Menu	Parameter	Description	R/W
15 (Customer Configuration)	04 (Address)	0 = Standalone 1 = Master 2 = Slave1 3 = Slave2 4 = Slave3	W
	07 (Number of Units)	0 = 2 Units 1 = 3 Units 2 = 4 Units	W

Address and Number of Units can be also set in the Web HMI path "Main Menu → Commission Unit → Configuration → Options".

Master Slave parameter can be set in Page [16] and are available only in Master Unit:

Menu	Parameter	Range	R/W	Psw
[16] Master/Slave (Available only for Master Unit)	[16.00] Start Up Limit	0-5	W	1
	[16.01] Shut Dn Limit	0-5	W	1
	[16.02] Stage Up Time	0-20 min	W	1
	[16.03] Stage Dn Time	0-20 min	W	1
	[16.04] Threshold	30-100	W	1
	[16.05] PrioSlave#1	1-4	W	1
	[16.06] PrioSlave#2	1-4	W	1
	[16.07] PrioSlave#3	1-4	W	1
	[16.08] MasterPriority	1-4	W	1
	[16.09] Master Enable	Off-On	W	1
	[16.10] Standby Chiller	None/Auto/Master/Slave1/Slave2/Slave3	W	1
	[16.11] Cycling Type	Run Hours/Sequence	W	1
	[16.12] Interval Time	1-365	W	1
	[16.13] Switch Time	1-24	W	1
	[16.14] Temp Compensation	Off-On	W	1
	[16.15] Tmp Cmp Time	0-600 minutes	W	1
	[16.16] M/S Alarm Code	0..511	R	1
	[16.17] M/S UnitStates	0000..3333	R	1
[16.18] Switch Set	Off-On	W	1	

The path in the Web HMI interface for Master/Slave configuration is "Main Menu → Commission Unit → Configuration → Master/Slave".

Please refer to specific documentation for more information about of this topic.

3.18. Unit Boost

The unit boost is the possibility to increase the maximum compressor frequency to obtain higher capacity. A unit with boost enabled is called MAX VERSION; in this type of unit the UC automatically changes the operating range of compressor depending on the unit size.

Unit boost mode can be selected through the parameter [15.00].

Page	Parameter	Range	Description	R/W	Psw
[15] Customer Configuration	00 (Unit Boost)	0-1 (Off-On)	Off = Unit Not Boosted On = Unit Boosted	W	1

The path in the Web HMI interface for Unit Boost is **"Main Menu → Commission Unit → Options → Unit Boost"**.

3.19. Fan Boost

Fans maximum speed is typically fixed at its nominal value. When the Fan Boost is enabled, the maximum speed of all fans is increased. The ways fan boost can interact with modulation range of fans are:

- Fan Boost – Fixed
The upper limit of fans' modulation range is increased independently by the operating condition of the unit. This fan boost mode is available for both chiller and heat pump mode.
- Fan Boost – Automatic
The fans' maximum speed is increased only in certain condition in order to reduce the condensing pressure in critical operating conditions. This is the reason why the automatic mode of fan boost option is available only in chiller mode.

Fan boost mode can be selected through the parameter [15.01].

Page	Parameter	Range	Description	R/W	Psw
[15] Customer Configuration	01 (Fan Boost)	0-2	0 = Fan Not Boosted 1 = Fan Boosted - Fixed 2 = Fan Boosted - Automatic mode	W	1

The path in the Web HMI interface for Fan Boost is **"Main Menu → Commission Unit → Options → Fan Boost"**.

3.20. Costant Heating Capacity

This function has the purpose of keeping the heat capacity supplied by the machine unchanged as the ambient temperature decreases. This objective is achieved by increasing the maximum speed of the compressor, automatically managed by the UC according to the ambient temperature, which guarantees an instantaneous increase in thermal capacity.

The Costant Heating function can be activated through the parameter [15.06] of HMI.

Page	Parameter	Range	Description	R/W	Psw
[15] Customer Configuration	06 (Costant Heating)	0-1 (Off-On)	Off = Constant Heating Capacity disabled On = Constant Heating Capacity enabled	W	1

The path in the Web HMI interface for Costant Heating Capacity function is **"Main Menu → Commission Unit → Options → Costant Heating"**.

3.21. Domestic Hot Water

This function can be used to alternate normal unit operation with generation of domestic hot water. During "DHW" operation the unit is stopped, the water circuit is deviated by a 3VW and unit started on again to heat up a tank, containing the domestic hot water, until a the setpoint temperature is reached. At this point unit is switched back to normal operation.

This function expects a proper plant configuration and units' settings for both single-unit and multi-unit cases, please refer to specific documentation.

"Domestic hot water" function can be enabled by the register [15.09].

Page	Parameter	Range	Description	R/W	Psw
[15] Customer Configuration	09 (DHW Enable)	0-1 (Off-On)	Off = DHW Disabled On = DHW Enabled	W	1

Notice that DHW is not compatible with Pump Control Mode VPF, DT.

DHW Enable can be also set in the Web HMI path **"Main Menu → Commission Unit → Configuration → Options"**.

Domestic Hot Water parameters can be configured in Page [19]:

Menu	Parameter	Range	R/W	Psw
[19] DHW	[19.00] Setpoint	0...Max Heating Sp	W	1
	[19.01] Start Db	0..10 °C	W	1
	[19.02] Delay	0..600min	W	1
	[19.03] Temperature	°C	R	1
	[19.04] 3wv State	-	R	1
	[19.05] DHW Alarm Code	0..3	R	1
	[19.06] 3wv Type	0..1	W	1
	[19.07] 3wv Switch Time	0..900sec	W	1
	[19.08] Max Time	0..1440min	W	1
	[19.09] Standby Mode	0..1	W	1
	[19.10] Remote En	0..2	W	1
[19.11] Dhw Units States	0000..4444	R	1	

The path in the Web HMI interface for Domestic Hot Water configuration is "Main Menu → Commission Unit → Configuration → DHW Settings".

3.22. Customer Unit Configuration

Except for factory configurations, the client can custom the unit depending on his needs and options acquired. The allowed modifications regard Unit Boost, Fan Boost, HMI Type, Pump Ctrl Type, SCM Address, External Alarm, Costant Heating Capacity, SCM Number OF Units, Fan Silent Speed, Domestic Hot Water.

All these customer configurations for the unit can be set in page [15].

Page	Parameter	Range	Description	R/W	Psw
[15] Customer Configuration	00 (Unit Boost)	0-1 (Off-On)	Off = Unit Not Boosted On = Unit Boosted	W	1
	01 (Fan Boost)	0-2	0 = Fan Not Boosted 1 = Fan Boosted - Fixed 2 = Fan Boosted - Automatic mode	W	1
	02 (Not Used)	-	-	-	-
	03 (Pump Ctrl Type)	0-3	0 = On-Off Mode 1 = Fixed Speed 2 = VPF 3 = DeltaT Mode	W	1
	04 (SCM Address)	0-4	0 = Standalone 1 = Master 2 = Slave1 3 = Slave2 4 = Slave3	W	1
	05 (External Alarm)	0-3	0 = No 1 = Event 2 = Rapid Stop 3 = Pumpdown	W	1
	06 (Constant Heating)	0-1 (Off-On)	Off = Constant Heating Capacity disabled 1 = Constant Heating Capacity enabled	W	1
	07 (SCM Number of Units)	0-2	0 = 2 Units 1 = 3 Units 2 = 4 Units	W	1
	08 (Fan Silent Spd)	500-900	Defines fan maximum speed during Silent Mode	W	1
	09 (DHW Enable)	0-1 (Off-On)	Off = DHW Disabled On = DHW Enabled	W	1
	10 (SG Enable)	0-1 (Off-On)	Off = SG Disabled On = SG Enabled	W	1
11 (SwOptLite bit_0_3)	0000-1111	Bit0 = EKDAGBL Enabled Bit1 = Not Used Bit2 = Not Used Bit3 = Not Used	R	1	

The path in the Web HMI interface for Customer Configuration settings is "Main Menu → Commission Unit → Options".

3.23. Connectivity Kit & BMS Connection

The UC has two access ports for communications via Modbus RTU / BACnet MSTP or Modbus / BACnet TCP-IP protocol: RS485 port and Ethernet port. While the RS485 port is exclusive, on TCP-IP port it's possible to communicate simultaneously in both Modbus and BACnet.

The Modbus protocol is set as default on the RS485 port while access to all the other functions of BACnet MSTP/TCP-IP and Modbus TCP-IP are unlocked through *EKRSCBMS* activation.

Please refer to the Databook for protocols incompatibility with other unit functionality.

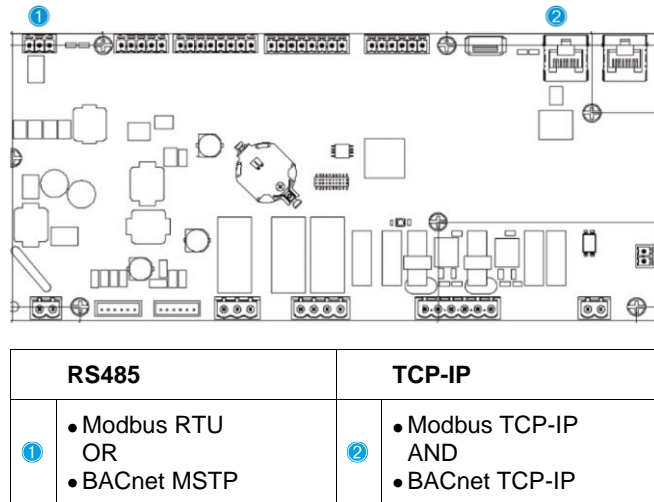

You can choose which protocol to use and set the communication parameters for both ports in Page [22].

Page	Parameter	Range	Description	R/W	Psw
22 (Protocol Communication)	00 (Mb Address)	1-255	Defines UC address in Modbus network.	W	1
	01 (Mb BAUD)	0-1000	Defines Modbus communication rate in Bps/100 and must be identical for all nodes of the bus.	W	1
	02 (Mb Parity)	0 = Even 1 = Odd 2 = None	Defines the parity used in Modbus communication and must be identical for all nodes of the bus.	W	1
	03 (Mb 2StopBit)	Off = 1 Stop-Bit On = 2 Stop Bits	Defines whether 2 stop bits should be used.	W	1
	04 (Mb Timeout)	0-10	Defines the timeout in second for the response of the slave before a communication error is reported.	W	1
	05 (BN Address)	1-255	Defines UC address in BacNET network.	W	1
	06 (BN BAUD)	0-1000 Bps/100	Defines BacNET communication rate in Bps/100 and must be identical for all nodes of the bus.	W	1
	07 BN (Device ID)	0-4.194.302 0-(X.XXX.---)	Defines the four most significant digits of Device ID, used in a BACnet network as the unique identifier of a specific device. The Device ID for each device must be unique on the entire BACnet network.	W	1
	08 BN (Device ID)	0-4.194.302 0-(---.XXX)	Defines the three less significant digits of Device ID, used in a BACnet network as the unique identifier of a specific device. The Device ID for each device must be unique on the entire BACnet network.	W	1
09 (BN Port)	0-65535 0-(X-.-)	Defines the most significant digit of BacNET UDP Port.	W	1	

	10 (BN Port)	0-65535 0-(-X.XXX)	Defines four less significant digits of BacNET UDP Port.	W	1
	11 (BN Timeout)	0-10	Defines the timeout in second for the response before a communication error is reported.	W	1
	12 (License Manager)	Off = Passive On = Active	Represent the actual state of <i>EKRSCBMS</i> .	R	1
	13 (BacNETOverRS)	Off = Passive On = Active	Defines whether to use the bacnet protocol instead of modbus on the RS485 port.	W	1
	14 (BacNET-IP)	Off = Passive On = Active	Defines the activation of BacNET TCP-IP protocol once <i>EKRSCBMS</i> is unlocked.	W	1
	15 (BasProtocol)	0 = None 1 = Modbus 2 = Bacnet	Defines which protocol's data the UC considers in its logic.	W	1
	16 (BusPolarization)	Off = Passive On = Active	Define the activation of internal polarization resistor of UC. It has to be set "Active" only on first unit of the network.	W	1

The path in the HMI Web interface to access this information is:

- Main Menu → view/Set Unit → Protocols

3.24. About Chiller

The application version and the BSP version represent the core of software installed on the controller. The [22] is only read page contains this information.

Page	Parameter	R/W	Psw
24 (About)	00 (App Vers)	R	0
	01 (BSP)	R	0

The path in the HMI Web interface to access this information is:

- Main Menu → About Chiller

3.25. HMI Screen Saver

After 5 minutes of waiting the interface is automatically addressed to the Screen Saver menu. This is an only read menu composed of 2 pages switched each other every 5 seconds.

During this phase the following parameters are displayed:

Parameter	Description
Page 1	String Up = Leaving Water Temperature String Dn = Actual Water Setpoint
Page 2	String Up = Unit Capacity String Dn = Unit Mode

To exit the Screen Saver menu, it's necessary to press any of four HMI button. The interface will come back to Page [0].

3.26. Generic Controller Operation

The main controller operations available are "Application Save" and "Apply Changes". The first one is used to save the current configuration of parameters in the UC in order to avoid the possibility to lose it if a power fail happens while the second one is used for some parameters which require an UC reboot in order to become effective.

These commands can be accessed from menu [24]:

Page	Parameter	Range	Description	R/W	Psw
23 (UC)	00 (AppSave)	Off = Passive On = Active	PLC executes an Application Save command	W	1
	01 (Apply Changes)	Off = Passive On = Active	PLC executes an Apply Changes command	W	1

In the HMI Web Interface, Application Save is available at the paths:

- Main Menu → Application Save

While the Apply Changes setpoint can be set at the path:

- Main Menu → View/Set Unit → Controller IP Setup → Settings

3.27. BEG – SG Ready & Energy Monitoring

At page [28], as described above, it's possible to navigate and reset the internal database storing monitored energies of last 24 month.

In case of Smart Grid operations (SG Box connected and smart grid functionalities enabled) the actual state read by the gateway is available too, otherwise [28.03] value is fixed at zero.

Page	Parameter	Range	Description	R/W	Ps w
[28] (BEG)	00 (EM Index)	0..72	The index selected defines the actual value displayed I “[28.01] (EM Value)” parameter. Cool Energy, Heat Energy and Power Input values are continuously added to actual month value. Last 24 energies value are available. In particular: 1-8 = CoolEnergy [month 1-8] 9-16 = ElectEnergy [month 1-8] 17-24 = CoolEnergy [month 9-16] 25-32 = ElectEnergy [month 9-16] 33-40 = CoolEnergy [month 17-24] 41-48 = ElectEnergy [month 17-24] 49-64 = HeatEnergy [month 1-16] 65-72 = HeatEnergy [month 17-24]	W	1
	01 (EM Value)	0.0...9999 (MWh)	The value displayed matches with the description of value associated to parameter “[28.00] (EM Index)”.	R	1
	02 (EM Reset)	Off = Passive On = Active	Command reset for energy monitoring database. It resets all stored values to zero and sets actual date as reference for “month 1” values. After a reset month 1's CoolEnergy, HeatEnergy and ElectEnergy will start to be updated depending on actual unite operations.	W	1
	03 (SG State)	0...4	The value represents the actual state sent by SG Gateway: 0 = SG Disabled/SG Box Communication Error 1 = (Bypass scheduler to force off) 2 = (Normal Operation) 3 = (Force Setpoint2) 4 = (Bypass scheduler to enable) & (Force setpoint2)	R	1

In the HMI Web Interface, all these parameters can be set at the following path:

- “Main → Commission Unit → Configuration → BEG Settings”



First start

For correct initialization of the Energy Monitoring function, a Reset command shall be done immediately before the first start-up of the unit; otherwise, database will be populated with values that do not respect the expected order.

**Date reference**

A reset command set the reference date for database. Changing data backward will cause and invalid state and database won't be updated until reference date it reached again. Changing data forward will cause a non-reversible shift of reference date and every database's cell from old reference date to actual one will be filled with a 0-value.



For M/S Multi-Units case configuration notes can be found in Smart Grid Ready Box Installation & Operating Manual D-EIOCP00301-23.

3.28. EKDAGBL - Restricted Application Definer

By activating EKDAGBL software option, the unit envelope keeps following compliancy to Eco-design regulation No. 813/2013 and the standard EN14825:2018, accordingly the unit falls within the definition of Low Temperature Heat Pump. Please refer to the dedicated Envelope.

3.29. HMI Parameters Navigation Table

In this table is reported the whole interface structure from main menu to any single parameter including the screen saver pages. Typically, the HMI is composed by pages, containing the parameters, accessible from Main menu. In few cases there is a two-level structure where a page contains other pages instead of parameters; a clear example is the page [17] dedicated to Scheduler management.

Menu	Parameter	Sub-Parameter	R/W	PSW
[0] Password	[00.00] Enter PSW	N/A	W	0
[1] Unit	[01.00] UEN	N/A	W	1
	[01.01] C1EN	N/A	W	1
	[01.02] C2EN	N/A	W	1
[2] Mode	[02.00] Available Modes	N/A	W	2
	[2.01] Mode Source	N/A	W	0
	[2.02] UnitCoolHeatsw	N/A	W	0
[3] Capacity	[03.00] C1_Cap	N/A	R	0
	[03.01] C1_FanStg	N/A	R	0
	[03.02] C1_FanCap	N/A	R	0
	[03.03] C2_Cap	N/A	R	0
	[03.04] C2_FanStg	N/A	R	0
	[03.05] C2_FanCap	N/A	R	0
	[03.06] SumCurrent	N/A	R	0
[4] Net	[04.00] Sour	N/A	W	1
	[04.01] En	N/A	R	0
	[04.02] C.SP	N/A	R	0
	[04.03] H.SP	N/A	R	0
	[04.04] Mode	N/A	R	0
	[04.05] Current Limit	N/A	R	0
	[04.06] Capacity Limit	N/A	R	0
[5] Setp	[05.00] C1	N/A	W	0
	[05.01] C2	N/A	W	0
	[05.02] H1	N/A	W	0
	[05.03] H2	N/A	W	0
[6] Tmps	[06.00] In	N/A	R	0
	[06.01] Out	N/A	R	0
	[06.02] OAT	N/A	R	0
	[06.03] DT	N/A	R	0
	[06.04] Syst	N/A	R	0
[7] Alms	[07.00] Alarm List	N/A	R	0
	[07.01] Alarm Clear	N/A	W	1
[8]	[08.00] Rect	N/A	W	1

Menu	Parameter	Sub-Parameter	R/W	PSW
Pump	[08.01] Standby Speed	N/A	W	1
	[08.02] Speed	N/A	R	1
	[08.03] Max Speed	N/A	W	1
	[08.04] Min Speed	N/A	W	1
	[08.05] Speed 1	N/A	W	1
	[08.06] Speed 2	N/A	W	1
	[08.07] LoadPressDropSp	N/A	W	1
	[08.08] EvapPressDropSp	N/A	W	1
	[08.09] BypassValve state	N/A	R	1
	[08.10] LoadPD	N/A	R	1
	[08.11] EvapPD	N/A	R	1
	[08.12] Parameter Ti	N/A	W	1
	[08.13] setpoint DT	N/A	W	1
	[08.14] Alarm Code	N/A	R	1
	[08.15] Sensor Scale	N/A	W	1
	[08.16] Pump On Limit	N/A	W	1
[9] Thermostatic control	[9.00] Startup	N/A	W	1
	[9.01] Shutdown	N/A	W	1
	[9.02] Stage up	N/A	W	1
	[9.03] Stage down	N/A	W	1
	[9.04] Stage up delay	N/A	W	1
	[9.05] Stage dn delay	N/A	W	1
	[9.06] Evap Freeze	N/A	W	2
	[9.07] Low Press Unld	N/A	W	2
[10] Date	[10.00] Day	N/A	W	0
	[10.01] Month	N/A	W	0
	[10.02] Year	N/A	W	0
[11] Time	[11.0] Hour	N/A	W	0
	[11.1] Minute	N/A	W	0
[12] DoS	[12.00] Enable	N/A	W	0
	[12.01] State	N/A	R	0
[13] IPst	[13.00] DHCP	N/A	W	0
	[13.01] Actual IP	N/A	R	0
	[13.02] Actual Mask	N/A	R	0
	[13.03] Manual IP		R	0
		[13.3.0] IP#1	W	0
		[13.3.1] IP#2	W	0
		[13.3.2] IP#3	W	0
		[13.3.3] IP#4	W	0
	[13.04] Manual Mask		W	0
		[13.4.0] Msk#1	W	0
		[13.4.1] Msk#2	W	0
		[13.4.2] Msk#3	W	0
	[13.4.3] Msk#4	W	0	
	[13.05] Outdoor IP	N/A	R	0
[15] Customer Configuration	[15.00] Unit Boost	N/A	W	1
	[15.01] Fan Boost	N/A	W	1
	[15.03] Pump Ctrl Type	N/A	W	1
	[15.04] Address	N/A	W	1
	[15.05] Ext Alm	N/A	W	1

Menu	Parameter	Sub-Parameter	R/W	PSW
	[15.06] Cost. Heating	N/A	W	1
	[15.07] SCM Number of Units	N/A	W	1
	[15.08] FansilentSpd	N/A	W	1
	[15.09] DHW Enable	N/A	W	1
	[15.10] SG Enable	N/A	W	1
	[15.11] swOptLite 0_3	N/A	R	1
[16] Master/Slave (Available only for Master Unit)	[16.00] Start Up Limit	N/A	W	1
	[16.01] Shut Dn Limit	N/A	W	1
	[16.02] Stage Up Time	N/A	W	1
	[16.03] Stage Dn Time	N/A	W	1
	[16.04] Threshold	N/A	W	1
	[16.05] PrioSlave#1	N/A	W	1
	[16.06] PrioSlave#2	N/A	W	1
	[16.07] PrioSlave#3	N/A	W	1
	[16.08] MasterPriority	N/A	W	1
	[16.09] Master Enable	N/A	W	1
	[16.10] Standby Chiller	N/A	W	1
	[16.11] Cycling Type	N/A	W	1
	[16.12] Interval Time	N/A	W	1
	[16.13] Switch Time	N/A	W	1
	[16.14] Temp Compensation	N/A	W	1
	[16.15] Tmp Cmp Time	N/A	W	1
	[16.16] M/S Alarm Code	N/A	R	1
	[16.17] M/S UnitStates	N/A	R	1
[16.18] switch Set	N/A	W	1	
[17] Scheduler	[17.00] Monday		W	1
		[17.0.0] Time 1	W	1
		[17.0.1] Value 1	W	1
		[17.0.2] Time 2	W	1
		[17.0.3] Value 2	W	1
		[17.0.4] Time 3	W	1
		[17.0.5] Value 3	W	1
		[17.0.6] Time 4	W	1
	[17.0.7] Value 4	W	1	
	[17.01] Tuesday		W	1
		[17.1.0] Time 1	W	1
		[17.1.1] Value 1	W	1
		[17.1.2] Time 2	W	1
		[17.1.3] Value 2	W	1
		[17.1.4] Time 3	W	1
		[17.1.5] Value 3	W	1
		[17.1.6] Time 4	W	1
	[17.1.7] Value 4	W	1	

	[17.06] Sunday		W	1
		[17.6.0] Time 1	W	1
[17.6.1] Value 1		W	1	
[17.6.2] Time 2		W	1	
[17.6.3] Value 2		W	1	
[17.6.4] Time 3		W	1	
[17.6.5] Value 3	W	1		

Menu	Parameter	Sub-Parameter	R/W	PSW
		[17.6.6] Time 4	W	1
		[17.6.7] Value 4	W	1
[18] Power Conservation	[18.00] Dem Lim EN	N/A	W	1
	[18.01] Current Lim Sp	N/A	W	1
[19] DHW	[19.00] Setpoint	N/A	W	1
	[19.01] Start Db	N/A	W	1
	[19.02] Delay	N/A	W	1
	[19.03] Temperature	N/A	R	1
	[19.04] 3wv State	N/A	R	1
	[19.05] DHW Alarm Code	N/A	R	1
	[19.06] 3wv Type	N/A	W	1
	[19.07] 3wv Switch Time	N/A	W	1
	[19.08] Max Time	N/A	W	1
	[19.09] Standby Mode	N/A	W	1
	[19.10] Remote En	N/A	W	1
	[19.11] DhW Units States	N/A	R	1
[20] Setpoint reset	[20.00] Reset Type	N/A	W	1
	[20.01] Max Reset DT	N/A	W	1
	[20.02] Start Reset DT	N/A	W	1
	[20.03] Max Reset CH	N/A	W	1
	[20.04] Start Reset CH	N/A	W	1
	[20.05] Max Reset HP	N/A	W	1
	[20.06] Start Reset HP	N/A	W	1
[22] Protocol Communication	[22.00] Mb Address	N/A	W	1
	[22.01] Mb BAUD	N/A	W	1
	[22.02] Mb Parity	N/A	W	1
	[22.03] Mb 2StopBit	N/A	W	1
	[22.04] Mb Timeout	N/A	W	1
	[22.05] BN Address	N/A	W	1
	[22.06] BN BAUD	N/A	W	1
	[22.07] BN Device ID (X.XXX.---	N/A	W	1
	[22.08] BN Device ID (-.---.XXX)	N/A	W	1
	[22.9] BN Port (X-.---	N/A	W	1
	[22.10] BN Port(-X.XXX)	N/A	W	1
	[22.11] BN Timeout	N/A	W	1
	[22.12] Licence Mngr	N/A	R	1
	[22.13] BacNETOverRS	N/A	W	1
	[22.14] BacNET-IP	N/A	W	1
	[22.15] BasProtocol	N/A	W	1
	[22.16] BusPolarization	N/A	W	1
[23] PLC	[23.0] AppSave	N/A	W	1
	[23.1] Apply Changes	N/A	W	1
[24] About	[24.00] App Vers	N/A	R	0
	[24.01] BSP	N/A	R	0
[25] Screen Saver	- LWT (String Up) - Setpoint Act (String Dn)	- Unit Cap (String Up) - Actual Mode (String Dn)	R	0
[28] BEG Settings	[28.00] EM Index	- N/A	W	1
	[28.01] EM Value	- N/A	R	1
	[28.02] EM Reset	- N/A	W	1
	[28.03] SG State	- N/A	R	1

4. ALARMS AND TROUBLE SHOOTING

The UC protects the unit and the components from damaging in abnormal conditions. Alarms can be divided in pump-down and rapid stop alarms. Pump-down alarms are activated when the system or sub-system can perform a normal shutdown in spite of the abnormal running conditions. Rapid stop alarms are activated when the abnormal running conditions require an immediate stop of the whole system or sub-system to prevent potential damages.

When an alarm occurs the proper alert icon will be turned on.

- In case of Master/Slave or VPF function enabled it's possible to have alert icon blinking with [07.00]'s value equal to zero. In these cases, unit is enabled to run because the alert icon refers to function errors, not unit ones, but registers [08.14] or [16.16] will report value greater than zero. Please refer to specific documentation for Master/Slave or VPF function troubleshooting.

In case of alarm occurrence, it's possible to try an "Alarm Clear" through the [7.01] parameter in order to allow the unit restart.

Please notice that:

- If alarm persist refer to table in chapter "Alarm List: Overview" for possible solutions.
- If alarm continue to occur after manual resets, contact your local dealer.

If an error code is displayed, be sure to remove the cause before restarting operation. Repeatedly resetting the error and restarting operation without removing the cause may result in a serious malfunction.

4.1. Alarms List: Overview

The HMI displays the active alarms in the dedicated page [7]. Once entered this page the number of actual active alarms is displayed. In this page will be possible to scroll the complete list of active alarms and apply the "Alarm Clear" too.

Page	Parameter	Description	R/W	Psw
[7]	00 (Alarm List)	Alarm Mapping HMI	R	0
	01 (Alarm Clear)	Off = Maintain alarms On = Execute alarms reset	W	1

The table of possible codes for parameter [7.00] is:

Alarm Type	HMI Code	Mapping Alarm	Cause	Solution
Unit	U001	UnitExternalEvent	External signal mapped as Event detected by UC	<ul style="list-style-type: none"> ▪ Check customer external signal source
	U002	UnitOff TimeNotValid	UC's date and time setting not properly configured	<ul style="list-style-type: none"> ▪ Check date and time configuration ▪ Contact your local dealer
	U003	UnitOff EvapwaterFlow	Water circuit malfunction	<ul style="list-style-type: none"> ▪ Check that water flow is possible (open all valves in the circuit) ▪ Check wiring connection ▪ Contact your local dealer
	U004	UnitOffEvapwaterTmpLo	Water temperature under minimum limit	<ul style="list-style-type: none"> ▪ Contact your local dealer
	U005	UnitOffExternalAlarm	External signal mapped as Alarm detected by UC	<ul style="list-style-type: none"> ▪ Check customer external signal source
	U006	UnitOffEvpLvgwTempSen	Temperature sensor not detected	<ul style="list-style-type: none"> ▪ Check sensor wiring connection ▪ Contact your local dealer
	U007	UnitOffEvpEntwTempSen	Temperature sensor not detected	<ul style="list-style-type: none"> ▪ Check sensor wiring connection ▪ Contact your local dealer
	U008	UnitOffAmbTempSen	Temperature sensor not detected	<ul style="list-style-type: none"> ▪ Check sensor wiring connection ▪ Contact your local dealer
	U009	BadDemandLimitInput	Signal detected out of range	<ul style="list-style-type: none"> ▪ Check signal applied to UC ▪ Check wiring connection ▪ Contact your local dealer
	U010	BadSetPtOverrideInput	Signal detected out of range	<ul style="list-style-type: none"> ▪ Check signal applied to UC ▪ Check wiring connection ▪ Contact your local dealer

	U011	UnitOffGasSensf	Gas leakage sensor not detected	<ul style="list-style-type: none"> ▪ Check sensor wiring connection ▪ Contact your local dealer
	U012	UnitOffACSCommFail	Bad ACS communication	<ul style="list-style-type: none"> ▪ Check deep switch on ACS module ▪ Check wiring connection ▪ Contact your local dealer
	U013	StartInhbtAmbTempLo	Ambient temperature detected under limit	<ul style="list-style-type: none"> ▪ Check Unit is working in allowed conditions
	U014	EvapPump1Fault	Pump Error	<ul style="list-style-type: none"> ▪ Check sensor pump connection ▪ Contact your local dealer
	U015	PumpInvMbCommFail	Bad Inverter pump communication	<ul style="list-style-type: none"> ▪ Check alarm/warning LEDs on inverter pump ▪ Check pump inverter wiring connection ▪ Contact your local dealer
	U016	UnitOffDHWAlarm	Domestic Hot Water Alarms	<ul style="list-style-type: none"> ▪ Check [19.05] DHW Alarm Code value ▪ Check Domestic Hot Water 3WV status ▪ Check 3WV wiring connection ▪ Contact your local dealer
	U017	UnitOffOutdoorCommErr	Bad outdoor unit communication	<ul style="list-style-type: none"> ▪ Check outdoor power supply ▪ Check communication wiring ▪ Contact your local dealer
	U018	UnitOffConfMismatchErr	Outdoor unit configuration error	<ul style="list-style-type: none"> ▪ Contact your local dealer
	U019	UnitOffSwMismatchAl	Different UC software installed on outdoor unit	<ul style="list-style-type: none"> ▪ Contact your local dealer
	U020	UnitOffGasLeakage	Gas leakage detected	<ul style="list-style-type: none"> ▪ Contact your local dealer
	U021	UnitOffGasSensOOR	Signal detected out of range	<ul style="list-style-type: none"> ▪ Check sensor wiring connection ▪ Contact your local dealer
Circuit 1	C101	C1Cmp1 OffPrRatioLo	Pressure ratio under minimum limit	<ul style="list-style-type: none"> ▪ Contact your local dealer
	C102	C1 OffNoPressChgStart	No pressure delta detected by UC	<ul style="list-style-type: none"> ▪ Contact your local dealer
	C103	C1Fan OffVfdCommFail	Bad fan inverter communication	<ul style="list-style-type: none"> ▪ Check fan inverter wiring connection ▪ Contact your local dealer
	C104	C1Cmp1 OffVfdCommFail	Bad compressor inverter communication	<ul style="list-style-type: none"> ▪ Check compressor inverter wiring connection ▪ Contact your local dealer
	C105	C1Cmp1 OffEvapPressLo	Evaporating pressure under minimum limit	<ul style="list-style-type: none"> ▪ Contact your local dealer
	C106	C1Cmp1 OffCndPressHi	Condensing pressure over maximum limit	<ul style="list-style-type: none"> ▪ Contact your local dealer
	C107	C1Cmp1 OffDischTmpHi	Discharge temperature over maximum limit	<ul style="list-style-type: none"> ▪ Contact your local dealer
	C108	C1Cmp1 OffMtrAmpsHi	Compressor current over maximum limit	<ul style="list-style-type: none"> ▪ Contact your local dealer
	C109	C1 OffStartFailEvapPrLo	No evaporating or condensing pressure detected at start	<ul style="list-style-type: none"> ▪ Check sensors wiring connection ▪ Contact your local dealer
	C110	C1Cmp1 EvapPressSen	Pressure sensor not detected	<ul style="list-style-type: none"> ▪ Check sensor wiring connection ▪ Contact your local dealer
	C111	C1Cmp1 CondPressSen	Pressure sensor not detected	<ul style="list-style-type: none"> ▪ Check sensor wiring connection ▪ Contact your local dealer
	C112	C1Cmp1 OffMotorTempHi	Motor temperature over maximum limit	<ul style="list-style-type: none"> ▪ Check wiring connection ▪ Contact your local dealer

	C113	C1Cmp1 offSuctTempSen	Temperature sensor not detected	<ul style="list-style-type: none"> ▪ Check sensor wiring connection ▪ Contact your local dealer
	C114	C1Cmp1 offDischTmpSen	Temperature sensor not detected	<ul style="list-style-type: none"> ▪ Check sensor wiring connection ▪ Contact your local dealer
	C115	C1 Failed Pumpdown	Pumpdown procedure exedes maximum time	<ul style="list-style-type: none"> ▪ Contact your local dealer
	C116	C1Cmp1 offVfdFault	Detected compressor inverter alarm	<ul style="list-style-type: none"> ▪ Contact your local dealer
	C117	C1 FanAlm	Detected fan inverter alarm	<ul style="list-style-type: none"> ▪ Contact your local dealer
	C118	-	-	-
	C119	C1Cmp1 offLowDiscSH	Discharge super heat under minimum limit	<ul style="list-style-type: none"> ▪ Contact your local dealer
	C120	C1Cmp1 offMechPressHi	Condensing pressur over mechanical pressure switch	<ul style="list-style-type: none"> ▪ Mechanical reset of switch ▪ Contact your local dealer
Circuit 2	C201	C2Cmp1 offPrRatioLo	Pressure ratio under minimum limit	<ul style="list-style-type: none"> ▪ Contact your local dealer
	C202	C2 offNoPressChgStart	No pressure delta detected by UC	<ul style="list-style-type: none"> ▪ Contact your local dealer
	C203	C2Fan offVfdCommFail	Bad fan inverter communication	<ul style="list-style-type: none"> ▪ Check fan inverter wiring connection ▪ Contact your local dealer
	C204	C2Cmp1 offVfdCommFail	Bad compressor inverter communication	<ul style="list-style-type: none"> ▪ Check compressor inverter wiring connection ▪ Contact your local dealer
	C205	C2Cmp1 offEvpPressLo	Evaporating pressure under minimum limit	<ul style="list-style-type: none"> ▪ Contact your local dealer
	C206	C2Cmp1 offCndPressHi	Condensing pressure over maximum limit	<ul style="list-style-type: none"> ▪ Contact your local dealer
	C207	C2Cmp1 offDischTmpHi	Discharge temperature over maximum limit	<ul style="list-style-type: none"> ▪ Contact your local dealer
	C208	C2Cmp1 offMtrAmpsHi	Compressor current over maximum limit	<ul style="list-style-type: none"> ▪ Contact your local dealer
	C209	C2 offStartFailEvpPrLo	No evaporating or condensing pressure detected at start	<ul style="list-style-type: none"> ▪ Check sensors wiring connection ▪ Contact your local dealer
	C210	C2Cmp1 EvapPressSen	Pressure sensor not detected	<ul style="list-style-type: none"> ▪ Check sensor wiring connection ▪ Contact your local dealer
	C211	C2Cmp1 CondPressSen	Pressure sensor not detected	<ul style="list-style-type: none"> ▪ Check sensor wiring connection ▪ Contact your local dealer
	C212	C2Cmp1 offMotorTempHi	Motor temperature over maximum limit	<ul style="list-style-type: none"> ▪ Check wiring connection ▪ Contact your local dealer
	C213	C2Cmp1 offSuctTempSen	Temperature sensor not detected	<ul style="list-style-type: none"> ▪ Check sensor wiring connection ▪ Contact your local dealer
	C214	C2Cmp1 offDischTmpSen	Temperature sensor not detected	<ul style="list-style-type: none"> ▪ Check sensor wiring connection ▪ Contact your local dealer
	C215	C2 Failed Pumpdown	Pumpdown procedure exedes maximum time	<ul style="list-style-type: none"> ▪ Contact your local dealer
	C216	C2Cmp1 offVfdFault	Detected compressor inverter alarm	<ul style="list-style-type: none"> ▪ Contact your local dealer
	C217	C2 FanAlm	Detected fan inverter alarm	<ul style="list-style-type: none"> ▪ Contact your local dealer
	C218	-	-	-
	C219	C2Cmp1 offLowDiscSH	Discharge super heat under minimum limit	<ul style="list-style-type: none"> ▪ Contact your local dealer
	C220	C2Cmp1 offMechPressHi	Condensing pressur over mechanical pressure switch limit	<ul style="list-style-type: none"> ▪ Mechanical reset of switch ▪ Contact your local dealer

In the HMI Web Interface, this information is available in the paths:

- **Main Menu → Alarms → Alarm List**

4.2. Troubleshooting

If one of the following malfunctions occur, take the measures shown below and contact your dealer.



Stop operation and shut off the power if anything unusual occurs (burning smells etc.).

Leaving the unit running under such circumstances may cause breakage, electric shock or fire. Contact your dealer.

The system must be repaired by a qualified service person:

Malfunction	Measure
If a safety device such as a fuse, a breaker or an earth leakage breaker frequently actuates or the ON/OFF switch does not properly work.	Turn off the main power switch.
If water leaks from the unit.	Stop the operation.
The operation switch does not workwell.	Turn off the power.
If the operation lamp flashes and the malfunction code appears on the user interface display.	Notify your installer and report the malfunction code.

If the system does not properly operate except for the abovementioned cases and none of the abovementioned malfunctions is evident, investigate the system according to the following procedures.

Malfunction	Measure
The remote controller display is off.	<ul style="list-style-type: none">• Check if there is no power failure. Wait until power is restored. If power failure occurs during operation, the system automatically restarts immediately after power is restored.• Check if no fuse has blown or breaker is activated. Change the fuse or reset the breaker if necessary.• Check if the benefit kWh rate power supply is active.
An error code is displayed on the remote controller.	Consult your local dealer. Refer to "4.1 Alarm List: Overview" for a detailed list of error codes.

Notes

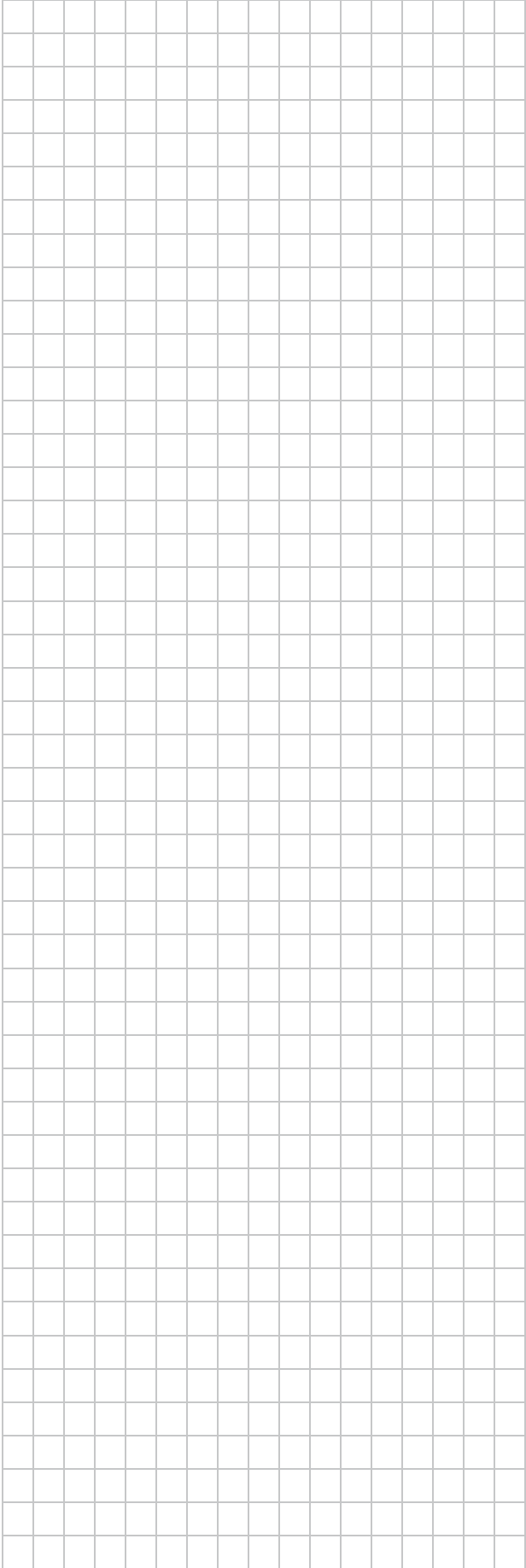
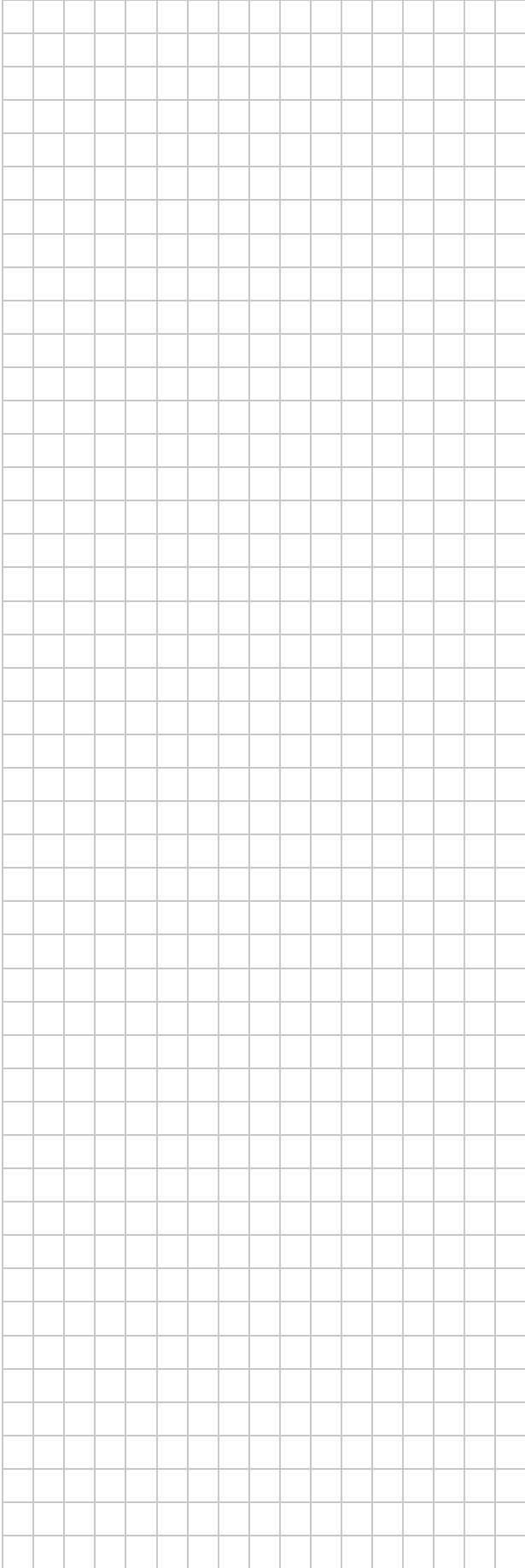

The present publication is drawn up by of information only and does not constitute an offer binding upon Daikin Applied Europe S.p.A.. Daikin Applied Europe S.p.A. has compiled the content of this publication to the best of its knowledge. No express or implied warranty is given for the completeness, accuracy, reliability, or fitness for particular purpose of its content, and the products and services presented therein. Specifications are subject to change without prior notice. Refer to the data communicated at the time of the order. Daikin Applied Europe S.p.A. explicitly rejects any liability for any direct or indirect damage, in the broadest sense, arising from or related to the use and/or interpretation of this publication. All content is copyrighted by Daikin Applied Europe S.p.A..

DAIKIN APPLIED EUROPE S.p.A.

Via Piani di Santa Maria, 72 - 00072 Ariccia (Roma) - Italia

Tel: (+39) 06 93 73 11 - Fax: (+39) 06 93 74 014

<http://www.daikinapplied.eu>