

DAIKIN



Public

REV	01
Date	10-2024
Supersedes	D-EOMAC01905-23_00EN

**CONTROL PANEL OPERATING MANUAL
D-EOMAC01905-23_01EN**

**Air cooled chiller with
inverter driven screw compressor**

MICROTECH CONTROLLER

TABLE OF CONTENTS

1	SAFETY CONSIDERATIONS	6
1.1	General	6
1.2	Before switching the unit	6
1.3	Avoid electrocution	6
2	GENERAL DESCRIPTION	7
2.1	Basic Information	7
2.2	Abbreviations used	7
2.3	Controller Operating Limits	7
2.4	Controller Architecture	7
2.5	Communication Modules	8
3	USING THE CONTROLLER	9
3.1	Navigating	9
3.2	Passwords	10
3.3	Editing	10
3.4	Mobile app HMI	10
3.5	Basic Control System Diagnostic	11
3.6	Controller maintenance	12
3.7	Optional Remote User Interface	12
3.8	Embedded Web Interface	13
4	WORKING WITH THIS UNIT	14
4.1	Chiller On/Off	14
4.1.1	Keypad On/Off	14
4.1.2	Scheduler and Silent mode functionalities	15
4.1.3	Network On/Off	15
4.2	Water Setpoints	15
4.3	Unit Mode	17
4.3.1	Energy Saving mode	17
4.4	Unit Status	18
4.5	Network Control	19
4.6	Thermostatic Control	20
4.7	Date/Time	21
4.8	Pumps	22
4.9	External Alarm	22
4.10	Power Conservation	23
4.10.1	Demand Limit	23
4.10.2	Current Limit	25
4.10.3	Setpoint Reset	25
4.10.3.1	Setpoint Reset by OAT	26
4.10.3.2	Setpoint Reset by External 4-20 mA signal	26
4.10.3.3	Setpoint Reset by Return	26
4.10.4	Softload	27
4.11	Electrical Data	28
4.12	Controller IP Setup	29
4.13	Daikin On Site	30
4.14	Heat Recovery	30
4.15	Rapid Restart	31
4.16	FreeCooling Hydronic (Cooling Only)	32
4.16.1	Glycol Free Freecooling	32
4.17	Antifreeze Heater	33
4.18	Glycol Tank Heater	33
4.19	Harmonic Filter (SAF)	34
4.20	Software Options	35
4.20.1	Changing the Password for buying new Software Options	36

4.20.2	Inserting the Password in a Spare Controller.....	36
4.21	Modbus MSTP	37
4.22	BACnet MSTP	38
4.23	BACnet IP	38
4.24	Energy Monitoring	39
5	ALARMS AND TROUBLESHOOTING	41
5.1	Unit Alerts.....	41
5.1.1	Bad Current Limit Input.....	41
5.1.2	Option1BoardCommFail – Optional board 1 communication fail	41
5.1.3	Bad Leaving Water Temperature Reset Input.....	41
5.1.4	Energy Meter Communication Fail.....	42
5.1.5	Evaporator Pump #1 Failure	42
5.1.6	Evaporator Pump #2 Failure	43
5.1.7	External Event	43
5.1.8	Password Over Time	44
5.1.9	Heat Recovery Entering Water Temperature sensor fault	44
5.1.10	Heat Recovery Leaving Water Temperature sensor fault	44
5.1.11	Heat Recovery Water Temperatures inverted.....	45
5.1.12	Evaporator differential pressure transducer sensor fault	45
5.1.13	System load differential pressure transducer sensor fault	45
5.1.14	Switch Box Temperature High	45
5.1.15	Switch Box Temperature sensor fault	46
5.1.16	Glycol leaving water temperature sensor fault	46
5.1.17	Glycol entering water temperature sensor fault	46
5.1.18	Glycol module communication fail	47
5.1.19	Glycol pump communication fail	47
5.1.20	Glycol pump alarm.....	47
5.1.21	Datacenter module temperature top PLC side sensor fault	48
5.1.22	Datacenter module temperature bottom PLC side sensor fault	48
5.1.23	Datacenter module temperature top 1 LH filter side sensor fault	48
5.1.24	Datacenter module temperature top 2 LH filter side sensor fault	49
5.1.25	Datacenter module temperature bottom LH filter side sensor fault	49
5.1.26	Datacenter module relative humidity sensor fault	49
5.1.27	Datacenter module communication fail	50
5.1.28	SAF communication fail	50
5.1.29	SAF High current	50
5.1.30	SAF High temperature	50
5.1.31	SAF High regulation card temperature	51
5.1.32	SAF Under voltage	51
5.1.33	SAF Over voltage	51
5.1.34	SAF Precharge Failure	52
5.1.35	SAF Precharge k1 Failure	52
5.1.36	SAF Precharge k2 Failure	52
5.1.37	SAF STO Fault	52
5.1.38	SAF STO Fault	53
5.2	Unit Pumpdown Stop Alarms	53
5.2.1	Evaporator Entering Water Temperature (EWT) sensor fault	53
5.2.2	Evaporator Water Temperatures inverted.....	53
5.2.3	Outside Air Temperature (OAT) Lockout	54
5.2.4	Outside Air Temperature sensor fault alarm	54
5.3	Unit Rapid Stop Alarms	54
5.3.1	Emergency Stop	54
5.3.2	Evaporator Flow Loss alarm	55
5.3.3	Evaporator Leaving Water Temperature (LWT) sensor fault	55

- 5.3.4 Evaporator Water Freeze alarm..... 55
- 5.3.5 External alarm..... 56
- 5.3.6 UnitOff CC1CommFail - Circuit 1 – CC1 Communication Error 56
- 5.3.7 UnitOff CC2CommFail - Circuit 2 – CC2 Communication Error 56
- 5.3.8 UnitOff Module1C1CommFail - Circuit 1 – Module1C1 Communication Error..... 57
- 5.3.9 UnitOff Module1C2CommFail - Circuit 2 – Module1C2 Communication Error..... 57
- 5.3.10 Heat Recovery Water Freeze Protect alarm 57
- 5.3.11 OptionCtrlrCommFail 58
- 5.3.12 Power Fault (only units with the UPS option)..... 58
- 5.3.13 PVM alarm..... 59
- 5.3.14 Glycol Water Freeze alarm 59
- 5.4 Circuit Alerts..... 59
 - 5.4.1 Economizer Pressure Sensor fault 59
 - 5.4.2 Economizer Temperature Sensor fault 60
 - 5.4.3 Failed Pumpdown 60
 - 5.4.4 Gas Leakage Sensor fault 61
 - 5.4.5 CxCmp1 MaintCode01 61
 - 5.4.6 CxCmp1 MaintCode02 61
 - 5.4.7 Power Loss..... 62
 - 5.4.8 Liquid Temperature sensor fault 62
 - 5.4.9 Liquid Pressure sensor fault 62
 - 5.4.10 SpeedTrol Fan Communication Error 63
 - 5.4.11 Cx Fans Communication Error..... 63
 - 5.4.12 Cx Fan Error 63
 - 5.4.13 Cx Fan Over V..... 64
 - 5.4.14 Cx Fan Under V..... 64
- 5.5 Circuit Pumpdown Stop Alarms..... 64
 - 5.5.1 Discharge Temperature Sensor fault 64
 - 5.5.2 Gas Leakage fault..... 65
 - 5.5.3 High Compressor Vfd Temperature fault 65
 - 5.5.4 Low Compressor Vfd Temperature fault 65
 - 5.5.5 Low Discharge Superheat fault..... 66
 - 5.5.6 Oil Pressure Sensor fault..... 66
 - 5.5.7 Antichatteting alarm 66
 - 5.5.8 Suction Temperature Sensor fault 67
- 5.6 Circuit Rapid Stop Alarms 67
 - 5.6.1 Compressor VFD Fault..... 67
 - 5.6.2 Compressor VFD OverTemp 67
 - 5.6.3 Compressor VFD Temperature high..... 68
 - 5.6.4 Compressor VFD A3 alarm..... 68
 - 5.6.5 Condensing Pressure sensor fault..... 68
 - 5.6.6 Evaporating Pressure sensor fault..... 69
 - 5.6.7 EXV Driver Error (A/C units only)..... 69
 - 5.6.8 Fail Start Low Pressure 69
 - 5.6.9 Fan VFD Over Current..... 70
 - 5.6.10 High Discharge Temperature Alarm 70
 - 5.6.11 High Motor Current Alarm 70
 - 5.6.12 High Motor Temperature Alarm 71
 - 5.6.13 High Oil Pressure Differential Alarm 71
 - 5.6.14 High Pressure alarm..... 71
 - 5.6.15 Low Pressure alarm..... 72
 - 5.6.16 Low Pressure Ratio Alarm 73
 - 5.6.17 Maximum Number of Restart Alarm..... 73
 - 5.6.18 Mechanical High Pressure Alarm..... 73

5.6.19	No Pressure At Start Alarm	74
5.6.20	No Pressure Change At Start Alarm	74
5.6.21	Overvoltage Alarm on input voltage	74
5.6.22	Overvoltage Alarm on DC rectified voltage	75
5.6.23	Undervoltage Alarm on input voltage	75
5.6.24	Undervoltage Alarm on DC rectified voltage	76
5.6.25	VFD Communication Failure	76
5.6.26	Fans Modbus Communication Failure	76
5.6.27	Fan Fault	77

1 SAFETY CONSIDERATIONS

1.1 General

Installation, start-up and servicing of equipment can be hazardous if certain factors particular to the installation are not considered: operating pressures, presence of electrical components and voltages and the installation site (elevated plinths and built-up up structures). Only properly qualified installation engineers and highly qualified installers and technicians, fully trained for the product, are authorized to install and start-up the equipment safely.

During all servicing operations, all instructions and recommendations, which appear in the installation and service instructions for the product, as well as on tags and labels fixed to the equipment and components and accompanying parts supplied separately, must be read, understood and followed.

Apply all standard safety codes and practices.

Wear safety glasses and gloves.



Do not operate on a faulty fan, pump or compressor before the main switch has been shut off. Overtemperature protection is auto-reset, therefore the protected component may restart automatically if temperature conditions allow it.

In some unit a push button is placed on a door of the unit electrical panel. The button is highlighted by a red color in yellow background. A manual pressure of the emergency stop button stops all loads from rotating, thus preventing any accident which may occur. An alarm is also generated by the Unit Controller. Releasing the emergency stop button enables the unit, which may be restarted only after the alarm has been cleared on the controller.



The emergency stop causes all motors to stop, but does not switch off power to the unit. Do not service or operate on the unit without having switched off the main switch.

1.2 Before switching the unit

Before switching on the unit read the following recommendations:

- When all the operations and all the settings have been carried out, close all the switchbox panels
- The switchbox panels can only be opened by trained personnel
- When the UC requires to be accessed frequently the installation of a remote interface is strongly recommended
- LCD display of the unit controller may be damaged by extremely low temperatures (see chapter 2.4). For this reason, it is strongly recommended to never power off the unit during winter, especially in cold climates.

1.3 Avoid electrocution

Only personnel qualified in accordance with IEC (International Electrotechnical Commission) recommendations may be permitted access to electrical components. It is particularly recommended that all sources of electricity to the unit be shut off before any work is begun. Shut off main power supply at the main circuit breaker or isolator.

IMPORTANT: This equipment uses and emits electromagnetic signals. Tests have shown that the equipment conforms to all applicable codes with respect to electromagnetic compatibility.



Direct intervention on the power supply can cause electrocution, burns or even death. This action must be performed only by trained persons.



RISK OF ELECTROCUTION: Even when the main circuit breaker or isolator is switched off, certain circuits may still be energized, since they may be connected to a separate power source.



RISK OF BURNS: Electrical currents cause components to get hot either temporarily or permanently. Handle power cable, electrical cables and conduits, terminal box covers and motor frames with great care.



In accordance with the operating conditions the fans can be cleaned periodically. A fan can start at any time, even if the unit has been shut down.

2 GENERAL DESCRIPTION

2.1 Basic Information

Microtech® is a system for controlling single or dual-circuit air/water-cooled liquid chillers. Microtech® controls compressor start-up necessary to maintain the desired heat exchanger leaving water temperature. In each unit mode it controls the operation of the condensers to maintain the proper condensation process in each circuit.

Safety devices are constantly monitored by Microtech® to ensure their safe operation. Microtech® also gives access to a Test routine covering all inputs and outputs.

2.2 Abbreviations used

In this manual, the refrigeration circuits are called circuit #1 and circuit #2. The compressor in circuit #1 is labelled Cmp1. The other in circuit #2 is labelled Cmp2. The following abbreviations are used:

A/C	Air Cooled
CEWT	Condenser Entering Water Temperature
CLWT	Condenser Leaving Water Temperature
CP	Condensing Pressure
CSRT	Condensing Saturated Refrigerant Temperature
DSH	Discharge Superheat
DT	Discharge Temperature
E/M	Energy Meter Module
EEWT	Evaporator Entering Water Temperature
ELWT	Evaporator Leaving Water Temperature
EP	Evaporating Pressure
ESRT	Evaporating Saturated Refrigerant Temperature
EXV	Electronic Expansion Valve
HMI	Human Machine Interface
MOP	Maximum operating pressure
SSH	Suction Superheat
ST	Suction Temperature
UC	Unit controller (Microtech)

2.3 Controller Operating Limits

Operation (IEC 721-3-3):

- Temperature -40...+70 °C
- Restriction LCD -20... +60 °C
- Restriction Process-Bus -25...+70 °C
- Humidity < 90 % r.h (no condensation)
- Air pressure min. 700 hPa, corresponding to max. 3,000 m above sea level

Transport (IEC 721-3-2):

- Temperature -40...+70 °C
- Humidity < 95 % r.h (no condensation)
- Air pressure min. 260 hPa, corresponding to max. 10,000 m above sea level.

2.4 Controller Architecture

The overall controller architecture is the following:

- One Microtech main controller
- I/O extensions as needed depending on the configuration of the unit
- Communications interface(s) as selected
- Peripheral Bus is used to connect I/O extensions to the main controller.

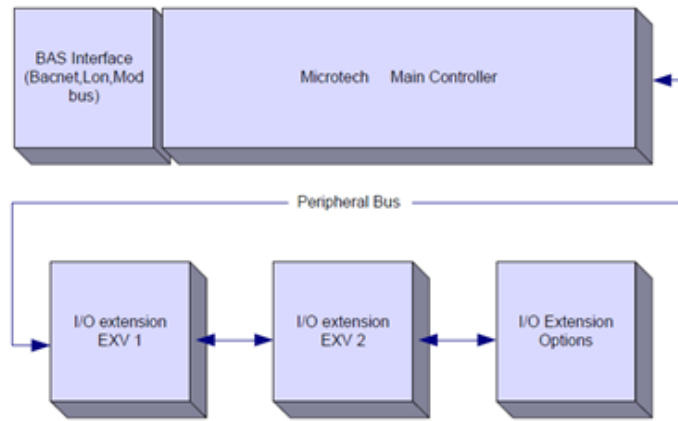

Maintain the correct polarity when connecting the power supply to the boards, otherwise the peripheral bus communication will not operate and the boards may be damaged.

2.5 Communication Modules

Any of the following modules can be connected directly to the left side of the main controller to allow a BAS or other remote interface to function. Up to three can be connected to the controller at a time. The controller should automatically detect and configure itself for new modules after booting up. Removing modules from the unit will require manually changing the configuration.

Module	Siemens Part Number	Usage
BacNet/IP	POL908.00/MCQ	Optional
Lon	POL906.00/MCQ	Optional
Modbus	POL902.00/MCQ	Optional
BACnet/MSTP	POL904.00/MCQ	Optional

3 USING THE CONTROLLER

Microtech 4 does not have an integrated HMI. The interaction with the controller can be done using a mobile app that can be download from the store (Playstore for Android devices and Apple Store for iOS devices).

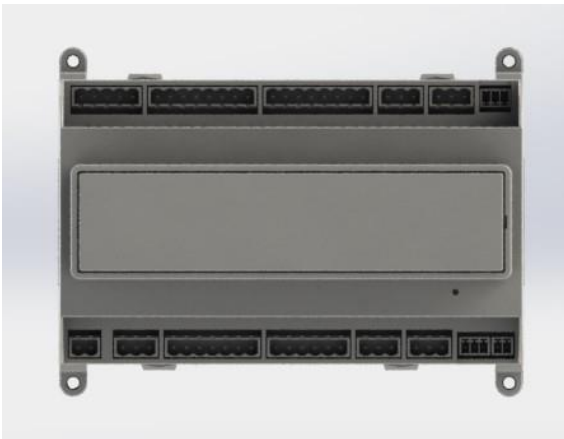

Optionally is possible to order the Remote HMI that can be connected to the available CE+ CE- port on the controller. This port is in the bottom connectors row of the controller.

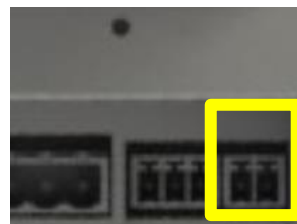

3.1 Navigating

When power is applied to the control circuit, the controller screen will be active and display the Home screen, which can also be accessed by pressing the Menu Button. An example of the HMI screens is shown in the following picture.

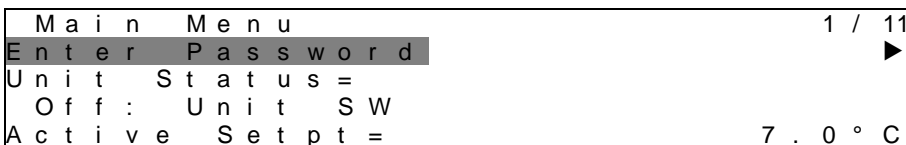

A bell ringing in the top right corner will indicate an active alarm. If the bell doesn't move it means that the alarm has been acknowledged but not cleared because the alarm condition hasn't been removed. A LED will also indicate where the alarm is located between the unit or circuits.

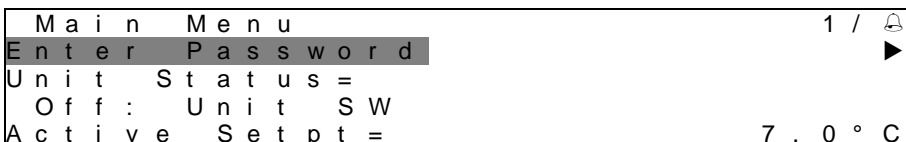

The active item is highlighted in contrast, in this example the item highlighted in Main Menu is a link to another page. By pressing the push'n'roll, the HMI will jump to a different page. In this case the HMI will jump to the Enter Password page.

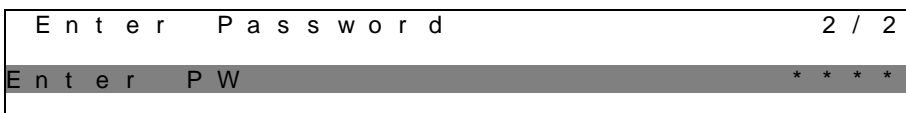

3.2 Passwords

The HMI structure is based on access levels that means that each password will disclose all the settings and parameters allowed to that password level. Basic information about the status can be accessed without the need to enter the password. The user UC handles two level of passwords:

USER	5321
MAINTENANCE	2526

The following information will cover all data and settings accessible with the maintenance password. User password will disclose a subset of the settings explained in chapter.

In the Enter Password screen, the line with the password field will be highlighted to indicate that the field on the right can be changed. This represents a setpoint for the controller. Pressing the push'n'roll the individual field will be highlighted to allow an easy introduction of the numeric password.

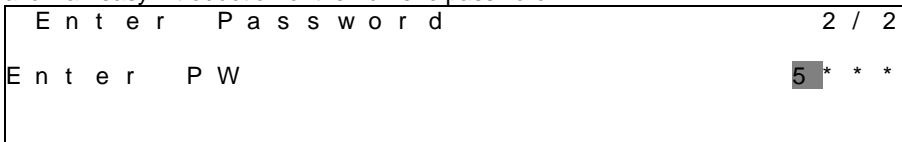

The password will time out after 10 minutes and is cancelled if a new password is entered or the control powers down. Entering an invalid password has the same effect as continuing without a password. It is changeable from 3 to 30 minutes via the Timer Settings menu in the Extended Menus.

3.3 Editing

The Editing Mode is entered by pressing the navigation wheel while the cursor is pointing to a line containing an editable field. Pressing the wheel again cause the new value to be saved and the keypad/display to leave the edit mode and return to the navigation mode.

3.4 Mobile app HMI

The Daikin mAP mobile app HMI is provided for free and aims to simplify the interaction with this Daikin product. The app can be downloaded from the official stores with the following links (scan the QR code to directly access the download pages on the stores).

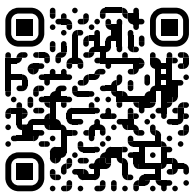

iOS

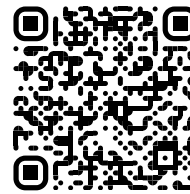

Android

To use the app is needed to pre-register an account and gain access to the specific unit to access. The access will be granted per unit base. A user can access multiple units after the app-tenant authorize this access. The procedure to register an account is in app. It's necessary to follow the sign in link in the app:

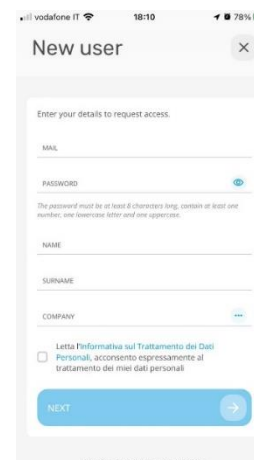
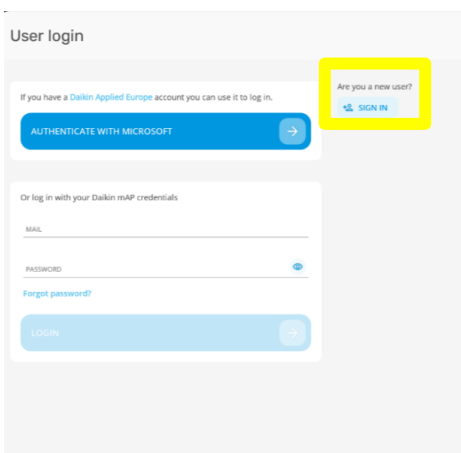

The mobile app will allow you to monitor all the relevant data, change the user related settings, trend data, update chiller software and more to come.

App layout will adapt based on the device where the app is running and will look as follows:



For further information consult the Quick Guide Daikin Map 1.0 - D-EPMAP00101-23_EN.

3.5 Basic Control System Diagnostic

Microtech controller, extension modules and communication modules are equipped with two status LED (BSP and BUS) to indicate the operational status of the devices. The BUS LED indicates the status of the communication with the controller. The meaning of the two status LED is indicated below.

Main Controller (UC)

BSP LED	Mode
Solid Green	Application running
Solid Yellow	Application loaded but not running (*) or BSP Upgrade mode active
Solid Red	Hardware Error (*)
Flashing Green	BSP startup phase. The controller needs time for starting.
Flashing Yellow	Application not loaded (*)
Flashing Yellow/Red	Fail safe mode (in case that the BSP upgrade was interrupted)
Flashing Red	BSP Error (software error*)
Flashing Red/Green	Application/BSP update or initialization

(*) Contact Service.

Extension modules

BSP LED	Mode	BUS LED	Mode
Solid Green	BSP running	Solid Green	Communication running, I/O working
Solid Red	Hardware Error (*)	Solid Red	Communication down (*)
Flashing Red	BSP Error (*)	Solid Yellow	Communication running but parameter from the application wrong or missing, or incorrect factory calibration
Flashing Red/Green	BSP upgrade mode		

Communication modules

BSP LED (same for all modules)

BSP LED	Mode
Solid Green	BPS running, communication with controller
Solid Yellow	BSP running, no communication with controller (*)
Solid Red	Hardware Error (*)
Flashing Red	BSP Error (*)
Flashing Red/Green	Application/BSP update

(*) Contact Service.

BUS LED

BUS LED	LON	Bacnet MSTP	Bacnet IP	Modbus
Solid Green	Ready for Communication. (All Parameter loaded; Neuron configured). Doesn't indicate a communication with other devices.	Ready for Communication. The BACnet Server is started. It doesn't indicate an active communication.	Ready for Communication. The BACnet Server is started. It doesn't indicate an active communication.	All Communication running

BUS LED	LON	Bacnet MSTP	Bacnet IP	Modbus
Solid Yellow	Startup	Startup	Startup. The LED stays yellow until the module receives a IP Address, therefore a link must be established.	Startup, or one configured channel not communicating to the Master
Solid Red	No Communication to Neuron (internal error, could be solved by downloading a new LON application).	BACnet Server down. Automatically a restart after 3 seconds is initiated.	BACnet Server down. Automatic restart after 3 seconds is initiated.	All configured Communications down. Means no communication to the Master. The timeout can be configured. In case that the timeout is zero the timeout is disabled.
Flashing Yellow	Communication not possible to the Neuron. The Neuron must be configured and set online over the LON Tool.			

3.6 Controller maintenance

The controller requires to maintain the installed battery. Every two years it's required to replace the battery. Battery model is: BR2032 and it is produced by many different vendors. To replace the battery, remove the plastic cover of the controller display using a screw driver as shown in the following pictures:

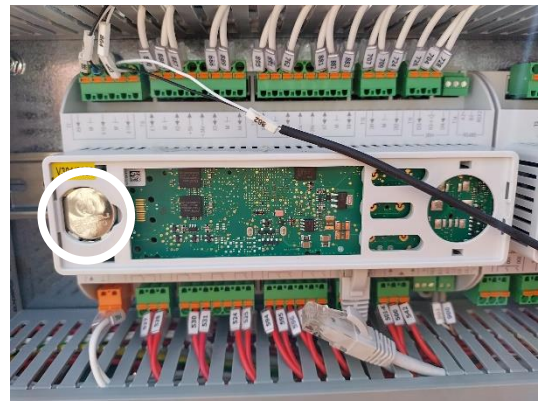

Be careful to avoid damages to the plastic cover. The new battery shall be placed in the proper battery holder, which is highlighted in the picture, respecting the polarities indicated into the holder itself.

3.7 Optional Remote User Interface

As an option an external Remote HMI can be connected on the UC. The Remote HMI offers the same features as the inbuilt display plus the alarm indication done with a light emitting diode located below the bell button.

All viewing and setpoint adjustments available on the unit controller are available on the remote panel. Navigation is identical to the unit controller as described in this manual.

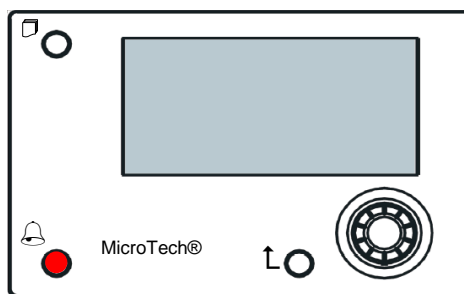

The Remote HMI can be extended up to 700m using the process bus connection available on the UC. With a daisy-chain connection as below, a single HMI can be connected to up to 8 units. Refer to the specific HMI manual for details.

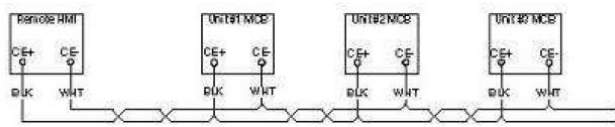

3.8 Embedded Web Interface

The Microtech controller has an embedded web interface that can be used to monitor the unit when connected to a local network. It is possible to configure the IP addressing of the Microtech as a fixed IP or DHCP depending on the network configuration.

With a common web browser, a PC can connect with the unit controller entering the IP address of the controller or the host name, both visible in the “About Chiller” page accessible without entering a password.

When connected, it will be required to enter a username and a password. Enter the following credential to get access to the web interface:

Username: Daikin
 Password: Daikin@web

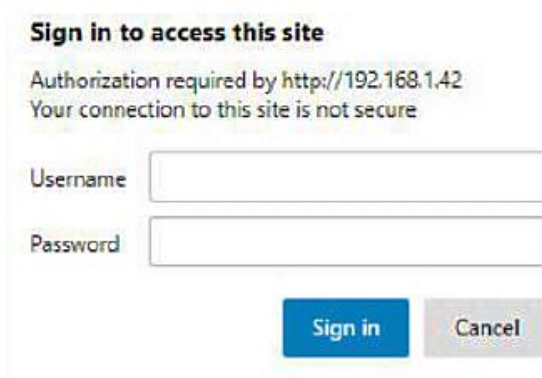

The Main Menu page will be displayed. The page is a copy of the onboard HMI and follows the same rules in terms of access levels and structure.

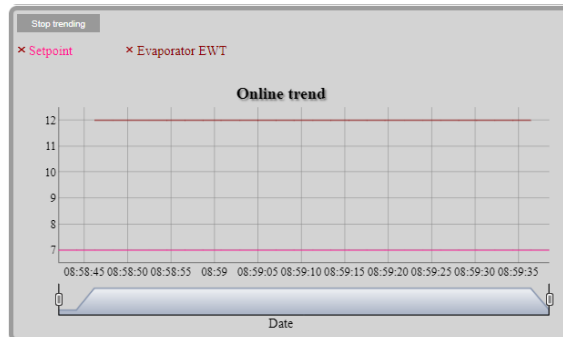
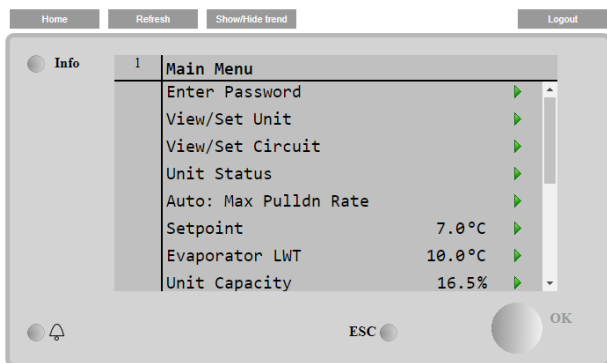

In addition, it allows to trend log a maximum of 5 different quantities. It's required to click on the value of the quantity to monitor and the following additional screen will become visible:

Depending on the web browser and its version the trend log feature may not be visible. It's required a web browser supporting HTML 5 like for example:

- Microsoft Internet Explorer v.11,
- Google Chrome v.37,
- Mozilla Firefox v.32.

These software are only an example of the browser supported and the versions indicated have to be intended as minimum versions.

4 WORKING WITH THIS UNIT

4.1 Chiller On/Off

Starting from factory setup, unit On/Off can be managed by the user using the selector **Q0**, placed in the electrical panel, which can switch between three positions: **0** – **Local** – **Remote**.

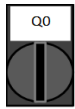

0 Unit is disabled



Loc (Local) Unit is enabled to start the compressors



Rem (Remote) Unit On/Off is managed through the “Remote On/Off” physical contact.
 Closed contact means unit enabled.
 Opened contact means unit disabled.
 Refer to the electrical wiring diagram, Field Wiring Connection page, to find the references about Remote On/Off contact. Generally, this contact is used to bring out from the electrical panel the on/off selector

Unit controller provides also additional software features to manage unit start/stop, that are set by default to allow unit start:

1. Keypad On/Off
2. Scheduler (Time programmed On/Off)
3. Network On/Off (optional with communication modules)

4.1.1 Keypad On/Off

In the main page, scroll down until **Unit Enable** menu, where are available all settings to manage unit and circuits start/stop.

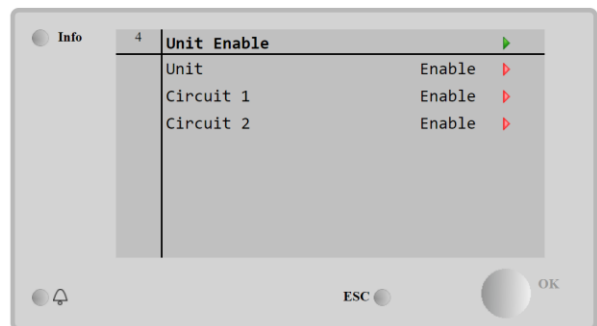
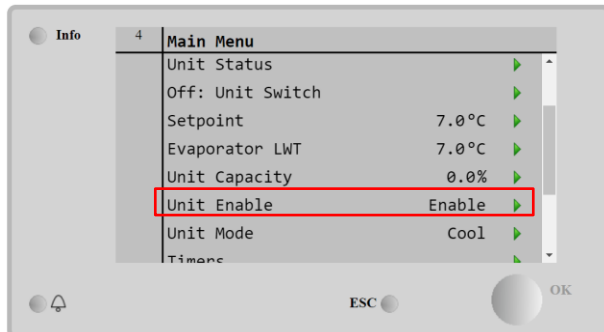

Parameter	Range	Description
Unit	Disable	Unit disabled
	Enable	Unit enabled
	Scheduler	Unit start/stop can be time programmed for each weekday
Circuit #X	Disable	Circuit #X disabled
	Enable	Circuit #X enabled
	Test	Circuit #X in test mode. This feature has to be used only from trained person or Daikin service

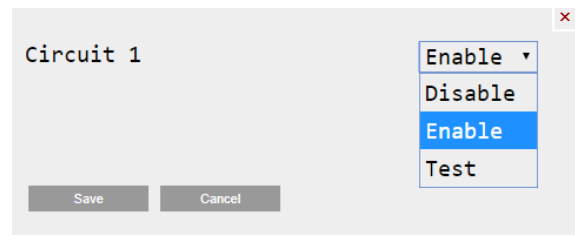
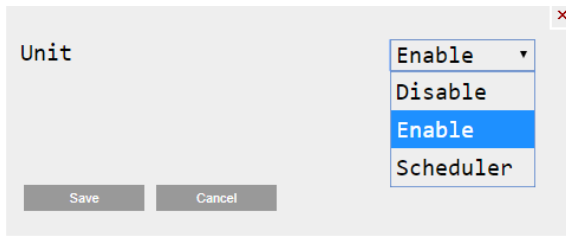

4.1.2 Scheduler and Silent mode functionalities

The Scheduler function can be used when is required an automatic chiller start/stop programming. To use this function, follow below instructions:

1. Q0 selector = Local
2. Unit Enable = Scheduler
3. Controller date and time properly set

Scheduler programming is available going in **Main Page → View/Set Unit → Scheduler menu**

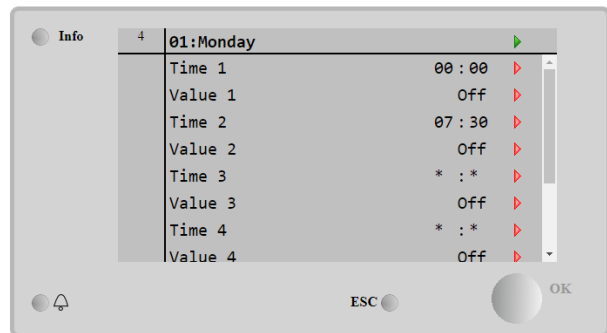
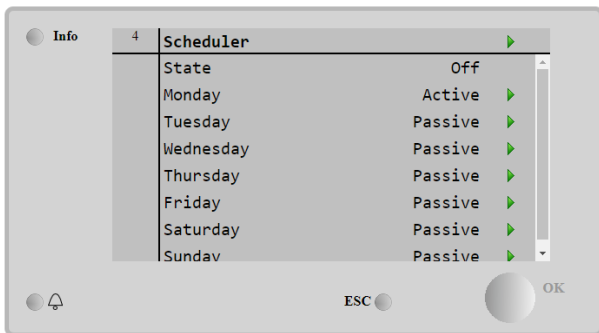

For each weekday can be programmed up to six-time bands with a specific operating mode. First operating mode starts at Time 1, ends at Time 2 when will start the second operating mode and so on until the latest.

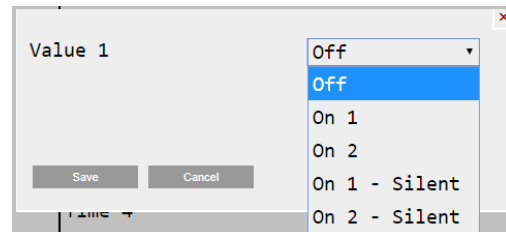

Depending on unit type, different operating modes are available:

Parameter	Range	Description
Value 1	Off	Unit disabled
	On Setpoint 1	Unit enabled – Water setpoint 1 selected
	On Setpoint 2	Unit enabled – Water setpoint 2 selected
	On 1 - Silent	Unit enabled – Water setpoint 1 selected – Fan silent mode enabled
	On 2 - Silent	Unit enabled – Water setpoint 2 selected – Fan silent mode enabled

When the **Fan Silent Mode** function is enabled the chiller noise level is reduced decreasing the maximum speed allowed for fans. Maximum Speed of Fans is reduced to 75% to reduce noise level.

4.1.3 Network On/Off

Chiller On/Off can be managed also with serial protocol, if the unit controller is equipped with one or more communication modules (BACNet, Modbus or LON). To control the unit over the network, follow below instructions:

1. Q0 selector = Local
2. Unit Enable = Enable
3. Control Source = Network
4. Close the contact Local/Network Switch, when required!

4.2 Water Setpoints

Purpose of this unit is to cool or to heat (in case of heat pump) the water temperature, to the setpoint value defined by the user and displayed in the main page:

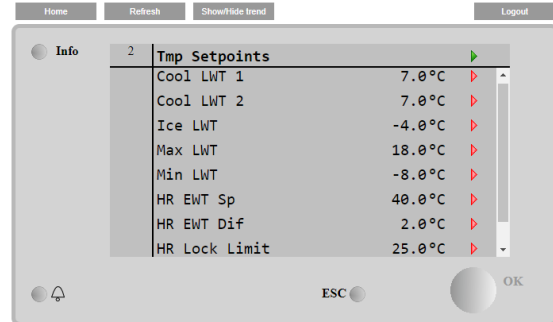
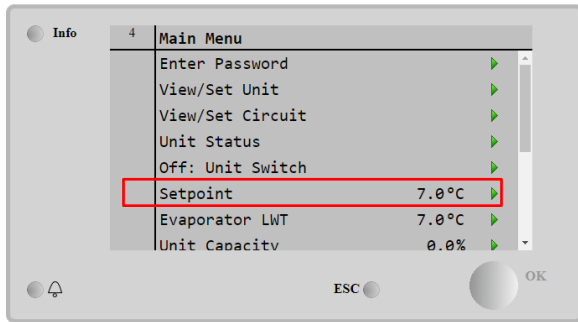

The unit can work with a primary or a secondary setpoint, that can be managed as indicated below:

1. Keypad selection + Double setpoint digital contact
2. Keypad selection + Scheduler Configuration
3. Network
4. Setpoint Reset function

As first step the primary and secondary setpoints need to be defined. From main menu, with user password, press on **Setpoint**.

Parameter	Range	Description
Cool LWT 1	Ranges of the Cool, Heat, Ice setpoint are reported in the IOM of every specific unit.	Primary cooling setpoint.
Cool LWT 2		Secondary cooling setpoint.
Ice LWT		Setpoint for Ice mode.
Max LWT		High limit for Cool LWT1 and Cool LWT2
Min LWT		Low limit for Cool LWT1 and Cool LWT2
HR EWT Sp		Heat Recovery Entering Water Setpoint
HR Dif		Heat Recovery Water Temperature differential
HR Lock Limit		Heat Recovery Lock Limit
HR Delta Sp		Heat Recovery Delta Setpoint

The change between primary and secondary setpoint can be performed using the **Double setpoint** contact, always available in the user terminal box, or through the **Scheduler** function.

Double setpoint contact works as below:

- Contact opened, the primary setpoint is selected
- Contact closed, the secondary setpoint is selected



When the scheduler function is enabled, the Double setpoint contact is ignored



When the operating mode Cool/Ice w/Glycol is selected, the Double Setpoint contact will be used to switch between the Cool and Ice mode, producing no change on the active setpoint

4.3 Unit Mode

The **Unit Mode** is used to define if the chiller is working to produce chilled or heated water. Current mode is reported in the main page to the item **Unit Mode**.

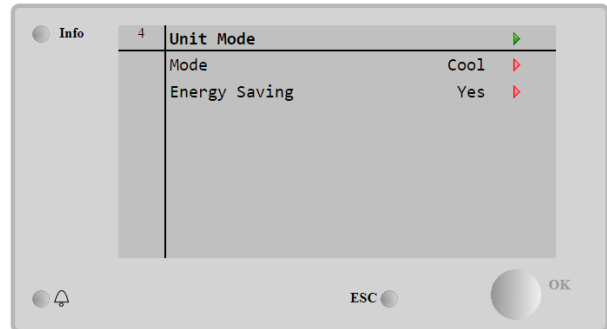
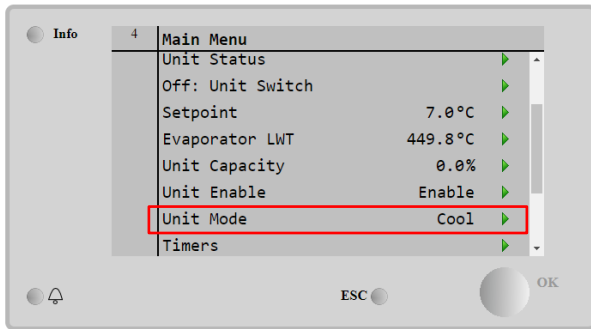

Depending on the unit type, different operating modes can be selected entering, with maintenance password, in the **Unit Mode** menu. In the table below are listed and explained all modes.

Parameter	Range	Description	Unit Range
Mode	Cool	Set if chilled water temperature up to 4°C is required. No glycol is generally needed in the water circuit, unless ambient temperature may reach low values.	A/C
	Cool w/Glycol	Set if chilled water temperature below 4°C is required. This operation requires proper glycol/water mixture in the evaporator water circuit.	A/C
	Cool/Ice w/Glycol	Set in case a dual cool/ice mode is required. The switch between the two modes is performed using the contact physical Double Setpoint. Double Setpoint opened: the chiller will work in cooling mode with the Cool LWT being as the Active Setpoint. Double Setpoint closed: The chiller will work in Ice mode with the Ice LWT as the Active Setpoint.	A/C
	Ice w/Glycol	Set if Ice storage is required. The application requires the compressors to operate at full load until the ice bank is completed, and then to stop for at least 12 hours. In this mode the compressor(s) will not operate at part load but will work only in on/off mode.	A/C
	Test	Enables the Manual Control of the unit. The manual test feature helps in debugging and checking the operational status of actuators. This feature is accessible only with the maintenance password in the main menu. To activate the test feature is required to disable the Unit from the Q0 switch and change the available mode to Test.	A/C
Energy Saving	No, Yes	Disable/Enable of the energy saving function	

Like the On/Off and setpoint control, also the unit mode can be modified from network.

4.3.1 Energy Saving mode

Some unit types provide the possibility to enable an energy saving function, that reduces the power consumption deactivating the compressors crankcase heater, when the chiller is Disabled.

This mode implies that the time needed to start the compressors, after an Off period, could be delayed until a maximum of 90 minutes.

For time critical application, the energy saving function can be disabled by the user to ensure the compressor start within 1 minute from unit On command.

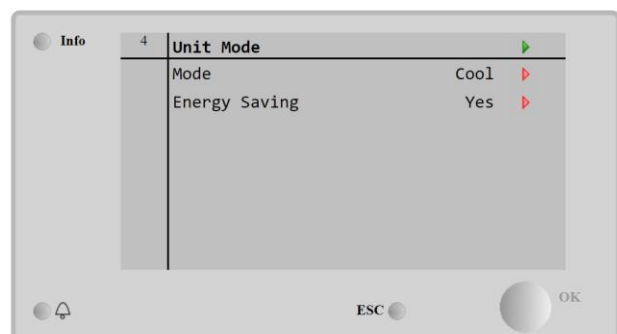
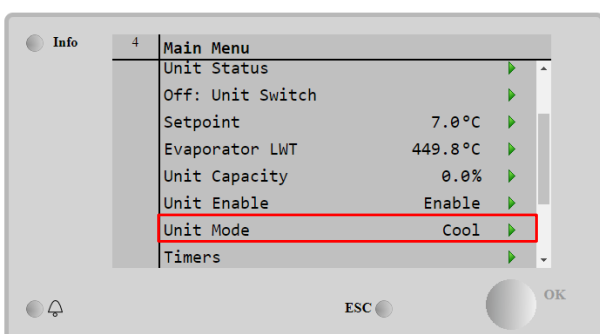

4.4 Unit Status

Unit controller provides in the main page some information about chiller status. All chiller states are listed and explained below:

Parameter	Overall status	Specific status	Description
Unit Status	Auto:		Unit is in Auto control. The pump is running and at least one compressor is running.
		wait For Load	Unit is in standby because the thermostatic control satisfies the active setpoint.
		Water Recirc	Water pump is running in order to equalize the water temperature in the evaporator.
		wait For Flow	Unit pump is running but the flow signal still indicates a lack of flow through the evaporator.
		Max Pulldown	Unit thermostatic control is limiting the unit capacity as the water temperature is dropping too quickly.
		Capacity Limit	Demand limit has been hit. Unit capacity will not further increase.
		Current Limit	Maximum current has been hit. Unit capacity will not further increase.
		Silent Mode	Unit is running and Silent Mode is enabled
		Pumpdown	Unit is performing the pumpdown procedure and it will stop within few minutes
	Off:	Master Disable	Unit is disabled by the Master Slave function
		Ice Mode Timer	This status can be shown only if the unit can work in Ice Mode. The unit is off because the Ice setpoint has been satisfied. Unit will remain off until the Ice Timer has expired.
		OAT Lockout	The unit cannot run because the Outside Air Temperature is below the limit foreseen for the condenser temperature control system installed in this Unit. If the Unit has to run anyway, check with your local maintenance how to proceed.
		Circuits Disabled	No circuit is available to run. All circuits can be disabled by their individual enable switch or can be disabled by a component safety condition active or can be disabled by keypad or can be all in alarms. Check the individual circuit status for further details.
		Unit Alarm	A unit alarm is active. Check the alarm list to see what the active alarm is inhibiting the unit to start and check if the alarm can be cleared. Refer to section 5. before proceeding.
		Keypad Disable	The Unit has been disabled by keypad. Check with your local maintenance if it can be enabled.
		Network Disabled	Unit is disabled by Network.
		Unit Switch	The Q0 selector is set to 0 or the or the Remote On/Off contact is opened.
		Test	Unit mode set to Test. This mode is activated to check operability of onboard actuators and sensors. Check with the local maintenance if the Mode can be reverted to the one compatible with unit application (View/Set Unit - Set-Up - Available Modes).
		Scheduler Disable	Unit is disabled by Scheduler programming

4.5 Network Control

When the unit controller is equipped with one or more communication modules the **Network Control** feature can be enabled, which gives the possibility to control the unit via serial protocol (Modbus , BACNet or LON).

To allow unit's control from network, follow below instructions:

1. Close the physical contact "Local/Network Switch". Refer to unit electrical wiring diagram, Field wiring Connection page, to find the references about this contact.
2. Go to **Main Page** → **View/Set Unit** → **Network Control**
Set **Control Source = Network**

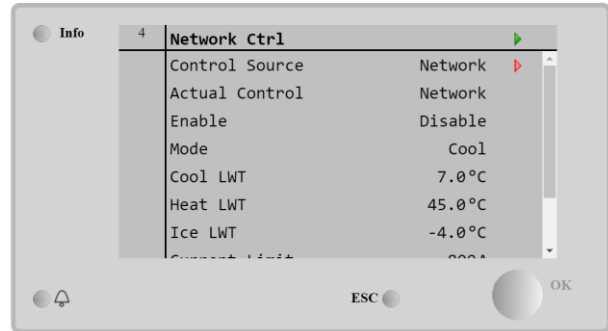
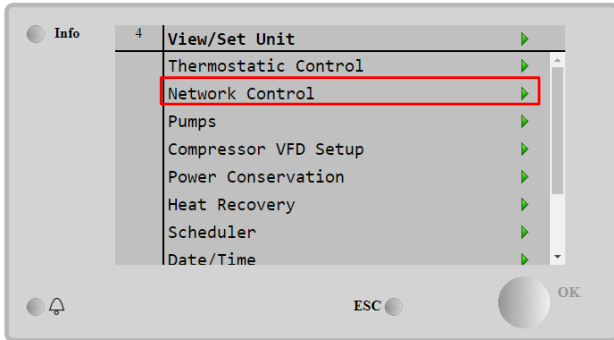

Network Control menu returns all main values received from serial protocol.

Parameter	Range	Description
Control Source	Local	Network control disabled
	Network	Network control enabled
Actual Control	Local, Network	Active control between Local/BMS.
Enable	-	On/Off command from network
Mode	-	Operating mode from network
Cool LWT	-	Cooling water temperature setpoint from network
Heat LWT	-	Heating water temperature setpoint from network
Ice LWT	-	Ice water temperature setpoint from network
Current Limit		Setpoint for current limitation from BMS
Capacity Limit	-	Capacity limitation from network
Remote Server		Remote servers enable

Refer to communication protocol documentation for specific registers addresses and the related read/write access level.

4.6 Thermostatic Control

Thermostatic control settings, allows to set up the response to temperature variations. Default settings are valid for most application, however plant specific conditions may require adjustments in order to have a smooth control or a quicker response of the unit.

The control will start the first compressor if the controlled temperature is higher (Cool Mode) or lower (Heat Mode) than the active setpoint of at least a Start Up DT value, whereas other compressors are started, step by step, if the controlled temperature is higher (Cool Mode) or lower (Heat Mode) than the active setpoint (AS) of at least a Stage Up DT (SU) value. Compressors stop if performed following same procedure looking to the parameters Stage Down DT and Shut Down DT.

	Cool Mode	Heat Mode
First compressor starts	Controlled Temperature > Setpoint + Start Up DT	Controlled Temperature < Setpoint - Start Up DT
Other compressors start	Controlled Temperature > Setpoint + Stage Up DT	Controlled Temperature < Setpoint - Stage Up DT
Last compressor stop	Controlled Temperature < Setpoint - Shut Dn DT	Controlled Temperature > Setpoint - Shut Dn DT
Other compressors stop	Controlled Temperature < Setpoint - Stage Dn DT	Controlled Temperature > Setpoint - Stage Dn DT

A qualitative example of compressors start-up sequence in cool mode operation is shown in the graph below.

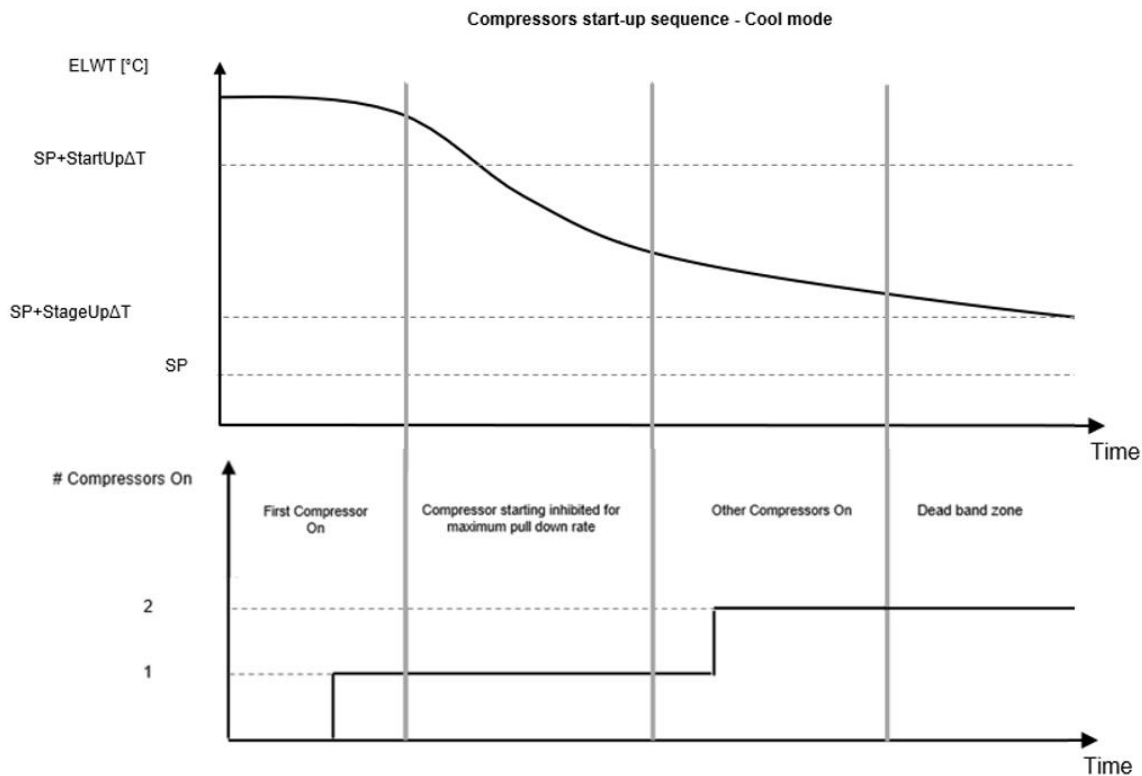

When controlled temperature is within the dead band (DB) error from the active setpoint (AS), unit capacity will not be changed.

If the leaving water temperature decreases below (Cool Mode) or rises above (Heat Mode) the active setpoint (AS), unit capacity is adjusted to keep it stable. A further decreasing (Cool Mode) or increasing (Heat Mode) of the controlled temperature of the Shut Down DT offset (SD) can cause circuit shutdown.

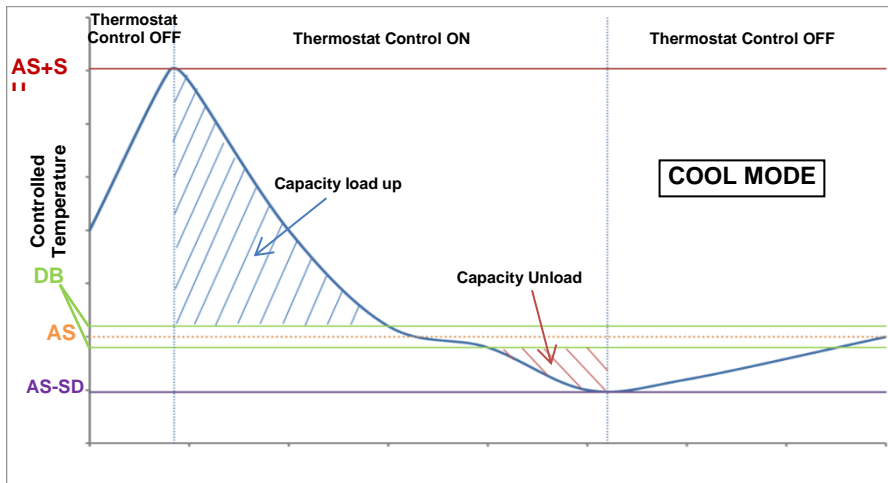

Thermostatic control settings are accessible from **Main Page** → **Thermostatic Control**

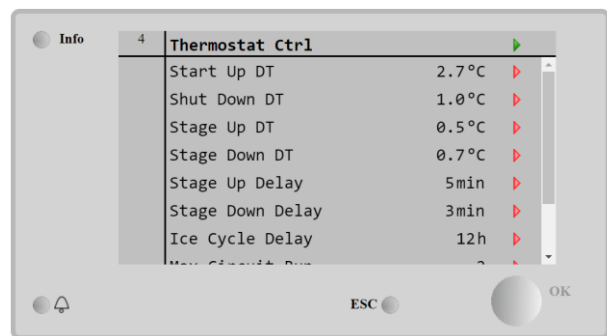
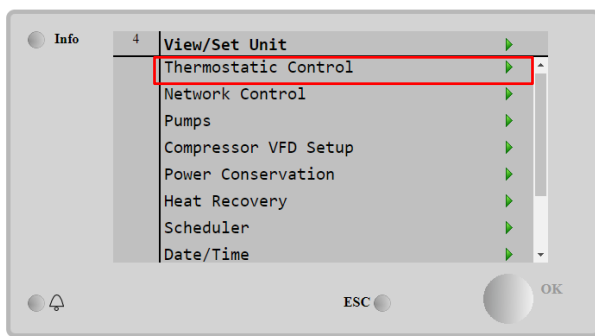

Parameter	Range	Description
Start Up DT	0-5 °C	Delta temperature respect the active setpoint to start the unit (startup of first compressor)
Shut Down DT	0-3 °C	Delta temperature respect the active setpoint to stop the unit (shutdown of latest compressor)
Stage Up DT	0-1.7 °C	Delta temperature respect the active setpoint to start a compressor
Stage Down DT	0-3 °C	Delta temperature respect the active setpoint to stop a compressor
Stage Up Delay	0-60 min	Minimum time between the compressors startup
Stage Down Delay	3-30 min	Minimum time between the compressors shutdown
Ice cycle Delay	1-23 h	Unit standby period during Ice mode operation
Max Circuits Run	1-2	Limit to the number of circuits to be used
Next Circuit On		Shows next circuit to be started up
Next Circuit Off		Shows next circuit number to be stopped

4.7 Date/Time

The unit controller can take stored the actual date and time, that are used for:

1. Scheduler
2. Cycling of standby chiller with Master Slave configuration
3. Alarms Log

Date and time can be modified going in **View/Set Unit** → **Date/Time**

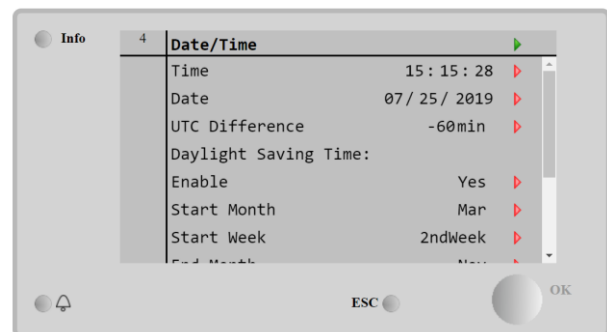
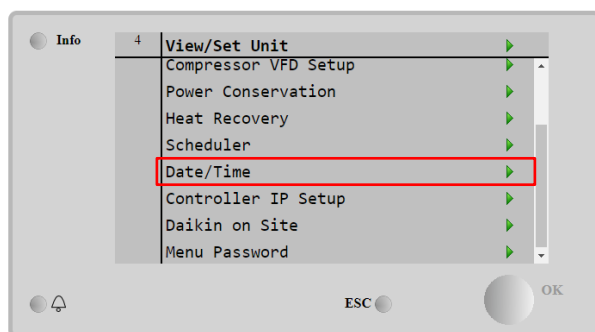

Parameter	Range	Description
Time		Actual date. Press to modify. Format is hh:mm:ss
Date		Actual time. Press to modify. Format is mm/dd/yy
Day		Returns the day of the week.
UTC Difference		Coordinated universal time.
Daylight Saving Time:		
Enable	No, Yes	It is used to enable/disable the automatic switch of the Daylight Saving Time
Start Month	NA, Jan...Dec	Daylight Saving time start month
Start week	1 st ...5 th week	Daylight Saving time start week
End Month	NA, Jan...Dec	Daylight Saving time end month
End week	1 st ...5 th week	Daylight Saving time end week



Remember to check periodically the controller battery in order to maintain updated date and time even when there is no electrical power. Refer to controller maintenance section.

4.8 Pumps

The UC can manage one or two water pumps for both evaporators. Number of pumps and their priority can be set from **Main Page**→**View/Set Unit**→**Pumps**.

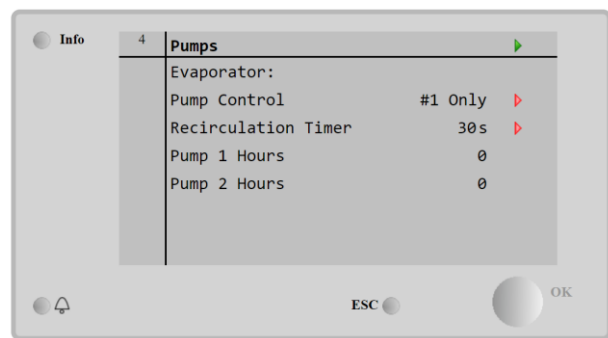
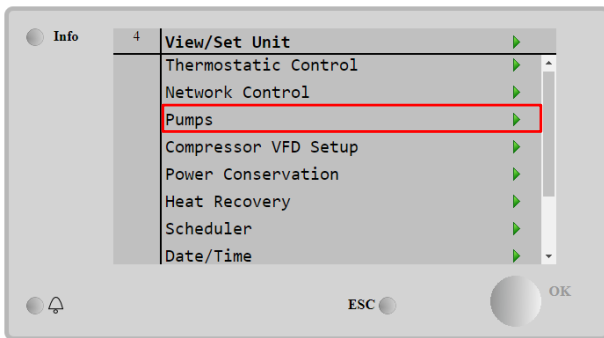

Parameter	Range	Description
Pump Control	#1 Only	Set to this in case of single pump #1 or twin pump with only #1 operational (f.e. in case of maintenance on #2)
	#2 Only	Set to this in case of twin pump with only #2 operational (f.e. in case of maintenance on #1)
	Auto	Set for automatic pump start management. At each chiller start, the pump with the least number of hours will be
	#1 Primary	Set to this in case of twin pump with #1 running and #2 as a backup
	#2 Primary	Set to this in case of twin pump with #2 running and #1 as a backup
Recirculation Timer		Minimum time required within flow switch has to in order to allow unit startup
Pump 1 Hours		Pump 1 running hours
Pump 2 Hours		Pump 2 running hours

4.9 External Alarm

The External Alarm is a digital contact that can be used to communicate to the UC an abnormal condition, coming from an external device connected to the unit. This contact is in the customer terminal box and depending on the configuration can causes a simple event in the alarm log or also the unit stop. The alarm logic associated to the contact is the following:

Contact state	Alarm State	Note
Opened	Alarm	The alarm is generated if the contact remains opened for at least 5 seconds
Closed	No Alarm	The alarm is reset just the contact is closed

The configuration is performed from the **Commissioning** → **Configuration** → **Options** menu

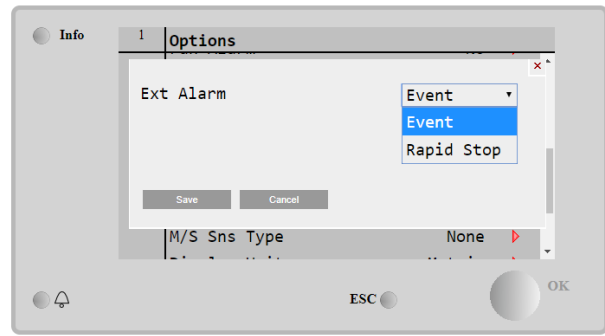
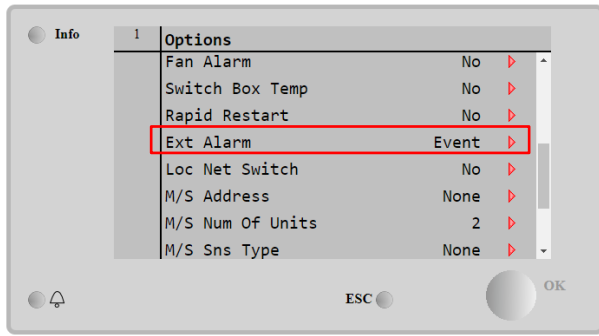

Parameter	Range	Description
Ext Alarm	Event	Event configuration generates an alarm in the controller but takes the unit running
	Rapid Stop	Rapid Stop configuration generates an alarm in the controller and performs a rapid stop of the unit



At the end of the Setpoint Reset configuration, execute an Apply Changes to make the configurations made effective.

4.10 Power Conservation

In this chapters will be explained the functions used to reduce the unit power consumption:

1. Demand Limit
2. Current Limit
3. Setpoint Reset
4. Softload

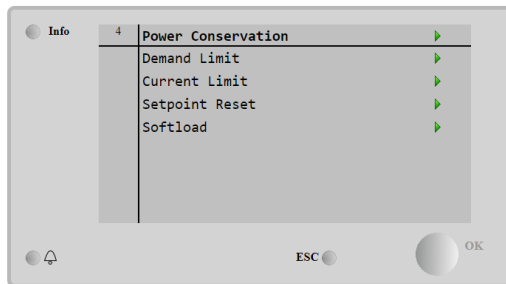

Main Menu→View / Set Unit→Power Conservation

4.10.1 Demand Limit

The “Demand Limit” function allows the unit to be limited to a specified maximum load. Capacity limit level is regulated using an external 4-20 mA signal with a linear relationship shown in the picture below. A signal of 4 mA indicates the maximum capacity available whereas a signal of 20 mA indicates the minimum capacity available. With demand limit function is not possible shutdown the unit but only unload it until minimum admissible capacity. Demand limit related setpoints available through this menu are listed in the table below.

To enable this option, go to **Main Menu → Commission Unit → Configuration → Options** and set the **Demand Limit** parameter to Enable.



At the end of the Setpoint Reset configuration, execute an Apply Changes to make the configurations made effective.

All info about this function is reported in the **Main Menu → View/set Unit → Power Configuration → Demand Limit** page.

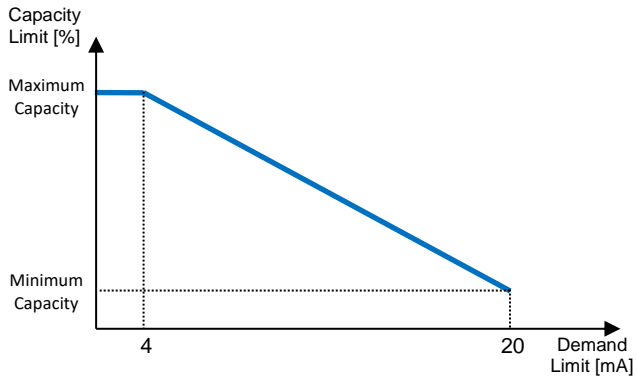
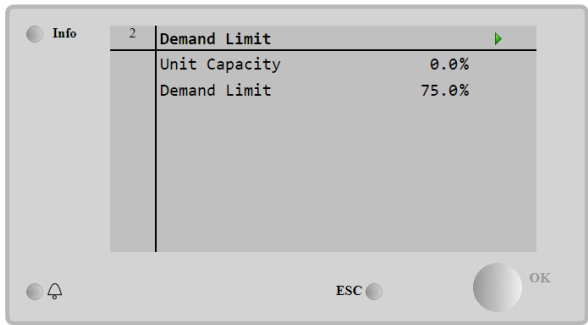
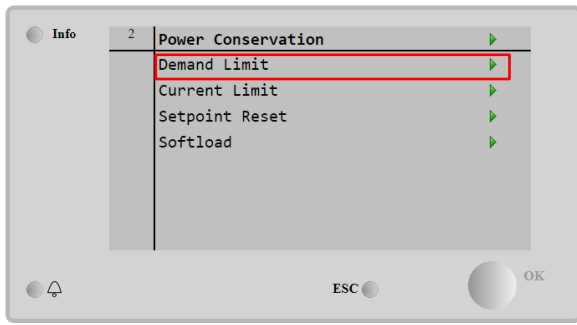

Parameter	Description
Unit Capacity	Displays current unit capacity
Demand Limit En	Enables demand limit
Demand Limit	Displays active demand limit

4.10.2 Current Limit

Current Limit function allows to control unit power consumption taking current drawn below a specific limit. If external digital signal is triggered, the function Current Limit is activated, and the user can set a Current Limit Setpoint defined through the HMI or BAS communication.

If Flexible Current Limit Option is activated, by **Commissioning → Configuration → Options → Flex Current Limit**, user can decrease the real limit using an external 4-20mA signal as indicate in the graph below. With 20 mA real current limit is set to Current Limit Setpoint, whereas with 4 mA signal the unit is unloaded until minimum capacity.

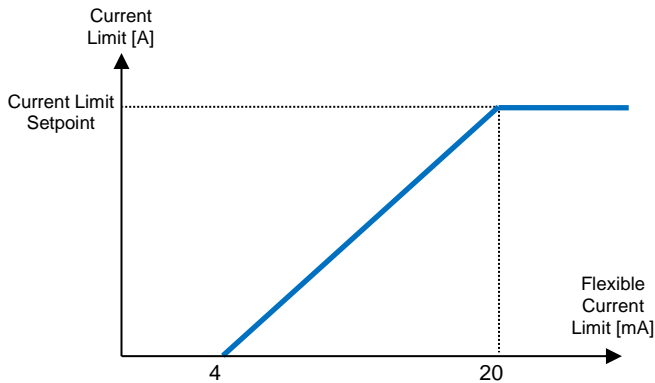

Parameter	Description
Unit Current	Actual Chiller Current
Current Limit	Active Current Limit
Current Setpoint	Current Setpoint. Overwrite by external 4-20 mA signal if Flex Curr Limit is activated.

All info about this function are reported in the **Main Menu → View/set Unit → Power Configuration → Current Limit** page.

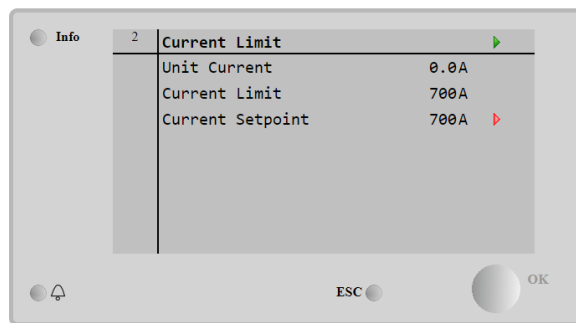
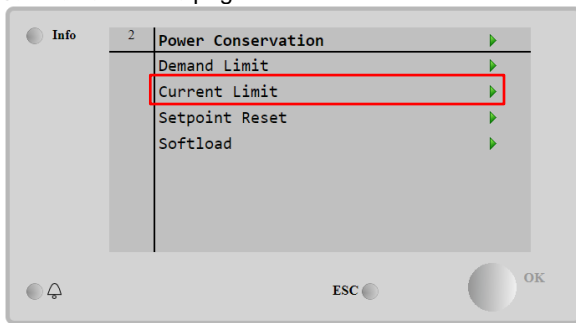

4.10.3 Setpoint Reset

The setpoint reset function overrides the chilled water temperature selected through the interface, when certain circumstances occur. This feature helps in reducing energy consumption optimizing comfort as well. Three different control strategies can be selected:

- Setpoint Reset by Outside Air Temperature (OAT)
- Setpoint Reset by an external signal (4-20mA)
- Setpoint Reset by Evaporator ΔT (Return)

To set the desired setpoint-reset strategy, go to **Main Menu → Commission Unit → Configuration → Options** and modify the **Setpoint Reset** parameter, according to the following table:

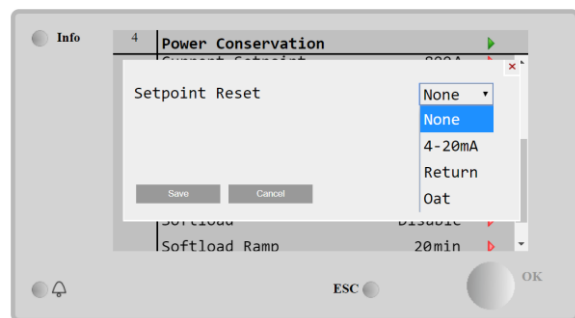
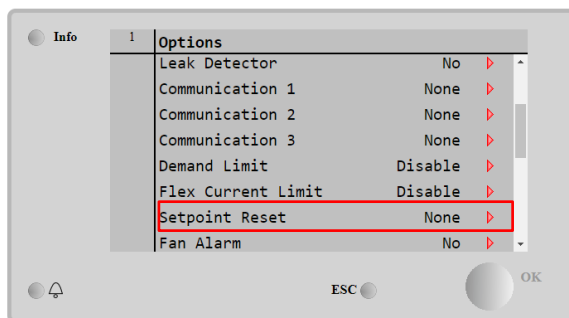

Parameter	Description
Max Reset	Max Setpoint Reset (valid for all active modes)
Start Reset DT	Used on Setpoint Reset by Evaporator DT
Max Reset OAT	See Setpoint Reset by OAT Reset
Strt Reset OAT	See Setpoint Reset by OAT Reset

Each strategy needs to be configured (although a default configuration is available) and its parameters can be set navigating to **Main Menu → View/Set Unit → Power Conservation → Setpoint Reset**.



At the end of the Setpoint Reset configuration, execute an Apply Changes to make the configurations made effective.

4.10.3.1 Setpoint Reset by OAT

The active setpoint is calculated applying a correction which is a function of ambient temperature (OAT). As temperature drops below the Start Reset OAT (SROAT), LWT setpoint is gradually increased until OAT reaches the Max Reset OAT (MROAT). Beyond this value, the LWT setpoint is increased by the Max Reset (MR) value.

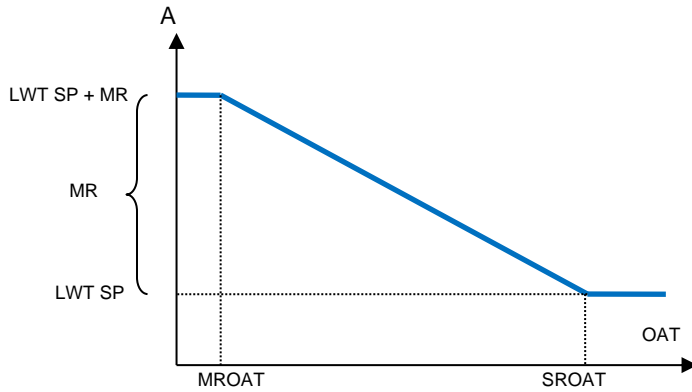

Parameter	Range
Max Reset (MR)	0.0°C ÷ 10.0°C
Start Reset DT	10.0°C ÷ 29.4°C
Max Reset OAT (MROAT)	10.0°C ÷ 29.4°C
Start Reset OAT (SROAT)	10.0°C ÷ 29.4°C

4.10.3.2 Setpoint Reset by External 4-20 mA signal

The active setpoint is calculated applying a correction based on an external 4-20mA signal. 4 mA corresponds to 0°C correction, while 20 mA corresponds to a correction of the active setpoint as set in Max Reset (MR).

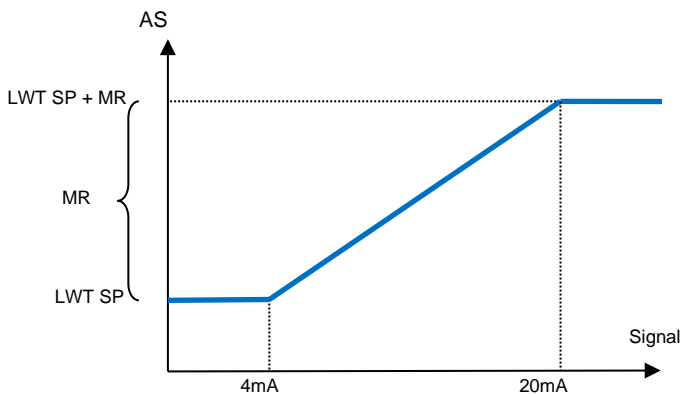

Parameter	Range
Max Reset (MR)	0.0°C ÷ 10.0°C
Start Reset DT	10.0°C ÷ 29.4°C
Max Reset OAT (MROAT)	10.0°C ÷ 29.4°C
Start Reset OAT (SROAT)	10.0°C ÷ 29.4°C

4.10.3.3 Setpoint Reset by Return

The active setpoint is calculated applying a correction that depends on the evaporator entering (return) water temperature. As evaporator ΔT becomes lower than the SR ΔT value, an offset to the LWT setpoint is increasingly applied, up to the MR value when the return temperature reaches the chilled water temperature.



The Return Reset may affect negatively the chiller operation when operated with variable flow. Avoid to use this strategy in case of inverter water flow control.

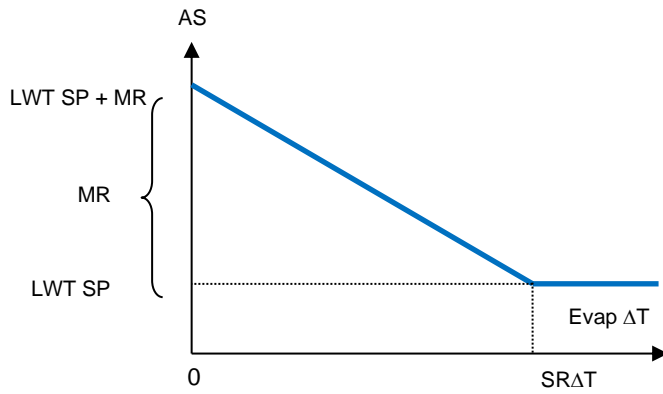

Parameter	Range
Max Reset (MR)	0.0°C ÷ 10.0°C
Start Reset DT	10.0°C ÷ 29.4°C
Max Reset OAT (MROAT)	10.0°C ÷ 29.4°C
Start Reset OAT (SROAT)	10.0°C ÷ 29.4°C

4.10.4 Softload

Soft Loading is a configurable function used to ramp up the unit capacity over a given time period, usually used to influence building electrical demand by gradually loading the unit. To enable Softload, go to the page:

Main Menu→View / Set Unit→Power Conservation→ Softload

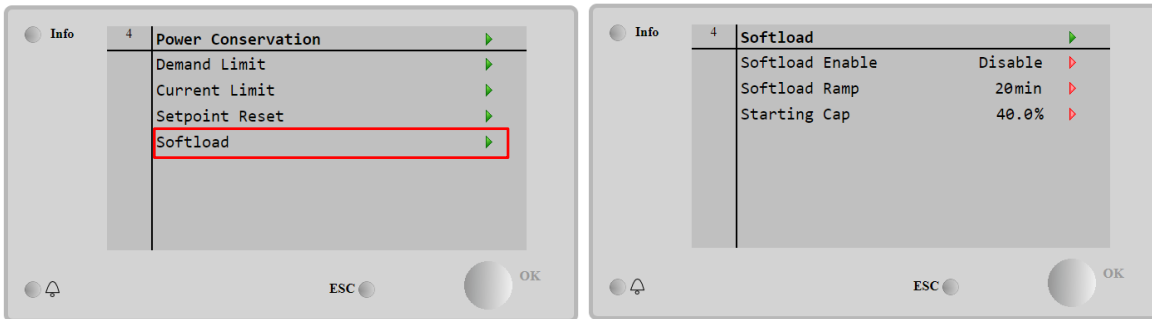

Once the Softload Ramp and the Starting Cap have been set, if the Softload is enabled, the machine is forced to ramp up the capacity based on settings. It works when the machine is starting from 0%, reaching the maximum load with the speed settable by the customer.

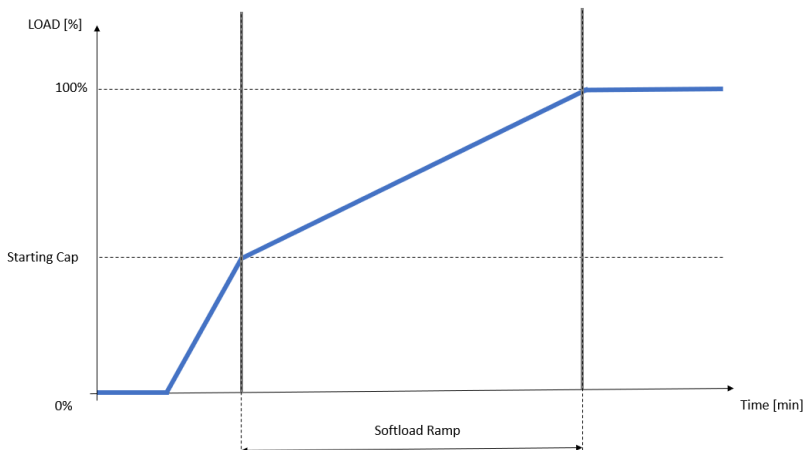

Parameter	Description
Softload Enable	Enables soft loading
Softload Ramp	Duration of the soft load ramp
Starting Cap	Begin capacity limit. Unit will increase capacity from this value to 100% over the time specified by the Softload Ramp setpoint.

If the Softload is enabled when the machine is already running, if the Starting Cap > Actual Capacity, the Softload will ramp up the Capacity with the speed set by the customer.

4.11 Electrical Data

Unit controller returns main electrical values read by the energy meter Nemo D4-L, Nemo D4-Le or NanoH. All data are collected in the menu **Electrical Data**.

Main Page → view/Set Unit → Electrical Data

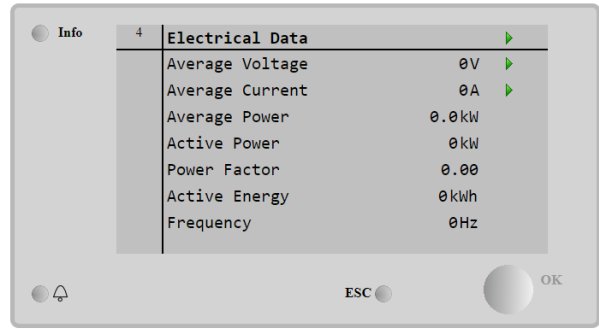
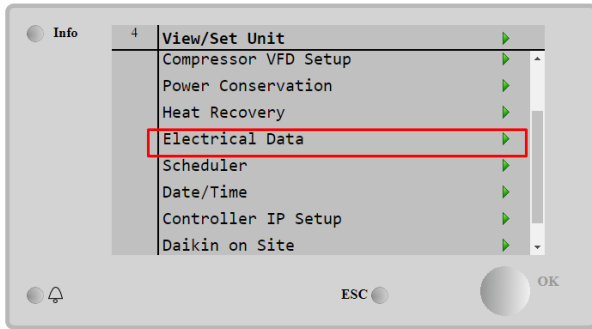

Parameter	Description
Average Voltage	Returns the average of the three chained voltages and links to the Voltage Data page
Average Current	Returns the current average and links to the Current Data page
Average Power	Returns the average power
Active Power	Returns the active power
Power Factor	Returns the power factor
Active Energy	Returns the active energy
Frequency	Returns the active frequency

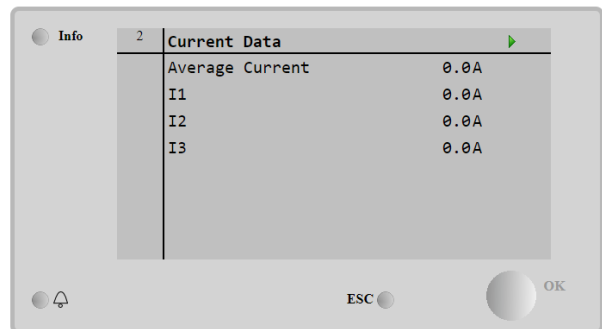
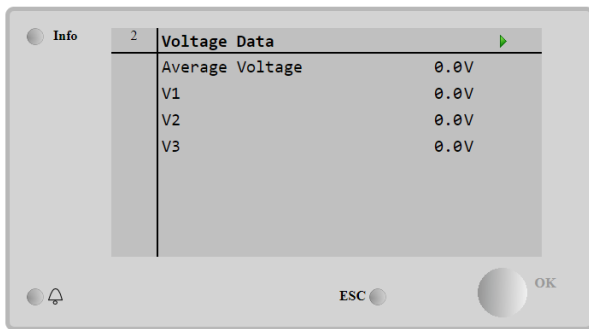

4.12 Controller IP Setup

The Controller IP Setup page is located at the path **Main Menu** → **View/Set Unit** → **Controller IP Setup**.

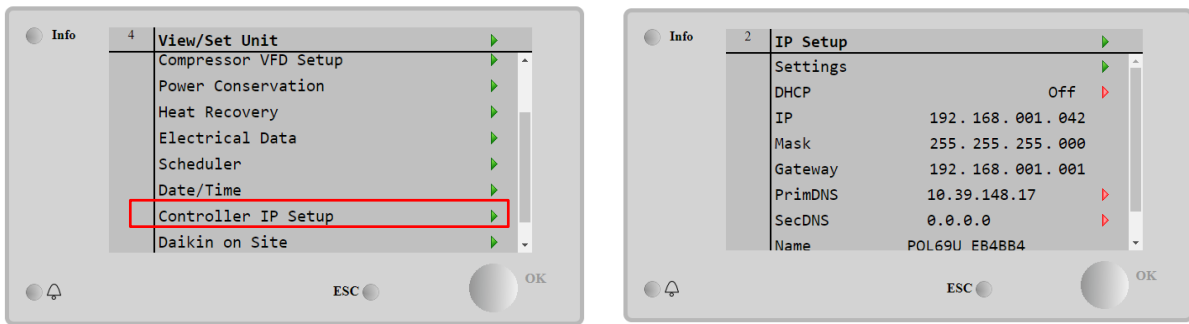

All the information about current MT4 IP Network settings is reported in this page, as shown in the following table:

Parameter	Range	Description
DHCP	On	The DHCP option is enabled.
	Off	The DHCP option is disabled.
IP	xxx.xxx.xxx.xxx	The current IP address
Mask	xxx.xxx.xxx.xxx	The current Subnet Mask address.
Gateway	xxx.xxx.xxx.xxx	The current Gateway address.
PrimDNS	xxx.xxx.xxx.xxx	The current Primary DNS address.
ScndDNS	xxx.xxx.xxx.xxx	The current Secondary DNS address.
Device	POLxxx_XXXXXX	The Host Name of the MT4 controller.
MAC	xx-xx-xx-xx-xx-xx	The MAC address of the MT4 controller.

To modify the MT4 IP Network configuration, do the following operations:

- access the **Settings** menu
- set the DHCP option to Off
- modify the IP, Mask, Gateway, PrimDNS and ScndDNS addresses, if needed, taking care of the current network settings
- set **Apply changes** parameter to **Yes** to save the configuration and restart the MT4 controller.

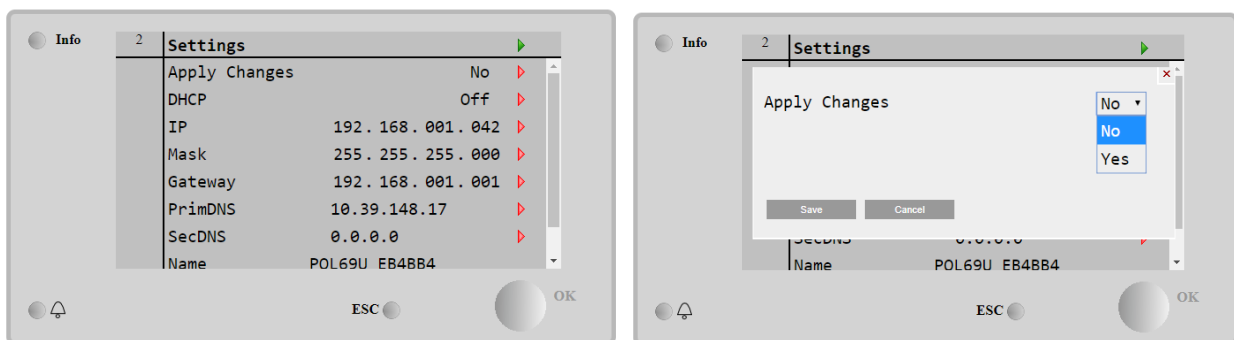

The default internet configuration is:

Parameter	Default Value
IP	192.168.1.42
Mask	255.255.255.0
Gateway	192.168.1.1
PrimDNS	0.0.0.0
ScndDNS	0.0.0.0

Note that if the DHCP is set to On and the MT4 internet configurations shows the following parameter values

Parameter	Value
IP	169.254.252.246
Mask	255.255.0.0
Gateway	0.0.0.0
PrimDNS	0.0.0.0
ScndDNS	0.0.0.0

then an internet connection problem has occurred (probably due to a physical problem, like the Ethernet cable breaking).

4.13 Daikin On Site

The Daikin on Site (DoS) page can be accessed navigating through **Main Menu → View/Set Unit → Daikin On Site**.

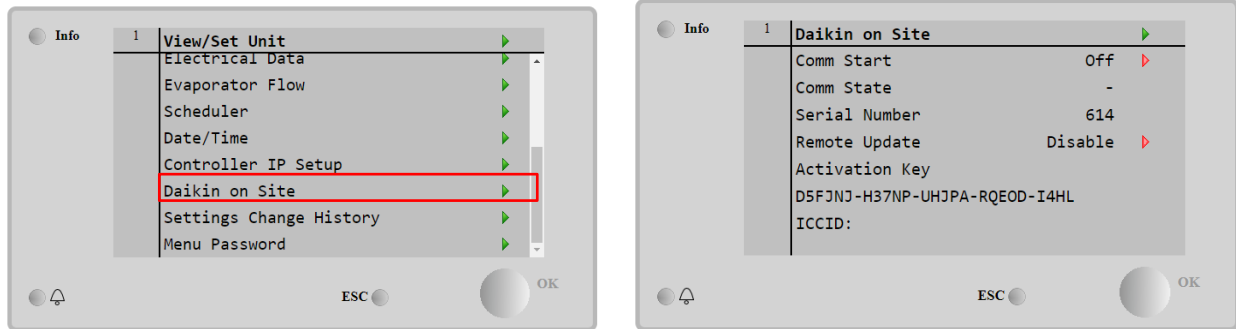

To use the DoS utility, the customer must communicate the **Serial Number** to Daikin company and subscribe to the DoS service. Then, from this page, it is possible to:

- Start/Stop the DoS connectivity
- Check the connection status to DoS service
- Enable/Disable the remote update option

according to the parameters shown into the table below.

Parameter	Range	Description
Comm Start	Off	Stop the connection to DoS
	Start	Start the connection to DoS
Comm State	-	Connection to DoS is off
	IPerr	Connection to DoS cannot be established
	Connected	Connection to DoS is established and working
Remote Update	Enable	Enable the Remote update option
	Disable	Disable the Remote update option

Among all the services provided by DoS, the **Remote Update** option allows to remotely update the software currently running on the PLC controller, avoiding an in-situ intervention of maintenance personnel. To this purpose, just set the Remote Update parameter to **Enable**. Otherwise, keep the parameter set to **Disable**.

In the unlikely event of PLC replacement, the DoS connectivity can be switched from the old PLC to the new one just communicating the current **Activation Key** to Daikin company.



For a successful remote software update, local service support is required, and a strong internet connection must be guaranteed.

4.14 Heat Recovery

The unit controller can handle a total or partial heat recovery option.

Some settings need to be properly set to match the specific plant requirements, going in **Main Page > View/Set Unit > Heat Recovery**.

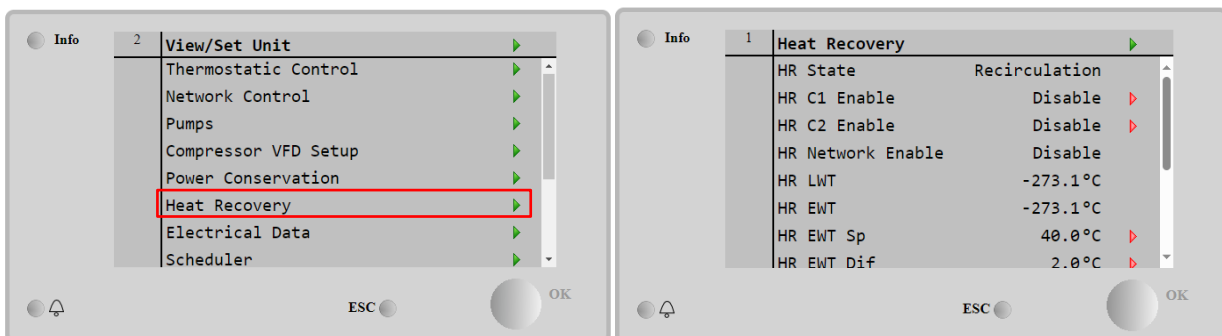

Parameter	Range	Description
HR State	Off	Heat recovery is disabled
	Recirculation	Heat recovery pump is running, but chiller fan is not regulating the heat recovery water temperature
	Regulation	Heat recovery pump is running and chiller fans are regulating the heat recovery water temperature
HR C1 Enable	Disable	Heat Recovery on C1 is disabled
	Enable	Heat Recovery on C1 is enabled
HR C2 Enable	Disable	Heat Recovery on C2 is disabled
	Enable	Heat Recovery on C2 is enabled
HR Network Enable	Disable	The Heat Recovery is disabled by Network
	Enable	The Heat Recovery is enabled by Network
HR LWT		Heat recovery leaving water temperature
HR EWT		Heat recovery entering water temperature
HR EWT Sp		Heat recovery entering water temperature setpoint value
HR EWT Dif		Heat recovery
HR Lock Limit		Heat Recovery Lock Limit
HR Delta Sp		Heat Recovery Delta Setpoint
HR 3-way Valve		Heat recovery 3-way valve opening percentage
HR Pumps		Heat recovery pump state
HR Pump Hours		Heat recovery pump running hours

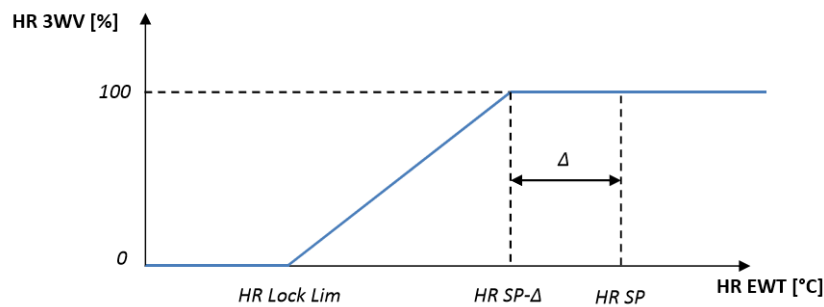

In case unit control source is "Network", to enable heat recovery functionality following conditions must be true:

- Enable the "HR C1 or C2 Enable" parameter in the Heat recovery page.
- Enable BMS register: Heat Recovery - Enable Setpoint

4.15 Rapid Restart

This chiller can activate a **Rapid Restart** (optional) sequence in reaction to a power failure. A digital contact is used to inform the controller that the feature is enabled. The feature is configured in the factory.

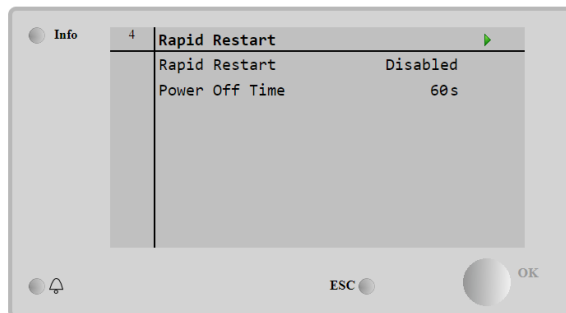
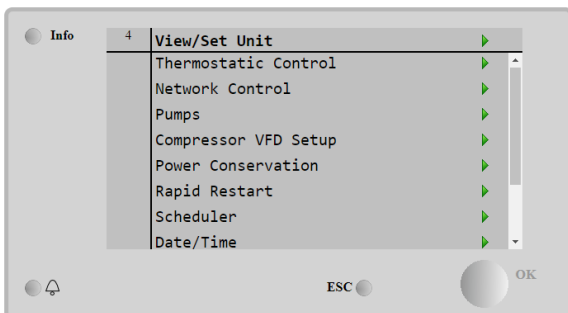

Rapid restart is activated under the following conditions:

- The power failure exists for up to 180 seconds
- The unit and circuit switches are ON
- No unit or circuit alarms exist
- The unit has been running in the normal Run state
- The BMS Circuit Mode setpoint is set to Auto when the control source is Network

If the power failure is more than 180 seconds, the unit will start based on the setting of the Stop-to-Start cycle timer (minimum setting of 3 minutes) and load per standard unit without Rapid Restart. When Rapid Restart is active, the unit will restart within 30 seconds of power restoration. The time to restore full load is less than 3 minutes.

4.16 FreeCooling Hydronic (Cooling Only)

Freecooling is started when the outside air temperature is lower than the entering water temperature by a predetermined freecooling delta T. Full freecooling will only be possible below a design temperature however logic will try to get the most out of the air temperature to optimize the overall performance of the chiller.

When freecooling is started, the freecooling valve is opened to let water pass through the freecooling coils and get cooled before entering the evaporator heat exchanger and go to the plant as leaving water temperature. Fans are started and then controlled to maintain the leaving water temperature to the active setpoint.

If the outside air temperature is not low enough to permit full freecooling and satisfy the plant load, the unit may start the mixed mode. In fact, if, with the fan at full speed, the leaving water temperature does not reach the active setpoint and remains above the Stage Up Temperature with a low slope, after a predetermined time a circuit can be started in mechanical mode. In this case, the fan speed will be adapted to control the minimum pressure ratio needed to guarantee the correct lubrication of compressors.

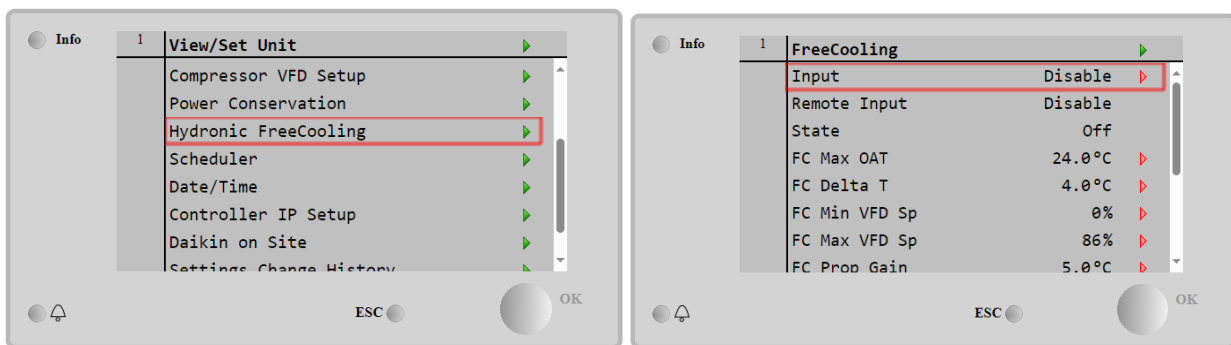

Parameter	Range	Description
Input	Disable	The Option is not enabled with all the inputs necessary
	Enable	The Option is correctly enabled
Remote Input	Disable	The Remote Input is not enabled with all the inputs necessary
	Enable	The Remote Input is correctly enabled
State	Off	Unit's State in Off
	Free Cooling	Unit State in Free Cooling mode, both Circuits run in Freecooling
	Mixed	Unit State in Mixed mode, one Circuit run in Freecooling and the second run in Mechanical mode
	Mechanical	Unit State in Mechanical mode, both Circuits run in Mechanical
FC Max Oat	10-30 °C	Maximum value for air temperature to enable the freecooling. Above this value the freecooling mode cannot be used.
FC Delta T	0-10 °C	Difference between entering water temperature and air temperature to enable the freecooling operations.
FC Min Pr	1.4-3	To adjust minimum pressure ratio for fans control.
FC Max Pr	1.4-3	To adjust maximum pressure ratio for fans control.
FC Min VFD Sp	5-50 %	To adjust minimum fan speed in freecooling mode.
FC Max VFD Sp	70-100 %	To adjust maximum fan speed in freecooling mode.

In order to enable the Freecooling functionality, the customer must set to **Enable** the "Input" parameter in the Freecooling page.

In case unit control source is "Network", to enable freecooling functionalities following conditions must be true:

- 1) Enable the "Input" parameter in the Freecooling page.
- 2) Enable BMS register: Freecooling - Enable Setpoint

4.16.1 Glycol Free Freecooling

The Glycol Free option in Freecooling condition is characterized with the presence of an intermediate water/water heat exchanger connected to a water loop with glycol. The main water loop will be glycol free to simplify the waste water

management. This kind of chillers require an additional pump to circulate the glycol in the freecooling closed loop which is linked to the main loop through an intermediate heat exchanger. This pump will be always active when freecooling is active, in case in of freezing in the closed loop or OAT Lockout.

So, in case of glycol free option, there are some additional datapoints respect the hydronic freecooling:

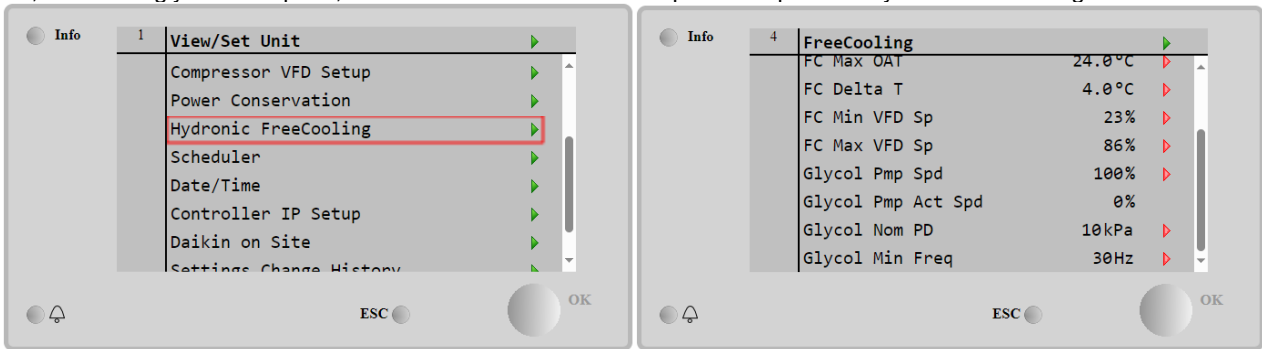

Parameter	Range	Description
Glycol Pmp Spd	0-100 %	Select nominal glycol pump's speed
Glycol Pmp Act Spd	0-100 %	Show the actual velocity of the glycol pump
Glycol Nom PD	1-200 kPa	Select nominal evaporator pressure drop corresponding at the rated flow rate
Glycol Min Freq	1-40 Hz	Select the minimum frequency of the glycol pump
Glycol DT ofs	0-15 °C	Select the additional offset to the Fc Delta T to enable the freecooling operations (during the transition mechanical Fc to mixed Fc)

4.17 Antifreeze Heater

The Antifreeze Heater page can be accessed navigating through **Main Menu** → **View/Set Unit** → **AntifreezeHeater**

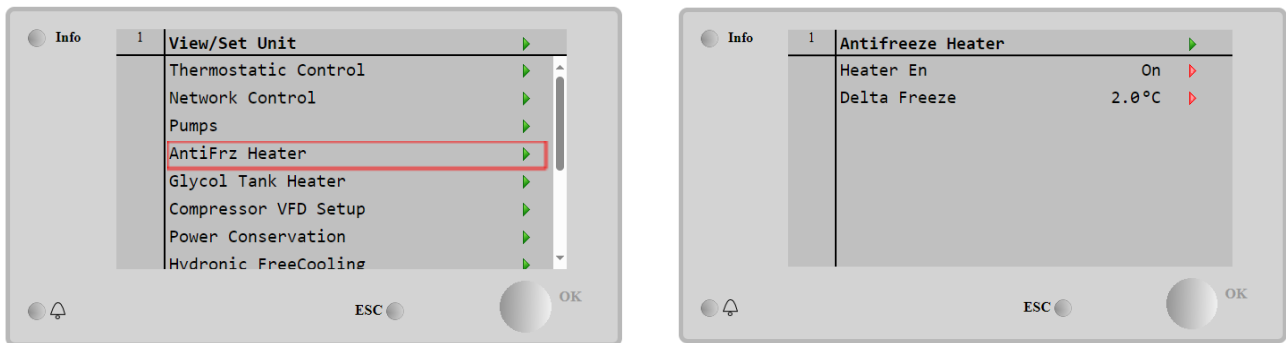

Parameter	Range	Description
Heater En	Off	The Option is not enabled.
	On	The Option is correctly enabled
Delta Freeze	-5 ÷ +5 °C	Difference between entering or leaving water temperature and freezing setpoint to enable the antifreeze heater.

In order Enable the Antifreeze Heater functionality, the customer must set to On the “Heater En” parameter in the Antifreeze Heater page.

4.18 Glycol Tank Heater

The Glycol Tank Heater page can be accessed navigating through **Main Menu** → **View/Set Unit** → **Glycol Tank Heater**

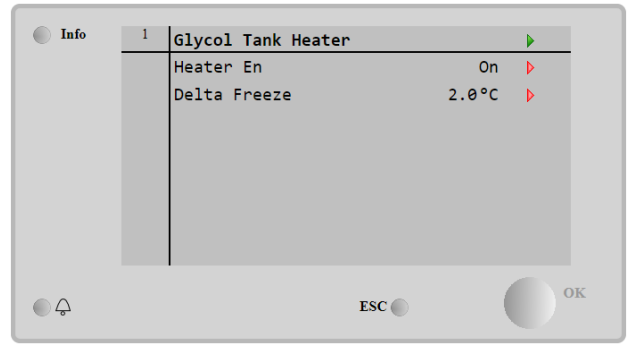
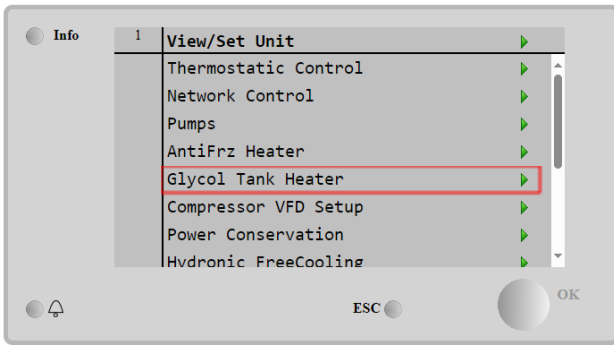

Parameter	Range	Description
Heater En	Off	The Option is not enabled.
	On	The Option is correctly enabled
Delta Freeze	-5 ÷ +5 °C	Difference between glycol entering or glycol leaving water temperature and glycol tank freezing setpoint to enable the glycol tank heater.

In order Enable the Glycol Tank Heater functionality, the customer must set to On the “Heater En” parameter in the Glycol Tank Heater page.

4.19 Harmonic Filter (SAF)

The Harmonic Filter (SAF) page can be accessed navigating through **Main Menu** → **View/Set Unit** → **Harmonic Filter**.

The active harmonic filter is a power quality device that dynamically delivers a controlled current that has the same amplitude as the harmonic current, which is injected in opposition to the harmonics present. This cancels the harmonic currents in the electrical system.

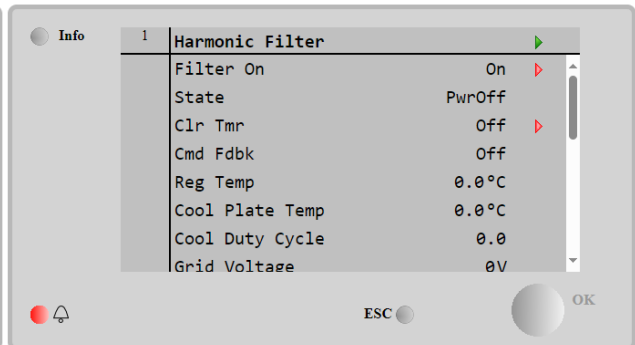
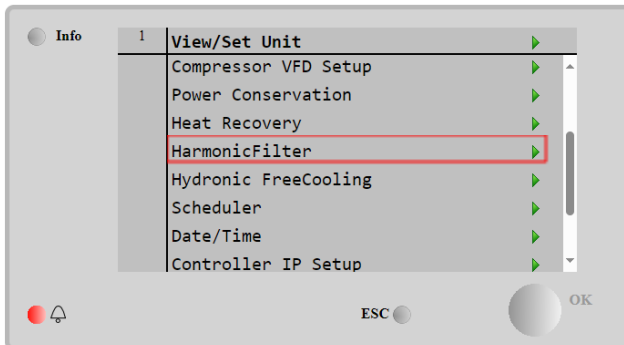

Parameter	Range	Description
Filter On	Off	The Option is not enabled.
	On	The Option is correctly enabled.
State	PwrOff	Power off (Waiting main supply)
	waitSSCmd	Waiting soft start command
	SSCmdOn	Soft start command On
	PreCON	Capacitors pre charge On
	PreCEnd	Capacitors pre charge End
	waitRUN	Waiting Run
	Run	SAF runs
	SAFAlms	SAF generic Alarms
	PCAlms	SAF Pre charge alarms
	NoState	No state available

Clr Tmr	off	Clear Timer Off
	On	Clear Timer On
Cmd Fdbk	Off	Command feedback Off
	On	Command feedback On
Reg Temp	°C	Regulation Card temperature
Cool Plate Temp	°C	SAF cooling plate temperature
Cool Duty Cycle		SAF cooling plate valve duty cycle
Grid voltage	V	Grid voltage
Grid THDi	%	Grid total harmonic distorsion (current)
Grid TDD	%	Grid total demand distorsion
Grid THDv	%	Grid total harmonic voltage distorsion
TDDi Ref	%	Total demand distorsion reference
Rel Hum	%real Hum	Related humidity sensor
Dew Temp	°C	Dew temperature calculated due the related humidity sensor
TbAF	°C	Temperature bottom sensor LH filter side
TbPLC	°C	Temperature bottom sensor PLC side
Tt1AF	°C	Temperature top 1 sensor LH filter side
Tt2AF	°C	Temperature top 2 sensor LH filter side
TtPLC	°C	Temperature top sensor PLC side
Compensation		Showed in related menu all the single compressor harmonics

Main Menu → View/Set Unit → Harmonic Filter → Compensation

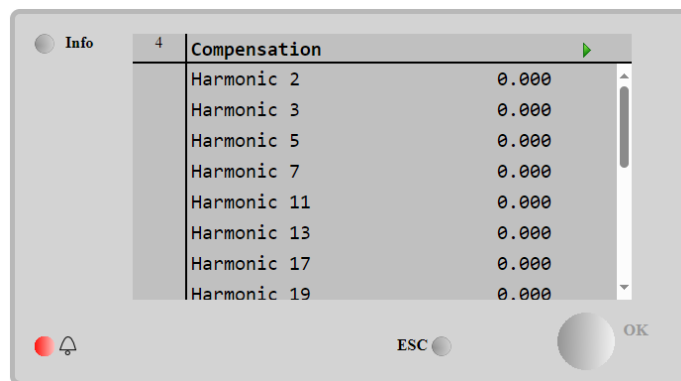

In order Enable the SAF functionality, the customer must set to On the "Filter On" parameter in the Harmonic Filter page.

4.20 Software Options

The possibility to employ a set of software options has been added to the functionality of the chiller, in according with Microtech 4 installed on the Unit. The Software Options do not require any additional hardware and regard communication channels and the new energy functionalities.

During the commissioning the machine is delivered with the Option Set chosen by the customer; the Password inserted is permanent and depends on the Serial Machine Number and the Option Set selected.

To check the current Option Set:

Main Menu → Commission Unit → Configuration → Software Options

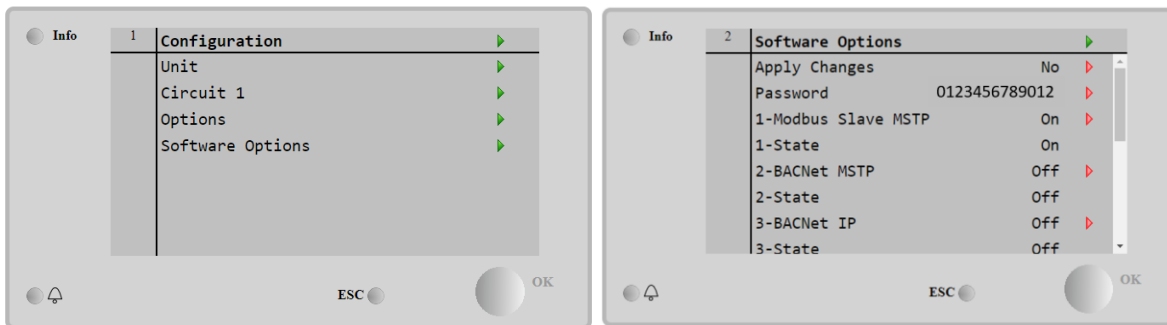

Parameter	Description
Password	Writable by Interface/Web Interface
Option Name	Option Name
Option Status	Option is activated. Option is not activated

The Current Password inserted activates the selected options.

4.20.1 Changing the Password for buying new Software Options

The option set and the Password are updated in the Factory. If the customer wants to change its Option Set, he needs to contact the Daikin Personnel and asks for a new password.

As soon as the new password is communicated, the follow steps allow the customer to change the Option Set by himself:

1. Wait for the circuits are both OFF, then, from the Main Page, **Main Menu→Unit Enable→Unit→Disable**
2. Go to **Main Menu→Commission Unit→Configuration→Software Options**
3. Select the Options to Activate
4. Insert the Password
5. Wait for the States of the selected options going to On
6. **Apply Changes→Yes** (it will reboot the controller)



The Password is changeable only if the machine is working in safe conditions: both the circuits are in the State Off.

4.20.2 Inserting the Password in a Spare Controller

If the Controller is broken and/or it needs to be replaced for any reason, the customer needs to configure the Option Set with a new Password.

If this replacement is scheduled, the customer can ask to Daikin Personnel for a new Password.

If there is not enough time to ask for a Password to Daikin Personnel (ex. an expected failure of the controller), a set of Free Limited Password is provided, in order not to interrupt the machine's working.

These Passwords are free and visualized in:

Main Menu→Commission Unit→Configuration→Software Options→Temporary Passwords

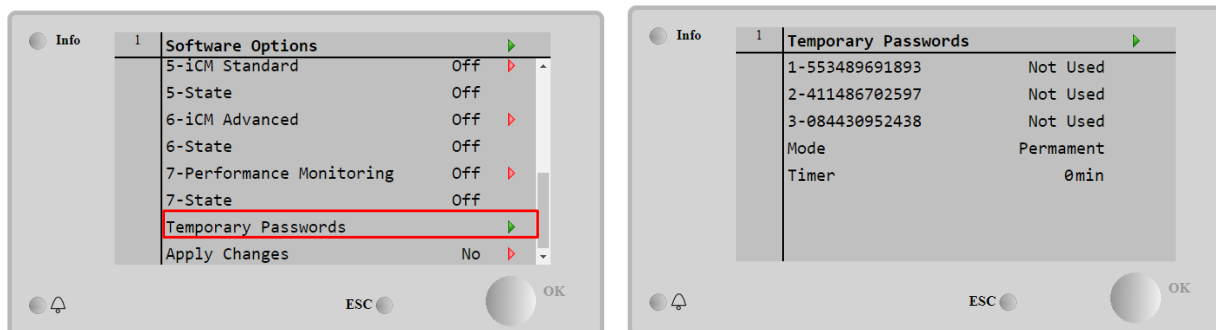

Their Use is limited up to three months:

- 553489691893 – 3 Months Duration
- 411486702597 – 1 Month Duration
- 084430952438 – 1 Month Duration

It gives the customer the time enough to contact Daikin Service and insert a new unlimited password.

Parameter	Specific Status	Description
-----------	-----------------	-------------

553489691893		Activate the Option Set for 3 Months.
411486702597		Activate the Option Set for 1 Month.
084430952438		Activate the Option Set for 1 Month.
Mode	Permanent	A permanent Password is inserted. Option set can be used for unlimited time.
	Temporary	A temporary Password is inserted. Option set can be used depending on the password inserted.
Timer		Last duration of the Option Set activated. Enabled only if the mode is Temporary.



The Password is changeable only if the machine is working in safe conditions: both the circuits are in the State Off.

4.21 Modbus MSTP

When the software option "Modbus MSTP" is activated and the controller is restarted, the communication protocol settings page can be accessed via the path:

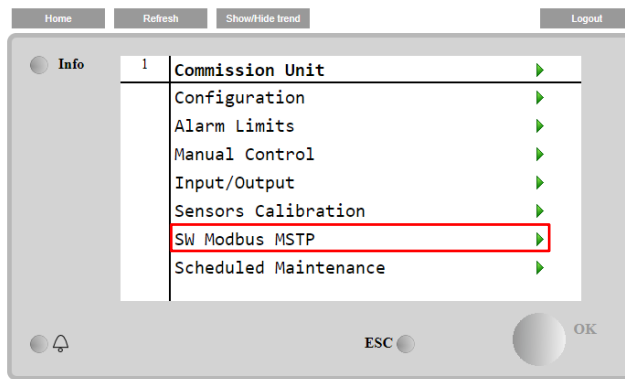

Main Menu→Commission Unit→SW Modbus MSTP

The values that can be set are the same as those found on the Modbus MSTP option page with the relative driver and depend on the specific system where the unit is installed.

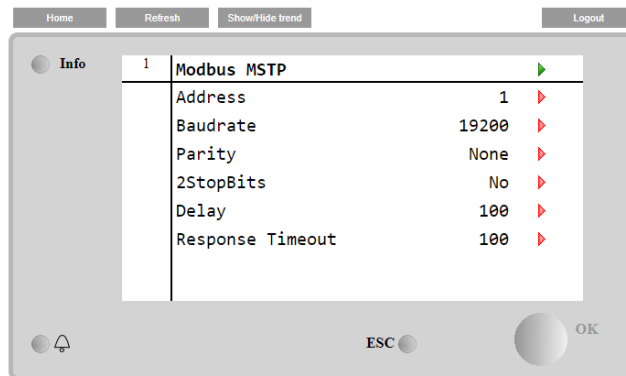

To establish the connection, the RS485 port to use is the one on the T14 terminal of the MT4 controller.

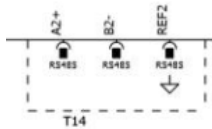

4.22 BACnet MSTP

When the software option "BACnet MSTP" is activated and the controller is restarted, the communication protocol settings page can be accessed via the path:

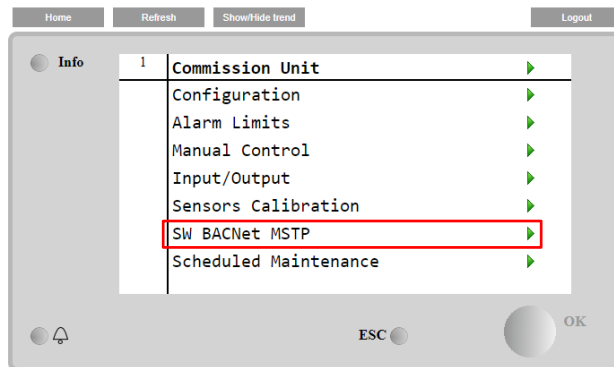

Main Menu→Commission Unit→SW BACnet MSTP

The values that can be set are the same as those found on the BACnet MSTP option page with the relative driver and depend on the specific system where the unit is installed.

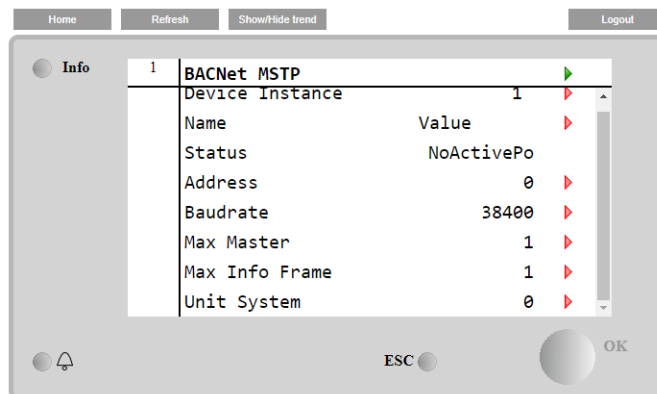

To establish the connection, the RS485 port to use is the one on the T14 terminal of the MT4 controller.

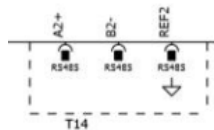

4.23 BACnet IP

When the software option "BACnet IP" is activated and the controller is restarted, the communication protocol settings page can be accessed via the path:

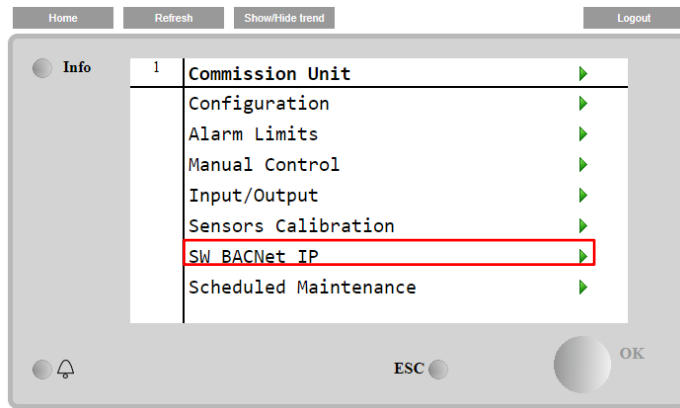

Main Menu→Commission Unit→SW BACNet IP

The values that can be set are the same as those found on the BACNet IP option page with the relative driver and depend on the specific system where the unit is installed.

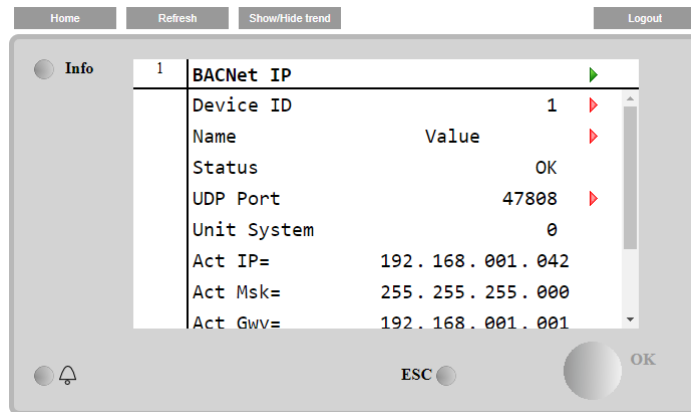

The port for LAN connection to be used for BACNet IP communication is the T-IP Ethernet port, the same one used for remote control of the controller on the PC.

4.24 Energy Monitoring

The Energy Monitoring is a software option not requiring any additional hardware. It can be activated to achieve an estimation (5% accuracy) of the instantaneous performances of the chiller in terms of:

- Cooling Capacity
- Power Input
- Efficiency-COP

An integrated estimation of these quantities is provided. Go to the page:

Main Menu→View / Set Unit→Energy Monitoring

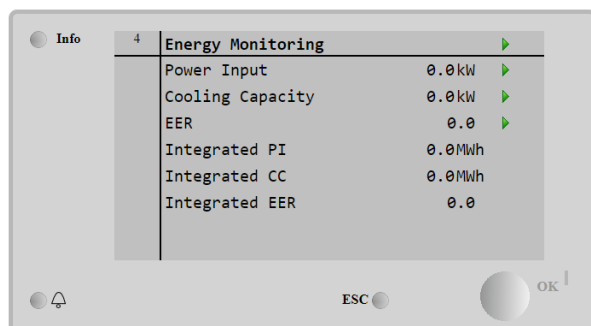
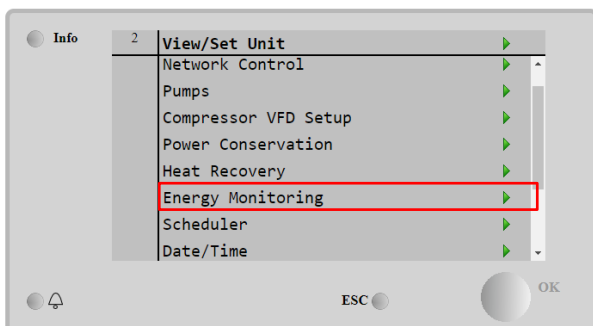

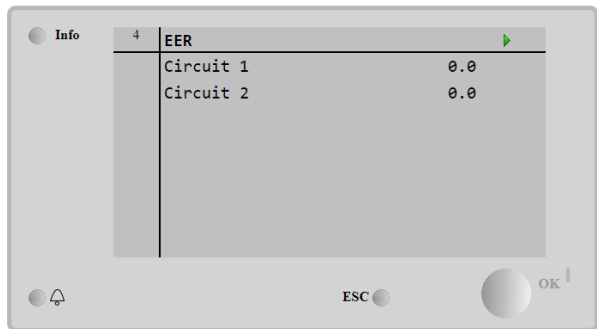
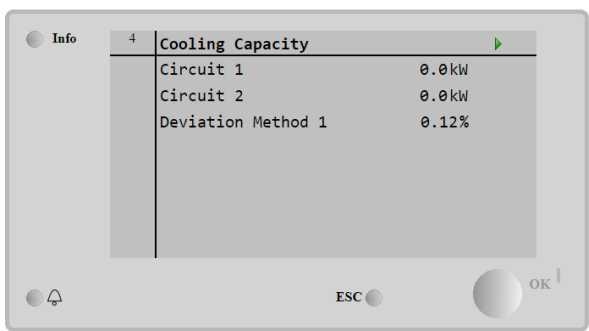
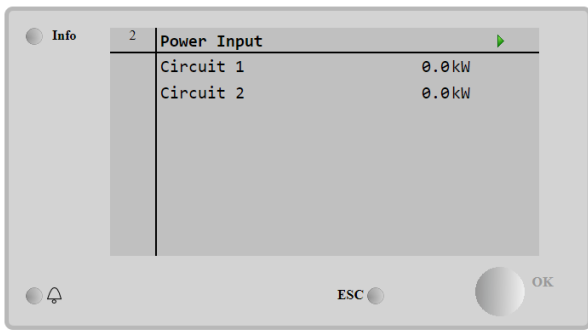

5 ALARMS AND TROUBLESHOOTING

The UC protects the unit and the components from operating in abnormal conditions. Protections can be divided in preventions and alarms. Alarms can then be divided in pump-down and rapid stop alarms. Pump-down alarms are activated when the system or sub-system can perform a normal shutdown despite the abnormal running conditions. Rapid stop alarms are activated when the abnormal running conditions require an immediate stop of the whole system or sub-system to prevent potential damages.

The UC displays the active alarms in a dedicated page and keep an history of the last 50 entries divided between alarms and acknowledges occurred. Time and date for each alarm event and of each alarm acknowledge are stored.

The UC also stores alarm snapshot of each alarm occurred. Each item contains a snapshot of the running conditions right before the alarm has occurred. Different sets of snapshots are programmed corresponding to unit alarms and circuit alarms holding different information to help the failure diagnosis.

In the following sections it will also be indicated how each alarm can be cleared between local HMI, Network (by any of the high-level interfaces Modbus, Bacnet or Lon) or if the specific alarm will clear automatically. The following symbols are used:

<input checked="" type="checkbox"/>	Allowed
<input checked="" type="checkbox"/>	Not allowed
<input type="checkbox"/>	Not foreseen

5.1 Unit Alerts

5.1.1 Bad Current Limit Input

This alarm is generated when the Flexible Current Limit option has been enabled and the input to the controller is out of the admitted range.

Symptom	Cause	Solution
Unit status is Run. Bell icon is moving on controller's display. Flexible Current Limit function cannot be used. String in the alarm list: BadCurrentLimitInput String in the alarm log: ± BadCurrentLimitInput String in the alarm snapshot BadCurrentLimitInput	Flexible current limit input out of range. For this warning out of range is a signal less than 3mA or more than 21mA.	Check for values of input signal to the unit controller. It has to be in the allowed mA range.
		Check for electrical shielding of wirings.
		Check for right value of the unit's controller output in case input signal is into allowed range.
Reset		Notes
Local HMI Network Auto	<input type="checkbox"/> <input type="checkbox"/> <input checked="" type="checkbox"/>	Automatically clears when the signal returns in the allowed range.

5.1.2 Option1BoardCommFail – Optional board 1 communication fail

This alarm is generated in case of communication problems with the AC module.

Symptom	Cause	Solution
Unit status is Off. All circuits are stopped immediately. Bell icon is moving on controller's display. String in the alarm list: Option1BoardCommFail String in the alarm log: ± Option1BoardCommFail String in the alarm snapshot Option1BoardCommFail	Module has no power supply	Check the power supply from the connector on the side of the module. Check if LEDs are both green. Check if the connector on the side is tightly inserted in the module
	Led Off	Check if power supply is ok but LEDs are both off. In this case replace the module
	BUS or BSP Led are red	Check if module's address is correct referring to the wiring diagram. If BSP LED is solid red replace the module.
		BSP error.
Reset		
Local HMI Network Auto	<input checked="" type="checkbox"/> <input checked="" type="checkbox"/> <input type="checkbox"/>	

5.1.3 Bad Leaving Water Temperature Reset Input

This alarm is generated when the Setpoint Reset option has been enabled and the input to the controller is out of the admitted range.

Symptom	Cause	Solution
Unit status is Run. Bell icon is moving on controller's display. LWT Reset function cannot be used. String in the alarm list: BadSetPtOverrideInput String in the alarm log: ± BadSetPtOverrideInput String in the alarm snapshot BadSetPtOverrideInput	LWT reset input signal is out of range. For this warning out of range is a signal less than 3mA or more than 21mA.	Check for values of input signal to the unit controller. It has to be in the allowed mA range.
		Check for electrical shielding of wirings.
		Check for right value of the unit's controller output in case input signal is into allowed range.
Reset		Notes
Local HMI Network Auto	<input type="checkbox"/> <input type="checkbox"/> <input checked="" type="checkbox"/>	Automatically clears when the signal returns in the allowed range.

5.1.4 Energy Meter Communication Fail

This alarm is generated in case of communication problems with the energy meter.

Symptom	Cause	Solution
Bell icon is moving on controller's display. String in the alarm list: EnrgMtrCommFail String in the alarm log: ± EnrgMtrCommFail String in the alarm snapshot EnrgMtrCommFail	Module has no power supply	Refer to the datasheet of the specific component to see if it is correctly powered
	Wrong cabling with the Unit Controller	Check if the polarity of the connections is respected.
	Modbus parameters not properly set	Referring to the datasheet of the specific component to see if the modbus parameters are set correctly: Address = 20 Baud Rate =19200 kBs Parity = None Stop bits =1
	Module is broken	Check if the display shows something and the power supply is present.
Reset		Notes
Local HMI Network Auto	<input type="checkbox"/> <input type="checkbox"/> <input checked="" type="checkbox"/>	Automatically clears when the communication is re-established.

5.1.5 Evaporator Pump #1 Failure

This alarm is generated if the pump is started but the flow switch is not able to close within the recirculate time. This can be a temporary condition or may be due to a broken flow switch, the activation of circuit breakers, fuses or to a pump breakdown.

Symptom	Cause	Solution
Unit could be ON. Bell icon is moving on controller's display. Backup pump is used or stop of all circuits in case of pump #2 failure. String in the alarm list: EvapPump1Fault String in the alarm log: ± EvapPump1Fault String in the alarm snapshot EvapPump1Fault	Pump #1 may not be operating.	Check for problem in electrical wiring of the pump #1.
		Check that electrical breaker of pump #1 is tripped.
		If fuses are used to protect the pump, check the integrity of fuses.
		Check for problem in wiring connection between pump starter and unit controller.
	Check the water pump filter and the water circuit for obstructions.	
	Flow Switch doesn't operate properly	Check flow switch connection and calibration.
Reset		Notes
Local HMI Network Auto	<input checked="" type="checkbox"/> <input checked="" type="checkbox"/> <input type="checkbox"/>	

5.1.6 Evaporator Pump #2 Failure

This alarm is generated if the pump is started but the flow switch is not able to close within the recirculate time. This can be a temporary condition or may be due to a broken flowswitch, the activation of circuit breakers, fuses or to a pump breakdown.

Symptom	Cause	Solution
Unit could be ON. Bell icon is moving on controller's display. Backup pump is used or stop of all circuits in case of pump #1 failure. String in the alarm list: EvapPump2Fault String in the alarm log: ± EvapPump2Fault String in the alarm snapshot EvapPump2Fault	Pump #2 may not be operating.	Check for problem in electrical wiring of the pump #2.
		Check that electrical breaker of pump #2 is tripped.
		If fuses are used to protect the pump, check the integrity of fuses.
		Check for problem in wiring connection between pump starter and unit controller.
		Flow Switch doesn't operate properly
Reset		Notes
Local HMI Network Auto	<input checked="" type="checkbox"/> <input checked="" type="checkbox"/> <input type="checkbox"/>	

5.1.7 External Event

This alarm indicates that a device, whose operation is linked with this machine, is reporting a problem on the dedicated input.

Symptom	Cause	Solution
Unit status is Run. Bell icon is moving on controller's display. String in the alarm list: UnitExternalEvent String in the alarm log: ±UnitExternalEvent String in the alarm snapshot UnitExternalEvent	There is an external event that has caused the opening, for at least 5 seconds of the digital input on the controller board.	Check for reasons of external event and if it can be a potential problem for a correct chiller operation.
Reset		Notes
Local HMI Network Auto	<input type="checkbox"/> <input type="checkbox"/> <input checked="" type="checkbox"/>	The alarm is automatically cleared when the problem is solved.
NOTE: What above applies in case of configuration of the external fault digital input as Event		

5.1.8 Password Over Time

Symptom	Cause	Solution
Pass1TimeOver 1dayleft	Temporary Password Inserted is going to expire. One day is left before Option set becomes inactive.	Insert a new password
Pass2TimeOver 1dayleft		
Pass3TimeOver 1dayleft		
Reset		Notes
Local HMI	<input checked="" type="checkbox"/>	
Network	<input checked="" type="checkbox"/>	
Auto	<input checked="" type="checkbox"/>	

5.1.9 Heat Recovery Entering Water Temperature sensor fault

This alarm is generated any time that the input resistance is out of an acceptable range.

Symptom	Cause	Solution
Unit status is Off. All circuits are stopped with a normal shutdown procedure. Bell icon is moving on controller's display. String in the alarm list: UnitAlHREwtSen String in the alarm log: ± UnitAlHREwtSen String in the alarm snapshot UnitAlHREwtSen	Sensor is broken.	Check for sensor integrity according to table and allowed kOhm (kΩ) range. Check correct sensors operation
	Sensor is shorted.	Check if sensor is shorted with a resistance measurement.
	Sensor is not properly connected (open).	Check for absence of water or humidity on electrical contacts.
		Check for correct plug-in of the electrical connectors. Check for correct sensors wiring also according electrical scheme.
Reset		Notes
Local HMI	<input checked="" type="checkbox"/>	
Network	<input checked="" type="checkbox"/>	
Auto	<input type="checkbox"/>	

5.1.10 Heat Recovery Leaving Water Temperature sensor fault

This alarm is generated any time that the input resistance is out of an acceptable range.

Symptom	Cause	Solution
Heat Recovery is Off Bell icon is moving on controller's display. String in the alarm list: UnitAlHRLwtSen String in the alarm log: ± UnitAlHRLwtSen String in the alarm snapshot UnitAlHRLwtSen	Sensor is broken.	Check for sensor integrity according to table and allowed kOhm (kΩ) range. Check correct sensors operation
	Sensor is shorted.	Check if sensor is shorted with a resistance measurement.
	Sensor is not properly connected (open).	Check for absence of water or humidity on electrical contacts.
		Check for correct plug-in of the electrical connectors. Check for correct sensors wiring also according to electrical scheme.
Reset		Notes
Local HMI	<input checked="" type="checkbox"/>	
Network	<input checked="" type="checkbox"/>	
Auto	<input type="checkbox"/>	

5.1.11 Heat Recovery Water Temperatures inverted

This alarm is generated any time that the heat recovery entering water temperature is lower than the leaving by 1°C and at least one compressor is running.

Symptom	Cause	Solution
Bell icon is moving on controller's display. Bell icon is moving on controller's display. String in the alarm list: Unit HRInVA1 String in the alarm log: ± Unit HRInVA1 String in the alarm snapshot Unit HRInVA1	Entering and leaving water temperature sensors are inverted.	Check cabling of the sensors on the unit controller. Check offset of the two sensors with the water pump running
	Entering and leaving water pipes are reversed	Check if the water flows in counter flow respect to refrigerant.
	Water pumps operate reverse.	Check if the water flows in counter flow respect to refrigerant.
Reset		Notes
Local HMI Network Auto	<input checked="" type="checkbox"/> <input checked="" type="checkbox"/> <input type="checkbox"/>	

5.1.12 Evaporator differential pressure transducer sensor fault

This alarm is generated any time the differential pressure transducer on the evaporator is broken.

Symptom	Cause	Solution
Unit status is On Bell icon is moving on controller's display. String in the alarm list: EvapPDSen String in the alarm log: ± EvapPDSen String in the alarm snapshot EvapPDSen	Sensor is broken.	Check for sensor integrity according to table and allowed Volts or Amps range. Check correct sensors operation
	Sensor is shorted.	Check if sensor is shorted with a resistance measurement.
	Sensor is not properly connected (open).	Check for absence of water or humidity on electrical contacts. Check for correct plug-in of the electrical connectors. Check for correct sensors wiring also according to electrical scheme.
Reset		Notes
Local HMI Network Auto	<input checked="" type="checkbox"/> <input checked="" type="checkbox"/> <input type="checkbox"/>	

5.1.13 System load differential pressure transducer sensor fault

This alarm is generated any time the differential pressure transducer on the evaporator is broken.

Symptom	Cause	Solution
Unit status is On Bell icon is moving on controller's display. String in the alarm list: LoadPDSen String in the alarm log: ± LoadPDSen String in the alarm snapshot LoadPDSen	Sensor is broken.	Check for sensor integrity according to table and allowed Volts or Amps range. Check correct sensors operation
	Sensor is shorted.	Check if sensor is shorted with a resistance measurement.
	Sensor is not properly connected (open).	Check for absence of water or humidity on electrical contacts. Check for correct plug-in of the electrical connectors. Check for correct sensors wiring also according to electrical scheme.
Reset		Notes
Local HMI Network Auto	<input checked="" type="checkbox"/> <input checked="" type="checkbox"/> <input type="checkbox"/>	

5.1.14 Switch Box Temperature High

This alarm is generated any time the switch box internal temperature exceeds a predetermined limit.

Symptom	Cause	Solution
Unit status is On Bell icon is moving on controller's display. String in the alarm list: Swit chBoxTA1m String in the alarm log: ± Swit chBoxTA1m String in the alarm snapshot Swit chBoxTA1m	Insufficient switchbox cooling	Check if the cooling fan is working properly Check if the air filters are clean and there is no obstacle to a proper air flow.
	Outside air temperature above the operating envelope of the unit.	Please refer to the operating envelope of the unit to avoid possible faults or damages to the unit.
Reset		Notes
Local HMI Network Auto	<input checked="" type="checkbox"/> <input checked="" type="checkbox"/> <input type="checkbox"/>	

5.1.15 Switch Box Temperature sensor fault

This alarm is generated any time that the input resistance is out of an acceptable range.

Symptom	Cause	Solution
Unit status is On Bell icon is moving on controller's display. Bell icon is moving on controller's display. String in the alarm list: Swit chBoxTSen String in the alarm log: ± Swit chBoxTSen String in the alarm snapshot Swit chBoxTSen	Sensor is broken.	Check for sensor integrity according to table and allowed kOhm (kΩ) range. Check correct sensors operation
	Sensor is shorted.	Check if sensor is shorted with a resistance measurement.
	Sensor is not properly connected (open).	Check for absence of water or humidity on electrical contacts. Check for correct plug-in of the electrical connectors.
		Check for correct sensors wiring also according to electrical scheme.
Reset		Notes
Local HMI Network Auto	<input checked="" type="checkbox"/> <input checked="" type="checkbox"/> <input type="checkbox"/>	

5.1.16 Glycol leaving water temperature sensor fault

This alarm is generated any time that the input resistance is out of an acceptable range.

Symptom	Cause	Solution
Unit status is On Bell icon is moving on controller's display. Bell icon is moving on controller's display. String in the alarm list: Unit Glyco1LvGWTemp String in the alarm log: ± Unit Glyco1LvGWTemp String in the alarm snapshot Unit Glyco1LvGWTemp	Sensor is broken.	Check for sensor integrity according to table and allowed kOhm (kΩ) range. Check correct sensors operation
	Sensor is shorted.	Check if sensor is shorted with a resistance measurement.
	Sensor is not properly connected (open).	Check for absence of water or humidity on electrical contacts. Check for correct plug-in of the electrical connectors.
		Check for correct sensors wiring also according to electrical scheme.
Reset		Notes
Local HMI Network Auto	<input type="checkbox"/> <input type="checkbox"/> <input checked="" type="checkbox"/>	Automatically clears when the communication is re-established.

5.1.17 Glycol entering water temperature sensor fault

This alarm is generated any time that the input resistance is out of an acceptable range.

Symptom	Cause	Solution
Unit status is On Bell icon is moving on controller's display. Bell icon is moving on controller's display. String in the alarm list:	Sensor is broken.	Check for sensor integrity according to table and allowed kOhm (kΩ) range. Check correct sensors operation
	Sensor is shorted.	Check if sensor is shorted with a resistance measurement.

Unit GlycolEntwTemp String in the alarm log: ± Unit GlycolEntwTemp String in the alarm snapshot Unit GlycolEntwTemp	Sensor is not properly connected (open).	Check for absence of water or humidity on electrical contacts. Check for correct plug-in of the electrical connectors. Check for correct sensors wiring also according to electrical scheme.
Reset		Notes
Local HMI Network Auto	<input type="checkbox"/> <input type="checkbox"/> <input checked="" type="checkbox"/>	Automatically clears when the communication is re-established.

5.1.18 Glycol module communication fail

This alarm is generated in case of communication problems with the module related to the glycol free.

Symptom	Cause	Solution
Unit is on. Bell icon is moving on controller's display. String in the alarm list: GlycolModuleCommFail String in the alarm log: ± GlycolModuleCommFail String in the alarm snapshot GlycolModuleCommFail	Module has no power supply	Check the power supply from the connector on the side of the module. Check if LEDs are both green. Check if the connector on the side is tightly inserted in the module
	Led Off	Check if power supply is ok but LEDs are both off. In this case replace the module
	BUS or BSP Led are red	Check if module's address is correct referring to the wiring diagram. If BSP LED is solid red replace the module. BSP error.
Reset		Notes
Local HMI Network Auto	<input type="checkbox"/> <input type="checkbox"/> <input checked="" type="checkbox"/>	Automatically clears when the communication is re-established.

5.1.19 Glycol pump communication fail

This alarm is generated in case of Modbus communication problems with glycol pump.

Symptom	Cause	Solution
Bell icon is moving on controller's display. String in the alarm list: GlycolPmpCommFail String in the alarm log: ± GlycolPmpCommFail String in the alarm snapshot GlycolPmpCommFail	RS485 network is not properly cabled.	Check the continuity of the RS485 network with the unit off. There should be continuity from the main controller to the pump as indicated on the wiring diagram.
	Modbus communication is not running properly.	Check glycol pump address. All the addresses must be different.
	Glycol pump is not powered	Check if the glycol pump is correctly powered.
Reset		Notes
Local HMI Network Auto	<input checked="" type="checkbox"/> <input checked="" type="checkbox"/> <input type="checkbox"/>	

5.1.20 Glycol pump alarm

This alarm is generated in case of generic hardware or operating problem with the glycol pump in the closed loop.

Symptom	Cause	Solution
Unit could be ON. Bell icon is moving on controller's display. String in the alarm list: GlycolPmpAlm String in the alarm log: ± GlycolPmpAlm String in the alarm snapshot GlycolPmpAlm	Glycol pump may not be operating.	Check for problem in electrical wiring of the glycol pump..
		Check that electrical breaker of glycol pump is tripped.
		If fuses are used to protect the glycol pump, check the integrity of fuses.
		Check the glycol pump filter and the glycol water circuit for obstructions.

Reset		Notes
Local HMI	<input checked="" type="checkbox"/>	
Network	<input checked="" type="checkbox"/>	
Auto	<input type="checkbox"/>	

5.1.21 Datacenter module temperature top PLC side sensor fault

This alarm is generated any time that the input resistance is out of an acceptable range.

Symptom	Cause	Solution
Unit status is On Bell icon is moving on controller's display. Bell icon is moving on controller's display. String in the alarm list: DCTtPLC Senf String in the alarm log: ± DCTtPLC Senf String in the alarm snapshot DCTtPLC Senf	Sensor is broken.	Check for sensor integrity according to table and allowed kOhm (kΩ) range. Check correct sensors operation
	Sensor is shorted.	Check if sensor is shorted with a resistance measurement.
	Sensor is not properly connected (open).	Check for absence of water or humidity on electrical contacts. Check for correct plug-in of the electrical connectors. Check for correct sensors wiring also according to electrical scheme.
Reset		Notes
Local HMI	<input type="checkbox"/>	Automatically clears when the communication is re-established.
Network	<input type="checkbox"/>	
Auto	<input checked="" type="checkbox"/>	

5.1.22 Datacenter module temperature bottom PLC side sensor fault

This alarm is generated any time that the input resistance is out of an acceptable range.

Symptom	Cause	Solution
Unit status is On Bell icon is moving on controller's display. Bell icon is moving on controller's display. String in the alarm list: DCTbPLC Senf String in the alarm log: ± DCTbPLC Senf String in the alarm snapshot DCTbPLC Senf	Sensor is broken.	Check for sensor integrity according to table and allowed kOhm (kΩ) range. Check correct sensors operation
	Sensor is shorted.	Check if sensor is shorted with a resistance measurement.
	Sensor is not properly connected (open).	Check for absence of water or humidity on electrical contacts. Check for correct plug-in of the electrical connectors. Check for correct sensors wiring also according to electrical scheme.
Reset		Notes
Local HMI	<input type="checkbox"/>	Automatically clears when the communication is re-established.
Network	<input type="checkbox"/>	
Auto	<input checked="" type="checkbox"/>	

5.1.23 Datacenter module temperature top 1 LH filter side sensor fault

This alarm is generated any time that the input resistance is out of an acceptable range.

Symptom	Cause	Solution
Unit status is On Bell icon is moving on controller's display. Bell icon is moving on controller's display. String in the alarm list: DCTt1AF Senf String in the alarm log: ± DCTt1AF Senf String in the alarm snapshot DCTt1AF Senf	Sensor is broken.	Check for sensor integrity according to table and allowed kOhm (kΩ) range. Check correct sensors operation
	Sensor is shorted.	Check if sensor is shorted with a resistance measurement.
	Sensor is not properly connected (open).	Check for absence of water or humidity on electrical contacts. Check for correct plug-in of the electrical connectors. Check for correct sensors wiring also according to electrical scheme.
Reset		Notes

Local HMI	<input type="checkbox"/>	Automatically clears when the communication is re-established.
Network	<input type="checkbox"/>	
Auto	<input checked="" type="checkbox"/>	

5.1.24 Datacenter module temperature top 2 LH filter side sensor fault

This alarm is generated any time that the input resistance is out of an acceptable range.

Symptom	Cause	Solution
Unit status is On Bell icon is moving on controller's display. Bell icon is moving on controller's display. String in the alarm list: DcTt2AF Senf String in the alarm log: ± DcTt2AF Senf String in the alarm snapshot DcTt1AF Senf	Sensor is broken.	Check for sensor integrity according to table and allowed kOhm (kΩ) range. Check correct sensors operation
	Sensor is shorted.	Check if sensor is shorted with a resistance measurement.
	Sensor is not properly connected (open).	Check for absence of water or humidity on electrical contacts. Check for correct plug-in of the electrical connectors. Check for correct sensors wiring also according to electrical scheme.
Reset		Notes
Local HMI	<input type="checkbox"/>	Automatically clears when the communication is re-established.
Network	<input type="checkbox"/>	
Auto	<input checked="" type="checkbox"/>	

5.1.25 Datacenter module temperature bottom LH filter side sensor fault

This alarm is generated any time that the input resistance is out of an acceptable range.

Symptom	Cause	Solution
Unit status is On Bell icon is moving on controller's display. Bell icon is moving on controller's display. String in the alarm list: DcTbAF Senf String in the alarm log: ± DcTbAF Senf String in the alarm snapshot DcTbAF Senf	Sensor is broken.	Check for sensor integrity according to table and allowed kOhm (kΩ) range. Check correct sensors operation
	Sensor is shorted.	Check if sensor is shorted with a resistance measurement.
	Sensor is not properly connected (open).	Check for absence of water or humidity on electrical contacts. Check for correct plug-in of the electrical connectors. Check for correct sensors wiring also according to electrical scheme.
Reset		Notes
Local HMI	<input type="checkbox"/>	Automatically clears when the communication is re-established.
Network	<input type="checkbox"/>	
Auto	<input checked="" type="checkbox"/>	

5.1.26 Datacenter module relative humidity sensor fault

This alarm is generated any time that the input resistance is out of an acceptable range.

Symptom	Cause	Solution
Unit status is On Bell icon is moving on controller's display. Bell icon is moving on controller's display. String in the alarm list: DcRelHum Senf String in the alarm log: ± DcRelHum Senf String in the alarm snapshot DcRelHum Senf	Sensor is broken.	Check for sensor integrity according to table and allowed mV range. Check correct sensors operation
	Sensor is shorted.	Check if sensor is shorted with a resistance measurement.
	Sensor is not properly connected (open).	Check for absence of water or humidity on electrical contacts. Check for correct plug-in of the electrical connectors. Check for correct sensors wiring also according to electrical scheme.
Reset		Notes
Local HMI	<input type="checkbox"/>	Automatically clears when the communication is re-established.
Network	<input type="checkbox"/>	
Auto	<input checked="" type="checkbox"/>	

5.1.27 Datacenter module communication fail

This alarm is generated in case of communication problems with the datacenter module.

Symptom	Cause	Solution
Unit status is On. Bell icon is moving on controller's display. String in the alarm list: DcModCommFail String in the alarm log: ± DcModCommFail String in the alarm snapshot DcModCommFail	Module has no power supply	Check the power supply from the connector on the side of the module. Check if LEDs are both green. Check if the connector on the side is tightly inserted in the module
	Led Off	Check if power supply is ok but LEDs are both off. In this case replace the module
	BUS or BSP Led are red	Check if module's address is correct referring to the wiring diagram. If BSP LED is solid red replace the module. BSP error.
Reset		Notes
Local HMI Network Auto	<input type="checkbox"/> <input type="checkbox"/> <input checked="" type="checkbox"/>	Automatically clears when the communication is re-established.

5.1.28 SAF communication fail

This alarm is generated in case of communication problems with the SAF.

Symptom	Cause	Solution
Bell icon is moving on controller's display. String in the alarm list: SAF CommErr String in the alarm log: ± SAF CommErr String in the alarm snapshot SAF CommErr	RS485 network is not properly cabled.	Check the continuity of the RS485 network with the unit off. There should be continuity from the main controller to the SAF as indicated on the wiring diagram.
	Modbus communication is not running properly.	SAF pump address. All the addresses must be different.
	SAF is not powered	Check if the SAF is correctly powered.
Reset		Notes
Local HMI Network Auto	<input type="checkbox"/> <input type="checkbox"/> <input checked="" type="checkbox"/>	Automatically clears when the communication is re-established.

5.1.29 SAF High current

This alarm indicates that the SAF current has exceeded a safety limit and it must be stopped to avoid damages to components.

Symptom	Cause	Solution
Bell icon is moving on controller's display. String in the alarm list: SAF HiCurrent String in the alarm log: ± SAF HiCurrent String in the alarm snapshot SAF HiCurrent	Filter adsorbed current is exceeding a predefined limit	Contact service organization to check filter integrity.
Reset		Notes
Local HMI Network Auto	<input type="checkbox"/> <input type="checkbox"/> <input checked="" type="checkbox"/>	

5.1.30 SAF High temperature

This alarm indicates that the SAF temperature has exceeded a safety limit and it must be stopped to avoid damages to components.

Symptom	Cause	Solution
Bell icon is moving on controller's display. String in the alarm list: SAF HiTemp String in the alarm log: ± SAF HiTemp String in the alarm snapshot SAF HiTemp	PTC is being used and its Ohm value has reached the safety threshold.	Check the motor and the PTC thermal probe.
Reset		Notes
Local HMI Network Auto	<input type="checkbox"/> <input type="checkbox"/> <input checked="" type="checkbox"/>	

5.1.31 SAF High regulation card temperature

This alarm indicates that the SAF regulation card temperature has exceeded a safety limit and it must be stopped to avoid damages to components.

Symptom	Cause	Solution
Bell icon is moving on controller's display. String in the alarm list: SAF HiRegTemp String in the alarm log: ± SAF HiRegTemp String in the alarm snapshot SAF HiRegTemp	Filter regulation card temperature is greater than maximum threshold	Contact service organization to check filter integrity.
Reset		Notes
Local HMI Network Auto	<input type="checkbox"/> <input type="checkbox"/> <input checked="" type="checkbox"/>	

5.1.32 SAF Under voltage

This alarm indicates that the SAF voltage supply has too low and it must be stopped to avoid damages to components.

Symptom	Cause	Solution
Bell icon is moving on controller's display. String in the alarm list: SAF UnderVtg String in the alarm log: ± SAF UnderVtg String in the alarm snapshot SAF UnderVtg	Filter is operating under unsafe condition and for this reason the inverter must be stopped.	Contact service organization to get the problem solved.
Reset		Notes
Local HMI Network Auto	<input type="checkbox"/> <input type="checkbox"/> <input checked="" type="checkbox"/>	

5.1.33 SAF Over voltage

This alarm indicates that the SAF voltage supply has too high and it must be stopped to avoid damages to components.

Symptom	Cause	Solution
Bell icon is moving on controller's display. String in the alarm list: SAF OverVtg String in the alarm log: ± SAF OverVtg String in the alarm snapshot SAF OverVtg	Filter is operating under unsafe condition and for this reason the inverter must be stopped.	Contact service organization to get the problem solved.
Reset		Notes

Local HMI	<input type="checkbox"/>	
Network	<input type="checkbox"/>	
Auto	<input checked="" type="checkbox"/>	

5.1.34 SAF Precharge Failure

This alarm indicates that the SAF precharge procedure failed.

Symptom	Cause	Solution
Bell icon is moving on controller's display. String in the alarm list: SAF PreChgFail String in the alarm log: ± SAF PreChgFail String in the alarm snapshot SAF PreChgFail	Filter has not been able to complete the precharging phase, before to start the running.	Contact service organization to get the problem solved.
Reset		Notes
Local HMI	<input type="checkbox"/>	
Network	<input type="checkbox"/>	
Auto	<input checked="" type="checkbox"/>	

5.1.35 SAF Precharge k1 Failure

This alarm indicates that the SAF contactor 1 precharge procedure failed.

Symptom	Cause	Solution
Bell icon is moving on controller's display. String in the alarm list: SAF K1PCFail String in the alarm log: ± SAF K1PCFail String in the alarm snapshot SAF K1PCFail	Filter has not been able to complete the precharging phase, before to start the running.	Contact service organization to get the problem solved.
Reset		Notes
Local HMI	<input type="checkbox"/>	
Network	<input type="checkbox"/>	
Auto	<input checked="" type="checkbox"/>	

5.1.36 SAF Precharge k2 Failure

This alarm indicates that the SAF contactor 2 precharge procedure failed.

Symptom	Cause	Solution
Bell icon is moving on controller's display. String in the alarm list: SAF K2PCFail String in the alarm log: ± SAF K2PCFail String in the alarm snapshot SAF K2PCFail	Filter has not been able to complete the precharging phase, before to start the running.	Contact service organization to get the problem solved.
Reset		Notes
Local HMI	<input type="checkbox"/>	
Network	<input type="checkbox"/>	
Auto	<input checked="" type="checkbox"/>	

5.1.37 SAF STO Fault

This alarm indicates that the SAF safe torque contact is off. STO contact is linked in series to the other VFDs.

Symptom	Cause	Solution
Bell icon is moving on controller's display. String in the alarm list: SAF STO Fault String in the alarm log:	Filter is operating under unsafe condition and for this reason the inverter must be stopped.	Contact service organization to get the problem solved.

± SAF STO Fault String in the alarm snapshot SAF STO Fault		
Reset		Notes
Local HMI Network Auto	<input type="checkbox"/> <input type="checkbox"/> <input checked="" type="checkbox"/>	

5.1.38 SAF STO Fault

This alarm indicates a generic alarm to the SAF (not the previously already mentioned).

Symptom	Cause	Solution
Bell icon is moving on controller's display. String in the alarm list: SAF Fault String in the alarm log: ± SAF Fault String in the alarm snapshot SAF Fault	Filter is operating under unsafe condition and for this reason the inverter must be stopped.	Contact service organization to get the problem solved.
Reset		Notes
Local HMI Network Auto	<input type="checkbox"/> <input type="checkbox"/> <input checked="" type="checkbox"/>	

5.2 Unit Pumpdown Stop Alarms

5.2.1 Evaporator Entering Water Temperature (EWT) sensor fault

This alarm is generated any time the input resistance is out of an acceptable range.

Symptom	Cause	Solution
Unit status is Off. All circuits are stopped with a normal shutdown procedure. Bell icon is moving on controller's display. String in the alarm list: UnitOffEvpEntWTempSen String in the alarm log: ± UnitOffEvpEntWTempSen String in the alarm snapshot UnitOffEvpEntWTempSen	Sensor is broken.	Check for sensor integrity according to table and allowed kOhm (kΩ) range. Check correct sensors operation
	Sensor is shorted.	Check if sensor is shorted with a resistance measurement.
	Sensor is not properly connected (open).	Check for absence of water or humidity on electrical contacts.
		Check for correct plug-in of the electrical connectors. Check for correct sensors wiring also according to electrical scheme.
Reset		Notes
Local HMI Network	<input checked="" type="checkbox"/> <input checked="" type="checkbox"/>	

5.2.2 Evaporator Water Temperatures inverted

This alarm is generated any time the entering water temperature is lower than the leaving by 1°C and at least one compressor is running for 90 seconds.

Symptom	Cause	Solution
Unit status is Off. All circuits are stopped with a normal shutdown procedure. Bell icon is moving on controller's display. String in the alarm list: UnitOffEvpwTempInvrtd String in the alarm log: ± UnitOffEvpwTempInvrtd String in the alarm snapshot UnitOffEvpwTempInvrtd	Entering and leaving water temperature sensors are inverted.	Check cabling of the sensors on the unit controller. Check offset of the two sensors with the water pump running
	Entering and leaving water pipes are reversed	Check if the water flows in counter flow respect to refrigerant.
	Water pumps operate reverse.	Check if the water flows in counter flow respect to refrigerant.
Reset		Notes

Local HMI	<input checked="" type="checkbox"/>	
Network	<input checked="" type="checkbox"/>	
Auto	<input type="checkbox"/>	

5.2.3 Outside Air Temperature (OAT) Lockout

This alarm prevents the unit to start if the outside air temperature is too low. Purpose is to prevent low pressure trips at startup. The limit depends on the fan regulation that is installed on the unit. By default, this value is set to 10°C.

Symptom	Cause	Solution
Unit Status is OAT Lockout. All circuits are stopped with a normal shutdown procedure. Bell icon is moving on controller's display. String in the alarm list: StartInhbtAmbTempLo String in the alarm log: ± StartInhbtAmbTempLo String in the alarm snapshot StartInhbtAmbTempLo	Outside ambient temperature is lower than value set into unit's controller.	Check the minimum outside ambient temperature value set into the unit's controller. Check if this value is in accordance with chiller application, therefore check about the proper application and utilization of the chiller.
	Improper operation of Outside Ambient Temperature sensor.	Check for proper operation of OAT sensor according to information about kOhm (kΩ) range related to temperature values.
Reset		Notes
Local HMI	<input type="checkbox"/>	It clears automatically with a 2.5°C of hysteresis.
Network	<input type="checkbox"/>	
Auto	<input checked="" type="checkbox"/>	

5.2.4 Outside Air Temperature sensor fault alarm

This alarm is generated any time the input resistance is out of an acceptable range.

Symptom	Cause	Solution
Unit status is Off. All circuits are stopped with a normal shutdown procedure. Bell icon is moving on controller's display. String in the alarm list: UnitOffAmbTempSen String in the alarm log: ± UnitOffAmbTempSen String in the alarm snapshot UnitOffAmbTempSen	Sensor is broken.	Check for sensor integrity. Check correct sensors operation according to table and allowed kOhm (kΩ) range.
	Sensor is shorted.	Check if sensor is shorted with a resistance measurement.
	Sensor is not properly connected (open).	Check for absence of water or humidity on electrical contacts. Check for correct plug-in of the electrical connectors. Check for correct sensors wiring also according to electrical scheme.
Reset		Notes
Local HMI	<input checked="" type="checkbox"/>	
Network	<input checked="" type="checkbox"/>	
Auto	<input type="checkbox"/>	

5.3 Unit Rapid Stop Alarms

5.3.1 Emergency Stop

This alarm is generated any time the Emergency Stop button is activated.



Before resetting the Emergency Stop button please verify that the harmful condition has been removed.

Symptom	Cause	Solution
Unit status is Off. All circuits are stopped immediately. Bell icon is moving on controller's display. String in the alarm list: UnitOffEmergencyStop String in the alarm log: ± UnitOffEmergencyStop String in the alarm snapshot UnitOffEmergencyStop	Emergency stop button has been pushed.	Turning counterclockwise the emergency stop button, the alarm should be cleared.

Reset		Notes
Local HMI	<input checked="" type="checkbox"/>	Please see note on the top.
Network	<input checked="" type="checkbox"/>	
Auto	<input type="checkbox"/>	

5.3.2 Evaporator Flow Loss alarm

This alarm is generated in case of flow loss to the chiller to protect the machine against freezing.

Symptom	Cause	Solution
Unit status is Off. All circuits are stopped immediately. Bell icon is moving on controller's display. String in the alarm list: UnitOffEvapWaterFlow String in the alarm log: ± UnitOffEvapWaterFlow String in the alarm snapshot UnitOffEvapWaterFlow	No water flow sensed for 3 minutes continuously or water flow too low.	Check the water pump filler and the water circuit for obstructions.
		Check the flow switch calibration and adapt to minimum water flow.
		Check if pump impeller can rotate freely and has no damages.
		Check pumps protection devices (circuit breakers, fuses, inverters, etc.)
		Check if water filter is clogged.
		Check flow switch connections.
Reset		Notes
Local HMI	<input checked="" type="checkbox"/>	
Network	<input checked="" type="checkbox"/>	
Auto	<input type="checkbox"/>	

5.3.3 Evaporator Leaving Water Temperature (LWT) sensor fault

This alarm is generated any time that the input resistance is out of an acceptable range.

Symptom	Cause	Solution
Unit status is Off. All circuits are stopped with a normal shutdown procedure. Bell icon is moving on controller's display. String in the alarm list: UnitOffLvgEntWTempSen String in the alarm log: ± UnitOffLvgEntWTempSen String in the alarm snapshot UnitOffEvplvgWTempSen	Sensor is broken.	Check for sensor integrity according to table and allowed kOhm (kΩ) range. Check correct sensors operation
	Sensor is shorted.	Check if sensor is shorted with a resistance measurement.
	Sensor is not properly connected (open).	Check for absence of water or humidity on electrical contacts.
		Check for correct plug-in of the electrical connectors. Check for correct sensors wiring also according to electrical scheme.
Reset		Notes
Local HMI	<input checked="" type="checkbox"/>	
Network	<input checked="" type="checkbox"/>	
Auto	<input type="checkbox"/>	

5.3.4 Evaporator Water Freeze alarm

This alarm is generated to indicate that the water temperature (entering or leaving) has dropped below a safety limit. Control tries to protect the heat exchanger starting the pump and letting the water circulate.

Symptom	Cause	Solution
Unit status is Off. All circuits are stopped immediately. Bell icon is moving on controller's display. String in the alarm list: UnitOffEvapWaterTmpLo String in the alarm log: ± UnitOffEvapWaterTmpLo String in the alarm snapshot UnitOffEvapWaterTmpLo	Water flow too low.	Increase the water flow.
	Inlet temperature to the evaporator is too low.	Increase the inlet water temperature.
	Flow switch is not working or no water flow.	Check the flow switch and the water pump.
	Sensor's readings (entering or leaving) are not properly calibrated.	Check the water temperatures with a proper instrument and adjust the offsets
	Wrong freeze limit setpoint.	The freeze limit has not been changed as a function of glycol percentage.
Reset		Notes

Local HMI	<input checked="" type="checkbox"/>	It's required to check if the evaporator has any damage due to this alarm.
Network	<input checked="" type="checkbox"/>	
Auto	<input type="checkbox"/>	

5.3.5 External alarm

This alarm is generated to indicate that an external device whose operation is linked with this unit operation. This external device could be a pump or an inverter.

Symptom	Cause	Solution
Unit status is Off. All circuits are switched off with the normal shutdown procedure. Bell icon is moving on controller's display. String in the alarm list: UnitOffExternalAlarm String in the alarm log: ± UnitOffExternalAlarm String in the alarm snapshot UnitOffExternalAlarm	There is an external event that has caused the opening, for at least 5 seconds of the port on the controller board.	Check causes of the external event or alarm.
		Check electrical wiring from unit controller to the external equipment in case of any external events or alarms have been occurred.
Reset		Notes
Local HMI	<input checked="" type="checkbox"/>	
Network	<input checked="" type="checkbox"/>	
Auto	<input type="checkbox"/>	
NOTE: What above applies in case of configuration of the external fault digital input as Alarm.		

5.3.6 UnitOff CC1CommFail - Circuit 1 – CC1 Communication Error

This alarm is generated in case of communication problems with the AC module.

Symptom	Cause	Solution
Unit status is Off. All circuits are stopped immediately. Bell icon is moving on controller's display. String in the alarm list: UnitOff CC1CommFail String in the alarm log: ± UnitOff CC1CommFail String in the alarm snapshot UnitOff CC1CommFail	Module has no power supply	Check the power supply from the connector on the side of the module. Check if LEDs are both green. Check if the connector on the side is tightly inserted in the module
	Led Off	Check if power supply is ok but LEDs are both off. In this case replace the module
	BUS or BSP Led are red	Check if module's address is correct referring to the wiring diagram. If BSP LED is solid red replace the module. BSP error.
Reset		
Local HMI	<input checked="" type="checkbox"/>	
Network	<input checked="" type="checkbox"/>	
Auto	<input type="checkbox"/>	

5.3.7 UnitOff CC2CommFail - Circuit 2 – CC2 Communication Error

This alarm is generated in case of communication problems with the AC module.

Symptom	Cause	Solution
Unit status is Off. All circuits are stopped immediately. Bell icon is moving on controller's display. String in the alarm list: UnitOff CC2CommFail String in the alarm log: ± UnitOff CC2CommFail String in the alarm snapshot	Module has no power supply	Check the power supply from the connector on the side of the module. Check if LEDs are both green. Check if the connector on the side is tightly inserted in the module
	Led Off	Check if power supply is ok but LEDs are both off. In this case replace the module
	BUS or BSP Led are red	Check if module's address is correct referring to the wiring diagram.

UnitOff CC2CommFail		If BSP LED is solid red replace the module. BSP error.
Reset		
Local HMI	<input checked="" type="checkbox"/>	
Network	<input checked="" type="checkbox"/>	
Auto	<input type="checkbox"/>	

5.3.8 UnitOff Module1C1CommFail - Circuit 1 – Module1C1 Communication Error

This alarm is generated in case of communication problems with the AC module.

Symptom	Cause	Solution
Unit status is Off. All circuits are stopped immediately. Bell icon is moving on controller's display. String in the alarm list: UnitOff Module1C1CommFail String in the alarm log: ± UnitOff Module1C1CommFail String in the alarm snapshot UnitOff Module1C1CommFail	Module has no power supply	Check the power supply from the connector on the side of the module. Check if LEDs are both green. Check if the connector on the side is tightly inserted in the module
	Led Off	Check if power supply is ok but LEDs are both off. In this case replace the module
	BUS or BSP Led are red	Check if module's address is correct referring to the wiring diagram. If BSP LED is solid red replace the module. BSP error.
Reset		
Local HMI	<input checked="" type="checkbox"/>	
Network	<input checked="" type="checkbox"/>	
Auto	<input type="checkbox"/>	

5.3.9 UnitOff Module1C2CommFail - Circuit 2 – Module1C2 Communication Error

This alarm is generated in case of communication problems with the AC module.

Symptom	Cause	Solution
Unit status is Off. All circuits are stopped immediately. Bell icon is moving on controller's display. String in the alarm list: UnitOff Module1C2CommFail String in the alarm log: ± UnitOff Module1C2CommFail String in the alarm snapshot UnitOff Module1C2CommFail	Module has no power supply	Check the power supply from the connector on the side of the module. Check if LEDs are both green. Check if the connector on the side is tightly inserted in the module
	Led Off	Check if power supply is ok but LEDs are both off. In this case replace the module
	BUS or BSP Led are red	Check if module's address is correct referring to the wiring diagram. If BSP LED is solid red replace the module. BSP error.
Reset		
Local HMI	<input checked="" type="checkbox"/>	
Network	<input checked="" type="checkbox"/>	
Auto	<input type="checkbox"/>	

5.3.10 Heat Recovery Water Freeze Protect alarm

This alarm is generated to indicate that the heat recovery water temperature (entering or leaving) has dropped below a safety limit. Control tries to protect the heat exchanger starting the pump and letting the water circulate.

Symptom	Cause	Solution
Unit status is Off. All circuits are stopped immediately.	Water flow too low.	Increase the water flow.

Bell icon is moving on controller's display. String in the alarm list: UnitOff HRFreeze String in the alarm log: ± UnitOff HRFreeze String in the alarm snapshot UnitOff HRFreeze	Inlet temperature to the heat recovery is too low.	Increase the inlet water temperature.
	Sensor's readings (entering or leaving) are not properly calibrated	Check the water temperatures with a proper instrument and adjust the offsets
Reset		Notes
Local HMI Network Auto	<input checked="" type="checkbox"/> <input checked="" type="checkbox"/>	

5.3.11 OptionCtrlrCommFail

This alarm is generated in case of communication problems with the AC module.

Symptom	Cause	Solution
Unit status is Off. All circuits are stopped immediately. Bell icon is moving on controller's display. String in the alarm list: OptionCtrlrCommFail String in the alarm log: ± OptionCtrlrCommFail String in the alarm snapshot OptionCtrlrCommFail	Module has no power supply	Check the power supply from the connector on the side of the module. Check if LEDs are both green. Check if the connector on the side is tightly inserted in the module
	Module address is not properly set	Check if module's address is correct referring to the wiring diagram.
	Module is broken	Check if LED are on and both green. If BSP LED is solid red replace the module Check if power supply is ok but LEDs are both off. In this case replace the module
Reset		Notes
Local HMI Network Auto	<input checked="" type="checkbox"/> <input checked="" type="checkbox"/> <input type="checkbox"/>	

5.3.12 Power Fault (only units with the UPS option)

This alarm is generated when the main power is Off and the unit controller is powered by the UPS.



Resolution of this fault requires a direct intervention on the power supply of this unit. Direct intervention on the power supply can cause electrocution, burns or even death. This action must be performed only by trained persons. In case of doubts contact your maintenance company.

Symptom	Cause	Solution
Unit status is Off. All circuits are stopped immediately. Bell icon is moving on controller's display. String in the alarm list: Power Fault String in the alarm log: ± Power Fault String in the alarm snapshot Power Fault	Loss of one phase.	Check voltage level on each of the phases.
	Not correct sequence connection of L1, L2, L3.	Check sequence of L1, L2, L3 connections according to indication on chiller's electrical scheme.
	Voltage level on the unit's panel is not in the allowed range (±10%).	Check that voltage level on each phase is into the allowed range that is indicated on the chiller label. Is important to check the voltage level on each phase not only with chiller not running, but mainly with chiller running from minimum capacity up to full load capacity. That's because voltage drop can occur from a certain unit cooling capacity level, or because of certain working condition (i.e. high values of OAT). In these cases, the issue can be related with the sizing of power cables.
	There is a short-circuit on the unit.	Check for correct electrical isolation condition of each unit's circuit with a Megger tester.
Reset		Notes

Local HMI	<input checked="" type="checkbox"/>	
Network	<input checked="" type="checkbox"/>	
Auto		

5.3.13 PVM alarm

This alarm is generated in case of problems with the power supply to the chiller.



Resolution of this fault requires a direct intervention on the power supply of this unit. Direct intervention on the power supply can cause electrocution, burns or even death. This action must be performed only by trained persons. In case of doubts contact your maintenance company.

Symptom	Cause	Solution
Unit status is Off. All circuits are stopped immediately. Bell icon is moving on controller's display. String in the alarm list: UnitOffPhaveVoltage String in the alarm log: ± UnitOffPhaveVoltage String in the alarm snapshot UnitOffPhaveVoltage	Loss of one phase.	Check voltage level on each of the phases.
	Not correct sequence connection of L1, L2,L3.	Check sequence of L1, L2, L3 connections according to indication on chiller's electrical scheme.
	Voltage level on the unit's panel is not in the allowed range (±10%).	Check that voltage level on each phase is into the allowed range that is indicated on the chiller label. Is important to check the voltage level on each phase not only with chiller not running, but mainly with chiller running from minimum capacity up to full load capacity. That's because voltage drop can occur from a certain unit cooling capacity level, or because of certain working condition (i.e. high values of OAT). In these cases the issue can be related with the sizing of power cables.
	There is a short-circuit on the unit.	Check for correct electrical isolation condition of each unit's circuit with a Megger tester.
Reset		Notes
Local HMI	<input type="checkbox"/>	
Network	<input type="checkbox"/>	
Auto	<input checked="" type="checkbox"/>	

5.3.14 Glycol Water Freeze alarm

This alarm is generated to indicate that the glycol water temperature (entering or leaving) has dropped below a safety limit. Control tries to protect the intermediate heat exchanger starting the glycol pump and letting the glycol water circulate.

Symptom	Cause	Solution
Unit status is Off. All circuits are stopped immediately. Bell icon is moving on controller's display. String in the alarm list: UnitOff GlycolFreeze String in the alarm log: ± UnitOff GlycolFreeze String in the alarm snapshot UnitOff GlycolFreeze	Glycol Water flow too low.	Increase the water flow. Check the glycol pump
	Inlet temperature to the evaporator is too low.	Increase the inlet water temperature.
	Sensor's readings (entering or leaving) are not properly calibrated.	Check the glycol water temperatures with a proper instrument and adjust the offsets
	Wrong freeze limit setpoint.	The glycol freeze limit has not been changed as a function of glycol percentage.
Reset		Notes
Local HMI	<input checked="" type="checkbox"/>	It's required to check if the intermediate heat exchanger has any damage due to this alarm.
Network	<input checked="" type="checkbox"/>	
Auto	<input type="checkbox"/>	

5.4 Circuit Alerts

5.4.1 Economizer Pressure Sensor fault

This alarm is generated to indicate that the sensor is not reading properly.

Symptom	Cause	Solution
Circuit status is On. Economizer is Off. Bell icon is moving on controller's display. String in the alarm list: Cx EcoPressSen String in the alarm log: ± Cx EcoPressSen String in the alarm snapshot Cx EcoPressSen	Sensor is broken.	Check for sensor integrity. Check correct sensors operation according to information about mVolt (mV) range related to pressure values in kPa.
	Sensor is shorted.	Check if sensor is shorted with a resistance measurement.
	Sensor is not properly connected (open).	Check for correct installation of the sensor on refrigerant circuit pipe. The transducer must be able to sense the pressure through the valve's needle.
		Check for absence of water or humidity on sensor electrical contacts.
Check for correct plug-in of the electrical connectors.		
Check for correct sensors wiring also according to electrical scheme.		
Reset		Notes
Local HMI Network Auto	<input checked="" type="checkbox"/> <input checked="" type="checkbox"/> <input type="checkbox"/>	

5.4.2 Economizer Temperature Sensor fault

This alarm is generated to indicate that the sensor is not reading properly.

Symptom	Cause	Solution
Circuit status is On. Economizer is Off. Bell icon is moving on controller's display. String in the alarm list: Cx EcoTempSen String in the alarm log: ± Cx EcoTempSen String in the alarm snapshot Cx EcoTempSen	Sensor is shorted.	Check for sensor integrity. Check correct sensors operation according to information about kOhm (kΩ) range related to temperature values.
	Sensor is broken.	Check if sensor is shorted with a resistance measurement.
	Sensor is not good connected (open).	Check for correct installation of the sensor on refrigerant circuit pipe.
		Check for absence of water or humidity on sensor electrical contacts.
Check for correct plug-in of the electrical connectors.		
Check for correct sensors wiring also according with electrical scheme.		
Reset		Notes
Local HMI Network Auto	<input checked="" type="checkbox"/> <input checked="" type="checkbox"/> <input type="checkbox"/>	

5.4.3 Failed Pumpdown

This alarm is generated to indicate that the circuit hadn't been able to remove all the refrigerant from the evaporator. It automatically clears as soon as the compressor stops just to be logged in the alarm history. It may not be recognized from BMS because the communication latency can give enough time for the reset. It may not even be seen on the local HMI.

Symptom	Cause	Solution
Circuit status is Off. No indications on the screen String in the alarm list: -- String in the alarm log: ± Cx Failed Pumpdown String in the alarm snapshot Cx Failed Pumpdown	EEXV is not closing completely, therefore there's "short-circuit" between high pressure side with low pressure side of the circuit.	Check for proper operation and full closing position of EEXV. Sight glass should not show refrigerant flow after the valve is closed. Check LED on the top of the valve, C LED should be solid green. If both LED are blinking alternately the valve motor is not properly connected.
	Evaporating pressure sensor is not working properly.	Check for proper operation of evaporating pressure sensor.
	Compressor on circuit is internally damaged with a mechanical problem for example on internal check-valve, or on internal spirals or vanes.	Check compressors on circuits.

Reset		Notes
Local HMI	<input type="checkbox"/>	
Network	<input type="checkbox"/>	
Auto	<input checked="" type="checkbox"/>	

5.4.4 Gas Leakage Sensor fault

This alarm is generated to indicate that the sensor is not reading properly.

Symptom	Cause	Solution
Circuit status is On. Bell icon is moving on controller's display. String in the alarm list: Cx GasLeakSen String in the alarm log: ± Cx GasLeakSen String in the alarm snapshot Cx GasLeakSen	Sensor is broken.	Check for sensor integrity. Check correct sensors operation according to information about mVolt (mV) range related to ppm values.
	Sensor is shorted.	Check if sensor is shorted with a resistance measurement.
	Sensor is not properly connected (open).	Check for correct installation of the sensor.
		Check for absence of water or humidity on sensor electrical contacts.
		Check for correct plug-in of the electrical connectors.
		Check for correct sensors wiring also according to electrical scheme.
Reset		Notes
Local HMI	<input checked="" type="checkbox"/>	
Network	<input checked="" type="checkbox"/>	
Auto	<input type="checkbox"/>	

5.4.5 CxCmp1 MaintCode01

This alarm indicates that a component in the inverter may require verification or even a replacement.

Symptom	Cause	Solution
Circuit status is On. The compressor keeps operating as normal. Bell icon is moving on controller's display. String in the alarm list: CxCmp1 MaintCode01 String in the alarm log: ± CxCmp1 MaintCode01 String in the alarm snapshot CxCmp1 MaintCode01	The inverter cooling valve in the inverter, may require a verification or a replacement.	Contact your service organization to get the problem solved.
Reset		Notes
Local HMI	<input checked="" type="checkbox"/>	
Network	<input checked="" type="checkbox"/>	
Auto	<input type="checkbox"/>	

5.4.6 CxCmp1 MaintCode02

This alarm indicates that a component in the inverter may require verification or even a replacement.

Symptom	Cause	Solution
Circuit status is On. The compressor keeps operating as normal. Bell icon is moving on controller's display. String in the alarm list: CxCmp1 MaintCode02 String in the alarm log: ± CxCmp1 MaintCode02 String in the alarm snapshot CxCmp1 MaintCode02	The capacitors in the inverter, may require a verification or a replacement.	Contact your service organization to get the problem solved.
Reset		Notes
Local HMI	<input checked="" type="checkbox"/>	
Network	<input checked="" type="checkbox"/>	
Auto	<input type="checkbox"/>	

5.4.7 Power Loss

This alarm indicates that a short under voltage on main power supply, that does not turn off the unit, has occurred.

Symptom	Cause	Solution
Circuit status is On. The controller brings the compressor to the minimum speed and then normal operation is recovered (default 1200rpm) Bell icon is moving on controller's display. String in the alarm list: Cx PwrLossRun String in the alarm log: ± Cx PwrLossRun String in the alarm snapshot Cx PwrLossRun	Chiller main power supply had a down peak which caused the trip.	Check if main power supply is within the acceptable tolerance for this chiller
Reset		Notes
Local HMI Network Auto	<input type="checkbox"/> <input type="checkbox"/> <input checked="" type="checkbox"/>	



Resolution of this fault requires a direct intervention on the power supply of this unit. Direct intervention on the power supply can cause electrocution, burns or even death. This action must be performed only by trained persons. In case of doubts contact your maintenance company.

5.4.8 Liquid Temperature sensor fault

This alarm is generated to indicate that the sensor is not reading properly.

Symptom	Cause	Solution
Circuit status is On. Bell icon is moving on controller's display. String in the alarm list: Cx LiquidTemperatureSen String in the alarm log: ± Cx LiquidTemperatureSen String in the alarm snapshot Cx LiquidTemperatureSen	Sensor is shorted.	Check for sensor integrity. Check correct sensors operation according to information about kOhm (kΩ) range related to temperature values.
	Sensor is broken.	Check if sensor is shorted with a resistance measurement.
	Sensor is not properly connected (open).	Check for correct installation of the sensor on refrigerant circuit pipe. Check for absence of water or humidity on sensor electrical contacts. Check for correct plug-in of the electrical connectors.
		Check for correct sensors wiring also according with electrical scheme.
Reset		Notes
Local HMI Network Auto	<input checked="" type="checkbox"/> <input checked="" type="checkbox"/> <input type="checkbox"/>	

5.4.9 Liquid Pressure sensor fault

This alarm is generated to indicate that the sensor is not reading properly.

Symptom	Cause	Solution
Circuit status is Off. Bell icon is moving on controller's display. String in the alarm list: Cx LiquidPressureSen String in the alarm log: ± Cx LiquidPressureSen String in the alarm snapshot Cx LiquidPressureSen	Sensor is shorted.	Check for sensor integrity. Check correct sensors operation according to information about mV range related to temperature values.
	Sensor is broken.	Check if sensor is shorted with a resistance measurement.
	Sensor is not properly connected (open).	Check for correct installation of the sensor on refrigerant circuit pipe.

		Check for absence of water or humidity on sensor electrical contacts.
		Check for correct plug-in of the electrical connectors.
		Check for correct sensors wiring also according with electrical scheme.
Reset		Notes
Local HMI	<input checked="" type="checkbox"/>	
Network	<input checked="" type="checkbox"/>	
Auto	<input type="checkbox"/>	

5.4.10 SpeedTrol Fan Communication Error

This event indicates a communication problem with the only vfd fan present in speedtrol configuration.

Symptom	Cause	Solution
Circuit status is On. Bell icon is moving on controller's display. String in the alarm list: Cx ST Fan Comm Fail String in the alarm log: ± Cx ST Fan Comm Fail String in the alarm snapshot Cx ST Fan Comm Fail	RS485 network is not properly cabled.	Check the continuity of the RS485 network with the unit off. There should be continuity from the main controller to the last fan as indicated on the wiring diagram.
	Modbus communication is not running properly.	Check fans addresses. All the addresses must be different.
	Fans are not powered	Check if the fans are correctly powered.
Reset		Notes
Local HMI	<input checked="" type="checkbox"/>	The alarm clears automatically when the communication is re-established.
Network	<input checked="" type="checkbox"/>	
Auto	<input checked="" type="checkbox"/>	

5.4.11 Cx Fans Communication Error

This event indicates a communication problem with some fans (but not all) of the circuit.

Symptom	Cause	Solution
Circuit status is On. Bell icon is moving on controller's display. String in the alarm list: Cx FanCommError String in the alarm log: ± Cx FanCommError String in the alarm snapshot Cx FanCommError	RS485 network is not properly cabled.	Check the continuity of the RS485 network with the unit off. There should be continuity from the main controller to the last fan as indicated on the wiring diagram.
	Modbus communication is not running properly.	Check fans addresses. All the addresses must be different.
	Fans are not powered	Check if the fans are correctly powered.
Reset		Notes
Local HMI	<input checked="" type="checkbox"/>	The alarm clears automatically when the communication is re-established.
Network	<input checked="" type="checkbox"/>	
Auto	<input checked="" type="checkbox"/>	

5.4.12 Cx Fan Error

This alarm indicates that some fans (but not all) of the circuit have problems.

Symptom	Cause	Solution
Circuit status is On. The compressor keeps operating as normal. Bell icon is moving on controller's display. String in the alarm list: Cx Fan Error String in the alarm log: ± Cx Fan Error String in the alarm snapshot Cx Fan Error	Some fans of the circuit has a problem	Try to clear the error by turning the power off and on again after some minutes.

Reset		Notes
Local HMI Network Auto	<input checked="" type="checkbox"/> <input checked="" type="checkbox"/> <input checked="" type="checkbox"/>	A service engineer can check the alarm message error provided by each fan VFD.

5.4.13 Cx Fan Over V

This alarm indicates that some fans (but not all) of the circuit have over voltage problems.

Symptom	Cause	Solution
Circuit status is On. The compressor keeps operating as normal. Bell icon is moving on controller's display. String in the alarm list: Cx Fan OverV String in the alarm log: ± Cx Fan OverV String in the alarm snapshot Cx Cx Fan OverV	Some fans of the circuit has a problem	Check if power supply is within the acceptable tolerance the fans Check if the fans have had a problem of lost rotor during the start.
Reset		Notes
Local HMI Network Auto	<input checked="" type="checkbox"/> <input checked="" type="checkbox"/> <input checked="" type="checkbox"/>	A service engineer can check the alarm message error provided by each fan VFD.

5.4.14 Cx Fan Under V

This alarm indicates that some fans (but not all) of the circuit have under voltage problems.

Symptom	Cause	Solution
Circuit status is On. The compressor keeps operating as normal. Bell icon is moving on controller's display. String in the alarm list: Cx Fan UnderV String in the alarm log: ± Cx Fan UnderV String in the alarm snapshot Cx Cx Fan UnderV	Some fans of the circuit has a problem	Check if power supply is within the acceptable tolerance the fans Check the correct cabling of the fans
Reset		Notes
Local HMI Network Auto	<input checked="" type="checkbox"/> <input checked="" type="checkbox"/> <input checked="" type="checkbox"/>	A service engineer can check the alarm message error provided by each fan VFD.

5.5 Circuit Pumpdown Stop Alarms

5.5.1 Discharge Temperature Sensor fault

This alarm is generated to indicate that the sensor is not reading properly.

Symptom	Cause	Solution
Circuit status is Off. The circuit is switched off with the normal shutdown procedure. Bell icon is moving on controller's display. String in the alarm list: CxComp1 OffDischTmpSen	Sensor is shorted.	Check for sensor integrity. Check correct sensors operation according to information about kOhm (kΩ) range related to temperature values.
	Sensor is broken.	Check if sensor is shorted with a resistance measurement.

String in the alarm log: ± CxCmp1 OffDischTmpSen String in the alarm snapshot CxCmp1 OffDischTmpSen	Sensor is not properly connected (open).	Check for correct installation of the sensor on refrigerant circuit pipe.
		Check for absence of water or humidity on sensor electrical contacts.
		Check for correct plug-in of the electrical connectors.
		Check for correct sensors wiring also according with electrical scheme.
Reset		Notes
Local HMI	<input checked="" type="checkbox"/>	
Network	<input checked="" type="checkbox"/>	
Auto	<input type="checkbox"/>	

5.5.2 Gas Leakage fault

This alarm indicates a gas leakage in the compressor box.

Symptom	Cause	Solution
Circuit status is Off. The circuit is switched off with the shutdown procedure performing a deep pumpdown of the circuit. Bell icon is moving on controller's display. String in the alarm list: Cx OffGasLeakage String in the alarm log: ± Cx OffGasLeakage String in the alarm snapshot Cx OffGasLeakage	Gas leakage in the compressors box (A/C units).	Switch off the unit and perform a gas leakage test.
	Gas Leakage in the plant room.	Check if there are leakage on the unit with a detector eventually starting suction fans to change the air in the room.
	Gas leakage sensor fault.	Put the sensor in open air and check that the alarm can be cleared. In case replace the sensor or disable the option before getting a new part.
Reset		Notes
Local HMI	<input checked="" type="checkbox"/>	
Network	<input checked="" type="checkbox"/>	
Auto	<input type="checkbox"/>	

5.5.3 High Compressor Vfd Temperature fault

This alarm is generated to indicate that the Vfd temperature is too high to allow the compressor to run.

Symptom	Cause	Solution
Circuit status is Off. The circuit is switched off with the normal shutdown procedure. Bell icon is moving on controller's display. String in the alarm list: CxCmp1 VfdOverTemp String in the alarm log: ± CxCmp1 VfdOverTemp String in the alarm snapshot CxCmp1 VfdOverTemp	Cooling solenoid valve is not operating properly.	Check electrical connection of the solenoid valve.
		Check refrigerant charge. Low refrigerant charge can cause overheating of the Vfd electronic.
		Check for obstructions in the pipe.
	Vfd Heater not properly connected.	Check if Vfd heater is switched off when the Vfd temperature increases.
		Check if the contactor that commands the Vfd heater can switch properly.
Reset		Notes
Local HMI	<input checked="" type="checkbox"/>	
Network	<input checked="" type="checkbox"/>	
Auto	<input type="checkbox"/>	

5.5.4 Low Compressor Vfd Temperature fault

This alarm is generated to indicate that the Vfd temperature is too low to allow the compressor to run safely.

Symptom	Cause	Solution
Circuit status is Off. The circuit is switched off with the normal shutdown procedure. Bell icon is moving on controller's display. String in the alarm list: CxCmp1 VfdLowTemp String in the alarm log:	Cooling solenoid valve is not operating properly. It's always open when compressor runs.	Check electrical connection of the solenoid valve.
		Check operation of the valve to see if it can close properly.
		Check operating cycles of the valve. It has a limited number of cycles.

± CxCmp1 VfdLowTemp String in the alarm snapshot CxCmp1 VfdLowTemp	Vfd heater is not working.	Check if the Vfd heater is powered.
		Check if the Vfd heater is commanded on when Vfd temperature is low.
Reset		Notes
Local HMI Network Auto	<input checked="" type="checkbox"/> <input checked="" type="checkbox"/> <input type="checkbox"/>	

5.5.5 Low Discharge Superheat fault

This alarm indicates that the unit has worked for too long with low discharge super heat.

Symptom	Cause	Solution
Circuit status is Off. The circuit is switched off with the shutdown procedure. Bell icon is moving on controller's display. String in the alarm list: CxCmp1 OffDishSHLo String in the alarm log: ± CxCmp1 OffDishSHLo String in the alarm snapshot CxCmp1 OffDishSHLo	EEXV is not working correctly. It's not opening enough or it's moving in the opposite direction.	Check if pump-down can be finished for pressure limit reached;
		Check expansion valve movements.
		Check connection to the valve driver on the wiring diagram.
		Measure the resistance of each winding, it must be different from 0 Ohm.
Reset		Notes
Local HMI Network Auto	<input checked="" type="checkbox"/> <input checked="" type="checkbox"/> <input checked="" type="checkbox"/>	

5.5.6 Oil Pressure Sensor fault

This alarm is generated to indicate that the sensor is not reading properly.

Symptom	Cause	Solution
Circuit status is Off. The circuit is switched off with the normal shutdown procedure. Bell icon is moving on controller's display. String in the alarm list: CxCmp1 OffOilFeedPSen String in the alarm log: ± CxCmp1 OffOilFeedPSen String in the alarm snapshot CxCmp1 OffOilFeedPSen	Sensor is broken.	Check for sensor integrity. Check correct sensors operation according to information about mVolt (mV) range related to pressure values in kPa.
	Sensor is shorted.	Check if sensor is shorted with a resistance measurement.
	Sensor is not properly connected (open).	Check for correct installation of the sensor on refrigerant circuit pipe. The transducer must be able to sense the pressure through the valve's needle.
		Check for absence of water or humidity on sensor electrical contacts.
	Check for correct plug-in of the electrical connectors.	
	Check for correct sensors wiring also according electrical scheme.	
Reset		Notes
Local HMI Network Auto	<input checked="" type="checkbox"/> <input checked="" type="checkbox"/> <input type="checkbox"/>	

5.5.7 Antichattering alarm

This alarm is generated to indicate a fail during the antichattering procedure.

Symptom	Cause	Solution
Circuit status is Off. The circuit is switched off with the normal shutdown procedure. Bell icon is moving on controller's display. String in the alarm list: CxOff AntiChattering AlmString in the alarm log: ± CxOff AntiChattering String in the alarm snapshot	The procedure of antichattering fail. Antichattering can't equalized the pressure between economizer and suction line in a 10 minutes.	Check for solenoid valves (suction and discharge) integrity.

Cxoff AntiChattering		
Reset		Notes
Local HMI	<input checked="" type="checkbox"/>	
Network	<input checked="" type="checkbox"/>	
Auto	<input type="checkbox"/>	

5.5.8 Suction Temperature Sensor fault

This alarm is generated to indicate that the sensor is not reading properly.

Symptom	Cause	Solution
Circuit status is Off. The circuit is switched off with the normal shutdown procedure. Bell icon is moving on controller's display. String in the alarm list: CxCmp1 OffSuctTempSen String in the alarm log: ± CxCmp1 OffSuctTempSen String in the alarm snapshot CxCmp1 OffSuctTempSen	Sensor is shorted.	Check for sensor integrity.
		Check correct sensors operation according to information about kOhm (kΩ) range related to temperature values.
	Sensor is broken.	Check if sensor is shorted with a resistance measurement.
	Sensor is not good connected (open).	Check for correct installation of the sensor on refrigerant circuit pipe.
		Check for absence of water or humidity on sensor electrical contacts.
		Check for correct plug-in of the electrical connectors.
	Check for correct sensors wiring also according with electrical scheme.	
Reset		Notes
Local HMI	<input checked="" type="checkbox"/>	
Network	<input checked="" type="checkbox"/>	
Auto	<input type="checkbox"/>	

5.6 Circuit Rapid Stop Alarms

5.6.1 Compressor VFD Fault

This alarm indicates an abnormal condition that forced the inverter to stop.

Symptom	Cause	Solution
Circuit status is Off. The compressor does not load anymore, circuit is immediately stopped. Bell icon is moving on controller's display. String in the alarm list: CxCmp1 OffvfdFault String in the alarm log: ± CxCmp1 OffvfdFault String in the alarm snapshot CxCmp1 OffvfdFault	Inverter is operating in an unsafe condition and for this reason the inverter must be stopped.	Check the alarm snapshot to identify the alarm code from the inverter. Contact your service organization to get the problem solved.
Reset		Notes
Local HMI	<input checked="" type="checkbox"/>	
Network	<input checked="" type="checkbox"/>	
Auto	<input type="checkbox"/>	

5.6.2 Compressor VFD OverTemp

This alarm indicates that the Inverter temperature has exceeded a safety limit and the inverter has to be stopped in order to avoid damages to components. This alarm is related mainly to operation outside the operating envelope of the VFD.

Symptom	Cause	Solution
Circuit status is Off. The circuit is stopped. Bell icon is moving on controller's display. String in the alarm list: CxCmp1 OffvfdOverTemp String in the alarm log:	Insufficient motor cooling	Check refrigerant charge.
		Check if operational envelope of the unit is respected.
		Check operation of the cooling solenoid valve

± CxCmp1 OffvfdOverTemp String in the alarm snapshot CxCmp1 OffvfdOverTemp		
Reset		Notes
Local HMI Network Auto	<input checked="" type="checkbox"/> <input checked="" type="checkbox"/> <input type="checkbox"/>	

5.6.3 Compressor VFD Temperature high

This alarm indicates that the Inverter temperature has exceeded a safety limit and the inverter has to be stopped in order to avoid damages to components.

Symptom	Cause	Solution
Circuit status is Off. The circuit is stopped. Bell icon is moving on controller's display. String in the alarm list: CxCmp1 OffvfdTempHi String in the alarm log: ± CxCmp1 OffvfdTempHi String in the alarm snapshot CxCmp1 OffvfdTempHi	Insufficient motor cooling	Check refrigerant charge.
		Check if operational envelope of the unit is respected.
	Motor temperature sensor could not operate properly.	Check operation of the cooling solenoid valve
		Check the readings of the motor temperature sensor and check the Ohmic value. A correct reading should be around hundreds of Ohm at ambient temperature.
		Check the electrical connection of the sensor with the electronic board.
Reset		Notes
Local HMI Network Auto	<input checked="" type="checkbox"/> <input checked="" type="checkbox"/> <input type="checkbox"/>	

5.6.4 Compressor VFD A3 alarm

This alarm indicates that the Inverter tripped for a critical alarm

Symptom	Cause	Solution
Circuit status is Off. The circuit is stopped. Bell icon is moving on controller's display. String in the alarm list: Cx OffA3VfdFault String in the alarm log: ± Cx OffA3VfdFault String in the alarm snapshot Cx OffA3VfdFault	A3 Alarm	Contact your Daikin Service reference
Reset		Notes
Local HMI Network Auto	<input checked="" type="checkbox"/> <input checked="" type="checkbox"/> <input type="checkbox"/>	

5.6.5 Condensing Pressure sensor fault

This alarm indicates that the condensing pressure transducer is not operating properly.

Symptom	Cause	Solution
Circuit status is Off. The circuit is stopped. Bell icon is moving on controller's display. String in the alarm list: CxCmp1 OffCndPressSen String in the alarm log: ± CxCmp1 OffCndPressSen String in the alarm snapshot CxCmp1 OffCndPressSen	Sensor is broken.	Check for sensor integrity. Check correct sensors operation according to information about mVolt (mV) range related to pressure values in kPa.
	Sensor is shorted.	Check if sensor is shorted with a resistance measurement.
	Sensor is not properly connected (open).	Check for correct installation of the sensor on refrigerant circuit pipe. The transducer must be able to sense the pressure through the valve's needle. Check for absence of water or humidity on sensor electrical contacts.

		Check for correct plug-in of the electrical connectors.
		Check for correct sensors wiring also according electrical scheme.
Reset		Notes
Local HMI Network Auto	<input checked="" type="checkbox"/> <input checked="" type="checkbox"/> <input type="checkbox"/>	

5.6.6 Evaporating Pressure sensor fault

This alarm indicates that the evaporating pressure transducer is not operating properly.

Symptom	Cause	Solution
Circuit status is Off. The circuit is stopped. Bell icon is moving on controller's display. String in the alarm list: CxComp1 EvapPressSen String in the alarm log: ± CxComp1 EvapPressSen String in the alarm snapshot CxComp1 EvapPressSen	Sensor is broken.	Check for sensor integrity. Check correct sensors operation according to information about mVolt (mV) range related to pressure values in kPa.
	Sensor is shorted.	Check if sensor is shorted with a resistance measurement.
	Sensor is not properly connected (open).	Check for correct installation of the sensor on refrigerant circuit pipe. The transducer must be able to sense the pressure through the valve's needle.
		Check for absence of water or humidity on sensor electrical contacts.
		Check for correct plug-in of the electrical connectors.
		Check for correct sensors wiring also according to electrical scheme.
Reset		Notes
Local HMI Network Auto	<input checked="" type="checkbox"/> <input checked="" type="checkbox"/> <input type="checkbox"/>	

5.6.7 EXV Driver Error (A/C units only)

This alarm indicates an abnormal condition of the EXV Driver.

Symptom	Cause	Solution
Circuit status is Off. Circuit is immediately stopped. Bell icon is moving on controller's display. String in the alarm list: Cx OffEXVDrvError String in the alarm log: ± Cx OffEXVDrvError String in the alarm snapshot Cx OffEXVDrvError	Hardware Error	Contact your service organization to get the problem solved.
Reset		Notes
Local HMI Network Auto	<input checked="" type="checkbox"/> <input checked="" type="checkbox"/> <input type="checkbox"/>	

5.6.8 Fail Start Low Pressure

This alarm indicates that at the compressor start the evaporating pressure or condensing pressure is below a minimum fixed limit at compressor start.

Symptom	Cause	Solution
Circuit status is Off. The circuit is stopped. Bell icon is moving on controller's display. String in the alarm list: Cx OffStartFailEvPrLo String in the alarm log: ± Cx OffStartFailEvPrLo	Ambient temperature is too low (A/C units)	Check the operating envelope for this machine.
	Circuit refrigerant charge is too low	Check refrigerant charge.
		Check for gas leakage with a sniffer.

String in the alarm snapshot Cx OffstartFailEvpPrLo		
Reset		Notes
Local HMI Network Auto	<input checked="" type="checkbox"/> <input checked="" type="checkbox"/> <input type="checkbox"/>	

5.6.9 Fan VFD Over Current

This alarm indicates that the Inverter current has exceeded a safety limit and the inverter must be stopped to avoid damages to components.

Symptom	Cause	Solution
Circuit status is Off. The circuit is stopped. Bell icon is moving on controller's display. String in the alarm list: CxComp1 OffVfdOverCurr String in the alarm log: ± CxComp1 OffVfdOverCurr String in the alarm snapshot CxComp1 OffVfdOverCurr	The ambient temperature is too high.	Check the unit selection to see if the unit can operate at full load. Check if all fans are operating properly and can keep the condensing pressure at the proper level. Clean condenser coils to allow a lower condensing pressure.
Reset		Notes
Local HMI Network Auto	<input checked="" type="checkbox"/> <input checked="" type="checkbox"/> <input type="checkbox"/>	

5.6.10 High Discharge Temperature Alarm

This alarm indicates that the temperature at the discharge port of the compressor exceeded a maximum limit which may cause damages to the mechanical parts of the compressor.



When this alarm occurs compressor's crankcase and discharge pipes may become very hot. Be careful when getting in contact with the compressor and discharge pipes in this condition.

Symptom	Cause	Solution
Circuit status is Off. The compressor does not load anymore or even unload, circuit is stopped. Bell icon is moving on controller's display. String in the alarm list: CxComp1 OffDischTmpHi String in the alarm log: ± CxComp1 OffDischTmpHi String in the alarm snapshot CxComp1 OffDischTmpHi	Liquid Injection solenoid valve is not operating properly. Liquid injection orifice is small.	Check the electrical connection between the controller and the liquid injection solenoid valve. Check if the solenoid coil operates properly Check if the digital output operates correctly. Check if when the liquid injection solenoid is activated the temperature can be controlled between the limits. Check that the liquid injection line is not obstructed by observing the discharge temperature when it is activated.
	Discharge temperature sensor could not operate properly.	Check for proper operation of the discharge temperature
Reset		Notes
Local HMI Network Auto	<input checked="" type="checkbox"/> <input checked="" type="checkbox"/> <input type="checkbox"/>	

5.6.11 High Motor Current Alarm

This alarm indicates that the compressor absorbed current is exceeding a predefined limit.

Symptom	Cause	Solution
Circuit status is Off. The compressor does not load anymore or even unload, circuit is stopped. Bell icon is moving on controller's display.	The ambient temperature is too high (A/C units)	Check the unit selection to see if the unit can operate at full load. Check if all fans are operating properly and are able to keep the condensing pressure at the proper level (A/C units).

String in the alarm list: CxComp1 OffMtrAmpsHi		Clean condenser coils to allow a lower condensing pressure (A/C units).
String in the alarm log: ± CxComp1 OffMtrAmpsHi	The wrong compressor model has been selected.	Check the compressor model for this unit.
String in the alarm snapshot CxComp1 OffMtrAmpsHi		
Reset		Notes
Local HMI	<input checked="" type="checkbox"/>	
Network	<input checked="" type="checkbox"/>	
Auto	<input type="checkbox"/>	

5.6.12 High Motor Temperature Alarm

This alarm indicates that the motor temperature has exceeded the maximum temperature limit for safe operations.

Symptom	Cause	Solution
Circuit status is Off. The compressor does not load anymore or even unload, circuit is stopped. Bell icon is moving on controller's display. String in the alarm list: CxComp1 OffMotorTempHi String in the alarm log: ± CxComp1 OffMotorTempHi String in the alarm snapshot CxComp1 OffMotorTempHi	Insufficient motor cooling.	Check refrigerant charge.
		Check if operational envelope of the unit is respected.
	Motor temperature sensor could not operate properly.	Check the readings of the motor temperature sensor and check the Ohmic value. A correct reading should be around hundreds of Ohm at ambient temperature.
		Check the electrical connection of the sensor with the electronic board.
Reset		Notes
Local HMI	<input checked="" type="checkbox"/>	
Network	<input checked="" type="checkbox"/>	
Auto	<input type="checkbox"/>	

5.6.13 High Oil Pressure Differential Alarm

This alarm indicates that the oil filter is clogged and needs to be replaced.

Symptom	Cause	Solution
Circuit status is Off. The circuit is stopped. Bell icon is moving on controller's display. String in the alarm list: CxComp1 OffOilPrDiffHi String in the alarm log: ± CxComp1 OffOilPrDiffHi String in the alarm snapshot CxComp1 OffOilPrDiffHi	Oil filter is clogged.	Replace oil filter.
	Oil Pressure Transducer is reading incorrectly.	Check Oil Pressure Transducer readings with a gauge.
	Condensing Pressure Transducer is reading incorrectly.	Check Condensing Pressure Transducer readings with a gauge.
Reset		Notes
Local HMI	<input checked="" type="checkbox"/>	
Network	<input checked="" type="checkbox"/>	
Auto	<input type="checkbox"/>	

5.6.14 High Pressure alarm

This alarm is generated in case the Condensing saturated temperature rise above the Maximum condensing saturated temperature and the control is not able to compensate to this condition. The maximum condenser saturated temperature is 68.5°C but it can decrease when the evaporator saturated temperature become negative.

In case of water-cooled chillers operating at high condenser water temperature, if the Condensing saturated temperature exceeds the Maximum condenser saturated temperature, the circuit is only switched off without any notification on the screen as this condition is considered acceptable in this range of operation.

Symptom	Cause	Solution
Circuit status is Off. The compressor does not load anymore or even unload, circuit is stopped. Bell icon is moving on controller's display. String in the alarm list: CxComp1 OffCndPressHi	One or more condenser fans do not operate properly (A/C units).	Check if fans protections have been activated.
		Check that the fans can turn freely.
		Check that there is not any obstacle to the free ejection of the air blown.
	Dirty or partially blocked condenser coil (A/C units).	Remove any obstacle; Clean the condenser coil using soft brush and blower.

String in the alarm log: ± CxCmp1 OffCndPressHi String in the alarm snapshot CxCmp1 OffCndPressHi	Inlet air temperature of the condenser is too high (A/C units).	The air temperature measured at the inlet of the condenser may not exceed the limit indicated in the operational range (working envelope) of the chiller. Check the location where the unit is installed and check that there are no short circuit of the hot-air blown from the fans of the same unit, or even from fans of next chillers (Check IOM for proper installation).
	One or more condenser fan turning in wrong direction (A/C units).	Check for correct phases sequence (L1, L2, L3) in the electrical connection of the fans.
	Excessive charge of refrigerant into the unit.	Check liquid sub-cooling and suction super-heat to control indirectly the correct charge of refrigerant. If necessary, recover all the refrigerant to weight the entire charge and to control if the value is in line with kg indication on unit label.
	Condensing pressure transducer could not operate properly.	Check for proper operation of the high-pressure sensor.
Reset		Notes
Local HMI Network Auto	<input checked="" type="checkbox"/> <input checked="" type="checkbox"/> <input type="checkbox"/>	

5.6.15 Low Pressure alarm

This alarm is generated in case the evaporating pressure drops below the Low Pressure Unload and the control is not able to compensate to this condition.

Symptom	Cause	Solution	
Circuit status is Off. The compressor does not load anymore or even unload, circuit is stopped immediately. Bell icon is moving on controller's display. String in the alarm list: CxCmp1 OffEvpPressLo String in the alarm log: ± CxCmp1 OffEvpPressLo String in the alarm snapshot CxCmp1 OffEvpPressLo	Transitory condition like a fan staging (A/C units).	Wait until the condition is recovered by EXV control	
	Refrigerant charge is low.	Check sight glass on liquid line to see if there is flash gas. Measure sub-cooling to see if the charge is correct.	
	Protection limits not set to fit customer application.	Check the evaporator approach and the corresponding water temperature to evaluate the low pressure hold limit.	
	High Evaporator Approach.	Clean the evaporator Check the quality of the fluid that flows into heat exchanger. Check the glycol percentage and type (ethilenic or propilenic)	
	Water flow into water heat exchanger is too low.	Increase the water flow. Check that evaporator water pump is operating correctly providing the required water flow.	
	Evaporating pressure transducer is not working properly.	Check the sensor for proper operation and calibrate the readings with a gauge.	
	EEXV is not working correctly. It's not opening enough or it's moving in the opposite direction.	Check if pump-down can be finished for pressure limit reached; Check expansion valve movements. Check connection to the valve driver on the wiring diagram. Measure the resistance of each winding, it has to be different from 0 Ohm.	
	Water temperature is low	Increase inlet water temperature. Check the low-pressure safeties settings.	
	Reset	A/C units	Notes

Local HMI	<input checked="" type="checkbox"/>		
Network	<input checked="" type="checkbox"/>		
Auto	<input type="checkbox"/>		

5.6.16 Low Pressure Ratio Alarm

This alarm indicates that the ratio between evaporating and condensing pressure is below a limit which depends on compressor speed and guarantees the proper lubrication to compressor.

Symptom	Cause	Solution
Circuit status is Off. The circuit is stopped. Bell icon is moving on controller's display. String in the alarm list: CxCmp1 OffPrRatioLo String in the alarm log: ± CxCmp1 OffPrRatioLo String in the alarm snapshot CxCmp1 OffPrRatioLo	Compressor is not able to develop the minimum compression.	Check fan setpoint and settings, it could be too low (A/C units).
		Check compressor absorbed current and discharge superheat. Compressor can be damaged.
		Check the correct operation of suction / delivery pressure sensors.
		Check the internal relief valve didn't open during previous operation (check the unit history). Note: If the difference between delivery and suction pressure exceeds 22bar, the internal relief valve open and need to be replaced.
		Inspect the gate rotors / screw rotor for possible damages.
Check if the cooling tower or three-way valves are operating correctly and properly set.		
Reset		Notes
Local HMI Network Auto	<input checked="" type="checkbox"/> <input checked="" type="checkbox"/> <input type="checkbox"/>	

5.6.17 Maximum Number of Restart Alarm

This alarm indicates that for three consecutive times after the compressor start the evaporating pressure is under a minimum limit for too much time

Symptom	Cause	Solution
Circuit status is Off. The circuit is stopped. Bell icon is moving on controller's display. String in the alarm list: Cx OffNbrRestarts String in the alarm log: ± Cx OffNbrRestarts String in the alarm snapshot Cx OffNbrRestarts	Ambient temperature is too low	Check the operating envelope for this machine.
Reset		Notes
Local HMI Network Auto	<input checked="" type="checkbox"/> <input checked="" type="checkbox"/> <input type="checkbox"/>	

5.6.18 Mechanical High Pressure Alarm

This alarm is generated when the condenser pressure rises above the mechanical high pressure limit causing this device to open the power supply to all the auxiliary relays. This causes an immediate shutdown of compressor and all the other actuators in this circuit.

Symptom	Cause	Solution
Circuit status is Off. The compressor does not load anymore or even unload, circuit is stopped. Bell icon is moving on controller's display. String in the alarm list: CxCmp1 OffMechPressHi	One or more condenser fans do not operate properly (A/C units).	Check if fans protections have been activated. Check that the fans can turn freely. Check that there is not any obstacle to the free ejection of the air blown.
	Dirty or partially blocked condenser coil (A/C units).	Remove any obstacle. Clean the condenser coil using soft brush and blower.

String in the alarm log: ± CxCmp1 OffMechPressHi String in the alarm snapshot CxCmp1 OffMechPressHi	Inlet air temperature of the condenser is too high (A/C units).	The air temperature measured at the inlet of the condenser may not exceed the limit indicated in the operational range (working envelope) of the chiller (A/C units). Check the location where the unit is installed and check that there are no short circuit of the hot-air blown from the fans of the same unit, or even from fans of next chillers (Check IOM for proper installation).
	One or more condenser fan turning in wrong direction.	Check for correct phases sequence (L1, L2, L3) in the electrical connection of the fans.
	Mechanical high-pressure switch is damaged or not calibrated.	Check for proper operation of the high-pressure switch.
Reset		Notes
Local HMI Network Auto	<input checked="" type="checkbox"/> <input checked="" type="checkbox"/> <input type="checkbox"/>	Reset of this alarm requires a manual action on the high-pressure switch.

5.6.19 No Pressure At Start Alarm

This alarm is used to indicate a condition where the pressure at the evaporator or at the condenser is lower than 35kPa, so the circuit is potentially empty of refrigerant.

Symptom	Cause	Solution
Circuit status is Off. The compressor does not start. Bell icon is moving on controller's display. String in the alarm list: Cx OffNoPressAtStart String in the alarm log: ± Cx OffNoPressAtStart String in the alarm snapshot Cx OffNoPressAtStart	Evaporator or condenser pressure are below 35kPa	Check transducers calibration with an appropriate gauge.
		Check transducers cabling and readout.
		Check refrigerant charge and set it to the proper value.
Reset		Notes
Local HMI Network Auto	<input checked="" type="checkbox"/> <input checked="" type="checkbox"/> <input type="checkbox"/>	

5.6.20 No Pressure Change At Start Alarm

This alarm indicates that the compressor is not able to start or to create a certain minimum variation of the evaporating or condensing pressures after start.

Symptom	Cause	Solution
Circuit status is Off. The circuit is stopped. Bell icon is moving on controller's display. String in the alarm list: Cx OffNoPressChgStart String in the alarm log: ± Cx OffNoPressChgStart String in the alarm snapshot Cx OffNoPressChgStart	Compressor cannot start	Check if the start signal is properly connected to the inverter.
	Compressor is turning in wrong direction.	Check correct phases sequence to the compressor (L1, L2, L3) according to the electrical scheme. Inverter is not properly programmed with the right direction of rotation
	Refrigerant circuit is empty of refrigerant.	Check circuit pressure and presence of refrigerant.
	Not proper operation of evaporating or condensing pressure transducers.	Check proper operation of evaporating or condensing pressure transducers.
Reset		Notes
Local HMI Network Auto	<input checked="" type="checkbox"/> <input checked="" type="checkbox"/> <input type="checkbox"/>	

5.6.21 Overvoltage Alarm on input voltage

This alarm indicates that chiller supply voltage exceeded the maximum limit which allows proper operations of the components. This is estimated looking at the DC voltage on the inverter which depends of course from the main power.



Resolution of this fault requires a direct intervention on the power supply of this unit.
Direct intervention on the power supply can cause electrocution, burns or even death. This action must be performed only by trained persons. In case of doubts contact your maintenance company.

Symptom	Cause	Solution
Circuit status is Off. The circuit is stopped. Bell icon is moving on controller's display. String in the alarm list: Cx OffOverVoltage-AC String in the alarm log: ± Cx OffOverVoltage-AC String in the alarm snapshot Cx OffOverVoltage-AC	Chiller main power supply had an up peak which caused the trip.	Check if main power supply is within the acceptable tolerance for this chiller
	Main power supply setting on the Microtech is not suitable with the power supply in use (A/C units).	Measure the power supply to the chiller and select the proper value on the Microtech HMI.
Reset		Notes
Local HMI Network Auto	<input checked="" type="checkbox"/> <input checked="" type="checkbox"/> <input checked="" type="checkbox"/>	The alarm clears automatically when the voltage is reduced to an acceptable limit.

5.6.22 Overvoltage Alarm on DC rectified voltage

This alarm indicates that chiller supply voltage exceeded the maximum limit which allows proper operations of the components. This is estimated looking at the DC voltage on the inverter which depends of course on the main power.



Resolution of this fault requires a direct intervention on the power supply of this unit.
Direct intervention on the power supply can cause electrocution, burns or even death. This action must be performed only by trained persons. In case of doubts contact your maintenance company.

Symptom	Cause	Solution
Circuit status is Off. The circuit is stopped. Bell icon is moving on controller's display. String in the alarm list: Cx OffOverVoltage-DC String in the alarm log: ± Cx OffOverVoltage-DC String in the alarm snapshot Cx OffOverVoltage-DC	Chiller main power supply had an up peak which caused the trip.	Check if main power supply is within the acceptable tolerance for this chiller
	Main power supply setting on the Microtech is not suitable with the power supply in use (A/C units).	Measure the power supply to the chiller and select the proper value on the Microtech HMI.
Reset		Notes
Local HMI Network Auto	<input checked="" type="checkbox"/> <input checked="" type="checkbox"/> <input checked="" type="checkbox"/>	The alarm clears automatically when the voltage is reduced to an acceptable limit.

5.6.23 Undervoltage Alarm on input voltage

This alarm indicates that chiller supply voltage exceeded the minimum limit which allows proper operations of the components.



Resolution of this fault requires a direct intervention on the power supply of this unit.
Direct intervention on the power supply can cause electrocution, burns or even death. This action must be performed only by trained persons. In case of doubts contact your maintenance company.

Symptom	Cause	Solution
Circuit status is Off. The circuit is stopped. Bell icon is moving on controller's display. String in the alarm list: Cx OffUnderVoltage-AC String in the alarm log: ± Cx OffUnderVoltage-AC String in the alarm snapshot Cx OffUnderVoltage-AC	Chiller main power supply had a down peak which caused the trip.	Check if main power supply is within the acceptable tolerance for this chiller
	Main power supply setting on the Microtech is not suitable with the power supply in use (A/C units).	Measure the power supply to the chiller and select the proper value on the Microtech HMI.
Reset		Notes
Local HMI Network Auto	<input checked="" type="checkbox"/> <input checked="" type="checkbox"/> <input checked="" type="checkbox"/>	The alarm clears automatically when the voltage is increased to an acceptable limit.

5.6.24 Undervoltage Alarm on DC rectified voltage

This alarm indicates that chiller supply voltage exceeded the minimum limit which allows proper operations of the components.



**Resolution of this fault requires a direct intervention on the power supply of this unit.
Direct intervention on the power supply can cause electrocution, burns or even death. This action must be performed only by trained persons. In case of doubts contact your maintenance company.**

Symptom	Cause	Solution
Circuit status is Off. The circuit is stopped. Bell icon is moving on controller's display. String in the alarm list: Cx OffUnderVoltage-DC String in the alarm log: ± Cx OffUnderVoltage-DC String in the alarm snapshot Cx OffUnderVoltage-DC	Chiller main power supply had a down peak which caused the trip.	Check if main power supply is within the acceptable tolerance for this chiller
	Main power supply setting on the Microtech is not suitable with the power supply in use (A/C units).	Measure the power supply to the chiller and select the proper value on the Microtech HMI.
Reset		Notes
Local HMI Network Auto	<input checked="" type="checkbox"/> <input checked="" type="checkbox"/> <input checked="" type="checkbox"/>	The alarm clears automatically when the voltage is increased to an acceptable limit.

5.6.25 VFD Communication Failure

This alarm indicates a communication problem with the inverter of the compressor.

Symptom	Cause	Solution
Circuit status is Off. The compressor does not load anymore, circuit is immediately stopped. Bell icon is moving on controller's display. String in the alarm list: CxComp1 OffVfdCommFail String in the alarm log: ± CxComp1 OffVfdCommFail String in the alarm snapshot CxComp1 OffVfdCommFail	RS485 network is not properly cabled.	Check the continuity of the RS485 network with the unit off. There should be continuity from the main controller to the last inverter as indicated on the wiring diagram.
	Modbus communication is not running properly.	Check inverter addresses and addresses of all the additional devices in the RS485 network (for example the energy meter). All the addresses must be different.
	Modbus interface card can be faulty	Check with your service organization to evaluate this possibility and eventually replace the board.
Reset		Notes
Local HMI Network Auto	<input checked="" type="checkbox"/> <input checked="" type="checkbox"/> <input checked="" type="checkbox"/>	The alarm clears automatically when the communication is re-established.

5.6.26 Fans Modbus Communication Failure

This alarm indicates a communication problem with all fans of the circuit.

Symptom	Cause	Solution
Circuit status is Off. The fans do not start, circuit is immediately stopped. Bell icon is moving on controller's display. String in the alarm list: Cx FanCommFail String in the alarm log: ± Cx FanCommFail String in the alarm snapshot Cx FanCommFail	RS485 network is not properly cabled.	Check the continuity of the RS485 network with the unit off. There should be continuity from the main controller to the last fan as indicated on the wiring diagram.
	Modbus communication is not running properly.	Check fans addresses. All the addresses must be different.
	Fans are not powered	Check if the fans are correctly powered.
Reset		Notes
Local HMI Network Auto	<input checked="" type="checkbox"/> <input checked="" type="checkbox"/> <input checked="" type="checkbox"/>	The alarm clears automatically when the communication is re-established.

5.6.27 Fan Fault

This alarm indicates that every fan of the circuit has a problem.

Symptom	Cause	Solution
Circuit status is On. The compressor keeps operating as normal. Bell icon is moving on controller's display. String in the alarm list: Cx FanAlm String in the alarm log: ± Cx FanAlm String in the alarm snapshot Cx FanAlm	Every fan of the circuit has a problem	Try to clear the error by turning the power off and on again after some minutes.
Reset		Notes
Local HMI Network Auto	<input checked="" type="checkbox"/> <input checked="" type="checkbox"/> <input checked="" type="checkbox"/>	A service engineer can check the alarm message error provided by each fan VFD.

The present publication is drawn up by of information only and does not constitute an offer binding upon Daikin Applied Europe S.p.A. Daikin Applied Europe S.p.A. has compiled the content of this publication to the best of its knowledge. No express or implied warranty is given for the completeness, accuracy, reliability, or fitness for particular purpose of its content, and the products and services presented therein. Specification is subject to change without prior notice. Refer to the data communicated at the time of the order. Daikin Applied Europe S.p.A. explicitly rejects any liability for any direct or indirect damage, in the broadest sense, arising from or related to the use and/or interpretation of this publication. All content is copyrighted by Daikin Applied Europe S.p.A.

DAIKIN APPLIED EUROPE S.p.A.

Via Piani di Santa Maria, 72 - 00072 Ariccia (Roma) - Italia

Tel: (+39) 06 93 73 11 - Fax: (+39) 06 93 74 014

<http://www.daikinapplied.eu>