

Public



REV	04
Date	10-2024
Supersedes	D-EOMAC01801-23_03EN

Operating Manual
D-EOMAC01801-23_04EN

Air Cooled chiller with scroll compressors

EWAT-B-C
EWFT-B-C
EWAT-M-C

TABLE OF CONTENTS

1	SAFETY CONSIDERATIONS	5
1.1	General	5
1.2	Before switching the unit	5
1.3	Avoid electrocution	5
2	GENERAL DESCRIPTION	6
2.1	Basic Information	6
2.2	Abbreviations used	6
2.3	Controller Operating Limits	6
2.4	Controller Architecture	6
2.5	Communication Modules	7
3	USING THE CONTROLLER	8
3.1	Navigating	8
3.2	Passwords	8
3.3	Editing	9
3.4	Mobile app HMI	9
3.5	Basic Control System Diagnostic	10
3.6	Controller maintenance	11
3.7	Optional Remote User Interface	11
3.8	Embedded Web Interface	12
4	WORKING WITH THIS UNIT	13
4.1	Chiller On/Off	13
4.1.1	Keypad On/Off	13
4.1.2	Scheduler and Silent mode functionalities	13
4.1.3	Network On/Off	14
4.2	Water Setpoints	14
4.3	Unit Mode	15
4.3.1	Heat/Cool Switch (Heat Pump Only)	16
4.3.2	Energy Saving mode	17
4.4	Unit Status	17
4.5	Network Control	18
4.6	Thermostatic Control	18
4.7	Date/Time	19
4.8	Pumps	20
4.9	External Alarm	20
4.10	Power Conservation	21
4.10.1	Demand Limit	21
4.10.2	Setpoint Reset	22
4.10.2.1	Setpoint Reset by OAT (A/C units only)	23
4.10.2.2	Setpoint Reset by External 4-20Ma signal	24
4.10.2.3	Setpoint Reset by DT	24
4.11	Electrical Data	25
4.12	Controller IP Setup	26
4.13	Daikin On Site	27
4.14	Heat Recovery	28
4.15	Rapid Restart	28
4.16	FreeCooling Hydronic (Cooling Only)	29
4.16.1	Glycol Free Freecooling	30
4.17	Antifreeze Heater	31
4.18	Glycol Tank Heater	31
4.19	Software Options	31
4.19.1	Changing the Password for buying new Software Options	32
4.19.2	Inserting the Password in a Spare Controller	32
4.19.3	Modbus MSTP Software Option	33
4.19.4	BACNET MSTP	34
4.19.5	BACNET IP	34
4.19.6	PERFORMANCE MONITORING	35
5	ALARMS AND TROUBLESHOOTING	37
5.1	Unit Alerts	37
5.1.1	BadLWTRReset - Bad Leaving Water Temperature Reset Input	37
5.1.2	EnergyMeterComm - Energy Meter Communication Fail	37
5.1.3	EvapPump1Fault - Evaporator Pump #1 Failure	37
5.1.4	BadDemandLimit - Bad Demand Limit Input	38
5.1.5	EvapPump2Fault - Evaporator Pump #2 Failure	38

5.1.6	SwitchBoxTHi - Switch box temperature High	38
5.1.7	SwitchBoxTSen - Switch Box Temperature sensor fault.....	39
5.1.8	ExternalEvent - External Event.....	39
5.1.9	HeatRec EntWTempSen - Heat Recovery Entering Water Temperature sensor fault.....	39
5.1.10	HeatRec LvgWTempSen - Heat Recovery Leaving Water Temperature sensor fault	40
5.1.11	HeatRec FreezeAlm - Heat Recovery Water Freeze Protect alarm.....	40
5.1.12	Option1BoardCommFail – Optional board 1 communication fail	40
5.1.13	UnitOff DLTModuleCommFail – DLT Module Communication Error.....	41
5.1.14	EvapPDSen – Evaporator Pressure Drop sensor fault	41
5.1.15	LoadPDSen – Load Pressure Drop sensor fault.....	41
5.1.16	Password x Over Time	42
5.1.17	Unit HRInvAI – Heat Recovery Water Temperature inverted.....	42
5.1.18	Glycol leaving water temperature sensor fault.....	42
5.1.19	Glycol entering water temperature sensor fault	42
5.1.20	Glycol module communication fail	43
5.1.21	Glycol pump communication fail	43
5.1.22	Glycol pump alarm.....	43
5.2	Unit Pumpdown Alarms.....	44
5.2.1	UnitOff EvpEntWTempSen - Evaporator Entering Water Temperature (EWT) sensor fault	44
5.2.2	UnitOffEvapLvgWTempSen - Evaporator Leaving Water Temperature (LWT) sensor fault	44
5.2.3	UnitOffAmbienTempSen - Outside Air Temperature sensor fault	44
5.2.4	OAT:Lockout - Outside Air Temperature (OAT) Lockout (only in Cooling Mode).....	45
5.2.5	UnitOffEvpWTempInvtrd – Heat Recovery Water Temperature inverted.....	45
5.2.6	ExternalPumpdown - External Pumpdown	45
5.3	Unit Rapid Stop Alarms.....	46
5.3.1	Power Failure - Power Failure (only for units with the UPS option)	46
5.3.2	UnitOff EvapFreeze - Evaporator Water freeze alarm	46
5.3.3	UnitOff ExternalAlarm - External alarm.....	46
5.3.4	UnitOff PVM - PVM.....	47
5.3.5	UnitOff EvapWaterFlow - Evaporator Water Flow Loss alarm	47
5.3.6	UnitOff MainContrCommFail – Main Controller Communication Error.....	47
5.3.7	UnitOff CC1CommFail - Circuit 1 – CC1 Communication Error.....	48
5.3.8	UnitOff CC2CommFail - Circuit 2 – CC2 Communication Error.....	48
5.3.9	UnitOffEmergency Stop – Emergency Stop.....	48
5.3.10	Glycol Water Freeze alarm	49
5.4	Circuit Events.....	49
5.4.1	Cx CompXStartFail – Compressor starting fail event.....	49
5.4.2	Cx DischTempUnload – High Discharge Temperature Unload event	49
5.4.3	Cx EvapPressUnload – Low Evaporator Pressure Unload event	50
5.4.4	Cx CondPressUnload – High Condenser Pressure Unload event	50
5.4.5	Cx HighPressPd – High Pressure during Pumpdown event	50
5.4.6	Cx Fan Error	51
5.4.7	Cx Fans Communication Error.....	51
5.4.8	Cx Fan Over V.....	51
5.4.9	Cx Fan Under V.....	52
5.4.10	CxStartFail - Start Fail	52
5.5	Circuit Alerts.....	53
5.5.1	CmpX Protection – Compressor Protection	53
5.5.2	CompXOff DischTmp CompXSenf – Discharge Temperature of compressor sensor fault	53
5.5.3	Cx Off LiquidTempSen - Liquid Temperature Sensor fault	53
5.6	Circuit Pumpdown Stop Alarms.....	54
5.6.1	Cx Off DischTmpSen - Discharge Temperature Sensor fault	54
5.6.2	CxOff OffSuctTempSen - Suction Temperature Sensor fault	54
5.6.3	CxOff GasLeakage - Gas Leakage fault.....	54
5.7	Circuit Rapid Stop alarms.....	55
5.7.1	CxOff CondPressSen - Condensing Pressure sensor fault	55
5.7.2	CxOff EvapPressSen - Evaporating Pressure sensor fault.....	55
5.7.3	CxOff DischTmpHigh - High Discharge Temperature Alarm.....	55
5.7.4	CxOff CondPressHigh – High Condensing Pressure alarm.....	56
5.7.5	CxOff EvapPressLow - Low Pressure alarm.....	56
5.7.6	CxOff RestartFault – Restart Fault.....	57
5.7.7	CxOff MechHighPress - Mechanical High Pressure Alarm	57
5.7.8	CxOff NoPressChgStart - No Pressure Change At Start Alarm.....	58
5.7.9	CompXAlm – Compressor starting fail alarm.....	58
5.7.10	Cx FailedPumpdown - Failed Pumpdown procedure.....	58
5.7.11	CxOff LowPrRatio - Low Pressure Ratio Alarm	59

5.7.12	Fan Fault	59
5.7.13	Fans Modbus Communication Failure	59
5.7.14	CxOff Low DSH – DSH too low.....	60
5.7.15	CxOff Drift Suct temp.....	60

1 SAFETY CONSIDERATIONS

1.1 General

Installation, start-up and servicing of equipment can be hazardous if certain factors particular to the installation are not considered: operating pressures, presence of electrical components and voltages and the installation site (elevated plinths and built-up up structures). Only properly qualified installation engineers and highly qualified installers and technicians, fully trained for the product, are authorized to install and start-up the equipment safely.

During all servicing operations, all instructions and recommendations, which appear in the installation and service instructions for the product, as well as on tags and labels fixed to the equipment and components and accompanying parts supplied separately, must be read, understood and followed.

Apply all standard safety codes and practices.

Wear safety glasses and gloves.



Do not operate on a faulty fan, pump or compressor before the main switch has been shut off. Overtemperature protection is auto-reset, therefore the protected component may restart automatically if temperature conditions allow it.

In some unit a push button is placed on a door of the unit electrical panel. The button is highlighted by a red color in yellow background. A manual pressure of the emergency stop button stops all loads from rotating, thus preventing any accident which may occur. An alarm is also generated by the Unit Controller. Releasing the emergency stop button enables the unit, which may be restarted only after the alarm has been cleared on the controller.



The emergency stop causes all motors to stop but does not switch off power to the unit. Do not service or operate on the unit without having switched off the main switch.

1.2 Before switching the unit

Before switching on the unit read the following recommendations:

- when all the operations and all the settings have been carried out, close all the switchbox panels;
- the switchbox panels can only be opened by trained personnel;
- when the UC requires to be accessed frequently the installation of a remote interface is strongly recommended;
- LCD display of the unit controller may be damaged by extremely low temperatures (see chapter 2.4). For this reason, it is strongly recommended to never power off the unit during winter, especially in cold climates.

1.3 Avoid electrocution

Only personnel qualified in accordance with IEC (International Electrotechnical Commission) recommendations may be permitted access to electrical components. It is particularly recommended that all sources of electricity to the unit be shut off before any work is begun. Shut off main power supply at the main circuit breaker or isolator.

IMPORTANT: This equipment uses and emits electromagnetic signals. Tests have shown that the equipment conforms to all applicable codes with respect to electromagnetic compatibility.



Direct intervention on the power supply can cause electrocution, burns or even death. This action must be performed only by trained persons.



RISK OF ELECTROCUTION: Even when the main circuit breaker or isolator is switched off, certain circuits may still be energized, since they may be connected to a separate power source.



RISK OF BURNS: Electrical currents cause components to get hot either temporarily or permanently. Handle power cable, electrical cables and conduits, terminal box covers and motor frames with great care.



In accordance with the operating conditions the fans can be cleaned periodically. A fan can start at any time, even if the unit has been shut down.

2 GENERAL DESCRIPTION

2.1 Basic Information

Microtech® IV is a system for controlling single or dual-circuit air/water-cooled liquid chillers. Microtech® IV controls compressor start-up necessary to maintain the desired heat exchanger leaving water temperature. In each unit mode it controls the operation of the condensers to maintain the proper condensation process in each circuit.

Safety devices are constantly monitored by Microtech® IV to ensure their safe operation. Microtech® IV also gives access to a Test routine covering all inputs and outputs.

2.2 Abbreviations used

In this manual, the refrigeration circuits are called circuit #1 and circuit #2. The compressor in circuit #1 is labelled Cmp1. The other in circuit #2 is labelled Cmp2. The following abbreviations are used:

A/C	Air Cooled
CEWT	Condenser Entering Water Temperature
CLWT	Condenser Leaving Water Temperature
CP	Condensing Pressure
CSRT	Condensing Saturated Refrigerant Temperature
DSH	Discharge Superheat
DT	Discharge Temperature
E/M	Energy Meter Module
EEWT	Evaporator Entering Water Temperature
ELWT	Evaporator Leaving Water Temperature
EP	Evaporating Pressure
ESRT	Evaporating Saturated Refrigerant Temperature
EXV	Electronic Expansion Valve
HMI	Human Machine Interface
MOP	Maximum operating pressure
SSH	Suction SuperHeat
ST	Suction Temperature
UC	Unit controller (Microtech IV)
W/C	Water Cooled

2.3 Controller Operating Limits

Operation (IEC 721-3-3):

- Temperature -40...+70 °C
- Restriction LCD -20... +60 °C
- Restriction Process-Bus -25...+70 °C
- Humidity < 90 % r.h (no condensation)
- Air pressure min. 700 hPa, corresponding to max. 3,000 m above sea level

Transport (IEC 721-3-2):

- Temperature -40...+70 °C
- Humidity < 95 % r.h (no condensation)
- Air pressure min. 260 hPa, corresponding to max. 10,000 m above sea level.

2.4 Controller Architecture

The overall controller architecture is the following:

- One Microtech IV main controller
- I/O extensions as needed depending on the configuration of the unit
- Communications interface(s) as selected
- Peripheral Bus is used to connect I/O extensions to the main controller.

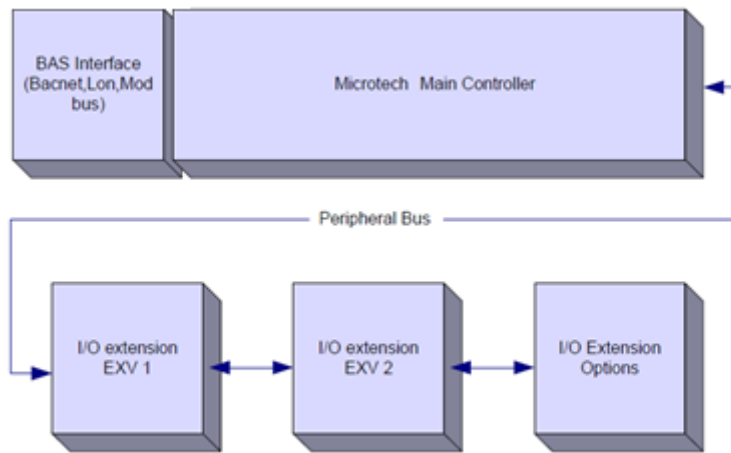

Maintain the correct polarity when connecting the power supply to the boards, otherwise the peripheral bus communication will not operate and the boards may be damaged.

2.5 Communication Modules

Any of the following modules can be connected directly to the left side of the main controller to allow a BAS or other remote interface to function. Up to three can be connected to the controller at a time. The controller should automatically detect and configure itself for new modules after booting up. Removing modules from the unit will require manually changing the configuration.

Module	Siemens Part Number	Usage
BacNet/IP	POL908.00/MCQ	Optional
Lon	POL906.00/MCQ	Optional
Modbus	POL902.00/MCQ	Optional
BACnet/MSTP	POL904.00/MCQ	Optional

3 USING THE CONTROLLER

Microtech 4 does not have an integrated HMI. The interaction with the controller can be done using a mobile app that can be download from the store (Playstore for Android devices and Apple Store for iOS devices).

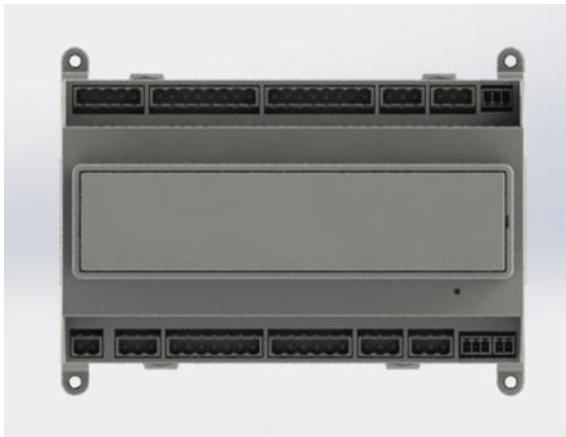

Optionally is possible to order the Remote HMI that can be connected to the available CE+ CE- port on the controller located in the bottom connectors row of the controller.

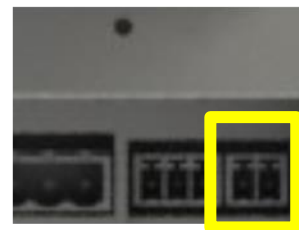

3.1 Navigating

When power is applied to the control circuit, the controller screen will be active and display the Home screen, which can also be accessed by pressing the Menu Button.

An example of the HMI screens is shown in the following picture.

```

Main Menu 1 / 11
Enter Password ▶
Unit Status =
Off: Unit SW
Active Setpt = 7.0 °C
    
```

A bell ringing in the top right corner will indicate an active alarm. If the bell doesn't move it means that the alarm has been acknowledged but not cleared because the alarm condition hasn't been removed. A LED will also indicate where the alarm is located between the unit or circuits.

```

Main Menu 1 / 🔔
Enter Password ▶
Unit Status =
Off: Unit SW
Active Setpt = 7.0 °C
    
```

The active item is highlighted in contrast, in this example the item highlighted in Main Menu is a link to another page. By pressing the push'n'roll, the HMI will jump to a different page. In this case the HMI will jump to the Enter Password page.

```

Enter Password 2 / 2
Enter PW * * * *
    
```

3.2 Passwords

The HMI structure is based on access levels that means that each password will disclose all the settings and parameters allowed to that password level. Basic informations about the status can be accessed without the need to enter the password. The user UC handles two level of passwords:

USER	5321
MAINTENANCE	2526

The following information will cover all data and settings accessible with the maintenance password.

In the Enter Password screen, the line with the password field will be highlighted to indicate that the field on the right can be changed. This represents a setpoint for the controller. Pressing the push'n'roll the individual field will be highlighted to allow an easy introduction of the numeric password.

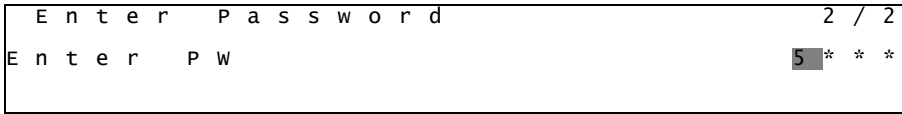

The password will time out after 10 minutes and is cancelled if a new password is entered or the control powers down. Entering an invalid password has the same effect as continuing without a password. It is changeable from 3 to 30 minutes via the Timer Settings menu in the Extended Menus.

3.3 Editing

The Editing Mode is entered by pressing the navigation wheel while the cursor is pointing to a line containing an editable field. Pressing the wheel again cause the new value to be saved and the keypad/display to leave the edit mode and return to the navigation mode.

3.4 Mobile app HMI

The Daikin mAP mobile app HMI is provided for free and aims to simplify the interaction with this Daikin product. The app can be downloaded from the official stores with the following links (scan the QR code to access directly the download pages on the stores).

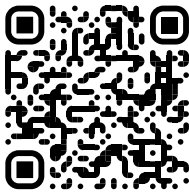

iOS

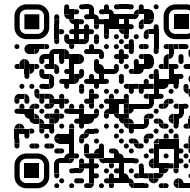

Android

To use the app is needed to pre-register an account and gain access to the specific unit to access. The access will be granted per unit base. A user can access multiple units after the app-tenant authorize this access. The procedure to register an account is in app. It's necessary to follow the sign in link in the app:

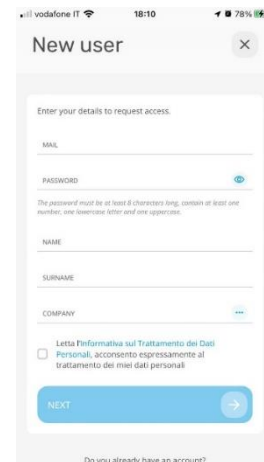
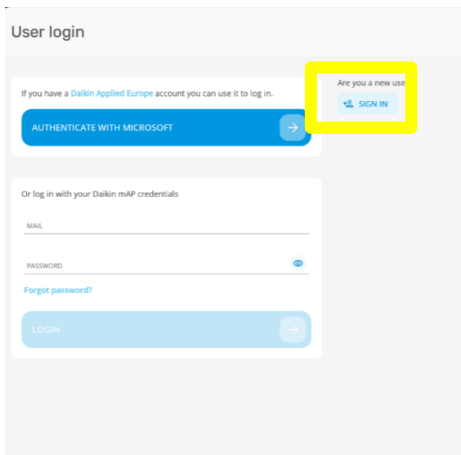

The mobile app will allow you to monitor all the relevant data, change the user related settings, trend data, update chiller software and more to come.

App layout will adapt based on the device where the app is running and will look as follows:

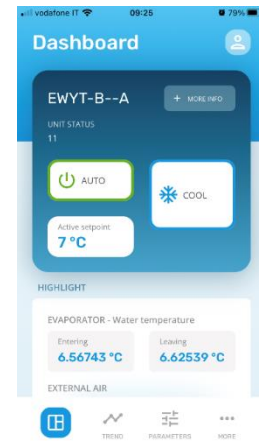
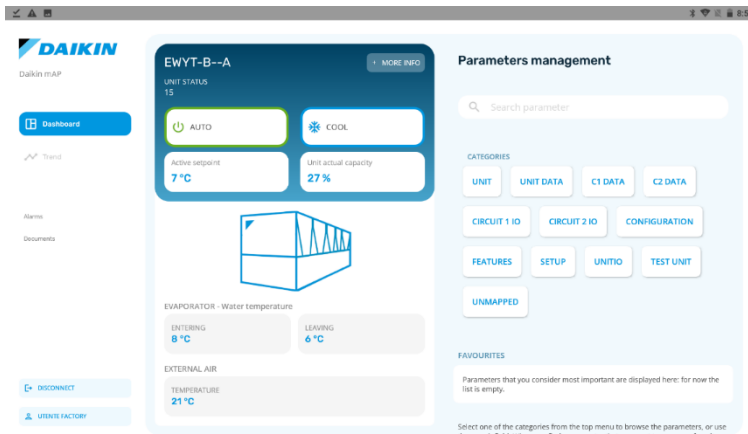

For further information consult the Quick Guide Daikin Map 1.0 → D-EPMAP00101-23_EN

3.5 Basic Control System Diagnostic

Microtech IV controller, extension modules and communication modules are equipped with two status LED (BSP and BUS) to indicate the operational status of the devices. The BUS LED indicates the status of the communication with the controller. The meaning of the two status LED is indicated below.

Main Controller (UC)

BSP LED	Mode
Solid Green	Application running
Solid Yellow	Application loaded but not running (*) or BSP Upgrade mode active
Solid Red	Hardware Error (*)
Flashing Green	BSP startup phase. The controller needs time for starting.
Flashing Yellow	Application not loaded (*)
Flashing Yellow/Red	Fail safe mode (in case that the BSP upgrade was interrupted)
Flashing Red	BSP Error (software error*)
Flashing Red/Green	Application/BSP update or initialization

(*) Contact Service.

Extension modules

BSP LED	Mode	BUS LED	Mode
Solid Green	BSP running	Solid Green	Communication running, I/O working
Solid Red	Hardware Error (*)	Solid Red	Communication down (*)
Flashing Red	BSP Error (*)	Solid Yellow	Communication running but parameter from the application wrong or missing, or uncorrect factory calibration
Flashing Red/Green	BSP upgrade mode		

Communication modules

BSP LED (same for all modules)

BSP LED	Mode
Solid Green	BPS running, communication with controller
Solid Yellow	BSP running, no communication with controller (*)
Solid Red	Hardware Error (*)
Flashing Red	BSP Error (*)
Flashing Red/Green	Application/BSP update

(*) Contact Service.

BUS LED

BUS LED	LON	Bacnet MSTP	Bacnet IP	Modbus
Solid Green	Ready for Communication. (All Parameter loaded, Neuron configured). Doesn't indicate a communication with other devices.	Ready for Communication. The BACnet Server is started. It doesn't indicate an active communication	Ready for Communication. The BACnet Server is started. It doesn't indicate an active communication	All Communication running

BUS LED	LON	Bacnet MSTP	Bacnet IP	Modbus
Solid Yellow	Startup	Startup	Startup. The LED stays yellow until the module receives a IP Address, therefore a link must be established.	Startup, or one configured channel not communicating to the Master
Solid Red	No Communication to Neuron (internal error, could be solved by downloading a new LON application)	BACnet Server down. Automatically a restart after 3 seconds are initiated.	BACnet Server down. Automatic restart after 3 seconds is initiated.	All configured Communications down. Means no communication to the Master. The timeout can be configured. In case that the timeout is zero the timeout is disabled.
Flashing Yellow	Communication not possible to the Neuron. The Neuron must be configured and set online over the LON Tool.			

3.6 Controller maintenance

The controller requires to maintain the installed battery. Every two years it's required to replace the battery. Battery model is: BR2032 and it is produced by many different vendors.

To replace the battery remove the plastic cover of the controller display using a screwdriver as shown in the following:



Be careful to avoid damages to the plastic cover. The new battery shall be placed in the proper battery holder, which is highlighted in the picture, respecting the polarities indicated into the holder itself.

3.7 Optional Remote User Interface

As an option an external Remote HMI can be connected on the UC. The Remote HMI offers the same features as the inbuilt display plus the alarm indication done with a light emitting diode located below the bell button.

All viewing and setpoint adjustments available on the unit controller are available on the remote panel. Navigation is identical to the unit controller as described in this manual.

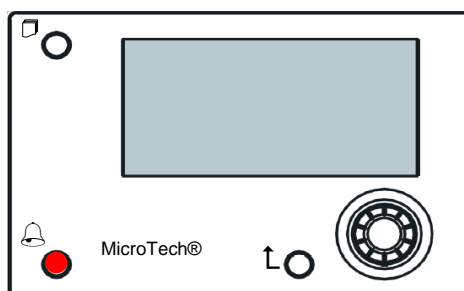

The Remote HMI can be extended up to 700m using the process bus connection available on the UC. With a daisy-chain connection as below, a single HMI can be connected to up to 8 units. Refer to the specific HMI manual for details.

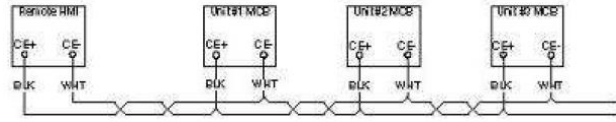

3.8 Embedded Web Interface

The Microtech IV controller has an embedded web interface that can be used to monitor the unit when connected to a local network. It is possible to configure the IP addressing of the Microtech IV as a fixed IP or DHCP depending on the network configuration.

With a common web browser a PC can connect with the unit controller entering the IP address of the controller or the host name, both visible in the “About Chiller” page accessible without entering a password.

When connected, it will be required to enter a username and a password. Enter the following credential to get access to the web interface:

Username: Daikin
Password: Daikin@web

Esegui l'accesso per accedere a questo sito

Autorizzazione richiesta da http://192.168.1.42
La tua connessione a questo sito non è sicura

Nome utente

Password

The Main Menu page will be displayed. The page is a copy of the onboard HMI and follows the same rules in terms of access levels and structure.

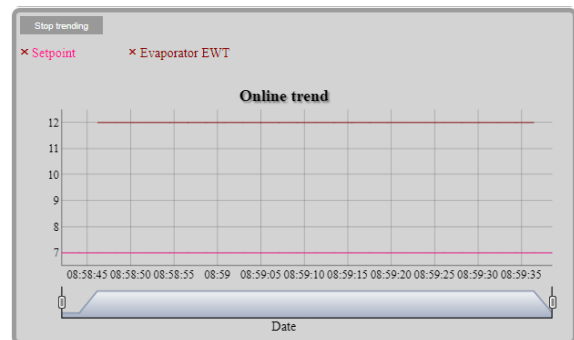
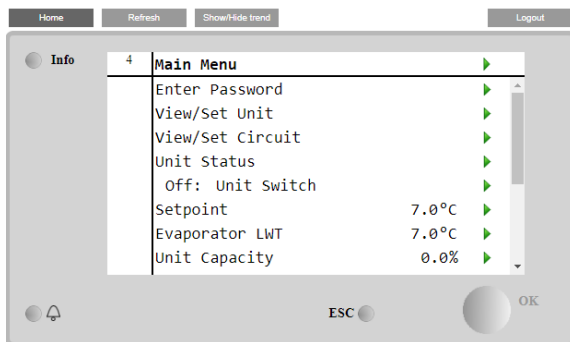

In addition it allows to trend log a maximum of 5 different quantities. It's required to click on the value of the quantity to monitor and the following additional screen will become visible:

Depending on the web browser and its version the trend log feature may not be visible. It's required a web browser supporting HTML 5 like for example:

- Microsoft Internet Explorer v.11,
- Google Chrome v.37,
- Mozilla Firefox v.32.

These software are only an example of the browser supported and the versions indicated have to be intended as minimum versions.

4 WORKING WITH THIS UNIT

4.1 Chiller On/Off

Starting from factory setup, unit On/Off can be managed by the user using the selector **Q0**, placed in the electrical panel, which can switch between three positions: **0 – Local – Remote**.

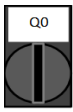

0 Unit is disabled



Loc (Local) Unit is enabled to start the compressors



Rem (Remote) Unit On/Off is managed through the “Remote On/Off” physical contact.
 Closed contact means unit enabled.
 Opened contact means unit disabled.
 Refer to the electrical wiring diagram, Field Wiring Connection page, to find the references about Remote On/Off contact. Generally, this contact is used to bring out from the electrical panel the on/off selector.

Unit controller provides also additional software features to manage unit start/stop, that are set by default to allow unit start:

1. Keypad On/Off
2. Scheduler (Time programmed On/Off)
3. Network On/Off (optional with communication modules)

4.1.1 Keypad On/Off

In the main page, scroll down until **Unit Enable** menu, where are available all settings to manage unit and circuits start/stop.

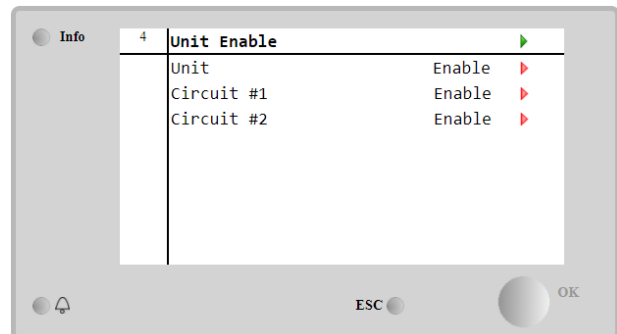
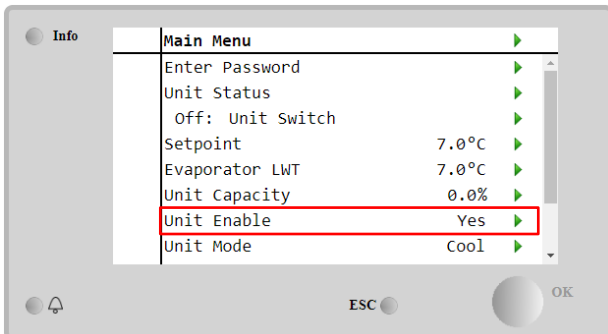

Parameter	Range	Description
Unit	Disable	Unit disabled
	Enable	Unit enabled
	Scheduler	Unit start/stop can be time programmed for each weekday
Circuit #X	Disable	Circuit #X disabled
	Enable	Circuit #X enabled
	Test	Circuit #X in test mode. This feature has to be used only from trained person or Daikin service

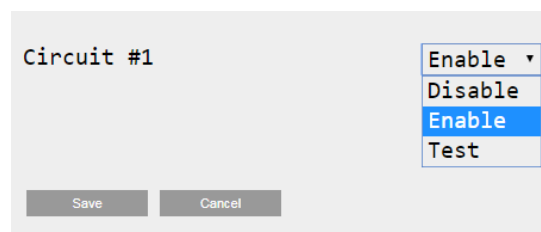
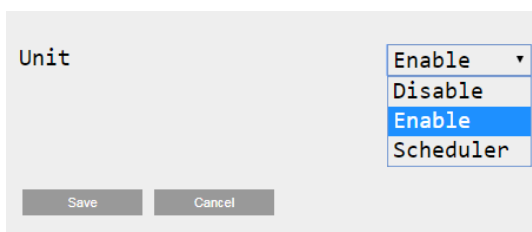

4.1.2 Scheduler and Silent mode functionalities

The Scheduler function can be used when is required an automatic chiller start/stop programming.

To use this function, follow below instructions:

1. Q0 selector = Local
2. Unit Enable = Scheduler
3. Controller date and time properly set

Scheduler programming is available going in **Main Page** → **View/Set Unit** → **Scheduler** menu.

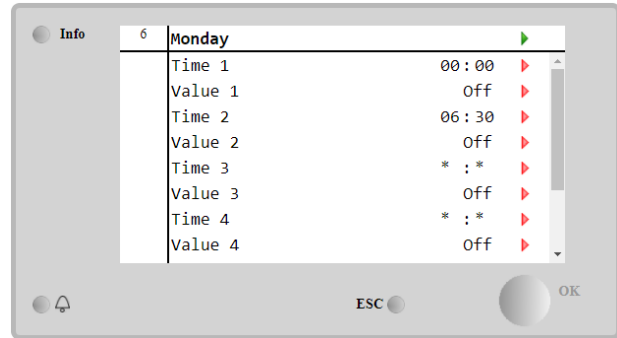
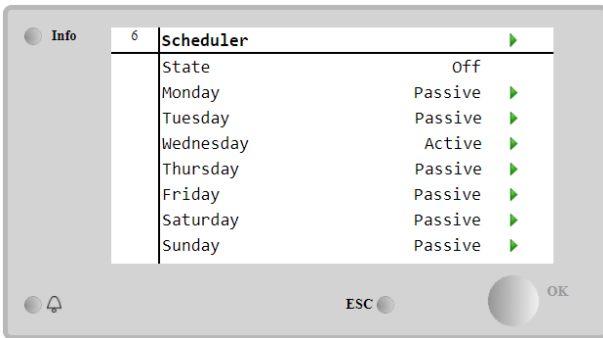

For each weekday can be programmed up to six time bands with a specific operating mode. First operating mode starts at Time 1, ends at Time 2 when will start the second operating mode and so on until the latest.

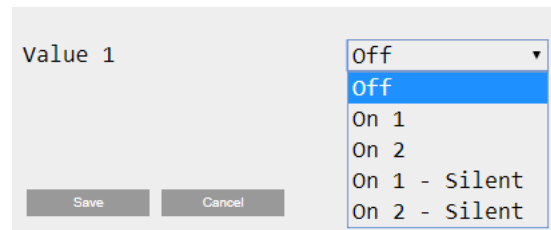

Depending on unit type, different operating modes are available:

Parameter	Range	Description
Value 1	Off	Unit disabled
	On 1	Unit enabled – Water setpoint 1 selected
	On 2	Unit enabled – Water setpoint 2 selected
	On 1 - Silent	Unit enabled – Water setpoint 1 selected – Fan silent mode enabled
	On 2 - Silent	Unit enabled – Water setpoint 2 selected – Fan silent mode enabled

When the **Fan Silent Mode** function is enabled the chiller noise level is reduced decreasing the maximum speed allowed for fans. Following table reports how much maximum speed is decreased for the different unit types.

Unit noise class	Normal maximum fan speed [rpm]	Silent mode maximum fan speed [rpm]
SS & XS	1100 or 950	720
SR	810	500
XR	720	500



All data reported in the table, will be respected only if the chiller is operating within its operating limits.

The Fan Silent Mode function can be enabled only for units equipped with VFD fans in cooling mode.

4.1.3 Network On/Off

Chiller On/Off can be managed also with serial protocol, if the unit controller is equipped with one or more communication modules (BACNet, Modbus or LON). In order to control the unit over the network, follow below instructions:

1. Q0 selector = Local
2. Unit Enable = Enable
3. Control Source = Network
4. Close the contact Local/Network Switch, when required!

4.2 Water Setpoints

Purpose of this unit is to cool or to heat (in case of heat pump) the water temperature, to the setpoint value defined by the user and displayed in the main page:

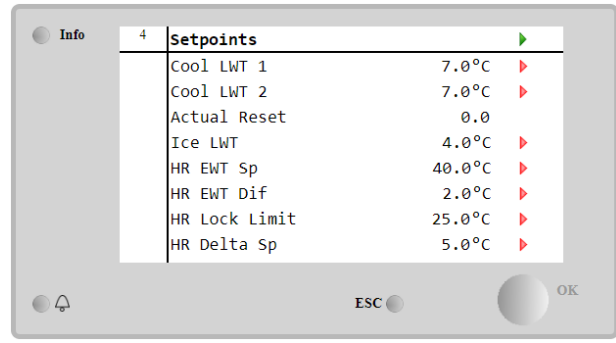
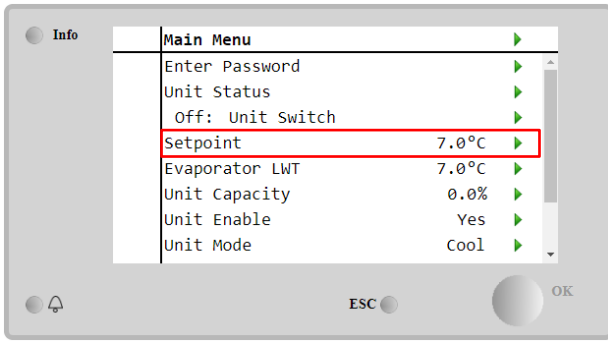

The unit can work with a primary or a secondary setpoint, that can be managed as indicated below:

1. Keypad selection + Double Setpoint digital contact
2. Keypad selection + Scheduler Configuration
3. Network
4. Setpoint Reset function

As first step the primary and secondary setpoints need to be defined. From main menu, with user password, press on **Setpoint**.

Parameter	Range	Description
Cool LWT 1	Ranges of the Cool, Heat, Ice setpoint are reported in the IOM of every specific unit.	Primary cooling setpoint.
Cool LWT 2		Secondary cooling setpoint.
Actual Reset		This item is visible only when the Setpoint Reset function is enabled and it shows the actual reset applied to the basic setpoint
Heat LWT 1		Primary heating setpoint.
Heat LWT 2		Secondary heating setpoint.
Ice LWT		Setpoint for Ice mode.

The change between primary and secondary setpoint can be performed using the Double setpoint contact, always available in the user terminal box, or through the Scheduler function.

Double setpoint contact works as below:

- Contact opened, the primary setpoint is selected
- Contact closed, the secondary setpoint is selected

In order to change between primary and secondary setpoint with the Scheduler, refer to the section 4.1.2.



When the scheduler function is enabled, the Double setpoint contact is ignored



When the operating mode Cool/Ice w/Glycol is selected, the Double Setpoint contact will be used to switch between the Cool and Ice mode, producing no change on the active setpoint

To modify the active setpoint through network connection, refer to Network control section 4.5.

The active setpoint can further modified using the Setpoint Reset function as explained in the section 4.10.2.

4.3 Unit Mode

The Unit Mode is used to define if the chiller is working to produce chilled or heated water. Current mode is reported in the main page to the item Unit Mode.

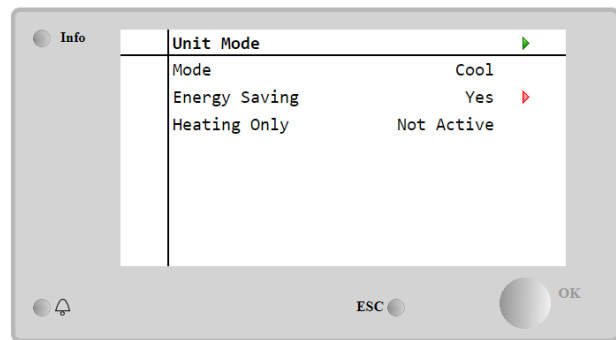
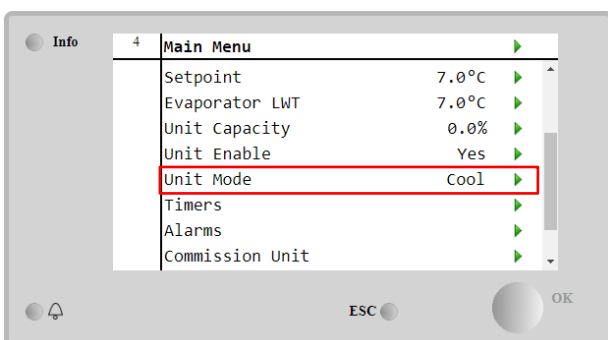

Depending on the unit type, different operating modes can be selected entering, with maintenance password, in the **Unit Mode** menu. In the table below are listed and explained all modes.

Parameter	Range	Description	Unit Range	
Mode	Cool	Set if chilled water temperature up to 4°C is required. No glycol is generally needed in the water circuit unless ambient temperature may reach low values.	A/C	
	Cool w/Glycol	Set if chilled water temperature below 4°C is required. This operation requires proper glycol/water mixture in the evaporator water circuit.	A/C	
	Cool/Ice w/Glycol	Set in case a dual cool/ice mode is required. The switch between the two modes is performed using the contact physical Double Setpoint. Double Setpoint opened: the chiller will work in cooling mode with the Cool LWT being as the Active Setpoint. Double Setpoint closed: The chiller will work in Ice mode with the Ice LWT as the Active Setpoint.	A/C	
	Ice w/Glycol	Set if Ice storage is required. The application requires the compressors to operate at full load until the ice bank is completed, and then to stop for at least 12 hours. In this mode the compressor(s) will not operate at part load but will work only in on/off mode.	A/C	
	The following modes allow to switch the unit between heat mode and one of the previous cool mode (Cool, Cool w/Glycol, Ice)			
	Heat/Cool	Set in case a dual cool/heat mode is required. This setting implies an operation with double functioning which is activated through the Cool/Heat switch on the electric box. <ul style="list-style-type: none"> Switch COOL: The chiller will work in cooling mode with the Cool LWT as the Active Setpoint. Switch HEAT: The chiller will work in heat pump mode with the Heat LWT as the Active Setpoint. 	Heat Pump Only	
	Heat/Cool w/Glycol	Set in case a dual cool/heat mode is required. This setting implies an operation with double functioning which is activated through the Cool/Heat switch on the electric box. <ul style="list-style-type: none"> Switch COOL: The chiller will work in cooling mode with the Cool LWT as the Active Setpoint. Switch HEAT: The chiller will work in heat pump mode with the Heat LWT as the Active Setpoint. 	A/C	
Heat/Ice w/Glycol	Set in case a dual Ice/Heat mode is required. This setting implies an operation with double functioning which is activated through the Cool/Heat switch on the electric box. <ul style="list-style-type: none"> Switch ICE: The chiller will work in cooling mode with the Ice LWT as the Active Setpoint. Switch HEAT: The chiller will work in heat pump mode with the Heat LWT as the Active Setpoint. 	A/C		
Test	Enables the Manual Control of the unit. The manual test feature helps in debugging and checking the operational status of actuators. This feature is accessible only with the maintenance password in the main menu. To activate the test feature is required to disable the Unit from the Q0 switch and change the available mode to Test.	A/C		
Energy Saving	No, Yes	Disable/Enable of the energy saving function		
Heating only	Not Active, Active	Indicates if the unit can work ONLY in heating mode or not	Heat Pump only	

Like the On/Off and setpoint control, also the unit mode can be modified from network.

4.3.1 Heat/Cool Switch (Heat Pump Only)

Starting from factory setup, Heat mode switch can be managed by the user using the selector **QHP**, placed in the electrical panel, which can switch between three positions: **0 – 1**.



chiller Unit will work in Cooling Mode



Loc (Local) Unit will work in Heating mode



Rem
(Remote)

Unit Operating mode is managed through the "Remote" control through BMS communication.

In order to enable the Heat mode, the Unit mode must be set in "Heat/Cool" mode, and the QHP switch must be set in Loc position.

4.3.2 Energy Saving mode

Some unit types provide the possibility to enable an energy saving function, that reduces the power consumption deactivating the compressors crankcase heater, when the chiller is Disabled.

This mode implies that the time needed to start the compressors, after an Off period, could be delayed until a maximum of 90 minutes.

For time critical application, the energy saving function can be disabled by the user to ensure the compressor start within 1 minute from unit On command.

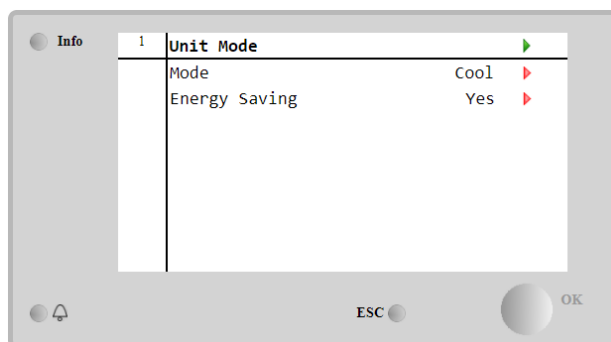
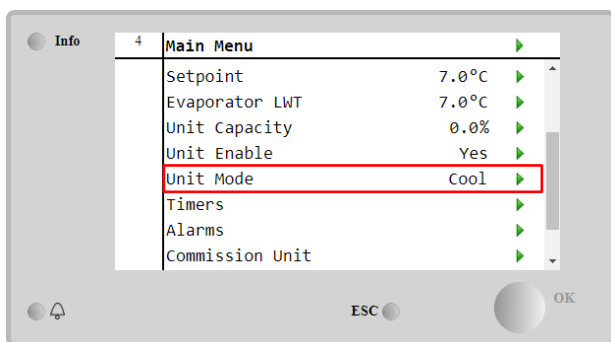

4.4 Unit Status

Unit controller provides in the main page some information about chiller status. All chiller states are listed and explained below:

Parameter	Overall status	Specific status	Description
Unit Status	Auto:		Unit is in Auto control. The pump is running and at least one compressor is running.
		wait For Load	Unit is in standby because the thermostatic control satisfies the active setpoint.
		Water Recirc	Water pump is running in order to equalize the water temperature in the evaporator.
		wait For Flow	Unit pump is running but the flow signal still indicates a lack of flow through the evaporator.
		Max Pulldown	Unit thermostatic control is limiting the unit capacity as the water temperature is dropping too quickly.
		Capacity Limit	Demand limit has been hit. Unit capacity will not further increase.
		Current Limit	Maximum current has been hit. Unit capacity will not further increase.
	Off:	Silent Mode	Unit is running and Silent Mode is enabled
		Master Disable	Unit is disabled by the Master Slave function
		Ice Mode Timer	This status can be shown only if the unit can work in Ice Mode. The unit is off because the Ice setpoint has been satisfied. Unit will remain off until the Ice Timer has expired.
		OAT Lockout	The unit cannot run because the Outside Air Temperature is below the limit foreseen for the condenser temperature control system installed in this Unit. If the Unit has to run anyway, check with your local maintenance how to proceed.
		Circuits Disabled	No circuit is available to run. All circuits can be disabled by their individual enable switch or can be disabled by a component safety condition active or can be disabled by keypad or can be all in alarms. Check the individual circuit status for further details.
		Unit Alarm	A unit alarm is active. Check the alarm list to see what is the active alarm inhibiting the unit to start and check if the alarm can be cleared. Refer to section 5. before proceeding.
		Keypad Disable	The Unit has been disabled by keypad. Check with your local maintenance if it can be enabled.
Network Disabled	Unit is disabled by Network.		

		Unit Switch	The Q0 selector is set to 0 or the Remote On/Off contact is opened.
		Test	Unit mode set to Test. This mode is activated to check operability of onboard actuators and sensors. Check with the local maintenance if the Mode can be reverted to the one compatible with unit application (View/Set Unit – Set-Up – Available Modes).
		Scheduler Disable	Unit is disabled by Scheduler programming
	Pumpdown		Unit is performing the pumpdown procedure and it will stop within few minutes

4.5 Network Control

When the unit controller is equipped with one or more communication modules the **Network Control** feature can be enabled, which gives the possibility to control the unit via serial protocol (Modbus, BACnet or LON). To allow unit's control from network, follow below instructions:

1. Close the physical contact "Local/Network Switch". Refer to unit electrical wiring diagram, Field Wiring Connection page, to find the references about this contact.
2. Go to Main Page → View/Set Unit → Network Control
Set Controls Source = Network



Network Control menu returns all main values received from serial protocol.

Parameter	Range	Description
Control Source	Local	Network control disabled
	Network	Network control enabled
Enable	Enable/Disable	On/Off command from network
Mode	-	Operating mode from network
Cool LWT	-	Cooling water temperature setpoint from network
Ice LWT	-	Ice water temperature setpoint from network
Heat LWT	-	Heating water temperature setpoint from network
HR EWT Sp	-	Heat recovery water temperature setpoint from network
Capacity Limit	-	Capacity limitation from network
HR Enable	Enable/Disable	On/Off command from network
Freecooling	-	On/Off command from network
Compressors	-	Compressors enable from network

Refer to communication protocol documentation for specific registers addresses and the related read/write access level.

4.6 Thermostatic Control

Thermostatic control settings allow to set up the response to temperature variations. Default settings are valid for most application, however plant specific conditions may require adjustments in order to have a smooth control or a quicker response of the unit.

The control will start the first compressor if the controlled temperature is higher (Cool Mode) or lower (Heat Mode) than the active setpoint of at least a Start Up DT value, whereas other compressors are started, step by step, if the controlled temperature is higher (Cool Mode) or lower (Heat Mode) than the active setpoint (AS) of at least a Stage Up DT (SU) value. Compressors stop if performed following same procedure looking to the parameters Stage Down DT and Shut Down DT.

	Cool Mode	Heat Mode
First compressor start	Controlled Temperature > Setpoint + Start Up DT	Controlled Temperature < Setpoint - Start Up DT
Other compressors start	Controlled Temperature > Setpoint + Stage Up DT	Controlled Temperature < Setpoint - Stage Up DT
Last compressor stop	Controlled Temperature < Setpoint - Shut Dn DT	Controlled Temperature > Setpoint - Shut Dn DT
Other compressors stop	Controlled Temperature < Setpoint - Stage Dn DT	Controlled Temperature > Setpoint - Stage Dn DT

A qualitative example of compressors start-up sequence in cool mode operation is shown in the graph below.

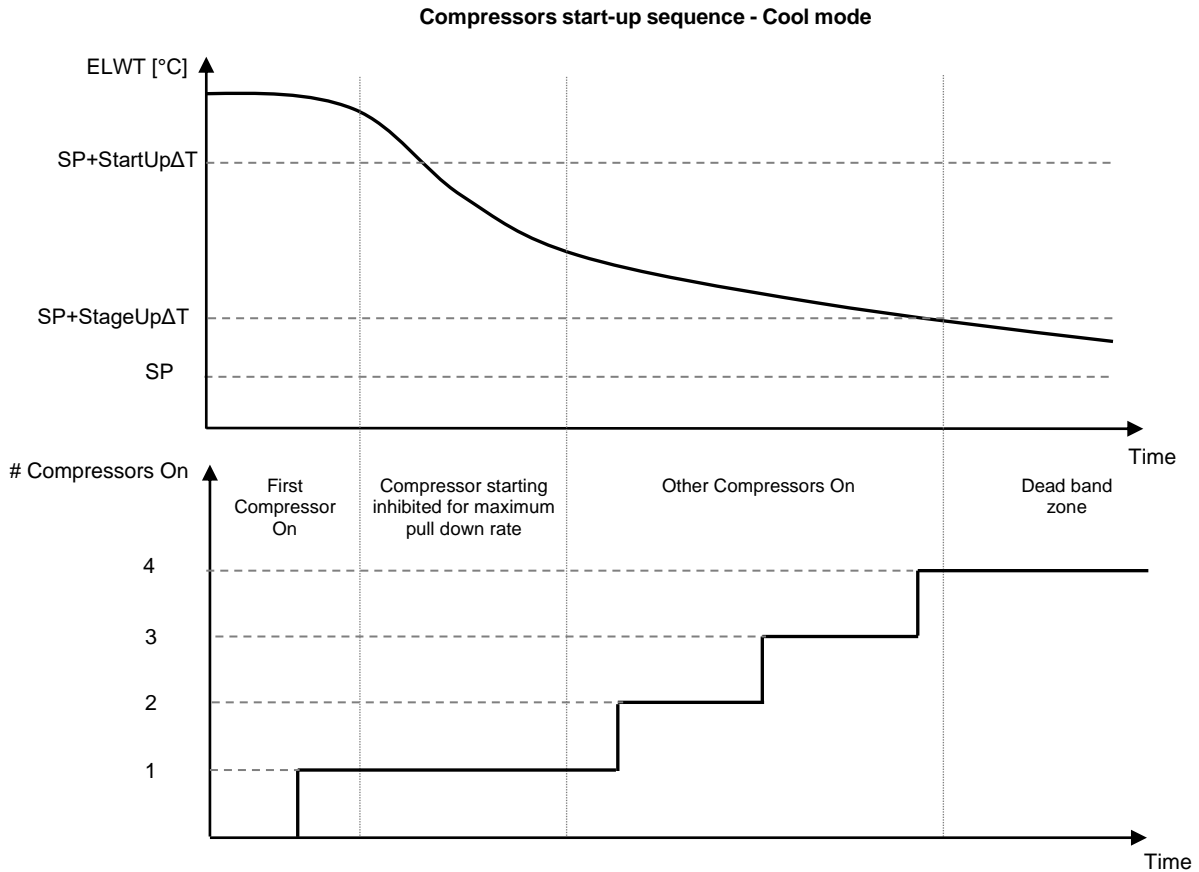

Thermostatic control settings are accessible from **Main Page** → **Thermostatic Control**

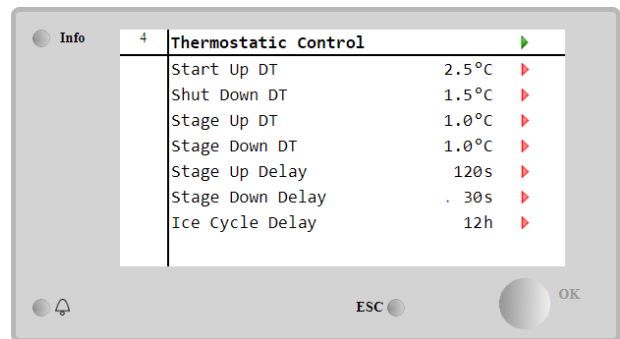
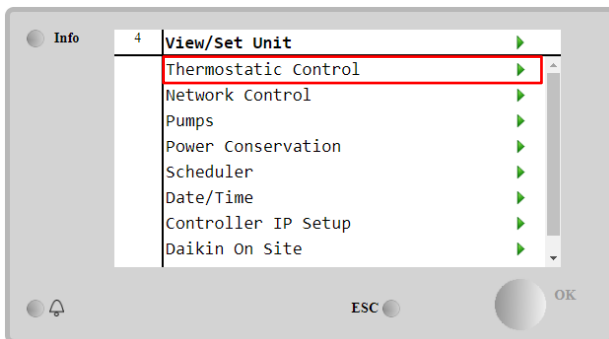

Parameter	Range	Description
Start Up DT	0.5-8 °C	Delta temperature respect the active setpoint to start the unit (startup of first compressor)
Shut Down DT	0.5-3 °C	Delta temperature respect the active setpoint to stop the unit (shutdown of latest compressor)
Stage Up DT	0.5-2.5 °C	Delta temperature respect the active setpoint to start a compressor
Stage Down DT	0.5-1.5 °C	Delta temperature respect the active setpoint to stop a compressor
Stage Up Delay	120-480s	Minimum time between the compressors' startup
Stage Down Delay	10-60s	Minimum time between the compressors' shutdown
Ice Cycle Delay	1-23h	Unit standby period during Ice mode operation

4.7 Date/Time

The unit controller is able to take stored the actual date and time, that are used for:

1. **Scheduler**
2. Cycling of standby chiller with Master Slave configuration
3. **Alarms Log**

Date and time can be modified going in **View/Set Unit** → **Date/Time**

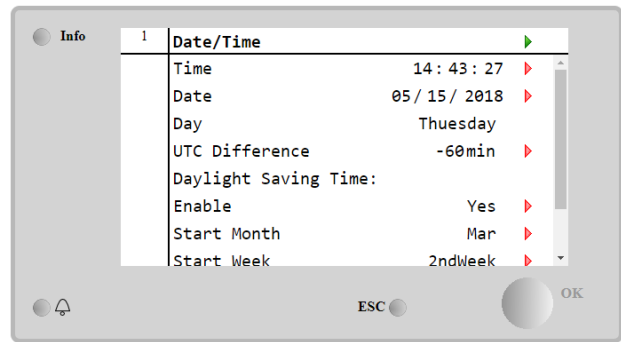
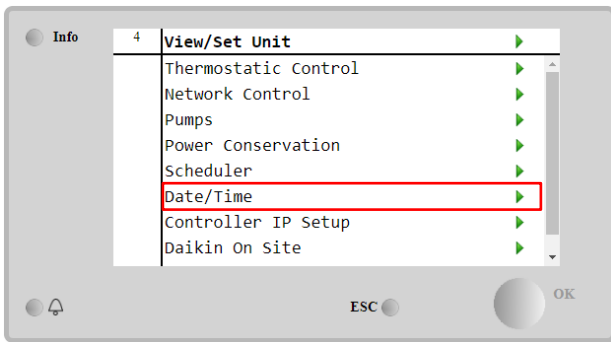

Parameter	Range	Description
Time		Actual date. Press to modify. Format is hh:mm:ss
Date		Actual time. Press to modify. Format is mm/dd/yy
Day		Returns the day of the week.
UTC Difference		Coordinated universal time.
Daylight Saving Time:		
Enable	No, Yes	It is used to enable/disable the automatic switch of the Daylight Saving Time
Start Month	NA, Jan...Dec	DayLight Saving time start month
Start week	1st...5th week	DayLight Saving time start week
End Month	NA, Jan...Dec	DayLight Saving time end month
End week	1st...5th week	DayLight Saving time end week



Remember to check periodically the controller battery in order to maintain updated date and time even when there is no electrical power. Refer to controller maintenance section.

4.8 Pumps

The UC can manage one or two water pumps. Number of pumps and their priority can be set from **Main Page**→**View/Set Unit**→**Pumps**.

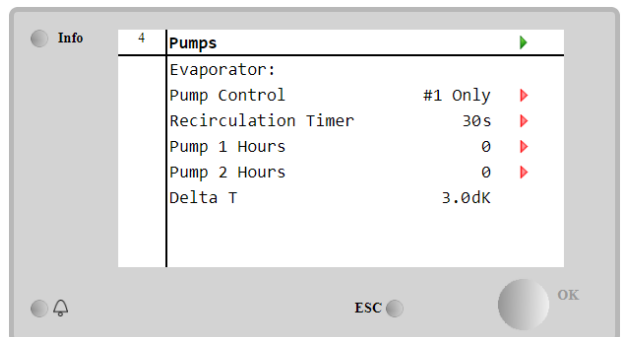
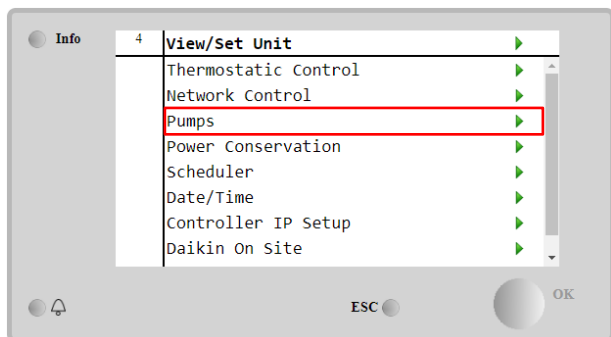

Parameter	Range	Description
Pump Control	#1 Only	Set to this in case of single pump or twin pump with only #1 operational (f.e. in case of maintenance on #2)
	#2 Only	Set to this in case of twin pump with only #2 operational (f.e. in case of maintenance on #1)
	Auto	Set for automatic pump start management. At each chiller start, the pump with the least number of hours will be
	#1 Primary	Set to this in case of twin pump with #1 running and #2 as a backup
	#2 Primary	Set to this in case of twin pump with #2 running and #1 as a backup
Recirculation Timer		Minimum time required within flow switch has to in order to allow unit startup
Pump 1 Hours		Pump 1 running hours
Pump 2 Hours		Pump 2 running hours

4.9 External Alarm

The External Alarm is a digital contact that can be used to communicate to the UC an abnormal condition, coming from an external device connected to the unit. This contact is located in the customer terminal box and depending on the configuration can cause a simple event in the alarm log or also the unit stop. The alarm logic associated to the contact is the following:

Contact state	Alarm State	Note
Opened	Alarm	The alarm is generated if the contact remains opened for at least 5 seconds
Closed	No Alarm	The alarm is reset just the contact is closed

The configuration is performed from the **Commissioning à Configuration à Options** menu

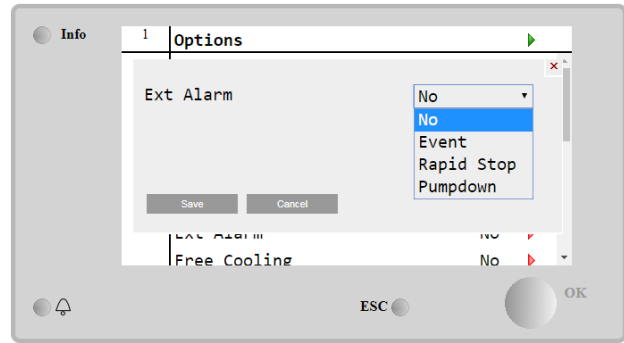
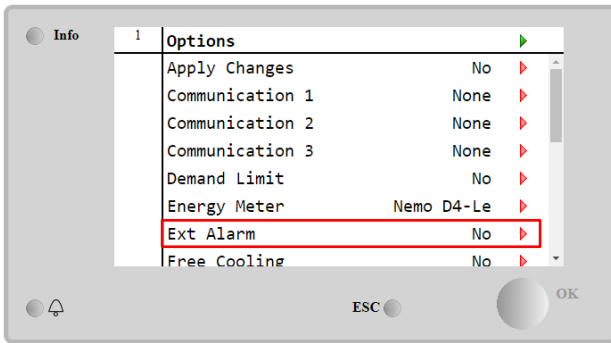

Parameter	Range	Description
Ext Alarm	Event	Event configuration generates an alarm in the controller but takes the unit running
	Rapid Stop	Rapid Stop configuration generates an alarm in the controller and performs a rapid stop of the unit
	Pumpdown	Pumpdown configuration generates an alarm in the controller and performs a pumpdown procedure to stop the unit.



At the end of the configuration of the External Alarm, execute an Apply Changes in order to make the configurations made effective.

4.10 Power Conservation

In this chapters will be explained the functions used to reduce the unit power consumption:

1. Demand Limit
2. Setpoint Reset

4.10.1 Demand Limit

The "Demand limit" function allows the unit to be limited to a specified maximum load. Capacity limit level is regulated using an external 4-20 mA signal with a linear relationship shown in the picture below. A signal of 4 mA indicates the maximum capacity available whereas a signal of 20 mA indicates the minimum capacity available. In order to enable this option, go to Main Menu → Commission Unit → Configuration → Options and set the Demand Limit parameter to Yes.



At the end of the Demand Limit configuration, execute an Apply Changes in order to make the configurations made effective.

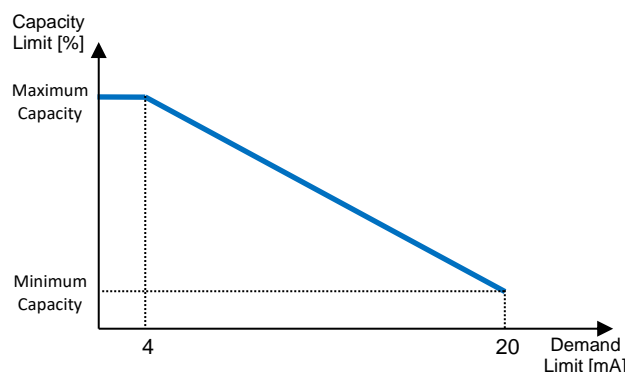

Graph 1 Demand Limit[mA] vs Capacity Limit[%]

It is worth pointing out that it is not possible to shut down the unit using the demand limit function, but only to unload it to its minimum capacity.

Note that this function does a real capacity limitation only if the unit is equipped with Screw compressors. In case of Scroll compressors, the demand limit operates a discretization of the overall unit capacity according to the actual number of compressors, and, depending on the external signal value, it enables only a subset of the total number of compressors, as shown in table below:

Number of Compressor	Demand Limit Signal [mA]	Maximum number of compressors On
4	4 < < 8	4
	8 < < 12	3
	12 < < 16	2
	16 < < 20	1
5	4 < < 7.2	5
	7.2 < < 10.4	4
	10.4 < < 13.6	3
	13.6 < < 16.8	2
	16.8 < < 20.0	1
6	4 < < 6.7	6
	6.7 < < 9.3	5
	9.3 < < 12	4
	12 < < 14.7	3
	14.7 < < 17.3	2
	17.3 < < 20	1
7	4 < < 6.29	7
	6.29 < < 8.58	6
	8.58 < < 10.87	5
	10.87 < < 13.16	4
	13.16 < < 15.45	3
	15.45 < < 17.74	2
	17.73 < < 20	1
8	4 < < 6	8
	6 < < 8	7
	8 < < 10	6
	10 < < 12	5
	12 < < 14	4
	14 < < 16	3
	16 < < 18	2
	18 < < 20	1

All info about this function is reported in the **Main Menu → View/Set Unit → Power Conservation → Demand Limit**

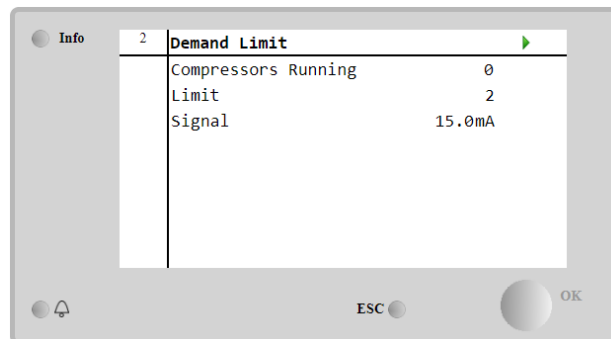

4.10.2 Setpoint Reset

The “Setpoint Reset” function is able to override the chilled water temperature active setpoint when certain circumstances occur. The aim of this function is to reduce the unit energy consumption whilst maintaining the same comfort level. To this purpose, three different control strategies are available:

- Setpoint Reset by Outside Air Temperature (OAT)
- Setpoint Reset by an external signal (4-20mA)
- Setpoint Reset by Evaporator ΔT (EWT)

In order to set the desired setpoint-reset strategy, go to **Main Menu → Commission Unit → Configuration → Options** and modify the **Setpoint Reset** parameter, according to the following table:

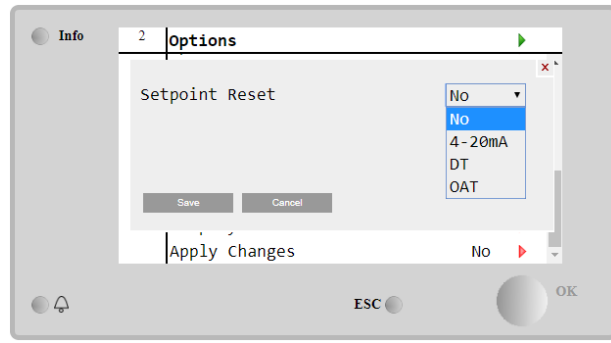
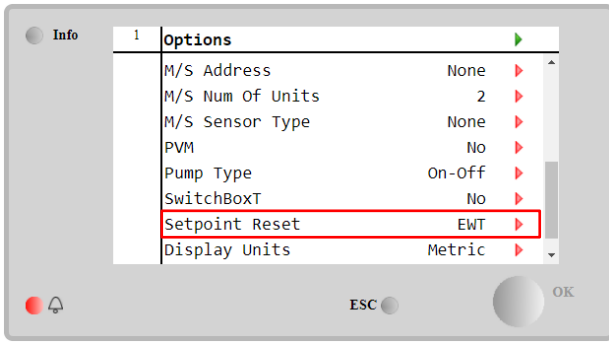

At the end of the Setpoint Reset configuration, execute an Apply Changes in order to make the configurations made effective.

Parameter	Range	Description
LWT Reset	No	Setpoint reset not enabled
	4-20mA	Setpoint reset enabled by an external signal between 4 and 20mA
	DT	Setpoint reset enabled by Evaporator Water Temperature
	OAT	Setpoint reset enabled by Outside Air Temperature

Each strategy needs to be configured (although a default configuration is available) and its parameters can be set navigating to **Main Menu → View/Set Unit → Power Conservation → Setpoint Reset**.

Note that the parameters corresponding to a specific strategy will be available only once the Setpoint Reset has been set to a specific value and the UC has been restarted.

4.10.2.1 Setpoint Reset by OAT (A/C units only)

When the **OAT** is selected as Setpoint Reset option, the LWT active setpoint(AS) is calculated applying a correction to the basic setpoint that depends on the ambient temperature (OAT) and on the current Unit Mode (Heating mode or Cooling mode). Several parameters can be configured, and they are accessible from the Setpoint Reset menu, as shown below:

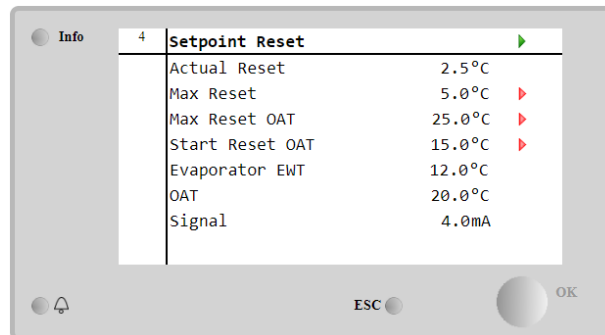

Parameter	Default	Range	Description
Actual Reset			Actual Reset shows which is the correction that will applied to the base setpoint
Max Reset (MR)	5.0°C	0.0°C÷10.0° C	Max Reset setpoint. It represents the maximum temperature variation that the selection of the OAT option can cause on the LWT.
Max Reset OAT (MROAT)	15.5°C	10.0°C÷29.4° C	It represents the “threshold temperature” that correspond to the maximum setpoint variation.
Start OAT Reset (SROAT)	23.8°C	10.0°C÷29.4° C	It represents the “threshold temperature” of the OAT to activate the LWT setpoint reset, i.e. the LWT setpoint is overwritten only if the OAT reaches/overpasses the SROAT.
Delta T			Is the actual evaporator delta temperature. Entering – Leaving water temperature
OAT			Actual outside ambient temperature
Signal			Actual input current read on the terminals Setpoint Reset

Provided the unit is set in Cooling mode (Heating mode), the more the ambient temperature drops below (goes beyond) the SROAT, the more the LWT active setpoint (AS) is increased(decreased), until the OAT reaches the MROAT limit.

When the OAT overpasses the MROAT, the active setpoint does not increase(decrease) anymore, and it remains stable to its maximum(minimum) value, i.e. $AS = LWT + MR(-MR)$.

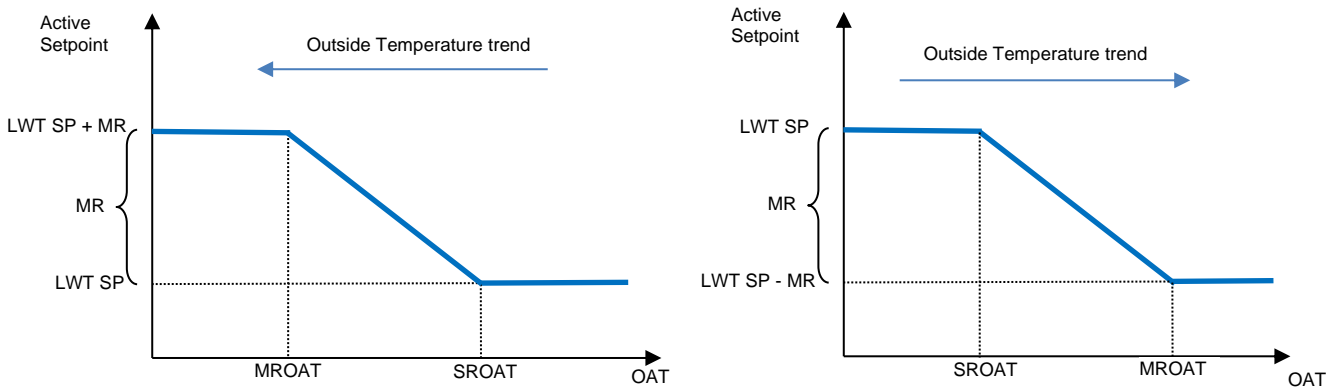

Graph 2 Outside Ambient Temperature vs Active Setpoint - Cooling mode(left)/ Heating mode(right)

4.10.2.2 Setpoint Reset by External 4-20mA signal

When the 4-20mA is selected as Setpoint Reset option, the LWT active setpoint(AS) is calculated applying a correction based on an external 4-20mA signal: 4 mA corresponds to 0°C correction, i.e. $AS = LWT$ setpoint, whereas 20 mA corresponds to a correction of the Max Reset (MR) quantity, i.e. $AS = LWT$ setpoint + MR(-MR) as shown in the following table:

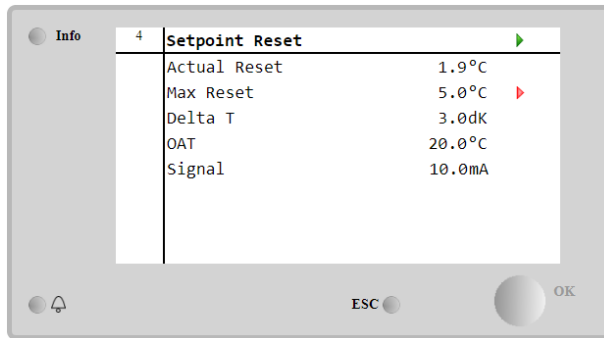

Parameter	Default	Range	Description
Actual Reset			Actual Reset shows which is the correction that will applied to the base setpoint
Max Reset (MR)	5.0°C	0.0°C ÷ 10.0°C	Max Reset setpoint. It represents the maximum temperature variation that the selection of the 4-20mA option can cause on the LWT.
Delta T			Is the actual evaporator delta temperature. Entering – Leaving water temperature
OAT			Actual outside ambient temperature
Signal			Actual input current read on the terminals Setpoint Reset

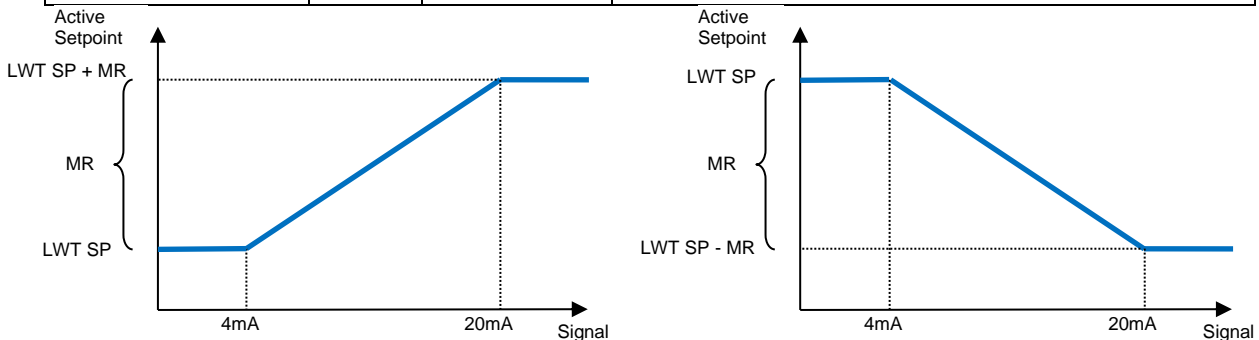

Graph 3 External signal 4-20mA vs Active Setpoint - Cooling mode(left)/ Heating mode(right)

4.10.2.3 Setpoint Reset by DT

When the DT is selected as Setpoint Reset option, the LWT active setpoint(AS) is calculated applying a correction based on the temperature difference ΔT between the leaving water temperature(LWT) and the evaporator entering(returning) water temperature (EWT). When the $|\Delta T|$ becomes smaller than the Start Reset ΔT setpoint(SR ΔT),

the LWT active setpoint is proportionally increased (if Cooling mode set) or decreased (if Heating mode is set) of a maximum value equal to the Max Reset(MR) parameter.

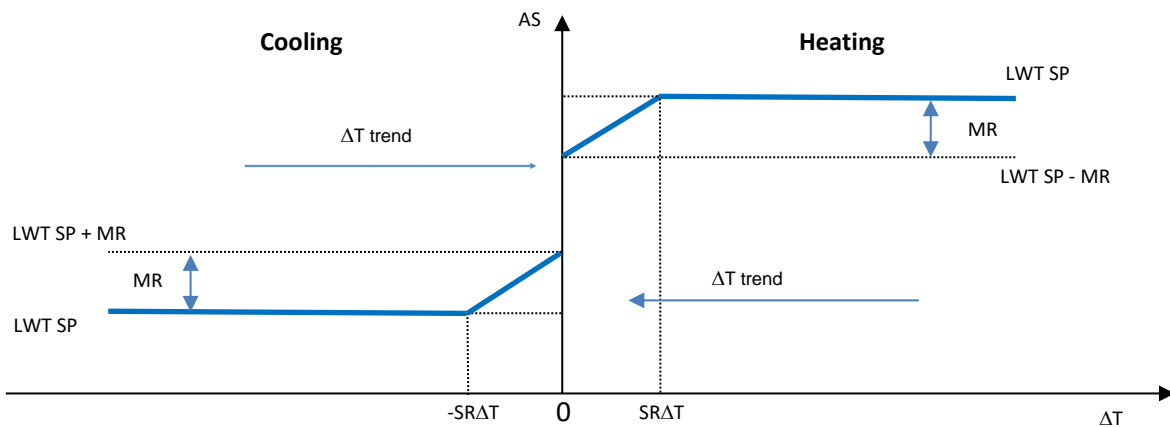
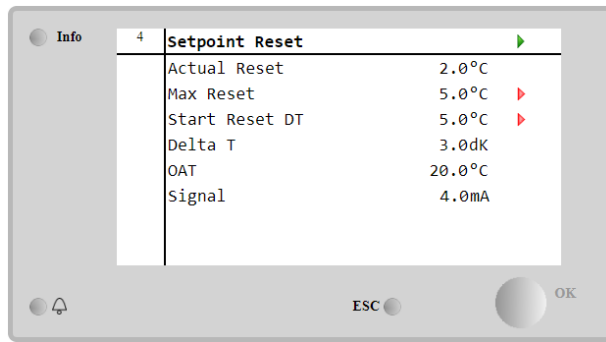

Graph 4 Evap ΔT vs Active Setpoint - Cooling mode(left)/ Heating mode(right)

Parameter	Default	Range		Description
Max Reset (MR)	5.0°C	0.0°C 10.0°C	÷	Max Reset setpoint. It represents the maximum temperature variation that the selection of the EWT option can cause on the LWT.
Max Reset (MR)	5.0°C	0.0°C 10.0°C	÷	Max Reset setpoint. It represents the maximum temperature variation that the selection of the DT option can cause on the LWT.
Start Reset DT (SRΔT)	5.0°C	0.0°C 10.0°C	÷	It represents the “threshold temperature” of the DT to activate the LWT setpoint reset, i.e. the LWT setpoint is overwritten only if the DT reaches/overpasses the SRΔT.
Delta T				Is the actual evaporator delta temperature. Entering – Leaving water temperature
OAT				Actual outside ambient temperature
Signal				Actual input current read on the terminals Setpoint Reset

4.11 Electrical Data

Unit controller returns main electrical values read by the energy meter Nemo D4-L or Nemo D4-Le or NanoH. All data are collected in the menu Electrical Data.

Main Page → View/Set Unit → Electrical Data

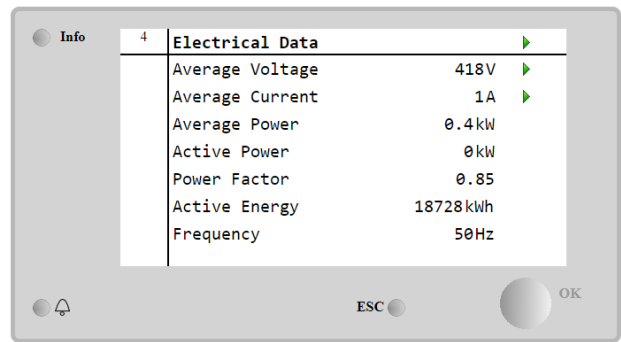
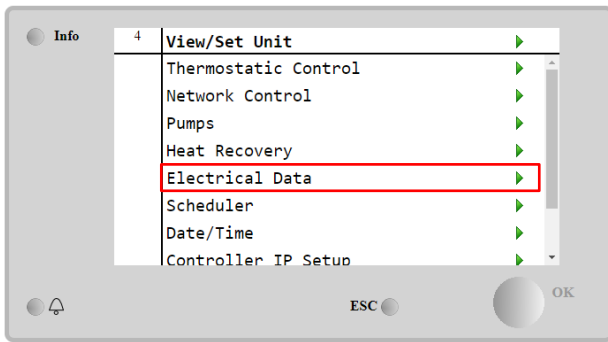

Parameter	Description
Average Voltage	Returns the average of the three chained voltages and links to the Voltage Data page
Average Current	Returns the current average and links to the Current Data page
Average Power	Returns the average power
Active Power	Returns the active power
Power Factor	Returns the power factor
Active Energy	Returns the active energy
Frequency	Returns the active frequency

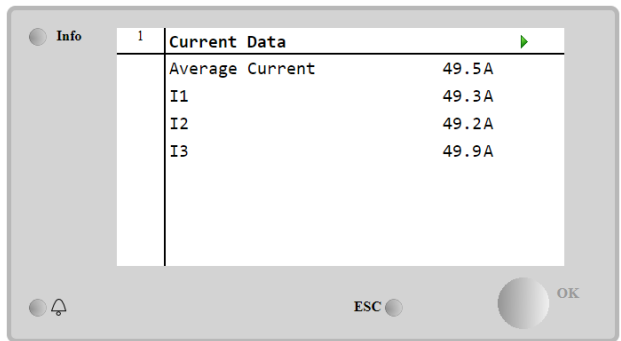
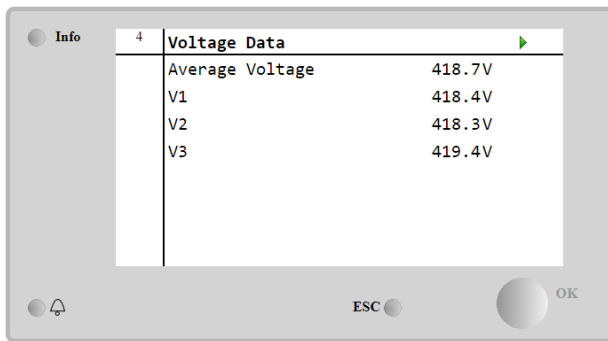

4.12 Controller IP Setup

The Controller IP Setup page is located at the path **Main Menu → View/Set Unit → Controller IP Setup**.

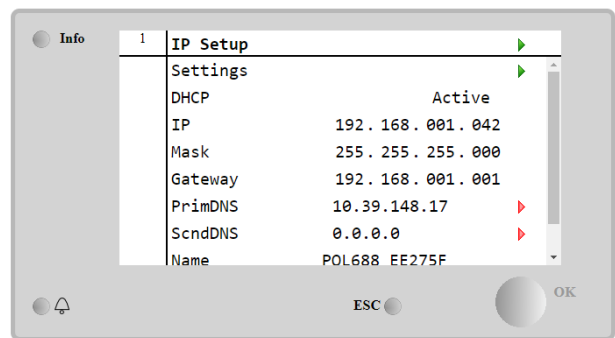
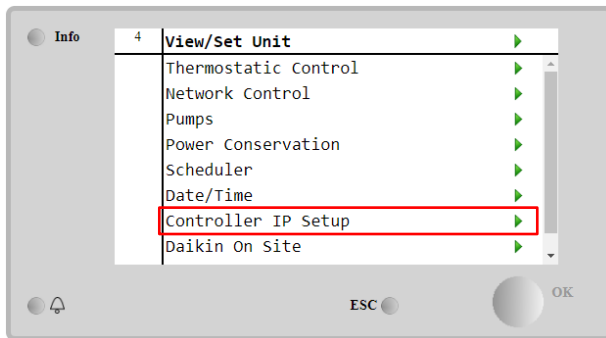

All of the information about current MT4 IP Network settings is reported in this page, as shown in the following table:

Parameter	Range	Description
DHCP	Active	The DHCP option is enabled.
	Passive	The DHCP option is disabled.
IP	xxx.xxx.xxx.xxx	The current IP address
Mask	xxx.xxx.xxx.xxx	The current Subnet Mask address.
Gateway	xxx.xxx.xxx.xxx	The current Gateway address.
PrimDNS	xxx.xxx.xxx.xxx	The current Primary DNS address.
ScndDNS	xxx.xxx.xxx.xxx	The current Secondary DNS address.
Device	POLxxx_xxxxxx	The Host Name of the MT4 controller.
MAC	xx-xx-xx-xx-xx-xx	The MAC address of the MT4 controller.

In order to modify the MT4 IP Network configuration, do the following operations:

- access the **Settings** menu

- set the DHCP option to Passive
- modify the IP, Mask, Gateway, PrimDNS and ScndDNS addresses, if needed, taking care of the current network settings
- set **Apply changes** parameter to **Yes** to save the configuration and restart the MT4 controller.

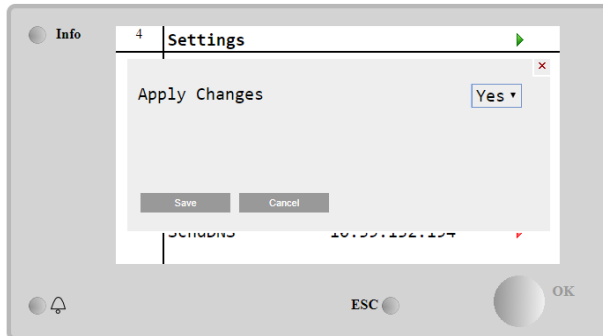
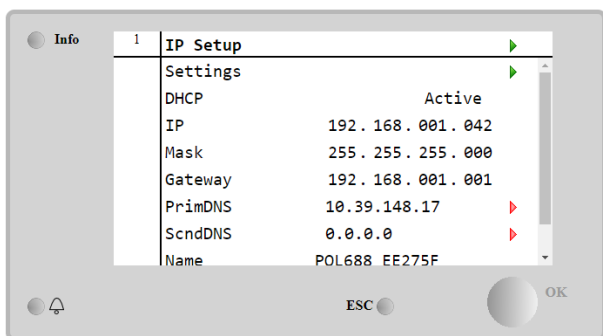

The default internet configuration is:

Parameter	Default Value
IP	192.168.1.42
Mask	255.255.255.0
Gateway	192.168.1.1
PrimDNS	0.0.0.0
ScndDNS	0.0.0.0

Note that if the DHCP is set to On and the MT4 internet configurations shows the following parameter values

Parameter	Value
IP	169.254.252.246
Mask	255.255.0.0
Gateway	0.0.0.0
PrimDNS	0.0.0.0
ScndDNS	0.0.0.0

then an internet connection problem has occurred (probably due to a physical problem, like the Ethernet cable breaking).

4.13 Daikin On Site

The Daikin on Site(DoS) page can be accessed navigating through **Main Menu** → **View/Set Unit** → **Daikin On Site**.

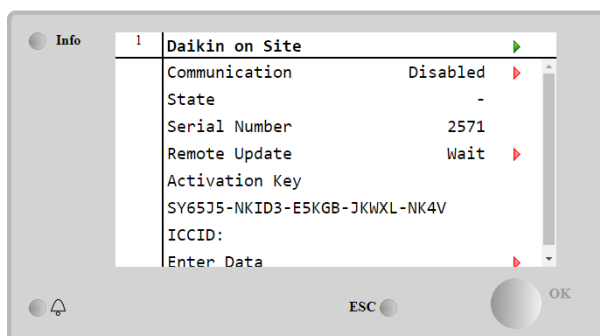
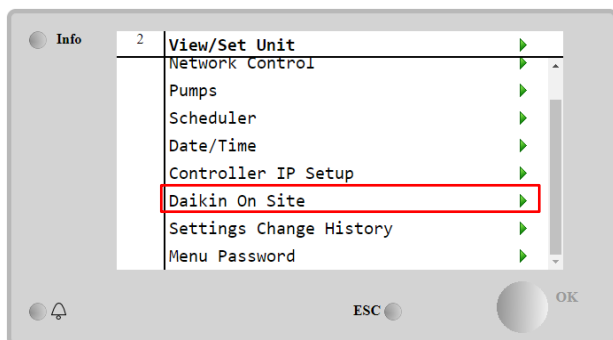

In order to use the DoS utility, the customer has to communicate the **Serial Number** to Daikin company and subscribe to the DoS service. Then, from this page, it is possible to:

- Start/Stop the DoS connectivity
- Check the connection status to DoS service
- Enable/Disable the remote update option

according to the parameters shown into the table below.

Parameter	Range	Description
Comm Start	Disabled	Stop the connection to DoS
	Enabled	Start the connection to DoS
Comm State	-	Connection to DoS is off
	IPerr	Connection to DoS cannot be established
	Connected	Connection to DoS is established and working
Remote Update	Wait	The Remote update is not allowed even the request is started from DOS
	Yes	Enable the Remote update option
	No	Disable the Remote update option

Among all the services provided by DoS, the **Remote Update** option allows to remotely update the software currently running on the PLC controller, avoiding an in-situ intervention of maintenance personnel. To this purpose, just set the Remote Update parameter to **Yes**. Otherwise, keep the parameter set to **wait** or **Disable**.



For a successful remote software update, local service support is required, and a strong internet connection must be guaranteed.

In the unlikely event of PLC replacement, the DoS connectivity can be switched from the old PLC to the new one just communicating the current **Activation Key** to Daikin company.

4.14 Heat Recovery

The unit controller can handle a total or partial heat recovery option.

Some settings need to be properly set in order to match the specific plant requirements, going in **Main PageàView/Set UnitàHeat Recovery**.

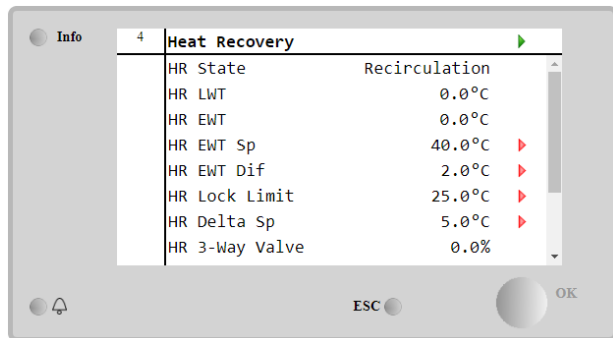
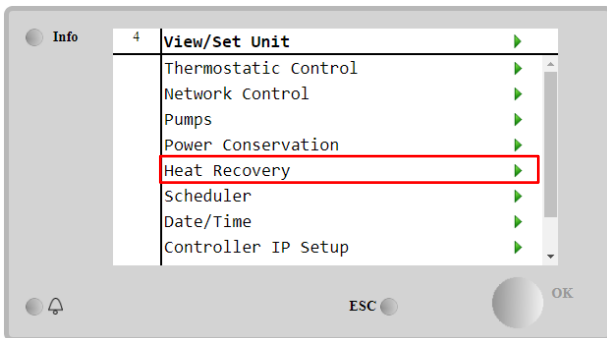

Parameter	Range	Description
HR State	Off	Heat recovery is disabled
	Recirculation	Heat recovery pump is running, but chiller fan is not regulating the heat recovery water temperature
	Regulation	Heat recovery pump is running and chiller fans are regulating the heat recovery water temperature
HR LWT		Heat recovery leaving water temperature
HR EWT		Heat recovery entering water temperature
HR EWT Sp		Heat recovery entering water temperature setpoint value
HR EWT Dif		Heat recovery
HR Lock Limit		
HR Delta Sp		
HR 3-way Valve		Heat recovery 3-way valve opening percentage
HR Pumps		Heat recovery pump state
HR Pump Hours		Heat recovery pump running hours
HR C1 Enable		Heat recovery enable on circuit 1
HR C2 Enable		Heat recovery enable on circuit 2

In case unit control source is "Network", to enable heat recovery functionality following conditions must be true:

- Enable the "HR C1 or C2 Enable" parameter in the Heat recovery page.
- Enable BMS register: Heat Recovery - Enable Setpoint

4.15 Rapid Restart

This chiller can activate a Rapid Restart (optional) sequence in reaction to a power failure. This option allows the unit to restore the load it had before the power failure in less time, reducing the standard cycle timer.

In order to Enable the Rapid Restart functionality, the customer must set to **Yes** the "Rapid Restart" parameter in the Rapid Restart page.

The feature is configured in the factory.

The 'Rapid Restart' page can be accessed navigating through **Main Menu** → **View/Set Unit** → **Rapid Restart**.

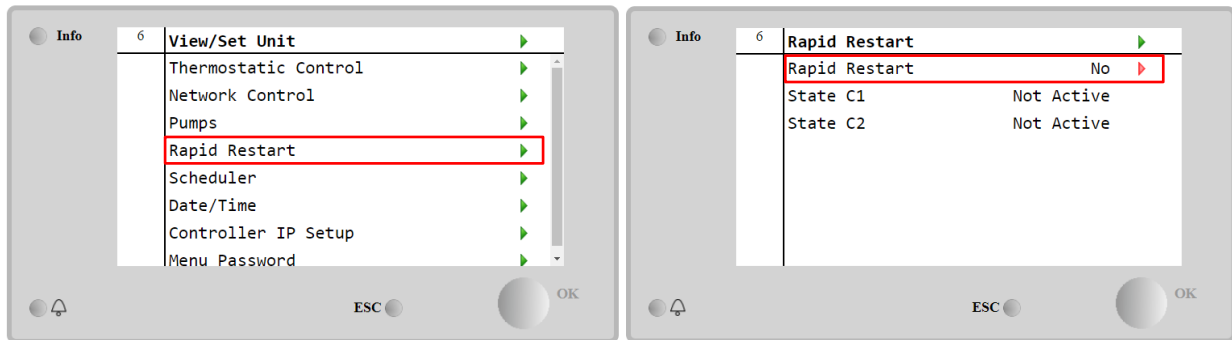

The "State C1/2" represents the actual state of the Rapid Restart procedure for each circuit.

Rapid restart is activated under the following conditions:

- The power failure exists for up to 180 seconds
- The unit and circuit switches are ON
- No unit or circuit alarms exist
- The unit has been running in the normal Run state
- The BMS Circuit Mode setpoint is set to Auto when the control source is Network
- The ELWT isn't lower than the "ELWT Setpoint + StgUpDT"
- The ELWT is greater than the "ELWT Setpoint + NomEvapDT*Par_RpdRst", where Par_RpdRst is a parameter that can be modified

If the power failure is more than 180 seconds, the unit will start based on the standard cycle timer without Rapid Restart. After the power restart, the timers that are used during the Rapid Restart procedure are:

Parameter	Timer
Pump On	14s
1st Compr On	30s
Full Load (6 Compr)	180s

4.16 FreeCooling Hydronic (Cooling Only)

Freecooling is started when the outside air temperature is lower than the entering water temperature by a predetermined freecooling delta T. Full freecooling will only be possible below a design temperature however logic will try to get the most out of the air temperature to optimize the overall performance of the chiller.

When freecooling is started, the freecooling valve is opened to let water pass through the freecooling coils and get cooled before entering the evaporator heat exchanger and go to the plant as leaving water temperature. Fans are started and then controlled to maintain the leaving water temperature to the active setpoint.

If the outside air temperature is not low enough to permit full freecooling and satisfy the plant load, the unit may start the mixed mode. In fact, if, with the fan at full speed, the leaving water temperature does not reach the active setpoint and remains above the Stage Up Temperature with a low slope, after a predetermined time a circuit can be started in mechanical mode. In this case, the fan speed will be adapted to control the minimum pressure ratio needed to guarantee the correct lubrication of compressors.

The FreeCooling page can be accessed navigating through **Main Menu** → **View/Set Unit** → **Hydronic Freecooling**.

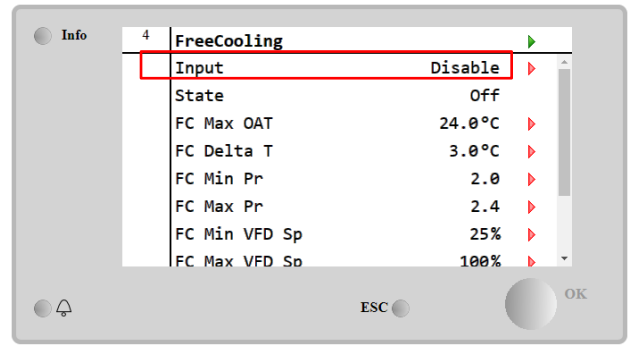
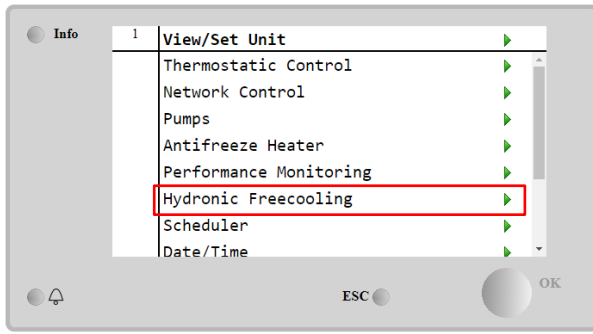

Parameter	Range	Description
Input	Disable	The Option is not enabled with all the inputs necessary
	Enable	The Option is correctly enabled
Remote Input	Disable	The Option is not enabled with all the inputs necessary via BMS
	Enable	The Option is correctly enabled via BMS
State	Off	Unit's State in Off
	Free Cooling	Unit State in Free Cooling mode, both Circuits run in Freecooling
	MIXed	Unit State in Mixed mode, one Circuit run in Freecooling and the second run in Mechanical mode
	Mechanical	Unit State in Mechanical mode, both Circuits run in Mechanical
FC Max Oat	10-30 °C	Maximum value for air temperature to enable the freecooling. Above this value the freecooling mode cannot be used.
FC Delta T	0-10 °C	Difference between entering water temperature and air temperature to enable the freecooling operations.
FC Min Pr	1.4-3	To adjust minimum pressure ratio for fans control.
FC Max Pr	1.4-3	To adjust maximum pressure ratio for fans control.
FC Min VFD Sp	5-50 %	To adjust minimum fan speed in freecooling mode.
FC Max VFD Sp	70-100 %	To adjust maximum fan speed in freecooling mode.

In order to enable the Freecooling functionality, the customer must set to **Enable** the "Input" parameter in the Freecooling page.

In case unit control source is "Network", to enable freecooling functionalities following conditions must be true:

- 1) Enable the "Input" parameter in the Freecooling page.
- 2) Enable BMS register: Freecooling - Enable Setpoint

4.16.1 Glycol Free Freecooling

The Glycol Free option in Freecooling condition is characterized with the presence of an intermediate water/water heat exchanger connected to a water loop with glycol. The main water loop will be glycol free to simplify the waste water management. This kind of chillers require an additional pump to circulate the glycol in the freecooling closed loop which is linked to the main loop through an intermediate heat exchanger. This pump will be always active when freecooling is active, in case in of freezing in the closed loop or OAT Lockout.

So, in case of glycol free option, there are some additional datapoints respect the hydronic freecooling:

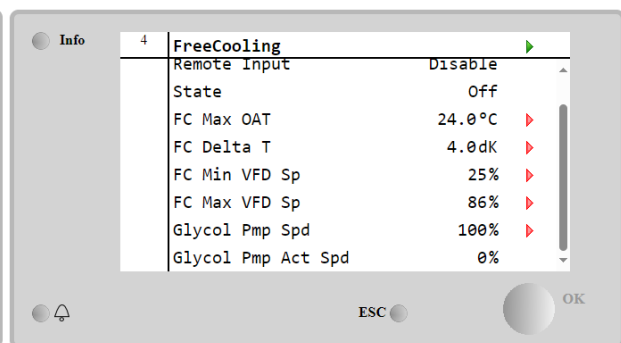
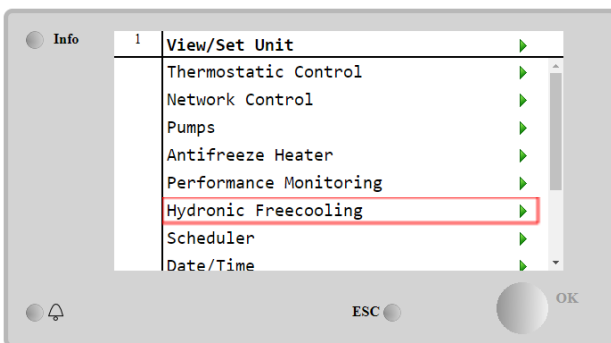

Parameter	Range	Description
Glycol Pmp Spd	0-100 %	Select nominal glycol pump's speed
Glycol Pmp Act Spd	0-100 %	Show the actual velocity of the glycol pump
Glycol DT ofs	0-15 °C	Select the additional offset to the Fc Delta T to enable the freecooling operations (during the transition mechanical Fc to mixed Fc)

4.17 Antifreeze Heater

The Antifreeze Heater page can be accessed navigating through **Main Menu → View/Set Unit → Antifreeze Heater**

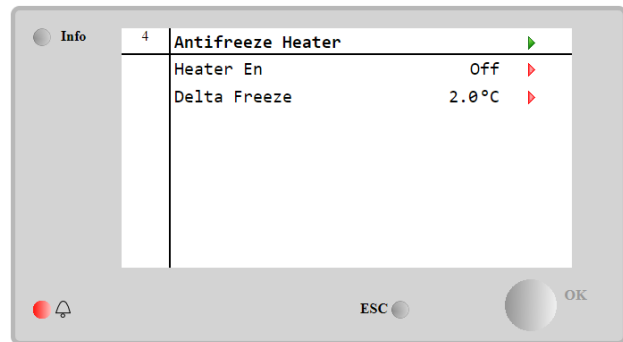
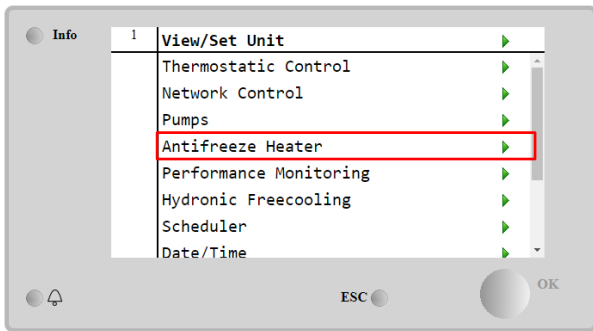

Parameter	Range	Description
Heater En	Off	The Option is not enabled.
	On	The Option is correctly enabled
Delta Freeze	0 ÷ +5 °C	Difference between entering or leaving water temperature and freezing setpoint to enable the antifreeze heater.

In order Enable the Antifreeze Heater functionality, the customer must set to **On** the “Heater En” parameter in the Antifreeze Heater page.

4.18 Glycol Tank Heater

The Glycol Tank Heater page can be accessed navigating through **Main Menu → View/Set Unit → Glycol Tank Heater**

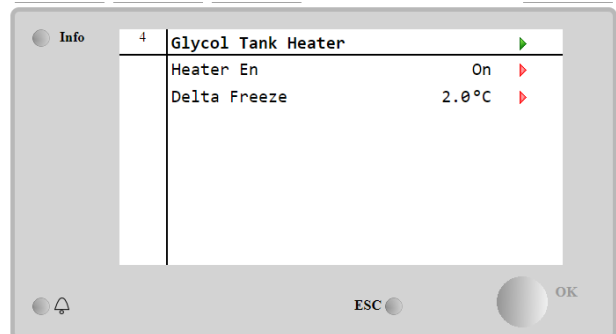
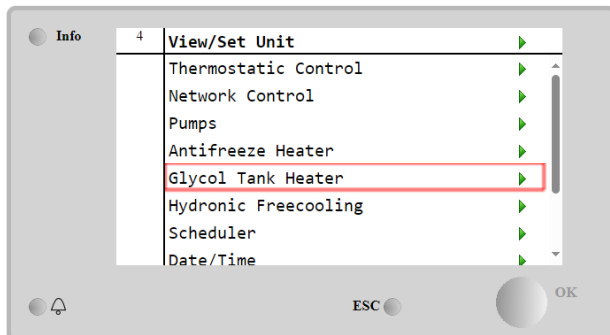

Parameter	Range	Description
Heater En	Off	The Option is not enabled.
	On	The Option is correctly enabled
Delta Freeze	-5 ÷ +5 °C	Difference between glycol entering or glycol leaving water temperature and glycol tank freezing setpoint to enable the glycol tank heater.

In order Enable the Glycol Tank Heater functionality, the customer must set to **On** the “Heater En” parameter in the Glycol Tank Heater page.

4.19 Software Options

For the EWYT model, the possibility to employ a set of software options has been added to the functionality of the chiller, in according with the new Microtech 4 installed on the Unit. The Software Options do not require any additional hardware and regard communication channels and the new energy functionalities.

During the commissioning the machine is delivered with the Option Set chosen by the customer; the Password inserted is permanent and depends on the Serial Machine Number and the Option Set selected.

In order to check the current Option Set:

Main Menu→Commission Unit → Configuration → Software Options.

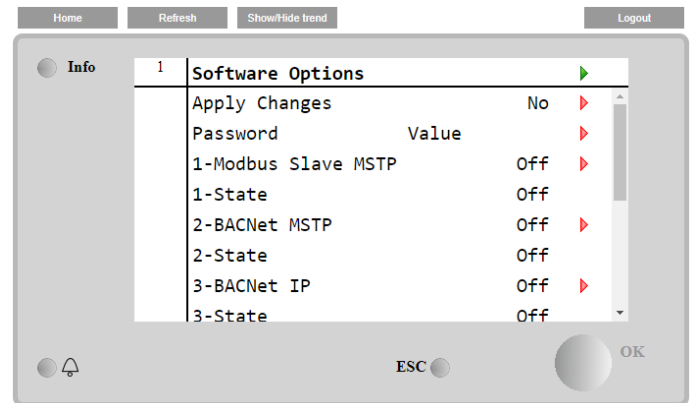
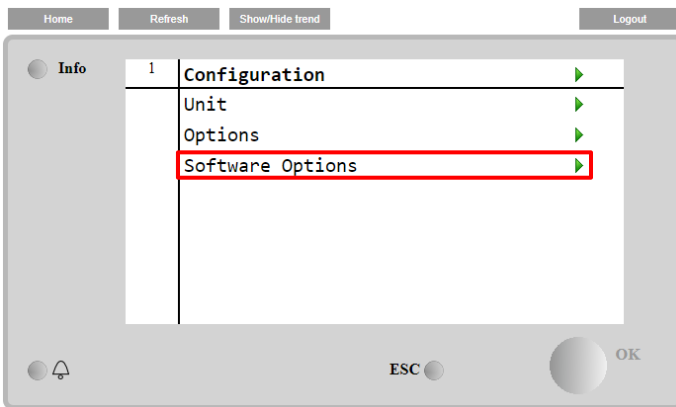

Parameter	Description
Password	Writable by Interface/Web Interface
Option Name	Option Name
option Status	Option is activated. Option is not activated

The Current Password inserted activates the selected options.

4.19.1 Changing the Password for buying new Software Options

The Option Set and the Password are updated in the Factory. If the customer wants to change its Option Set, he needs to contact the Daikin Personnel and asks for a new password.

As soon as the new password is communicated, the follow steps allow the customer to change the Option Set by himself:

1. Wait for the circuits are both OFF, then, from the Main Page, Main Menu→Unit Enable→Unit→Disable
2. Go to Main Menu→Commission Unit→Configuration→Software Options
3. Select the Options to Activate
4. Insert the Password
5. Wait for the States of the selected options going to On
6. Apply Changes→Yes (it will reboot the controller)

The Password is changeable only if the machine is working in safe conditions: both the circuits are in the State Off.

4.19.2 Inserting the Password in a Spare Controller

If the Controller is broken and/or it needs to be replaced for any reason, the customer needs to configure the Option Set with a new Password.

If this replacement is scheduled, the customer can ask to Daikin Personnel for a new Password and repeat the steps in chapter 4.18.1.

If there is no enough time to ask for a Password to Daikin Personnel (ex. an expected failure of the controller), a set of Free Limited Password is provided, in order not to interrupt the machine's working.

These Passwords are free and visualized in:

Main Menu → Commission Unit → Configuration → Software Options → Temporary Passwords

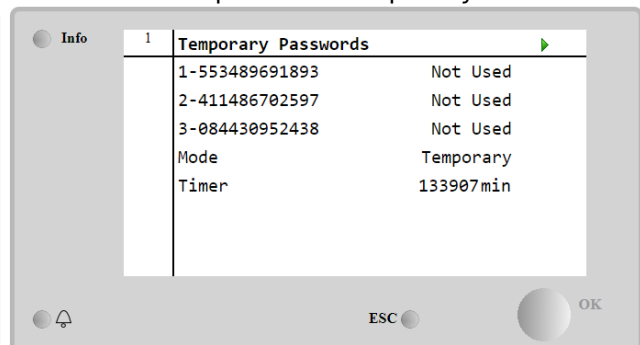
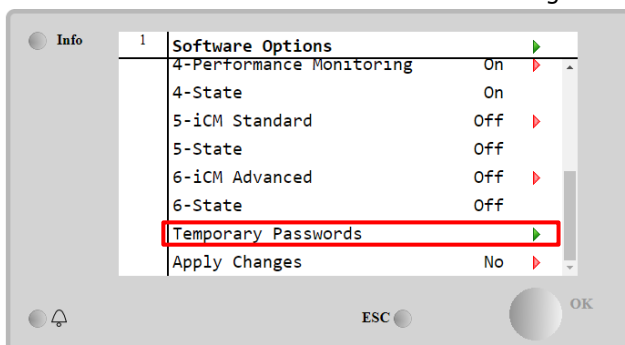

Their Use is limited up to three months:

- 553489691893 – 3 Months Duration
- 411486702597 – 1 Month Duration
- 084430952438 – 1 Month Duration

It gives the customer the time enough to contact Daikin Service and insert a new unlimited password.

Parameter	Specific Status	Description
553489691893		Activate the Option Set for 3 Months.
411486702597		Activate the Option Set for 1 Month.
084430952438		Activate the Option Set for 1 Month.
Mode	Permanent	A permanent Password is inserted. Option set can be used for unlimited time.
Temporary		A temporary Password is inserted. Option set can be used depending on the password inserted.
Timer		Last duration of the Option Set activated. Enabled only if the mode is Temporary

The Password is changeable only if the machine is working in safe conditions: both the circuits are in the State Off.

4.19.3 Modbus MSTP Software Option

When the software option "Modbus MSTP" is activated and the controller is restarted, the communication protocol settings page can be accessed via the path:

Main Menu→Commission Unit→SW Modbus MSTP

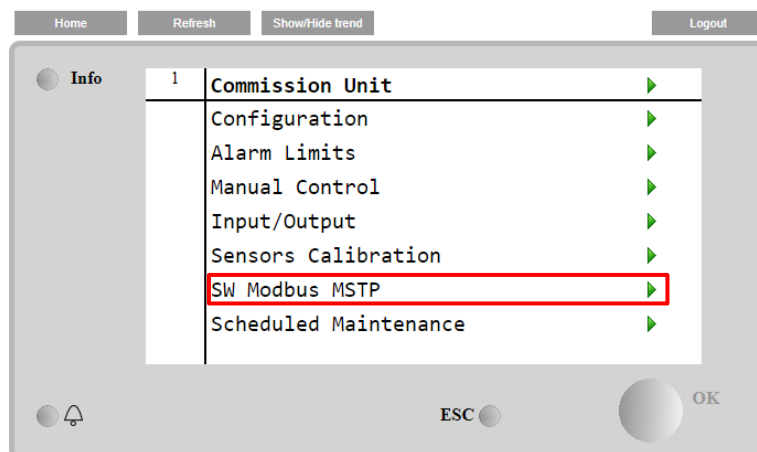

The values that can be set are the same as those found on the Modbus MSTP option page with the relative driver, and depend on the specific system where the unit is installed.

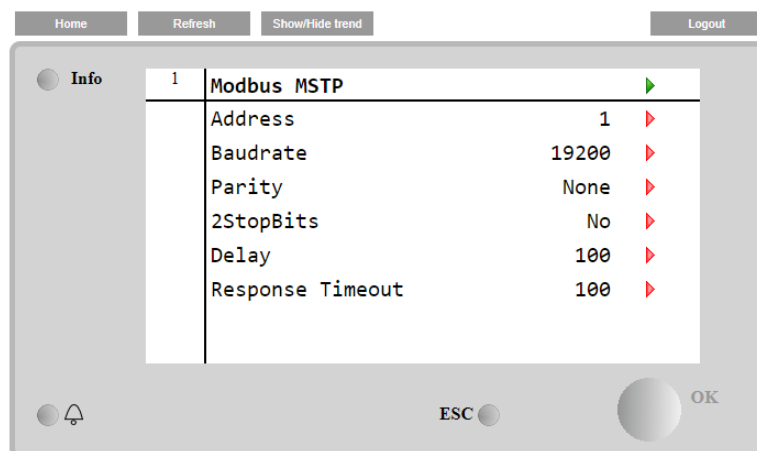

To establish the connection, the RS485 port to use is the one on the T14 terminal of the MT4 controller.

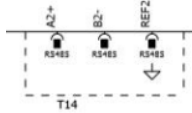

4.19.4 BACNET MSTP

When the software option "BACNet MSTP" is activated and the controller is restarted, the communication protocol settings page can be accessed via the path:

Main Menu→Commission Unit→SW BACNet MSTP

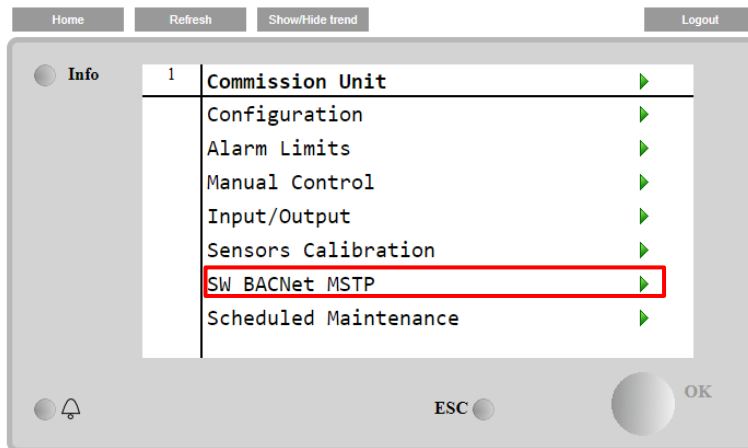

The values that can be set are the same as those found on the BACNet MSTP option page with the relative driver, and depend on the specific system where the unit is installed.

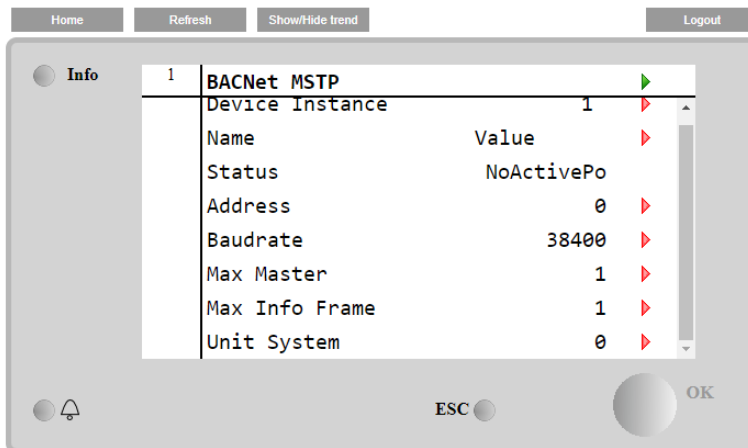

To establish the connection, the RS485 port to use is the one on the T14 terminal of the MT4 controller.

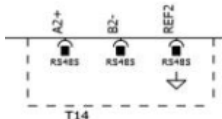

4.19.5 BACNET IP

When the software option "BACNet IP" is activated and the controller is restarted, the communication protocol settings page can be accessed via the path:

Main Menu→Commission Unit→SW BACNet IP

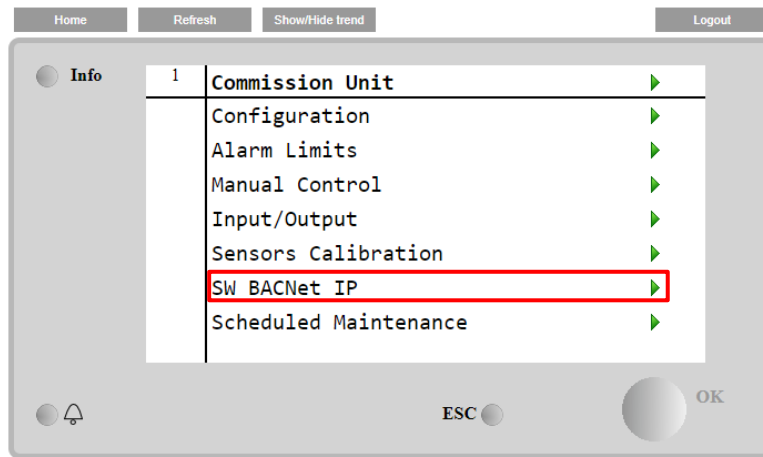

The values that can be set are the same as those found on the BACNet MSTP option page with the relative driver, and depend on the specific system where the unit is installed.

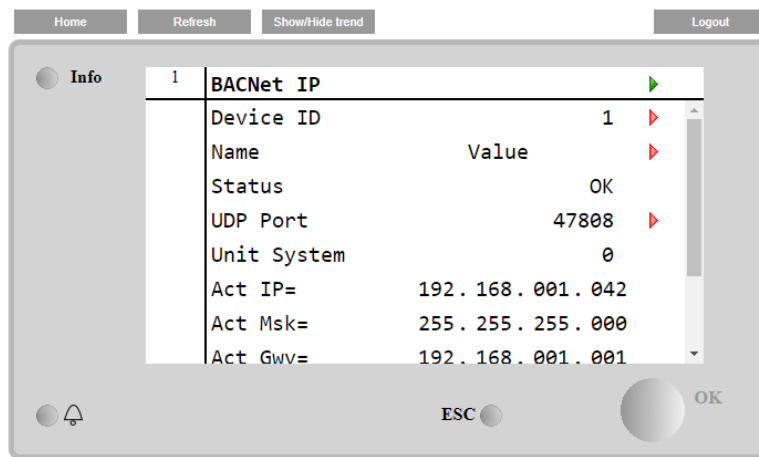

The port for LAN connection to be used for BACNet IP communication is the T-IP Ethernet port, the same one used for remote control of the controller on the PC.

4.19.6 PERFORMANCE MONITORING

The Performance Monitoring is a software option not requiring any additional hardware. It can be activated in order to achieve an estimation of the instantaneous performances of the chiller in terms of:

- Cooling Capacity or Heating Capacity
- Power Input
- EER-COP in Heat mode

An integrated estimation of these quantities is provided. Go to the page:

Main Menu → View / Set Unit → Performance Monitoring

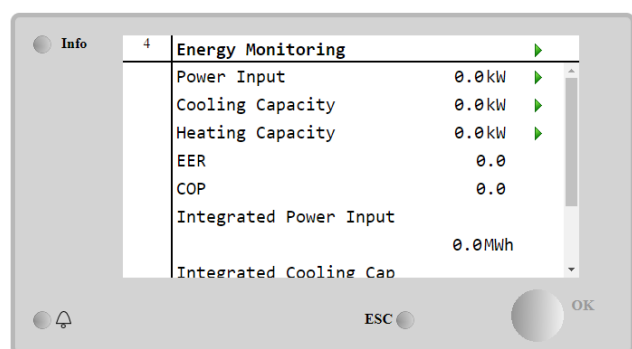
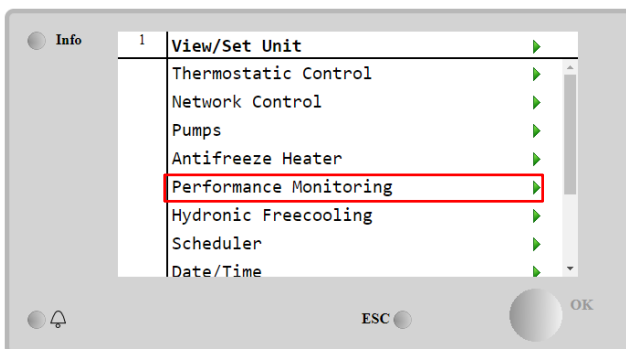

Info 4 **Power Input** ▶

Circuit 1	0.0kW
Circuit 2	0.0kW
PI Pump	0.0kW

ESC OK

Info 4 **Cooling Capacity** ▶

Circuit 1	0.0kW
Circuit 2	0.0kW

ESC OK

Info 4 **Heating Capacity** ▶

Circuit 1	0.0kW
Circuit 2	0.0kW

ESC OK

5 ALARMS AND TROUBLESHOOTING

The UC protects the unit and the components from operating in abnormal conditions. Protections can be divided in preventions and alarms. Alarms can then be divided in pump-down and rapid stop alarms. Pump-down alarms are activated when the system or sub-system can perform a normal shutdown in spite of the abnormal running conditions. Rapid stop alarms are activated when the abnormal running conditions require an immediate stop of the whole system or sub-system to prevent potential damages.

The UC displays the active alarms in a dedicated page and keep an history of the last 50 entries divided between alarms and acknowledges occurred. Time and date for each alarm event and of each alarm acknowledge are stored.

The UC also stores alarm snapshot of each alarm occurred. Each item contains a snapshot of the running conditions right before the alarm has occurred. Different sets of snapshots are programmed corresponding to unit alarms and circuit alarms holding different information to help the failure diagnosis.

In the following sections it will also be indicated how each alarm can be cleared between local HMI, Network (by any of the high-level interfaces Modbus, Bacnet or Lon) or if the specific alarm will clear automatically.

5.1 Unit Alerts

All alarms reported in this section does not produce a unit stop, but only a visual information and an item in the alarm log.

5.1.1 BadLWTRreset - Bad Leaving Water Temperature Reset Input

This alarm is generated when the Setpoint Reset option has been enabled and the input to the controller is out of the admitted range.

Symptom	Cause	Solution
Unit status is Run. Bell icon is moving on controller's display. LWT Reset function cannot be used. String in the alarm list: BadLWTRreset String in the alarm log: ± BadLWTRreset String in the alarm snapshot BadLWTRreset	LWT reset input signal is out of range. For this warning out of range is considered to be a signal less than 3mA or more than 21mA.	Check for values of input signal to the unit controller. It has to be in the allowed mA range.
		Check for electrical shielding of wirings.
		Check for any wrong electrical wiring.
Reset		
Local HMI	<input type="checkbox"/>	
Network	<input type="checkbox"/>	
Auto	<input checked="" type="checkbox"/>	

5.1.2 EnergyMeterComm - Energy Meter Communication Fail

This alarm is generated in case of communication problems with the energy meter.

Symptom	Cause	Solution
Bell icon is moving on controller's display. String in the alarm list: EnergyMeterComm String in the alarm log: ± EnergyMtrComm String in the alarm snapshot EnergyMtrComm	Module has no power supply	Refer to the datasheet of the specific component to see if it is correctly powered.
	Wrong cabling with the Unit Controller	Check if the polarity of the connections is respected.
	Modbus parameters not properly set	Referring to the installation drive of the specific component to see if the modbus parameters are set correctly
	Module is broken	Check if the HMI is visible in the controller display and if the power supply is present
Reset		
Local HMI	<input type="checkbox"/>	
Network	<input type="checkbox"/>	
Auto	<input checked="" type="checkbox"/>	

5.1.3 EvapPump1Fault - Evaporator Pump #1 Failure

This alarm is generated if the pump is started but the flow switch is not able to close within the recirculate time. This can be a temporary condition or may be due to a broken flowswitch, the activation of circuit breakers, fuses or to a pump breakdown.

Symptom	Cause	Solution
Unit could be ON. Bell icon is moving on controller's display.	Pump #1 may not be operating.	Check for problem in electrical wiring of the pump #1.
		Check that electrical breaker of pump #1 is tripped.

Backup pump is used or stop of all circuits in case of pump #2 failure. String in the alarm list: EvapPump1Fault String in the alarm log: ± EvapPump1Fault String in the alarm snapshot EvapPump1Fault		If fuses are used to protect the pump, check the integrity of fuses.
		Check for problem in wiring connection between pump starter and unit controller.
		Check the water pump filter and the water circuit for obstructions.
	Flow Switch doesn't operate properly	Check flow switch connection and calibration.
Reset		
Local HMI	<input checked="" type="checkbox"/>	
Network	<input checked="" type="checkbox"/>	
Auto	<input type="checkbox"/>	

5.1.4 BadDemandLimit - Bad Demand Limit Input

This alarm is generated when the Demand Limit option has been enabled and the input to the controller is out of the admitted range.

Symptom	Cause	Solution
Unit status is Run. Bell icon is moving on controller's display. Demand Limit function cannot be used. String in the alarm list: BadDemandLimit String in the alarm log: ±BadDemandLimit String in the alarm snapshot BadDemandLimit	Demand limit input out of range. For this warning out of range is considered to be a signal less than 3mA or more than 21mA.	Check for values of input signal to the unit controller. It has to be in the allowed mA range.
		Check for electrical shielding of wirings.
		Check for any wrong electrical wiring
Reset		Notes
Local HMI	<input type="checkbox"/>	Automatically clears when the signal returns in the allowed range.
Network	<input type="checkbox"/>	
Auto	<input checked="" type="checkbox"/>	

5.1.5 EvapPump2Fault - Evaporator Pump #2 Failure

This alarm is generated if the pump is started but the flow switch is not able to close within the recirculate time. This can be a temporary condition or may be due to a broken flowswitch, the activation of circuit breakers, fuses or to a pump breakdown.

Symptom	Cause	Solution
Unit could be ON. Bell icon is moving on controller's display. Backup pump is used or stop of all circuits in case of pump #1 failure. String in the alarm list: EvapPump2Fault String in the alarm log: ± EvapPump2Fault String in the alarm snapshot EvapPump2Fault	Pump #2 may not be operating.	Check for problem in electrical wiring of the pump #2.
		Check that electrical breaker of pump #2 is tripped.
		If fuses are used to protect the pump, check the integrity of fuses.
		Check for problem in wiring connection between pump starter and unit controller.
		Flow Switch doesn't operate properly
		Check flow switch connection and calibration.
Reset		
Local HMI	<input checked="" type="checkbox"/>	
Network	<input checked="" type="checkbox"/>	
Auto - Reset	<input type="checkbox"/>	

5.1.6 SwitchBoxTHi - Switch box temperature High

This alarm indicates that the temperature at the switch box exceeded a maximum limit which may cause damages to the switch box.

Symptom	Cause	Solution
Unit status is On Bell icon is moving on controller's display. Bell icon is moving on controller's display.	Cooling fan of the switch box doesn't operate properly.	Check for proper operation of the cooling fan.
	Fan filter clogged causes reduction of air mass flow rate.	Remove any obstacle. Clean the fan filter using soft brush and blower.

String in the alarm list: Swi tchBoxTHi	The OAT is greater than the switch box sizing values.	Check if the chiller works beyond the design limits.
String in the alarm log: ± Swi tchBoxTHi String in the alarm snapshot Swi tchBoxTHi	Switch Box temperature sensor could not operate properly.	Check for proper operation of the switch box temperature sensor, if available.
Reset		Notes
Local HMI Network Auto	<input type="checkbox"/> <input type="checkbox"/> <input checked="" type="checkbox"/>	

5.1.7 SwitchBoxTSen - Switch Box Temperature sensor fault

This alarm is generated any time that the input resistance is out of an acceptable range.

Symptom	Cause	Solution
Unit status is On Bell icon is moving on controller's display. Bell icon is moving on controller's display. String in the alarm list: Swi tchBoxTempSen String in the alarm log: ± Swi tchBoxTempSen String in the alarm snapshot Swi tchBoxTempSen	Sensor is broken.	Check for sensor integrity according table and allowed kOhm (kΩ) range. Check for sensor phisycal integrity.
	Sensor is shorted.	Check if sensor is shorted with a resistance measurement.
	Sensor is not properly connected (open).	Check for absence of water or humidity on electrical contacts.
		Check for correct plug-in of the electrical connectors.
		Check for correct sensors wiring also according electrical scheme.
		Check for correct installation of the sensor in the switch box.
Reset		Notes
Local HMI Network Auto	<input checked="" type="checkbox"/> <input checked="" type="checkbox"/> <input type="checkbox"/>	

5.1.8 ExternalEvent - External Event

This alarm indicates that a device, whose operation is linked with this machine, is reporting a problem on the dedicated input.

Symptom	Cause	Solution
Unit status is Run. Bell icon is moving on controller's display. String in the alarm list: External Event String in the alarm log: ±ExternalEvent String in the alarm snapshot ExternalEvent	There is an external event that has caused the opening, for at least 5 seconds, of the digital input on the controller board.	Check causes of the external event or alarm.
		Check electrical wiring from unit controller to the external equipment in case of any external events or alarms have been occurred.
Reset		
Local HMI Network Auto	<input type="checkbox"/> <input type="checkbox"/> <input checked="" type="checkbox"/>	

5.1.9 HeatRec EntWTempSen - Heat Recovery Entering Water Temperature sensor fault

This alarm is generated any time that the input resistance is out of an acceptable range.

Symptom	Cause	Solution
Heat Recovery is Off Bell icon is moving on controller's display. String in the alarm list: HeatRec EntWTempSen String in the alarm log: ± HeatRec EntWTempSen String in the alarm snapshot HeatRec EntWTempSen	Sensor is broken.	Check for sensor integrity according table and allowed kOhm (kΩ) range. Check for sensor phisycal integrity.
	Sensor is shorted.	Check if sensor is shorted with a resistance measurement.
	Sensor is not properly connected (open).	Check for absence of water or humidity on electrical contacts.
		Check for correct plug-in of the electrical connectors.
		Check for correct sensors wiring also according electrical scheme.

		Check for correct installation of the sensor on refrigerant circuit pipe.
Reset		
Local HMI	<input checked="" type="checkbox"/>	
Network	<input checked="" type="checkbox"/>	
Auto	<input checked="" type="checkbox"/>	

5.1.10 HeatRec LvgWTempSen - Heat Recovery Leaving Water Temperature sensor fault

This alarm is generated any time that the input resistance is out of an acceptable range.

Symptom	Cause	Solution
Heat Recovery is Off Bell icon is moving on controller's display. String in the alarm list: HeatRec LvgWTempSen String in the alarm log: ± HeatRec LvgWTempSen String in the alarm snapshot HeatRec LvgWTempSen	Sensor is broken.	Check for sensor integrity according table and allowed kOhm (kΩ) range. Check for sensor phisycal integrity.
	Sensor is shorted.	Check if sensor is shorted with a resistance measurement.
	Sensor is not properly connected (open).	Check for absence of water or humidity on electrical contacts.
		Check for correct plug-in of the electrical connectors.
		Check for correct sensors wiring also according electrical scheme.
		Check for correct installation of the sensor on refrigerant circuit pipe.
Reset		
Local HMI	<input checked="" type="checkbox"/>	
Network	<input checked="" type="checkbox"/>	
Auto	<input checked="" type="checkbox"/>	

5.1.11 HeatRec FreezeAlm - Heat Recovery Water Freeze Protect alarm

This alarm is generated to indicate that the heat recovery water temperature (entering or leaving) has dropped below a safety limit. Control tries to protect the heat exchanger starting the pump and letting the water circulate.

Symptom	Cause	Solution
Unit status is Off. All circuits are stopped immediately. Bell icon is moving on controller's display. String in the alarm list: HeatRec FreezeAlm String in the alarm log: ± HeatRec FreezeAlm String in the alarm snapshot HeatRec FreezeAlm	Water flow too low.	Increase the water flow.
	Inlet temperature to the heat recovery is too low.	Increase the inlet water temperature.
	Sensors readings (entering or leaving) are not properly calibrated	Check the water temperatures with a proper instrument and adjust the offsets
	Wrong Freeze limit setpoint	The freeze limit has not been changed as a function of glycol percentage
Reset		
Local HMI	<input checked="" type="checkbox"/>	
Network	<input checked="" type="checkbox"/>	
Auto	<input type="checkbox"/>	

5.1.12 Option1BoardCommFail – Optional board 1 communication fail

This alarm is generated in case of communication problems with the AC module.

Symptom	Cause	Solution
Unit status is Off. All circuits are stopped immediately. Bell icon is moving on controller's display. String in the alarm list: Option1BoardCommFail String in the alarm log: ± Option1BoardCommFail String in the alarm snapshot Option1BoardCommFail	Module has no power supply	Check the power supply from the connector on the side of the module. Check if LEDs are both green.
		Check if the connector on the side is tightly inserted in the module
	Led Off	Check if power supply is ok but LEDs are both off. In this case replace the module
	BUS or BSP Led are red	Check if module's address is correct referring to the wiring diagram. If BSP LED is solid red replace the module.

		BSP error.
Reset		
Local HMI	<input checked="" type="checkbox"/>	
Network	<input checked="" type="checkbox"/>	
Auto	<input type="checkbox"/>	

5.1.13 UnitOff DLTModuleCommFail – DLT Module Communication Error

This alarm is generated in case of communication problems with the AC module.

Symptom	Cause	Solution
Unit status is Off. All circuits are stopped immediately. Bell icon is moving on controller's display. String in the alarm list: UnitOff DLTModuleCommFail String in the alarm log: ± UnitOff DLTModuleCommFail String in the alarm snapshot UnitOff DLTModuleCommFail	Module has no power supply	Check the power supply from the connector on the side of the module. Check if LEDs are both green. Check if the connector on the side is tightly inserted in the module
	Led Off	Check if power supply is ok but LEDs are both off. In this case replace the module
	BUS or BSP Led are red	Check if module's address is correct referring to the wiring diagram. If BSP LED is solid red replace the module. BSP error.
Reset		
Local HMI	<input checked="" type="checkbox"/>	
Network	<input checked="" type="checkbox"/>	
Auto	<input type="checkbox"/>	

5.1.14 EvapPDSen – Evaporator Pressure Drop sensor fault

This alarm indicates that the evaporator pressure drop transducer is not operating properly. This transducer is used only with Pump Control VPF.

Symptom	Cause	Solution
Pump speed is set with Backup value. Bell icon is moving on controller's display. String in the alarm list: EvapPDSen String in the alarm log: ± EvapPDSen String in the alarm snapshot EvapPDSen	Sensor is broken.	Check for sensor integrity according table and allowed kOhm (kΩ) range. Check for sensor physical integrity.
	Sensor is shorted.	Check if sensor is shorted with a resistance measurement.
	Sensor is not properly connected (open).	Check for absence of water or humidity on electrical contacts. Check for correct plug-in of the electrical connectors. Check for correct sensors wiring also according electrical scheme. Check for correct installation of the sensor on refrigerant circuit pipe.
Reset		
Local HMI	<input type="checkbox"/>	
Network	<input type="checkbox"/>	
Auto	<input checked="" type="checkbox"/>	

5.1.15 LoadPDSen – Load Pressure Drop sensor fault

This alarm indicates that the load pressure drop transducer is not operating properly. This transducer is used only with Pump Control VPF.

Symptom	Cause	Solution
Pump speed is set with Backup value. Bell icon is moving on controller's display. String in the alarm list: LoadPDSen String in the alarm log: ± LoadPDSen String in the alarm snapshot LoadPDSen	Sensor is broken.	Check for sensor integrity according table and allowed kOhm (kΩ) range. Check for sensor physical integrity.
	Sensor is shorted.	Check if sensor is shorted with a resistance measurement.
	Sensor is not properly connected (open).	Check for absence of water or humidity on electrical contacts. Check for correct plug-in of the electrical connectors. Check for correct sensors wiring also according electrical scheme.

		Check for correct installation of the sensor on refrigerant circuit pipe.
Reset		
Local HMI	<input type="checkbox"/>	
Network	<input type="checkbox"/>	
Auto	<input checked="" type="checkbox"/>	

5.1.16 Password x Over Time

Symptom	Cause	Solution
Pass1TimeOver 1dayleft	Temporary Password Inserted is going to expire. One day is left before Option set is unactivated.	Insert new password
Pass2TimeOver 1dayleft		
Pass3TimeOver 1dayleft		
Reset		Notes
Local HMI	<input checked="" type="checkbox"/>	
Network	<input checked="" type="checkbox"/>	
Auto	<input checked="" type="checkbox"/>	

5.1.17 Unit HRInvAI – Heat Recovery Water Temperature inverted

This alarm is generated if the HR EWT < HR LWT-1°C for a definable time when the circuit is run.

Symptom	Cause	Solution
Unit status is On Bell icon is moving on controller's display. Bell icon is moving on controller's display. String in the alarm list: Unit HRInvAI String in the alarm log: ± Unit HRInvAI String in the alarm snapshot Unit HRInvAI	Transien causing abnormal operation of the evaporator.	Increase the time delay that flagged the alarm.
	Entering and leaving water pipes are reversed.	Check if the water flows in the counter flow respect to the refrigerant.
	Water pump operates reverse.	Check if the chiller works beyond the design limits.
	Entering and Leaving water temperature sensors are inverted	Check cabling of the sensors on the unit controller. Check offset of the two sensors with the water pump running.
Reset		Notes
Local HMI	<input checked="" type="checkbox"/>	
Network	<input checked="" type="checkbox"/>	
Auto	<input type="checkbox"/>	

5.1.18 Glycol leaving water temperature sensor fault

This alarm is generated any time that the input resistance is out of an acceptable range.

Symptom	Cause	Solution
Unit status is On Bell icon is moving on controller's display. Bell icon is moving on controller's display. String in the alarm list: Unit GlycoLVgWTemp String in the alarm log: ± Unit GlycoLVgWTemp String in the alarm snapshot Unit GlycoLVgWTemp	Sensor is broken.	Check for sensor integrity according to table and allowed kOhm (kΩ) range. Check correct sensors operation
	Sensor is shorted.	Check if sensor is shorted with a resistance measurement.
	Sensor is not properly connected (open).	Check for absence of water or humidity on electrical contacts. Check for correct plug-in of the electrical connectors. Check for correct sensors wiring also according to electrical scheme.
Reset		Notes
Local HMI	<input type="checkbox"/>	Automatically clears when the communication is re-established.
Network	<input type="checkbox"/>	
Auto	<input checked="" type="checkbox"/>	

5.1.19 Glycol entering water temperature sensor fault

This alarm is generated any time that the input resistance is out of an acceptable range.

Symptom	Cause	Solution
Unit status is On Bell icon is moving on controller's display.	Sensor is broken.	Check for sensor integrity according to table and allowed kOhm (kΩ) range.

Bell icon is moving on controller's display. String in the alarm list: Unit GlycolEvpwTemp String in the alarm log: ± Unit GlycolEvpwTemp String in the alarm snapshot Unit GlycolEvpwTemp		Check correct sensors operation
	Sensor is shorted.	Check if sensor is shorted with a resistance measurement.
	Sensor is not properly connected (open).	Check for absence of water or humidity on electrical contacts.
		Check for correct plug-in of the electrical connectors.
	Check for correct sensors wiring also according to electrical scheme.	
Reset		Notes
Local HMI Network Auto	<input type="checkbox"/> <input type="checkbox"/> <input checked="" type="checkbox"/>	Automatically clears when the communication is re-established.

5.1.20 Glycol module communication fail

This alarm is generated in case of communication problems with the module related to the glycol free.

Symptom	Cause	Solution
Unit is on. Bell icon is moving on controller's display. String in the alarm list: GlycolModuleCommFail String in the alarm log: ± GlycolModuleCommFail String in the alarm snapshot GlycolModuleCommFail	Module has no power supply	Check the power supply from the connector on the side of the module. Check if LEDs are both green. Check if the connector on the side is tightly inserted in the module
	Led Off	Check if power supply is ok but LEDs are both off. In this case replace the module
	BUS or BSP Led are red	Check if module's address is correct referring to the wiring diagram. If BSP LED is solid red replace the module. BSP error.
Reset		Notes
Local HMI Network Auto	<input type="checkbox"/> <input type="checkbox"/> <input checked="" type="checkbox"/>	Automatically clears when the communication is re-established.

5.1.21 Glycol pump communication fail

This alarm is generated in case of Modbus communication problems with glycol pump.

Symptom	Cause	Solution
Bell icon is moving on controller's display. String in the alarm list: GlycolPmpCommFail String in the alarm log: ± GlycolPmpCommFail String in the alarm snapshot GlycolPmpCommFail	RS485 network is not properly cabled.	Check the continuity of the RS485 network with the unit off. There should be continuity from the main controller to the pump as indicated on the wiring diagram.
	Modbus communication is not running properly.	Check glycol pump address. All the addresses must be different.
	Glycol pump is not powered	Check if the glycol pump is correctly powered.
Reset		Notes
Local HMI Network Auto	<input checked="" type="checkbox"/> <input checked="" type="checkbox"/> <input type="checkbox"/>	

5.1.22 Glycol pump alarm

This alarm is generated in case of generic hardware or operating problem with the glycol pump in the closed loop.

Symptom	Cause	Solution
Unit could be ON. Bell icon is moving on controller's display. String in the alarm list: GlycolPmpAlm String in the alarm log:	Glycol pump may not be operating.	Check for problem in electrical wiring of the glycol pump..
		Check that electrical breaker of glycol pump is tripped.
		If fuses are used to protect the glycol pump, check the integrity of fuses.

± GlycolPmpAlm String in the alarm snapshot GlycolPmpAlm		Check the glycol pump filter and the glycol water circuit for obstructions.
Reset		Notes
Local HMI Network Auto	<input checked="" type="checkbox"/> <input checked="" type="checkbox"/> <input type="checkbox"/>	

5.2 Unit Pumpdown Alarms

All alarms reported in this section produce a unit stop performed following normal pumpdown procedure.

5.2.1 UnitOff EvpEntWTempSen - Evaporator Entering Water Temperature (EWT) sensor fault

This alarm is generated any time the input resistance is out of an acceptable range.

Symptom	Cause	Solution
Unit status is Off. All circuits are stopped with a normal shutdown procedure. Bell icon is moving on controller's display. String in the alarm list: UnitOff EvapEntWTempSen String in the alarm log: ± UnitOff EvapEntWTempSen String in the alarm snapshot UnitOff EvapEntWTempSen	Sensor is broken.	Check for sensor integrity according table and allowed kOhm (kΩ) range. Check for sensor physical integrity.
	Sensor is shorted.	Check if sensor is shorted with a resistance measurement.
	Sensor is not properly connected (open).	Check for absence of water or humidity on electrical contacts.
		Check for correct plug-in of the electrical connectors.
		Check for correct sensors wiring also according electrical scheme. Check for correct installation of the sensor on refrigerant circuit pipe.
Reset		
Local HMI Network Auto	<input checked="" type="checkbox"/> <input checked="" type="checkbox"/> <input checked="" type="checkbox"/>	

5.2.2 UnitOffEvapLvgWTempSen - Evaporator Leaving Water Temperature (LWT) sensor fault

This alarm is generated any time that the input resistance is out of an acceptable range.

Symptom	Cause	Solution
Unit status is Off. All circuits are stopped with a normal shutdown procedure. Bell icon is moving on controller's display. String in the alarm list: UnitOff EvapLvgWTempSen String in the alarm log: ± UnitOffEvapLvgWTempSen String in the alarm snapshot UnitOffEvapLvgWTempSen	Sensor is broken.	Check for sensor integrity according table and allowed kOhm (kΩ) range. Check for sensor physical integrity.
	Sensor is shorted.	Check if sensor is shorted with a resistance measurement.
	Sensor is not properly connected (open).	Check for absence of water or humidity on electrical contacts.
		Check for correct plug-in of the electrical connectors.
		Check for correct sensors wiring also according electrical scheme. Check for correct installation of the sensor on refrigerant circuit pipe.
Reset		
Local HMI Network Auto	<input checked="" type="checkbox"/> <input checked="" type="checkbox"/> <input checked="" type="checkbox"/>	

5.2.3 UnitOffAmbienTempSen - Outside Air Temperature sensor fault

This alarm is generated any time the input resistance is out of an acceptable range.

Symptom	Cause	Solution
Unit status is Off. All circuits are stopped with a normal shutdown procedure. Bell icon is moving on controller's display. String in the alarm list: UnitOffAmbientTempSen String in the alarm log:	Sensor is broken.	Check for sensor integrity according table and allowed kOhm (kΩ) range. Check for sensor physical integrity.
	Sensor is shorted.	Check if sensor is shorted with a resistance measurement.
	Sensor is not properly connected (open).	Check for absence of water or humidity on electrical contacts.

± UnitOffAmbientTempSen String in the alarm snapshot UnitOffAmbientTempSen		Check for correct plug-in of the electrical connectors. Check for correct sensors wiring also according electrical scheme. Check for correct installation of the sensor on refrigerant circuit pipe.
Reset		
Local HMI	<input checked="" type="checkbox"/>	
Network	<input checked="" type="checkbox"/>	
Auto	<input checked="" type="checkbox"/>	

5.2.4 OAT:Lockout - Outside Air Temperature (OAT) Lockout (only in Cooling Mode)

This alarm prevents the unit to start if the outside air temperature is too low. Purpose is to prevent low pressure trips at startup. The limit depends on the fan regulation that is installed on the unit. By default this value is set to 10°C.

Symptom	Cause	Solution
Unit Status is OAT Lockout. All circuits are stopped with a normal shutdown procedure. Bell icon is moving on controller's display. String in the alarm list: StartInhbtAmbTempLo String in the alarm log: ± StartInhbtAmbTempLo String in the alarm snapshot StartInhbtAmbTempLo	Outside ambient temperature is lower than value set into unit's controller.	Check the minimum outside ambient temperature value set into the unit's controller. Check if this value is in accordance with chiller application, therefore check about the proper application and utilization of the chiller.
	Improper operation of Outside Ambient Temperature sensor.	Check for proper operation of OAT sensor according information about kOhm (kΩ) range related to temperature values.
Reset		Notes
Local HMI	<input type="checkbox"/>	It clears automatically with a 2.5°C of hysteresis.
Network	<input type="checkbox"/>	
Auto	<input checked="" type="checkbox"/>	

5.2.5 UnitOffEvpWTempInvrtd – Heat Recovery Water Temperature inverted

This alarm is generated if the EWT < LWT-1°C for a definable time when the circuit is run.

Symptom	Cause	Solution
Unit status is On Bell icon is moving on controller's display. Bell icon is moving on controller's display. String in the alarm list: UnitOffEvpWTempInvrtd String in the alarm log: ± UnitOffEvpWTempInvrtd String in the alarm snapshot UnitOffEvpWTempInvrtd	Transien causing abnormal operation of the evaporator.	Increase the time delay that flagged the alarm.
	Entering and leaving water pipes are reversed.	Check if the water flows in the counter flow respect to the refrigerant.
	Water pump operates reverse.	Check if the chiller works beyond the design limits.
	Entering and Leaving water temperature sensors are inverted	Check cabling of the sensors on the unit controller. Check offset of the two sensors with the water pump running.
Reset		Notes
Local HMI	<input checked="" type="checkbox"/>	
Network	<input checked="" type="checkbox"/>	
Auto	<input type="checkbox"/>	

5.2.6 ExternalPumpdown - External Pumpdown

This alarm indicates that a device, whose operation is linked with this machine, is reporting a problem on the dedicated input.

Symptom	Cause	Solution
Unit status is Run. Bell icon is moving on controller's display. String in the alarm list: External Pumpdown String in the alarm log: ±External Pumpdown String in the alarm snapshot External Pumpdown	There is an external event that has caused the opening, for at least 5 seconds, of the digital input on the controller board.	Check causes of the external event or alarm.
		Check electrical wiring from unit controller to the external equipment in case of any external events or alarms have been occurred.

Reset	
Local HMI	<input type="checkbox"/>
Network	<input type="checkbox"/>
Auto	<input checked="" type="checkbox"/>

5.3 Unit Rapid Stop Alarms

All alarms reported in this section produce an instantaneous stop of the unit.

5.3.1 Power Failure - Power Failure (only for units with the UPS option)

This alarm is generated when the main power is Off and the unit controller is powered by the UPS.



Resolution of this fault requires a direct intervention on the power supply of this unit. Direct intervention on the power supply can cause electrocution, burns or even death. This action must be performed only by trained persons. In case of doubts contact your maintenance company.

Symptom	Cause	Solution
Unit status is Off. All circuits are stopped immediately. Bell icon is moving on controller's display. String in the alarm list: Power Failure String in the alarm log: ± Power Failure String in the alarm snapshot Power Failure	Loss of one phase.	Check voltage level on each of the phases.
	Not correct sequence connection of L1,L2,L3.	Check sequence of L1, L2, L3 connections according indication on chiller's electrical scheme.
	External power supply issue	Black Out
		Fault on the customer-side machine power supply line.
	Check if the customer's differential protection has tripped in case of a ground fault.	
Reset		Notes
Local HMI	<input type="checkbox"/>	
Network	<input type="checkbox"/>	
Auto	<input checked="" type="checkbox"/>	

5.3.2 UnitOff EvapFreeze - Evaporator Water freeze alarm

This alarm is generated to indicate that the water temperature (entering or leaving) has dropped below a safety limit. Control tries to protect the heat exchanger starting the pump and letting the water circulate.

Symptom	Cause	Solution
Unit status is Off. All circuits are stopped immediately. Bell icon is moving on controller's display. String in the alarm list: UnitOff EvapFreeze String in the alarm log: ± UnitOff EvapFreeze String in the alarm snapshot UnitOff EvapFreeze	Water flow too low.	Increase the water flow.
	Inlet temperature to the evaporator is too low.	Increase the inlet water temperature.
	Flow switch is not working.	Check the flow switch and the water pump.
	Sensor readings (entering or leaving) are not properly calibrated.	Check the water temperatures with a proper instrument and adjust the offsets
	Wrong freeze limit setpoint.	The freeze limit has not been changed as a function of glycol percentage.
Reset		
Local HMI	<input checked="" type="checkbox"/>	
Network	<input checked="" type="checkbox"/>	
Auto	<input type="checkbox"/>	

5.3.3 UnitOff ExternalAlarm - External alarm

This alarm is generated to indicate that an external device whose operation is linked with this unit operation. This external device could be a pump or an inverter.

Symptom	Cause	Solution
Unit status is Off. All circuits are switched off with the normal shutdown procedure. Bell icon is moving on controller's display. String in the alarm list: UnitOff ExternalAlarm String in the alarm log: ± UnitOff ExternalAlarm String in the alarm snapshot UnitOff ExternalAlarm	There is an external event that has caused the opening for at least 5 seconds of the port on the controller board.	Check causes of the external event or alarm.
		Check electrical wiring from unit controller to the external equipment in case of any external events or alarms have been occurred.

Reset	
Local HMI	<input type="checkbox"/>
Network	<input type="checkbox"/>
Auto	<input checked="" type="checkbox"/>

5.3.4 UnitOff PVM - PVM

This alarm is generated in case of problems with the power supply to the chiller.



Resolution of this fault requires a direct intervention on the power supply of this unit. Direct intervention on the power supply can cause electrocution, burns or even death. This action must be performed only by trained persons. In case of doubts contact your maintenance company.

Symptom	Cause	Solution
Unit status is Off. All circuits are stopped immediately. Bell icon is moving on controller's display. String in the alarm list: UnitOff PVM String in the alarm log: ± UnitOff PVM String in the alarm snapshot UnitOff PVM	Loss of one phase.	Check voltage level on each of the phases. Replace any broken fuse between the customer transformer protections.
	Not correct sequence connection of L1, L2, L3.	Check sequence of L1, L2, L3 connections according indication on chiller's electrical scheme.
	Voltage level on the unit's panel is not in the allowed range ($\pm 10\%$).	Check that voltage level on each phases is into the allowed range that is indicated on the chiller label. Is important to check the voltage level on each phases not only with chiller not running, but mainly with chiller running from minimum capacity up to full load capacity. That's because voltage drop can occur from a certain unit cooling capacity level, or because of certain working condition (i.e. high values of OAT). In these cases the issue can be related with the sizing of power cables.
Reset		
Local HMI	<input type="checkbox"/>	
Network	<input type="checkbox"/>	
Auto	<input checked="" type="checkbox"/>	

5.3.5 UnitOff EvapWaterFlow - Evaporator Water Flow Loss alarm

This alarm is generated in case of flow loss to the chiller to protect the machine against freezing.

Symptom	Cause	Solution
Unit status is Off. All circuits are stopped immediately. Bell icon is moving on controller's display. String in the alarm list: UnitOff EvapwaterFlow String in the alarm log: ± UnitOff EvapwaterFlow String in the alarm snapshot UnitOff EvapwaterFlow	No/Too low water flow (EEWT-ELWT>0 +/-tolerance 2min after alarm occurrence).	Dirty or obstructed filter.
		Pump impeller unable to rotate.
	Flow Switch issue (EEWT-ELWT=0 +/-tolerance 2min after alarm).	Check pump motor power supply.
		Wrong cut of the paddle.
		Flow switch head plug issues
		Check the incorrect insertion/installation of the flow switch.
Reset		
Local HMI	<input checked="" type="checkbox"/>	
Network	<input checked="" type="checkbox"/>	
Auto	<input type="checkbox"/>	

5.3.6 UnitOff MainContrCommFail – Main Controller Communication Error

This alarm is generated in case of communication problems with the AC module.

Symptom	Cause	Solution
Unit status is Off. All circuits are stopped immediately. Bell icon is moving on controller's display. String in the alarm list:	Module has no power supply	Check the power supply from the connector on the side of the module.
		Check if LEDs are both green.
		Check if the connector on the side is tightly inserted in the module

UnitOff MainContrCommFail String in the alarm log: ± UnitOff MainContrCommFail String in the alarm snapshot UnitOff MainContrCommFail	Led Off	Check if power supply is ok but LEDs are both off. In this case replace the module
	BUS or BSP Led are red	Check if module's address is correct referring to the wiring diagram.
		If BSP LED is solid red replace the module.
		BSP error.
Reset		
Local HMI	<input checked="" type="checkbox"/>	
Network	<input checked="" type="checkbox"/>	
Auto	<input type="checkbox"/>	

5.3.7 UnitOff CC1CommFail - Circuit 1 – CC1 Communication Error

This alarm is generated in case of communication problems with the AC module.

Symptom	Cause	Solution
Unit status is Off. All circuits are stopped immediately. Bell icon is moving on controller's display. String in the alarm list: UnitOff CC1CommFail String in the alarm log: ± UnitOff CC1CommFail String in the alarm snapshot UnitOff CC1CommFail	Module has no power supply	Check the power supply from the connector on the side of the module. Check if LEDs are both green. Check if the connector on the side is tightly inserted in the module
	Led Off	Check if power supply is ok but LEDs are both off. In this case replace the module
	BUS or BSP Led are red	Check if module's address is correct referring to the wiring diagram.
		If BSP LED is solid red replace the module. BSP error.
Reset		
Local HMI	<input checked="" type="checkbox"/>	
Network	<input checked="" type="checkbox"/>	
Auto	<input type="checkbox"/>	

5.3.8 UnitOff CC2CommFail - Circuit 2 – CC2 Communication Error

This alarm is generated in case of communication problems with the AC module.

Symptom	Cause	Solution
Unit status is Off. All circuits are stopped immediately. Bell icon is moving on controller's display. String in the alarm list: UnitOff CC2CommFail String in the alarm log: ± UnitOff CC2CommFail String in the alarm snapshot UnitOff CC2CommFail	Module has no power supply	Check the power supply from the connector on the side of the module. Check if LEDs are both green. Check if the connector on the side is tightly inserted in the module
	Led Off	Check if power supply is ok but LEDs are both off. In this case replace the module
	BUS or BSP Led are red	Check if module's address is correct referring to the wiring diagram.
		If BSP LED is solid red replace the module. BSP error.
Reset		
Local HMI	<input checked="" type="checkbox"/>	
Network	<input checked="" type="checkbox"/>	
Auto	<input type="checkbox"/>	

5.3.9 UnitOffEmergency Stop – Emergency Stop

This alarm is generated any time the Emergency Stop button is activated.



Before resetting the Emergency Stop button please verify that the harmful condition has been removed.

Symptom	Cause	Solution
Unit status is Off. All circuits are stopped immediately.	Emergency stop button has been pushed.	Turning counterclockwise the emergency stop button, the alarm should be cleared.

Bell icon is moving on controller's display. String in the alarm list: UnitOffEmergencyStop String in the alarm log: ± UnitOffEmergencyStop String in the alarm snapshot UnitOffEmergencyStop		
Reset		Notes
Local HMI Network Auto	<input checked="" type="checkbox"/> <input checked="" type="checkbox"/> <input type="checkbox"/>	Please see note on the top.

5.3.10 Glycol Water Freeze alarm

This alarm is generated to indicate that the glycol water temperature (entering or leaving) has dropped below a safety limit. Control tries to protect the intermediate heat exchanger starting the glycol pump and letting the glycol water circulate.

Symptom	Cause	Solution
Unit status is Off. All circuits are stopped immediately. Bell icon is moving on controller's display. String in the alarm list: UnitOff GlycolFreeze String in the alarm log: ± UnitOff GlycolFreeze String in the alarm snapshot UnitOff GlycolFreeze	Glycol Water flow too low.	Increase the water flow. Check the glycol pump
	Inlet temperature to the evaporator is too low.	Increase the inlet water temperature.
	Sensor's readings (entering or leaving) are not properly calibrated.	Check the glycol water temperatures with a proper instrument and adjust the offsets
	Wrong freeze limit setpoint.	The glycol freeze limit has not been changed as a function of glycol percentage.
Reset		Notes
Local HMI Network Auto	<input checked="" type="checkbox"/> <input checked="" type="checkbox"/> <input type="checkbox"/>	It's required to check if the intermediate heat exchanger has any damage due to this alarm.

5.4 Circuit Events

5.4.1 Cx CompXStartFail – Compressor starting fail event

This event is generated to indicate that the compressor 'x' did not start correctly.

Symptom	Cause	Solution
Compressor status is Off. If the compressor was the first to switch on, the circuit is switched off with the normal shutdown procedure. Otherwise, the circuit will run with the other compressor on. String in the event list: CmpXStartFailed String in the event log: ± CmpXStartFailed String in the snapshot CmpXStartFailed	Compressor is blocked.	Check for compressor integrity. Check in test mode if the compressor starts manually and create Delta Pressure.
	Compressor is broken.	Check for compressor integrity. Check for correct compressor wiring also according with electrical scheme.
Local HMI Network Auto		

5.4.2 Cx DischTempUnload – High Discharge Temperature Unload event

This event is generated to indicate that the circuit partialized, shutting down a compressor, due to the high value of Discharge temperature detected. This is important for compressor reliability.

Symptom	Cause	Solution
The Circuit reduces its capacity if the DischTmp > DischTmpUnload.	The circuit is working outside the compressor envelope.	Check the working conditions, if the unit is working inside the unit envelope, and if the expansion valve is working well.

<p>If the compressor was the first to switch on, the circuit is switched off with the normal shutdown procedure. Otherwise, the circuit will run with the other compressor on. String in the event list: Cx DischTempUnload String in the event log: ± Cx DischTempUnload String in the snapshot Cx DischTempUnload</p>	<p>One of the compressors is damaged.</p>	<p>Check if the compressors are working properly, in normal conditions and without noises.</p>
<p>Local HMI Network Auto</p>		

5.4.3 Cx EvapPressUnload – Low Evaporator Pressure Unload event

This event is generated to indicate that the circuit partialized, shutting down a compressor, due to the low value of Evaporator pressure detected. This is important for compressor reliability.

Symptom	Cause	Solution
<p>The Circuit reduces its capacity if the EvapPr < EvapPressUnload. If only one compressor is running, the circuit will maintain its capacity. Otherwise, the circuit will shut down one compressor each X sec, till the evaporator pressure increase. String in the event list: Cx EvapPressUnload String in the event log: ± Cx EvapPressUnload String in the snapshot Cx EvapPressUnload</p>	<p>The circuit is working outside the compressor envelope.</p>	<p>Check if the EXV is working well. Check the working conditions, if the unit is working inside the unit envelope, and if the expansion valve is working well.</p>
	<p>The outside air temperature is too low (in heat mode).</p>	<p>Check if the unit is working correctly inside the unit envelope. The Circuit is near the Defrost request.</p>
	<p>The leaving water temperature is too low (Cool Mode)</p>	<p>Check if the unit is working correctly inside the unit envelope.</p>
<p>Local HMI Network Auto</p>		

5.4.4 Cx CondPressUnload – High Condenser Pressure Unload event

This event is generated to indicate that the circuit partialized, shutting down a compressor, due to the high value of Condensing pressure detected. This is important for compressor reliability.

Symptom	Cause	Solution
<p>The Circuit reduces its capacity if the CondPr > CondPressUnload. If only one compressor is running, the circuit will maintain its capacity. Otherwise, the circuit will shut down one compressor each X sec, till the condenser pressure decrease. String in the event list: Cx CondPressUnload String in the event log: ± Cx CondpPressUnload String in the snapshot Cx CondPressUnload</p>	<p>The circuit is working outside the compressor envelope.</p>	<p>Check for ice on evaporator (Heat mode). Check the working conditions, if the unit is working inside the unit envelope, and if the expansion valve is working well.</p>
	<p>The outside air temperature is high (in cool mode).</p>	<p>Check the correct functioning of the fans (in cool mode).</p>
	<p>The leaving water temperature is too high (Heat Mode)</p>	<p>Check if the unit is working correctly inside the unit envelope.</p>
<p>Local HMI Network Auto</p>		

5.4.5 Cx HighPressPd – High Pressure during Pumpdown event

This event is generated during a pumpdown procedure, to indicate that the condensing pressure goes above the unload value.

Symptom	Cause	Solution
The Circuit stops the pumpdown procedure if the CondPr > CondPressUnload. String in the event list: Cx HighPressPd String in the event log: ± Cx HighPressPd String in the snapshot Cx HighPressPd	The pumpdown procedure was taking too long.	Check if the EXV is working well, and if it is fully close during pumpdown. Check the working conditions, if the unit is working inside the unit envelope, and if the expansion valve is working well.
Local HMI Network Auto		

5.4.6 Cx Fan Error

This alarm indicates that at least one fan of the circuit has a problem.

Symptom	Cause	Solution
Circuit status is On. The compressor keeps operating as normal. Bell icon is moving on controller's display. String in the alarm list: Cx Fan Error String in the alarm log: ± Cx Fan Error String in the alarm snapshot Cx Fan Error	At least one fan of the circuit is in communication or hardware error.	Try to clear the error by turning the power off and on again after some minutes.
Reset		Notes
Local HMI Network Auto	<input checked="" type="checkbox"/> <input checked="" type="checkbox"/> <input type="checkbox"/>	A service engineer can check the alarm message error provided by each fan VFD.

5.4.7 Cx Fans Communication Error

This event indicates a communication problem with some fans (but not all) of the circuit.

Symptom	Cause	Solution
Circuit status is On. Bell icon is moving on controller's display. String in the alarm list: Cx FanCommError String in the alarm log: ± Cx FanCommError String in the alarm snapshot Cx FanCommError	RS485 network is not properly cabled.	Check the continuity of the RS485 network with the unit off. There should be continuity from the main controller to the last fan as indicated on the wiring diagram.
	Modbus communication is not running properly.	Check fans addresses. All the addresses must be different.
	Fans are not powered	Check if the fans are correctly powered.
Reset		Notes
Local HMI Network Auto	<input checked="" type="checkbox"/> <input checked="" type="checkbox"/> <input checked="" type="checkbox"/>	The alarm clears automatically when the communication is re-established.

5.4.8 Cx Fan Over V

This alarm indicates that some fans (but not all) of the circuit have over voltage problems.

Symptom	Cause	Solution
Circuit status is On. The compressor keeps operating as normal. Bell icon is moving on controller's display. String in the alarm list: Cx Fan OverV String in the alarm log: ± Cx Fan OverV String in the alarm snapshot Cx Cx Fan OverV	Some fans of the circuit has a problem	Check if power supply is within the acceptable tolerance the fans
		Check if the fans have had a problem of lost rotor during the start.
Reset		Notes
Local HMI Network Auto	<input checked="" type="checkbox"/> <input checked="" type="checkbox"/> <input checked="" type="checkbox"/>	A service engineer can check the alarm message error provided by each fan VFD.

5.4.9 Cx Fan Under V

This alarm indicates that some fans (but not all) of the circuit have under voltage problems.

Symptom	Cause	Solution
Circuit status is On. The compressor keeps operating as normal. Bell icon is moving on controller's display. String in the alarm list: Cx Fan UnderV String in the alarm log: ± Cx Fan UnderV String in the alarm snapshot Cx Cx Fan UnderV	Some fans of the circuit has a problem	Check if power supply is within the acceptable tolerance the fans
		Check the correct cabling of the fans
Reset		Notes
Local HMI Network Auto	<input checked="" type="checkbox"/> <input checked="" type="checkbox"/> <input checked="" type="checkbox"/>	A service engineer can check the alarm message error provided by each fan VFD.

5.4.10 CxStartFail - Start Fail

This alarm is generated with a low evaporating pressure and a low saturated condensing temperature at the starting of the circuit. This alarm is auto-reset just occurs, as the unit tries automatically to restart the circuit. At the third occurrence of this failure a Restart Fault Alarm is generated.

Symptom	Cause	Solution
Circuit status is Off. The circuit is stopped. Bell icon is moving on controller's display. Led on the button 2 of External HMI is blinking String in the event list: +Cx StartFailAlm String in the event log: ± Cx StartFailAlm String in the event snapshot: Cx StartFail Alm	Low outside ambient temperature	Check the operating condition of the condenser-less unit
	Refrigerant charge low.	Check sight glass on liquid line to see if there is flash gas. Measure sub-cooling to see if the refrigerant charge is correct.
	Condensing Setpoint not correct for the application	Check if is necessary to increase the condensing saturated temperature setpoint
	Dry cooler not correctly installed	Check that the dry cooler is safe from strong wind
	Evaporator or condensing sensor pressure broken or not correctly installed	Check the proper operation of the pressure transducers.
Reset		
Local HMI Network Auto	<input checked="" type="checkbox"/> <input type="checkbox"/> <input checked="" type="checkbox"/>	

5.5 Circuit Alerts

All alarms reported in this section does not produce a circuit stop, but only a visual information and an item in the alarm log.

5.5.1 CmpX Protection – Compressor Protection

This alarm is generated when the compressor internal protection trips

Symptom	Cause	Solution
Compressor X is Off Bell icon is moving on controller's display. String in the alarm list: CmpX Protection String in the alarm log: ± CmpX Protection String in the alarm snapshot CmpX Protection	Motor stucked/blocked.	Check the correct il charge (if it is too low).
		Check if compressor aspires too much liquid (low SSH).
	Motor over temperature.	Check if motor winding resistance is damaged.
		Compressor is working out of its operating limits.
		Check that too high values of SSH cause the incorrect EXV operating conditions.
		Check for the correct phases sequence (L1, L2, L3) in the electrical connection of the compressor.
Reset		
Local HMI	<input checked="" type="checkbox"/>	
Network	<input checked="" type="checkbox"/>	
Auto	<input type="checkbox"/>	

5.5.2 CompXOff DischTmp CompXSenf – Discharge Temperature of compressor sensor fault

This alarm indicates that the discharge temperature sensor, put one for each compressor, is not operating properly. The related compressor is inhibited after the failure of the corresponding temperature sensor.

These sensors are placed with the Option “DLT Logic” enabled.

Symptom	Cause	Solution
Compressor is switched Off. The circuit is switched off with the normal shutdown procedure only when all compressors showed the same alarm. Bell icon is moving on controller's display. String in the alarm list: DischTmp CompXSen String in the alarm log: ± DischTmp CompXSen String in the alarm snapshot Cx DischTmp CompXSen	Sensor is shorted.	Check for sensor integrity according table and allowed kOhm (kΩ) range. Check for sensor phisycal integrity.
	Sensor is broken.	Check if sensor is shorted with a resistance measurement.
	Sensor is not properly connected (open).	Check for absence of water or humidity on electrical contacts.
		Check for correct plug-in of the electrical connectors.
		Check for correct sensors wiring also according electrical scheme.
		Check for correct installation of the sensor on refrigerant circuit pipe.
Reset		
Local HMI	<input checked="" type="checkbox"/>	
Network	<input checked="" type="checkbox"/>	
Auto	<input checked="" type="checkbox"/>	

5.5.3 Cx Off LiquidTempSen - Liquid Temperature Sensor fault

This alarm is generated to indicate that the sensor is not reading properly.

Symptom	Cause	Solution
Circuit status is Off. The circuit is switched off with the normal shutdown procedure. Bell icon is moving on controller's display. String in the alarm list: Cx LiquidTempSen String in the alarm log: ± Cx LiquidTempSen String in the alarm snapshot Cx LiquidTempSen	Sensor is shorted.	Check for sensor integrity according table and allowed kOhm (kΩ) range. Check for sensor phisycal integrity.
	Sensor is broken.	Check if sensor is shorted with a resistance measurement.
	Sensor is not properly connected (open).	Check for absence of water or humidity on electrical contacts.
		Check for correct plug-in of the electrical connectors.
		Check for correct sensors wiring also according electrical scheme.

		Check for correct installation of the sensor on refrigerant circuit pipe.
Reset		
Local HMI	<input checked="" type="checkbox"/>	
Network	<input checked="" type="checkbox"/>	
Auto	<input checked="" type="checkbox"/>	

5.6 Circuit Pumpdown Stop Alarms

All alarms reported in this section produce a circuit stop performed following normal pumpdown procedure.

5.6.1 Cx Off DischTmpSen - Discharge Temperature Sensor fault

This alarm is generated to indicate that the sensor is not reading properly.

Symptom	Cause	Solution
Circuit status is Off. The circuit is switched off with the normal shutdown procedure. Bell icon is moving on controller's display. String in the alarm list: CxOff DischTmpSen String in the alarm log: ± CxOff DischTmpSen String in the alarm snapshot CxOff DischTmpSen	Sensor is shorted.	Check for sensor integrity according table and allowed kOhm (kΩ) range. Check for sensor physical integrity.
	Sensor is broken.	Check if sensor is shorted with a resistance measurement.
	Sensor is not properly connected (open).	Check for absence of water or humidity on electrical contacts.
		Check for correct plug-in of the electrical connectors.
		Check for correct sensors wiring also according electrical scheme.
		Check for correct installation of the sensor on refrigerant circuit pipe.
Reset		
Local HMI	<input checked="" type="checkbox"/>	
Network	<input checked="" type="checkbox"/>	
Auto	<input checked="" type="checkbox"/>	

5.6.2 CxOff OffSuctTempSen - Suction Temperature Sensor fault

This alarm is generated to indicate that the sensor is not reading properly.

Symptom	Cause	Solution
Circuit status is Off. The circuit is switched off with the normal shutdown procedure. Bell icon is moving on controller's display. String in the alarm list: CxOff OffSuctTempSen String in the alarm log: ± CxOff OffSuctTempSen String in the alarm snapshot CxOff OffSuctTempSen	Sensor is shorted.	Check for sensor integrity according table and allowed kOhm (kΩ) range. Check for sensor physical integrity.
	Sensor is broken.	Check if sensor is shorted with a resistance measurement.
	Sensor is not good connected (open).	Check for absence of water or humidity on electrical contacts.
		Check for correct plug-in of the electrical connectors.
		Check for correct sensors wiring also according electrical scheme.
		Check for correct installation of the sensor on refrigerant circuit pipe.
Reset		
Local HMI	<input checked="" type="checkbox"/>	
Network	<input checked="" type="checkbox"/>	
Auto	<input checked="" type="checkbox"/>	

5.6.3 CxOff GasLeakage - Gas Leakage fault

This alarm indicates a gas leakage in the compressor box.

Symptom	Cause	Solution
Circuit status is Off. The circuit is switched off with the shutdown procedure performing a deep pumpdown of the circuit. Bell icon is moving on controller's display. String in the alarm list: CxOff GasLeakage	Gas leakage in the compressors box (A/C units).	Switch off the unit and perform a gas leakage test.
	Leak Detector is not measuring properly.	Check the actual calibration of the leak detector.

String in the alarm log: ± CxOff GasLeakage String in the alarm snapshot CxOff GasLeakage	Leak detector is not properly connected to the controller.	Check the connection of the leak detector with reference to the wiring diagram of the unit.
Reset		
Local HMI	<input checked="" type="checkbox"/>	
Network	<input checked="" type="checkbox"/>	
Auto	<input type="checkbox"/>	

5.7 Circuit Rapid Stop alarms

All alarms reported in this section produce an instantaneous stop of the circuit.

5.7.1 CxOff CondPressSen - Condensing Pressure sensor fault

This alarm indicates that the condensing pressure transducer is not operating properly.

Symptom	Cause	Solution
Circuit status is Off. The circuit is switched off with the normal shutdown procedure. Bell icon is moving on controller's display. String in the alarm list: CxOff CondPressSen String in the alarm log: ± CxOff CondPressSen String in the alarm snapshot CxOff CondPressSen	Sensor is shorted.	Check for sensor integrity according table and allowed kOhm ($k\Omega$) range. Check for sensor physical integrity.
	Sensor is broken.	Check if sensor is shorted with a resistance measurement.
	Sensor is not good connected (open).	Check for absence of water or humidity on electrical contacts.
		Check for correct plug-in of the electrical connectors. Check for correct sensors wiring also according electrical scheme. Check for correct installation of the sensor on refrigerant circuit pipe.
Reset		
Local HMI	<input checked="" type="checkbox"/>	
Network	<input checked="" type="checkbox"/>	
Auto	<input checked="" type="checkbox"/>	

5.7.2 CxOff EvapPressSen - Evaporating Pressure sensor fault

This alarm indicates that the evaporating pressure transducer is not operating properly.

Symptom	Cause	Solution
Circuit status is Off. The circuit is switched off with the normal shutdown procedure. Bell icon is moving on controller's display. String in the alarm list: CxOff EvapPressSen String in the alarm log: ± CxOff EvapPressSen String in the alarm snapshot CxOff EvapPressSen	Sensor is shorted.	Check for sensor integrity according table and allowed kOhm ($k\Omega$) range. Check for sensor physical integrity.
	Sensor is broken.	Check if sensor is shorted with a resistance measurement.
	Sensor is not good connected (open).	Check for absence of water or humidity on electrical contacts.
		Check for correct plug-in of the electrical connectors. Check for correct sensors wiring also according electrical scheme. Check for correct installation of the sensor on refrigerant circuit pipe.
Reset		
Local HMI	<input checked="" type="checkbox"/>	
Network	<input checked="" type="checkbox"/>	
Auto	<input checked="" type="checkbox"/>	

5.7.3 CxOff DischTmpHigh - High Discharge Temperature Alarm

This alarm indicates that the temperature at the discharge port of the compressor exceeded a maximum limit which may cause damages to the mechanical parts of the compressor.



When this alarm occurs compressor's crankcase and discharge pipes may become very hot. Be careful when getting in contact with the compressor and discharge pipes in this condition.

Symptom	Cause	Solution
Discharge Temperature > High Discharge Temperature alarm value. Alarm cannot trigger if discharge temperature sensor fault is active. Bell icon is moving on controller's display. String in the alarm list: CxOff DischTempHi String in the alarm log: ± CxOff DischTempHi String in the alarm snapshot CxOff DischTempHi	Presence of air in the circuit.	Check if there are no-condensable gases in the circuit.
	Oil issue.	Check if the oil charge is insufficient.
		Check the correct lubrication of the motor.
	Discharge temperature sensor could not operate properly.	Check for proper operation of the discharge temperature
	Compressor issue	Check if the compressors are working properly, in normal condition and without noises.
High SSH		Check that too high values of SSH cause incorrect EXV operating conditions.
Reset		
Local HMI	<input checked="" type="checkbox"/>	
Network	<input checked="" type="checkbox"/>	
Auto	<input type="checkbox"/>	

5.7.4 CxOff CondPressHigh – High Condensing Pressure alarm

This alarm is generated in case the Condensing saturated temperature rise above the Maximum condensing saturated temperature and the control is not able to compensate to this condition.

In case of water cooled chillers operating at high condenser water temperature, if the Condensing saturated temperature exceeds the Maximum condenser saturated temperature, the circuit is only switched off without any notification on the screen as this condition is considered acceptable in this range of operation.

Symptom	Cause	Solution
Circuit status is Off. The compressor does not load anymore or even unload, circuit is stopped. Bell icon is moving on controller's display. String in the alarm list: CxOff CondPressHi String in the alarm log: ± CxOff CondPressHi String in the alarm snapshot CxOff CondPressHi	One or more condenser fans do not operate properly.	Check if fans protections have been activated.
		Check that the fans can turn freely.
		Check that there is not any obstacle to the free ejection of the air blown.
	Check valve malfunction.	Move the valve stem manually to check if is completely closed; if not, there is the possibility of refrigerant migration. In this case replace it.
	Inlet air temperature of the condenser is too high.	The air temperature measured at the inlet of the condenser may not exceed the limit indicated in the operational range (working envelope) of the chiller.
		Check the location where the unit is installed and check that there are no any short circuit of the hot-air blown from the fans of the same unit, or even from fans of next chillers (Check IOM for proper installation).
Presence of air in the circuit.	Check if there are no-condensable gases in the circuit.	
Condensing pressure transducer could not operate properly.	Check for proper operation of the high pressure sensor.	
Reset		
Local HMI	<input checked="" type="checkbox"/>	
Network	<input checked="" type="checkbox"/>	
Auto	<input type="checkbox"/>	

5.7.5 CxOff EvapPressLow - Low Pressure alarm

This alarm is generated in case the evaporating pressure drops below the Low Pressure Unload and the control is not able to compensate to this condition.

Symptom	Cause	Solution
Circuit status is Off. The compressor does not load anymore or even unload, circuit is stopped immediately. Bell icon is moving on controller's display.	Low Water flow	Set the proper flow according to the unit specifics.
	Refrigerant charge is low.	Check sight glass on liquid line to see if there is flash gas.
		Measure sub-cooling to see if the charge is correct.

String in the alarm list: CxOff EvapPressLo String in the alarm log: ± CxOff EvapPressLo String in the alarm snapshot CxOff EvapPressLo	High Evaporator Approach.	Clean evaporator heat exchanger.
	Exv Driver Error	Check EXV driver Alarm Leds in the bottom left-hand corner next to the power pins: only one led should be solid green.
Reset		
Local HMI	<input checked="" type="checkbox"/>	
Network	<input checked="" type="checkbox"/>	
Auto	<input checked="" type="checkbox"/>	

5.7.6 CxOff RestartFault – Restart Fault

This alarm is generated when the compressor internal protection trips

Symptom	Cause	Solution
Compressor X is Off Bell icon is moving on controller's display. String in the alarm list: CxOff RestartsFault String in the alarm log: ± CxOff RestartsFault String in the alarm snapshot CxOff RestartsFault	Ambient temperature or water temperature is too low.	Check the operating envelope for this machine.
	Incorrect sequencing of the valve states.	Check if the valve has carried out the pre-opening correctly.
	EXV not working properly	Check EXV driver Alarm Leds in the bottom left-hand corner next to the power pins: only one led should be solid green.
		Check the connection to the valve driver on the wiring diagram. Check EXV movements.
Reset		
Local HMI	<input checked="" type="checkbox"/>	
Network	<input checked="" type="checkbox"/>	
Auto	<input type="checkbox"/>	

5.7.7 CxOff MechHighPress - Mechanical High Pressure Alarm

This alarm is generated when the condenser pressure rises above the mechanical high pressure limit causing this device to open the power supply to all the auxiliary relays. This causes an immediate shutdown of compressor and all the other actuators in this circuit.

Symptom	Cause	Solution
Circuit status is Off. The compressor does not load anymore or even unload, circuit is stopped. Bell icon is moving on controller's display. String in the alarm list: CxOff MechHighPress String in the alarm log: ± CxOff MechHighPress String in the alarm snapshot CxOff MechHighPress	One or more condenser fans do not operate properly.	Check if fans protections have been activated.
		Check that the fans can turn freely.
		Check that there is not any obstacle to the free ejection of the air blown.
	Dirty or partially blocked condenser coil.	Remove any obstacle. Clean the condenser coil using soft brush and blower.
	Inlet air temperature of the condenser is too high.	The air temperature measured at the inlet of the condenser may not exceed the limit indicated in the operational range (working envelope) of the chiller (A/C units).
		Check the location where the unit is installed and check that there are no any short circuit of the hot-air blown from the fans of the same unit, or even from fans of next chillers (Check IOM for proper installation).
Presence of air in the circuit.	Check if there are no-condensable gases in the circuit.	
Mechanical high pressure switch is damaged or not calibrated.	Check for proper operation of the high pressure switch.	
Reset		
Local HMI	<input checked="" type="checkbox"/>	
Network	<input checked="" type="checkbox"/>	
Auto	<input type="checkbox"/>	

5.7.8 CxOff NoPressChgStart - No Pressure Change At Start Alarm

This alarm indicates that the compressor is not able to start or to create a certain minimum variation of the evaporating or condensing pressures after start.

Symptom	Cause	Solution
Circuit status is Off. The circuit is stopped. Bell icon is moving on controller's display. String in the alarm list: CxOff NoPressChgStart String in the alarm log: ± CxOff NoPressChgStart String in the alarm snapshot CxOff NoPressChgStart	Compressor issue.	Check if the start signal is properly connected to the controller.
		Check correct phases sequence to the compressor (L1, L2, L3) according to the electrical scheme.
	Refrigerant circuit is empty of refrigerant.	Check circuit pressure and presence of refrigerant.
	Not proper operation of evaporating or condensing pressure transducers.	Check proper operation of evaporating or condensing pressure transducers.
Reset		
Local HMI	<input checked="" type="checkbox"/>	
Network	<input checked="" type="checkbox"/>	
Auto	<input type="checkbox"/>	

5.7.9 CompXAlm – Compressor starting fail alarm

This event is generated to indicate that the compressor 'x' did not start correctly. The compressor doesn't generate a correct lift.

Symptom	Cause	Solution
Compressor status is Off. If the compressor switches on, the circuit is switched off with the normal shutdown procedure. Otherwise, the circuit will run with the other compressor on. String in the event list: CmpXAlm String in the event log: ± CmpXAlm String in the snapshot CmpXAlm	Compressor is blocked.	Check for compressor integrity.
		Check in test mode if the compressor starts manually and create Delta Pressure.
	Compressor is broken.	Check for compressor integrity.
		Check for correct compressor wiring also according with electrical scheme.
Reset		
Local HMI	<input checked="" type="checkbox"/>	
Network	<input checked="" type="checkbox"/>	
Auto	<input type="checkbox"/>	

5.7.10 Cx FailedPumpdown - Failed Pumpdown procedure

This alarm is generated to indicate that the circuit hadn't been able to remove all the refrigerant from the evaporator. It automatically clears as soon as the compressor stops just to be logged in the alarm history. It may not be recognized from BMS because the communication latency can give enough time for the reset. It may not even be seen on the local HMI.

Symptom	Cause	Solution
Circuit status is Off. No indications on the screen String in the alarm list: Cx FailedPumpdown String in the alarm log: ± Cx FailedPumpdown String in the alarm snapshot Cx FailedPumpdown	EEXV is not closing completely, therefore there's "short-circuit" between high pressure side with low pressure side of the circuit.	Check for proper operation and full closing position of EEXV. Sight glass should not show refrigerant flow after the valve is closed.
		Check the EXV is not clogged for the presence of debris.
		Check LED on the top of the driver valve; the left LED above the word «Step per #» should be solid red. If both LED are blinking alternately the valve motor is not properly connected.
	Evaporating pressure sensor is not working properly.	Check for proper operation of evaporating pressure sensor.
	Compressor on circuit is internally damaged with a mechanical.	Check compressors on circuits (there may be internal bypass).
Reset		

Local HMI	<input type="checkbox"/>
Network	<input type="checkbox"/>
Auto	<input checked="" type="checkbox"/>

5.7.11 CxOff LowPrRatio - Low Pressure Ratio Alarm

This alarm indicates that the ratio between evaporating and condensing pressure is below a limit that guarantees the proper lubrication to compressor.

Symptom	Cause	Solution
Circuit status is Off. The circuit is stopped. Bell icon is moving on controller's display. String in the alarm list: CxCmp1 LowPrRatio String in the alarm log: ± CxCmp1 LowPrRatio String in the alarm snapshot CxCmp1 LowPrRatio	Compressor is not able to develop the minimum compression.	Check fan setpoint and settings, it could be too low.
		Check compressor absorbed current and if it is turning in the opposite direction. Moreover, check if the start signal is properly connected to the controller.
		Check the correct operation of suction / delivery pressure sensors.
		Check the internal relief valve didn't open during previous operation (check the unit history). Note: If the difference between delivery and suction pressure exceeds 22bar, the internal relief valve open and need to be replaced.
	Inspect the scroll rotor for possible damages (there may be internal bypass).	
Reset		Notes
Local HMI Network Auto	<input checked="" type="checkbox"/> <input checked="" type="checkbox"/> <input type="checkbox"/>	

5.7.12 Fan Fault

This alarm indicates that every fan of the circuit has a problem.

Symptom	Cause	Solution
Circuit status is On. The compressor keeps operating as normal. Bell icon is moving on controller's display. String in the alarm list: Cx FanAlm String in the alarm log: ± Cx FanAlm String in the alarm snapshot Cx FanAlm	Every fan of the circuit has a problem	Try to clear the error by turning the power off and on again after some minutes.
Reset		Notes
Local HMI Network Auto	<input checked="" type="checkbox"/> <input checked="" type="checkbox"/> <input type="checkbox"/>	A service engineer can check the alarm message error provided by each fan VFD.

5.7.13 Fans Modbus Communication Failure

This alarm indicates a communication problem with all fans of the circuit.

Symptom	Cause	Solution
Circuit status is Off. The fans do not start, circuit is immediately stopped. Bell icon is moving on controller's display. String in the alarm list: Cx FanCommFail String in the alarm log: ± Cx FanCommFail String in the alarm snapshot Cx FanCommFail	RS485 network is not properly cabled.	Check the continuity of the RS485 network with the unit off. There should be continuity from the main controller to the last fan as indicated on the wiring diagram.
	Modbus communication is not running properly.	Check fans addresses. All the addresses must be different.
	Fans are not powered	Check if the fans are correctly powered.
Reset		Notes

Local HMI	<input checked="" type="checkbox"/>	The alarm clears automatically when the communication is re-established.
Network	<input checked="" type="checkbox"/>	
Auto	<input checked="" type="checkbox"/>	

5.7.14 CxOff Low DSH – DSH too low

This alarm is generated when the circuit is running with a DSH too low for a certain amount of time.

Symptom	Cause	Solution
Circuit X is Off Bell icon is moving on controller's display. String in the alarm list: CxOff LowDSH String in the alarm log: ± CxOff LowDSH String in the alarm snapshot CxOff LowDSH	EEXV is not working correctly. It's not opening enough or it's moving in the opposite direction.	Check if pump-down can be finished for pressure limit reached;
		Check expansion valve movements.
		Check connection to the valve driver on the wiring diagram.
		Measure the resistance of each winding, it must be different from 0 Ohm.
Reset		
Local HMI	<input checked="" type="checkbox"/>	
Network	<input checked="" type="checkbox"/>	
Auto	<input type="checkbox"/>	

5.7.15 CxOff Drift Suct temp

This alarm is generated when the circuit is running with a DSH too low for a certain amount of time.

Symptom	Cause	Solution
Circuit X is Off Bell icon is moving on controller's display. String in the alarm list: CxOff DriftSuctTmp String in the alarm log: ± CxOff DriftSuctTmp String in the alarm snapshot CxOff DriftSuctTmp	Wrong suction temperature probe reading.	Check for sensor integrity.
		Check correct sensors operation according information about kOhm (kΩ) range related to temperature values.
		Check for correct installation of the sensor on refrigerant circuit pipe.
Reset		
Local HMI	<input checked="" type="checkbox"/>	
Network	<input checked="" type="checkbox"/>	
Auto	<input type="checkbox"/>	

The present publication is drawn up by of information only and does not constitute an offer binding upon Daikin Applied Europe S.p.A.. Daikin Applied Europe S.p.A. has compiled the content of this publication to the best of its knowledge. No express or implied warranty is given for the completeness, accuracy, reliability or fitness for particular purpose of its content, and the products and services presented therein. Specifications are subject to change without prior notice. Refer to the data communicated at the time of the order. Daikin Applied Europe S.p.A. explicitly rejects any liability for any direct or indirect damage, in the broadest sense, arising from or related to the use and/or interpretation of this publication. All content is copyrighted by Daikin Applied Europe S.p.A..

DAIKIN APPLIED EUROPE S.p.A.

Via Piani di Santa Maria, 72 - 00072 Ariccia (Roma) - Italia

Tel: (+39) 06 93 73 11 - Fax: (+39) 06 93 74 014

<http://www.daikinapplied.eu>