



REV	04
Date	01-2023
Supersedes	D-EIMAC01706-18_03EN

Installation, Maintenance and Operation Manual D-EIMAC01706-18_04EN

Air-cooled refrigeration units with scroll compressors

EWAT_B



Contents

1	INTRODUCTION	3
1.1	Precautions against residual risks	3
1.2	General description.....	4
1.3	Information about the refrigerant	4
1.4	Usage.....	5
1.5	Installation information	5
2	INSTALLATION	7
2.1	Storage	7
2.2	Safety.....	7
2.2.1	Safety devices	8
2.3	Receipt of the unit	8
2.4	Handling and lifting	8
2.5	Positioning and assembly.....	10
2.6	Minimum space requirements.....	11
2.7	Noise and sound protection	13
2.8	Water circuit for the connection of the unit	13
2.8.1	Water piping	13
2.8.2	Installing the flow switch.....	14
2.8.3	Heat recovery	14
2.9	Water treatment	15
2.10	Operation limits	16
2.11	Operating stability and minimum water content in the system	19
2.12	Anti-freeze protection for evaporator and recovery exchangers	19
2.13	Electric connections.....	20
2.13.1	Cable requirements	20
2.14	Phase unbalance	20
3	OPERATOR'S RESPONSIBILITIES	21
4	MAINTENANCE	22
4.1	Pressure / temperature table	22
4.2	Routine maintenance.....	23
4.2.1	Microchannel Air Condenser Maintenance	23
4.2.2	Electrical Installation.....	24
4.2.3	Service and limited warranty	24
5	CHECKS FOR THE FIRST START-UP	31
6	IMPORTANT INFORMATION ON THE REFRIGERANT USED	32
6.1	Factory and Field charged units instructions	32
7	PERIODIC CHECKS AND COMMISSIONING OF PRESSURE EQUIPMENT	33
8	DISMISSION AND DISPOSAL	33
9	DURATION	33

LIST OF FIGURES

Fig. 1	– Lifting instructions.....	9
Fig. 2	– Unit levelling	10
Fig. 3	– Minimum space requirements	12
Fig. 4	– Multiple Chiller Installation	13
Fig. 5	– Hydraulic diagram without pump(s) on board (max. operating pressure 20 bar)	14
Fig. 6	– Hydraulic diagram for single V (EWATxx5B) single pump (opt. 78-79/134-135).....	14
Fig. 7	– Hydraulic diagram for single V (EWATxx5B) double pump (opt. 80-81/136-137)	15
Fig. 8	– Hydraulic diagram for Modular V (EWATxx0B) (opt. 78-79-80-81/134-135-136-137).....	15
Fig. 9	– Multi V-Silver Operational limits	16
Fig. 10	– Multi V-Gold Operational limits.....	17
Fig. 11	– Single V-Silver Operational limits.....	17
Fig. 12	– Single V-Gold Operational limits	18
Fig. 13	– Refrigerant circuit diagram (P&ID) standard single circuit unit	27
Fig. 14	– Refrigerant circuit diagram (P&ID) with light freecooling option single circuit unit.....	28
Fig. 15	– Refrigerant circuit diagram (P&ID) with full freecooling option single circuit unit.....	29
Fig. 16	– Description of labels applied on the electrical panel	30

LIST OF TABLES

Table 1	– Acceptable water quality limits.....	16
Table 2	– Evaporator - Fouling factor.....	18
Table 3	– Air heat exchanger - Altitude correction factor.....	18
Table 4	– Minimum percentage of glycol for the low air ambient temperature	19
Table 5	– Pressure / Temperature of the R32.....	22
Table 6	– Standard Routine Maintenance Plan	24
Table 7	– Routine Maintenance Plan for Critical Application and/or Highly Aggressive Environment	26
Table 8	– Checks to be performed before starting the unit.....	31

1 INTRODUCTION

This manual provides information on the standard functions and procedures of all units in the series and is an important supporting document for qualified personnel, but can never replace it.

All units are delivered with **wiring diagrams, certified drawings, nameplate**; and **DOC (Declaration Of Conformity)**; these documents show all technical data for the unit you have bought. In case of any discrepancies between the contents of the manual and the documentation provided with the unit, always rely on the unit because **it is an integral part of this manual.**

Read this manual carefully before installing and starting up the unit.

Improper installation could result in electric shock, short-circuits, leaks, fire or other damage to the equipment or injure to people.

The unit must be installed by professional operators / technicians in compliance with the laws in force in the country of installation.

The start up of the unit must also be performed by authorized and trained personnel and all activities must be carried out in compliance, in full compliance with local laws and regulations.

INSTALLATION AND START UP ARE ABOSOLUTELY FORBIDDEN IF ALL INSTRUCTIONS CONTAINED IN THIS MANUAL ARE NOT CLEAR.

If you are unsure about assistance and for more information, contact an authorized representative of the manufacturer.

1.1 Precautions against residual risks

1. Install the unit according to the instructions set out in this manual
2. Regularly carry out all the maintenance operations foreseen in this manual
3. Wear protective equipment (gloves, eye protection, hard hat, etc.) Suited to the work in hand; do not wear clothes or accessories that can get caught or sucked in by flows of air; tie back long hair before entering the unit
4. Before opening the machine panelling make sure that it is firmly hinged to the machine
5. The fins on heat exchangers and the edges of metal components and panels can cause cuts
6. Do not remove the guards from mobile components while the unit is operating
7. Make sure that mobile component guards are fitted correctly before restarting the unit
8. Fans, motors and belts drives might be running: before entering, always wait for these to stop and take appropriate measures to prevent them from starting up
9. The surfaces of the machine and pipes can get very hot or cold and cause the risk of scalding
10. Never exceed the maximum pressure limit (PS) of the water circuit of the unit.
11. Before removing parts on the pressurised water circuits, close the section of the piping concerned and drain the fluid gradually to stabilise the pressure at the atmospheric level
12. Do not use your hands to check possible refrigerant leaks
13. Disable the unit from the mains using the main switch before opening the control panel
14. Check that the unit has been grounded correctly before starting it
15. Install the machine in a suitable area; in particular, do not install it outdoors if it is intended for use indoors
16. Do not use cables with inadequate sections nor extension cord connections, even for very short periods or emergencies
17. For units with power correction capacitors, wait 5 minutes after removing the electric power supply before accessing the inside of the switch board
18. If the unit is equipped with centrifugal compressors with integrated inverter, disconnect it from the mains and wait a minimum of 20 minutes before accessing it to carry out maintenance: residual energy in the components, which takes at least this length of time to dissipate, poses the risk of electrocution
19. The unit contains pressurised refrigerant gas: the pressurised equipment must not be touched except during maintenance, which must be entrusted to qualified and authorised personnel
20. Connect up the utilities to the unit following the indications set out in this manual and on the panelling of the unit itself
21. In order to avoid an environmental risk, make sure that any leaking fluid is collected in suitable devices in accordance with local regulations.
22. If a part needs to be dismantled, make sure it is correctly re-assembled before starting the unit
23. When the rules in force require the installation of fire-fighting systems near the machine, check that these are suitable for extinguishing fires on electrical equipment and on the lubricating oil of the compressor and the refrigerant, as specified on the safety data sheets of these fluids
24. When the unit is equipped with devices for venting overpressure (safety valves): when these valves are triggered, the refrigerant gas is released at a high temperature and speed; prevent the release of gas from harming people or objects and, if necessary, discharge the gas according to the provisions of EN 378-3 and the local regulations in force.

25. Keep all the safety devices in good working order and check them periodically according to the regulations in force
26. Keep all lubricants in suitably marked containers
27. Do not store inflammable liquids near the unit
28. Solder or braze only empty pipes after removing all traces of lubricant oil; do not use flames or other heat sources close to pipes containing refrigerant fluid
29. Do not use naked flames near the unit
30. The machinery must be installed in structures protected against atmospheric discharge according to the applicable laws and technical standards
31. Do not bend or hit pipes containing pressurised fluids
32. It is not permitted to walk or rest other objects on the machines
33. The user is responsible for overall evaluation of the risk of fire in the place of installation (for example, calculation of the fire load)
34. During transport, always secure the unit to the bed of the vehicle to prevent it from moving about and overturning
35. The machine must be transported according to the regulations in force taking into account the characteristics of the fluids in the machine and the description of these on the safety data sheet
36. Inappropriate transport can cause damage to the machine and even leaking of the refrigerant fluid. Before start-up, the machine must be checked for leaks and repaired accordingly.
37. The accidental discharge of refrigerant in a closed area can cause a lack of oxygen and, therefore, the risk of asphyxiation: install the machinery in a well ventilated environment according to EN 378-3 and the local regulations in force.
38. The installation must comply with the requirements of EN 378-3 and the local regulations in force; in the case of installations indoors, good ventilation must be guaranteed and refrigerant detectors must be fitted when necessary.

1.2 General description

The unit you bought is an “air cooled chiller”, a machine aimed to cool water (or water-glycol mixture) within the limits described in the following manual. The operation of the unit is based on compression, vapor condensation and subsequent evaporation, according to the inverse Carnot cycle. The main components are:

- A scroll compressor to rise the refrigerant vapour pressure from evaporation pressure to condensation pressure;
- A condenser, where high pressure vapour condensate rejecting heat removed from the chilled water in the atmosphere thanks to an air cooled heat exchanger;
- An expansion valve allowing to reduce the pressure of condensed liquid from condensation pressure to evaporation pressure;
- An evaporator (BPHE), where the low pressure liquid refrigerant evaporates to cool the water.

There are also two optional modalities named full freecooling mode and light freecooling mode. During the freecooling mode, the compressor and the expansion valve are bypassed, so only the condenser and the evaporator are used. In case of light freecooling mode, the evaporator used is the same plate heat exchanger used in the standard mode; instead, in case of full freecooling mode, the evaporator is an additional shell & tube heat exchanger and the plate heat exchanger of the standard mode is bypassed too.

All units are fully assembled in the factory and tested before shipping. The EWAT_B range consists of models with a single refrigerant circuit (from 76 to 350 kW) and models with a double refrigerant circuit (from 150 to 701 kW).

The machine uses R32 refrigerant fluid suitable for the entire field of application of the machine.

The controller is pre-wired, set up and tested at the factory. Only normal field connections such as piping, electrical connections and pump interlocks are required, simplifying installation and increasing reliability. All safety and operation control systems are installed at the factory in the control panel.

The instructions in this manual are applicable to all models in this series unless otherwise specified.

1.3 Information about the refrigerant

This product contains R32 refrigerant that has a minimal environmental impact, thanks to its low value of Global Warming Potential (GWP). According to ISO 817, R32 refrigerant is classified as A2L, which is slightly flammable, since the flame propagation rate is low, and non-toxic.

R32 refrigerant can burn slowly when all the following conditions are present:

- The concentration is between the lower and upper flammability limit (LFL & UFL)
- $T_{Wind\ velocity} < propagation\ of\ flame\ velocity$
- $Energy\ of\ the\ ignition\ source > Minimum\ ignition\ energy$

But pose no risk under the normal usage conditions for air-conditioning equipment and work environment.

Physical characteristics of R32 refrigerant

Safety class (ISO 817)	A2L
PED Group	1
Practical limit (kg/m³)	0.061
ATEL/ ODL (kg/m³)	0.30
LFL (kg/m³) @ 60 °C	0.307
Vapour density @25 °C, 101.3 kPa (kg/m³)	2.13
Molecular mass	52.0
Boiling point (° C)	-52
GWP (100 yr ITH)	675
GWP (ARS 100 yr ITH)	677
Autoignition temperature (° C)	648

1.4 Usage

EWAT_B units are designed and built for cooling buildings or industrial processes. The first commissioning on the final plant must be carried out by Daikin technicians, specifically trained for this purpose. Failure to follow this start-up procedure affects the warranty of the supply.

The standard guarantee of this equipment covers parts with proven defects in materials or workmanship. Materials subject to natural consumption are not covered by warranty.

1.5 Installation information

The chiller has to be installed in open air or machinery room (location classification III).

To ensure location classification III a mechanical vent on the secondary circuit(s) has to be installed.

Local building codes and safety standards shall be followed; in absence of local codes and standards refer to EN 378-3:2016 as a guide.

In paragraph “Additional guidelines for safe use of R32” there are provided additional information that should be added to the requirements of safety standards and building codes.

Additional guidelines for safe use of R32 for equipment located in the open air

Refrigerating systems sited in the open air shall be positioned to avoid leaked refrigerant flowing into a building or otherwise endangering people and property.

The refrigerant shall not be able to flow into any ventilation fresh air opening, doorway, trap door or similar opening in the event of a leak. Where a shelter is provided for refrigerating equipment sited in the open air it shall have natural or forced ventilation.

For refrigeration systems installed outside in a location where a release of refrigerant can stagnate e.g. below ground, then the installation shall comply with the requirements for gas detection and ventilation of machinery rooms.

Additional guidelines for safe use of R32 for equipment located in a machinery room

When a machinery room is chosen for the location of the refrigerating equipment it shall be located in accordance with local and national regulations. The following requirements (according to EN 378-3:2016) can be used for the assessment.

- A risk analysis based on the safety principle for a refrigeration system (as determined by the manufacturer and including the charge and safety classification of the used refrigerant) should be conducted to determine if it is necessary to install the chiller in a separate refrigeration machinery room.
- Machinery rooms should not be used as occupied spaces. The building owner or user shall ensure that access is permitted only by qualified and trained personnel doing the necessary maintenance to the machinery room or general plant.
- Machinery rooms shall not be used for storage with the exception of tools, spare parts and compressor oil for the installed equipment. Any refrigerants, or flammable or toxic materials shall be stored as required by national regulations.
- Open (naked) flames shall not be permitted in machinery rooms, except for welding, brazing or similar activity and then only provided the refrigerant concentration is monitored and adequate ventilation is ensured. Such open flames shall not be left unattended.
- A remote switching (emergency type) for stopping the refrigerating system shall be provided outside the room (near the door). A similar acting switch shall be located at a suitable location inside the room.
- All piping and ducting passing through floors, ceiling and walls of machinery room shall be sealed.
- Hot surfaces shall not exceed a temperature of 80 % of the auto-ignition temperature (in °C) or 100 K less than the auto-ignition temperature of the refrigerant, whichever is lower.

Refrigerant	Self-ignition temperature	Maximum surface temperature
R32	648 °C	548 °C

- Machinery rooms shall have doors opening outward and sufficient in number to ensure freedom for persons to escape in an emergency; the doors shall be tight fitting, self-closing and so designed that they can be opened from inside (anti-panic system).

- Special machinery rooms where the refrigerant charge is above the practical limit for the volume of the room shall have a door that either opens directly to the outside air or through a dedicated vestibule equipped with self-closing, tight-fitting doors.
- The ventilation of machinery rooms shall be sufficient both for normal operating conditions and emergencies .
- Ventilation for normal operating conditions shall be in accordance with national regulations.
- The emergency mechanical ventilation system shall be activated by a detector(s), located in the machinery room.
 - This ventilation system must be:
 - independent of any other ventilation system on the site;
 - provided with two independent emergency controls one located outside the machinery room, and the other inside.
 - The emergency exhaust ventilation fan shall:
 - be either in the air flow with the motor outside the airflow, or rated for hazardous areas (according to the assessment);
 - be located to avoid pressurization of the exhaust ductwork in the machinery room;
 - not cause sparks to occur if it contacts the duct material.
 - Airflow of the emergency mechanical ventilation shall be at least:

$$V = 0,014 \times m^{2/3}$$

where

V is the air flow rate in m³/s;

m is the mass of refrigerant charge, in kg, in the refrigerating system with the largest charge, any part of which is located in the machinery room;

0.014 It is a conversion factor.

- Mechanical ventilation shall be operated continuously or shall be switched on by the detector.
- Detector shall automatically activate an alarm, start mechanical ventilation and stop the system when it triggers .
- The location of detectors shall be chosen in relation to the refrigerant and they shall be located where the refrigerant from the leak will concentrate.
- The positioning of the detector shall be done with due consideration of local airflow patterns, accounting for location sources of ventilation and louvers. Consideration shall also be given to the possibility of mechanical damage or contamination.
- At least one detector shall be installed in each machinery room or the occupied space being considered and/or at the lowest underground room for refrigerants heavier than air and at the highest point for refrigerants lighter than air.
- Detectors shall be continuously monitored for functioning. In the case of a detector failure, the emergency sequence should be activated as if refrigerant had been detected.
- The pre-set value for the refrigerant detector at 30 °C or 0 °C, whichever is more critical, shall be set to 25 % of the LFL. The detector shall continue to activate at higher concentrations.

Refrigerant	LFL	Threshold level	
R32	0.307 kg/m ³	0.7675 kg/m ³	36000 ppm

- All electrical equipment (not only the refrigerating system) shall be selected to be suitable for use in the zones identified in the risk assessment. Electrical equipment shall be deemed to comply with the requirements if the electrical supply is isolated when the refrigerant concentration reaches 25 % of the lower flammable limit or less.
- Machinery rooms or special machinery rooms shall be **clearly marked** as such on the entrances to the room, together with warning notices indicating that unauthorized persons shall not enter and that smoking, naked light or flames are prohibited. The notices shall also state that, in the event of an emergency, only authorized persons conversant with emergency procedures shall decide whether to enter the machinery room. Additionally, warning notices shall be displayed prohibiting unauthorized operation of the system.
- The owner / operator shall keep an updated logbook of the refrigerating system.



The optional leak detector supplied by DAE with the chiller should be used exclusively to check refrigerant leakage from the chiller itself

2 INSTALLATION

2.1 Storage

In the event that it is necessary to store the unit before installation, it is necessary to observe some precautions:

- do not remove the protective plastic;
- protect the unit from dust, bad weather and any rodents;
- do not expose the unit to direct sunlight;
- do not use heat sources and / or open flames near the machine.

Although the unit is covered with a heat-shrink plastic sheet, it is not intended for long-term storage and must be removed and replaced by tarpaulins or the like, more suitable for a longer period.

Environmental conditions must be within the following limits:

- Minimum ambient temperature : - 20 °C;
- Maximum ambient temperature : +40 °C;
- Maximum R.H. : 95% not condensing.

Storage at a temperature below the minimum can cause damage to the components, instead at a temperature above the maximum causes the opening of the safety valves, with consequent loss of refrigerant. Storage in a humid atmosphere may damage electrical components.

2.2 Safety

All EWAT_B machines are built in compliance with the main European Directives (Machinery Directive, Low Voltage Directive, Electromagnetic Compatibility Directive, PED Pressure Equipment Directive); be sure to receive, together with the documentation, also the Declaration of Conformity (DoC) of the product to the directives.

Before installation and commissioning of the machinery, the people involved in this activity must have acquired the information necessary to perform these tasks, applying all the information gathered in this manual. In particular:

- the unit must be firmly anchored to the ground when it must not be moved;
- the unit can only be lifted using the lifting points marked in yellow fixed to its base;
- always protect operating personnel with personal protective equipment appropriate to the activities to be performed. The individual devices commonly used are: helmet, glasses, gloves, headphones, safety shoes. Further personal and collective protection devices must be adopted after having carried out an adequate analysis of the specific risks in the relevant area, according to the activities to be carried out.
- DAE units can be installed without charge restrictions into machinery rooms or in open air (location class.III).
- According to EN 378-1, a mechanical vent on the secondary circuit(s) has to be installed: to ensure location classification III the system shall be classified as an "indirect vented closed system".

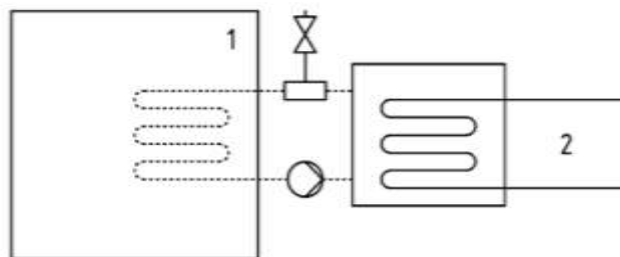

- Indirect vented closed system

Key

- 1) Occupied Space
- 2) Refrigerant containing part(s)

- Machinery rooms shall not be considered occupied space (except as defined in part 3, 5.1: machinery room used as a maintenance workspace shall be considered occupied spaces under access category c).
- Each exchanger (evaporator and condenser) is provided with a safety valve installed on a changeover valve that allows maintenance and periodic checks, without losing a significant amount of refrigerant. Do not leave the safety valve in the intermediate position.
- To prevent damages due to inhalation and direct contact with refrigerant gas, the safety valve outlets must be connected with a conveyor pipe before operations. These pipes must be installed so that, in case the valve opens, the discharged refrigerant flow does not invest people and/or things, or can enter the building through windows and/or other openings.
- The installer is responsible for connecting the safety valve to the purge pipe and pipe dimensioning. In this regard, refer to the harmonized standard EN13136 to dimension the drain pipes to be connected to the safety valves.

- All precautions concerning handling of refrigerant must be observed in accordance with local regulations.

2.2.1 Safety devices

In accordance with the Pressure Equipment Directive the following protection devices are used:

- High pressure switch → safety accessory.
- External relief valve (refrigerant side) → over pressure protection.
- External relief valve (heat transfer fluid side) → **The selection of these relief valves must be made by the personnel responsible for completing the hydraulic circuit(s).**

All factory-installed relief valves are lead-sealed to prevent any calibration change.

If the relief valves are installed on a changeover valve, this is equipped with a relief valve on both outlets. Only one of the two relief valves is operating, the other one is isolated. Never leave the changeover valve in the intermediate position.

If a relief valve is removed for checking or replacement, please ensure that there is always an active relief valve on each of the changeover valves installed in the unit.

2.3 Receipt of the unit

Inspect the unit immediately after delivery. In particular, make sure that the machine is intact in all its parts and that there are no deformations due to impacts. All components described in the delivery note must be inspected and checked. Should any damage occur upon receipt of the machine, do not remove the damaged material and immediately make a written complaint to the transport company, requesting the inspection of the unit; do not repair until inspection by the transport company representative is carried out. Immediately report the damage to the manufacturer representative, a set of photographs is helpful in recognizing responsibility.

The restitution of the machinery is intended as ex-factory Daikin Applied Europe S.p.A.

Daikin Applied Europe S.p.A. declines all responsibility for any damage that the machinery may suffer during transport to the destination.

Use extreme caution when handling the unit to prevent damage to components.

Before installing the unit, check that the model and power supply voltage shown on the nameplate are correct.

Responsibility for any damage after acceptance of the unit cannot be attributed to the manufacturer.

2.4 Handling and lifting

Avoid bumping and/or jolting during loading/unloading unit from the truck and moving it. Do not push or pull the unit from any part other than the base frame. Secure the unit inside the truck to prevent it from moving and causing damages. Do not allow any part of the unit to fall during transportation or loading/unloading.

All units of the series are supplied with lifting points marked in yellow. Only these points may be used for lifting the unit, as shown in the following figure.

Use spacing bars to prevent damage to the condensation bank. Position these above the fan grills at a distance of at least 2.5 meters.

During the handling of the machine it is mandatory to provide all the devices necessary to guarantee personal safety.

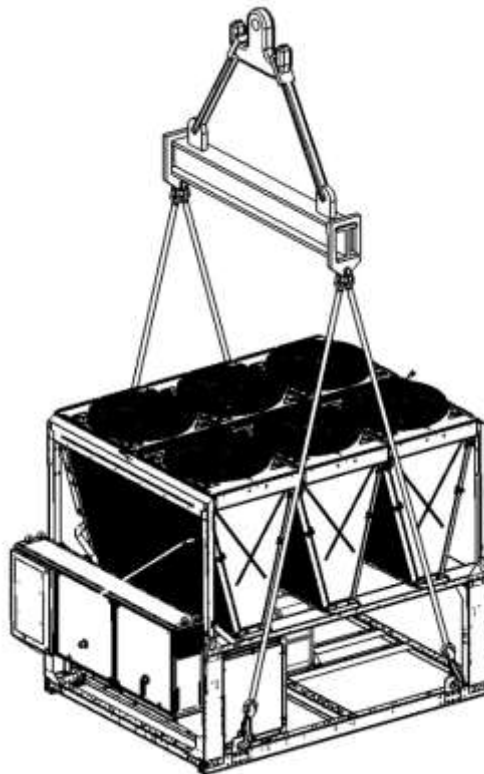

Unit with 4 lifting points

The drawing shows only the 6 fans version.
The lifting mode is the same regardless of the number of fans

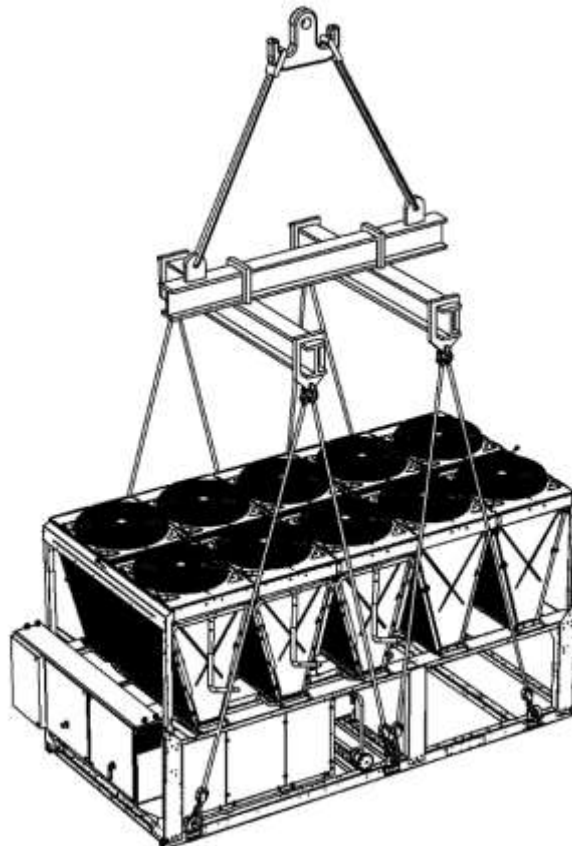

Unit with 6 lifting points

The drawing shows only the 10 fans version.
The lifting mode is the same regardless of the number of fans.

Fig. 1 – Lifting instructions



Consult the dimensional drawing for the hydraulic and electrical connection of the units.

The overall dimensions of the machine, as well as the weights described in this manual, are purely indicative.

The contractual dimensional drawing and the related electrical scheme are delivered to the customer when ordering.

The equipment, ropes, lifting accessories and handling procedures must comply with local regulations and current regulations.

Use only lifting hooks with locking device. The hooks must be securely fixed before handling.

The lifting ropes, hooks and spacing bars must be strong enough to support the unit safely. Please check the unit weight on the unit nameplate.

The installer has the responsibility to ensure the selection and correct use of the lifting equipment. However, it is advisable to use ropes with a minimum vertical capacity equal to the total weight of the machine.

The machine must be lifted with the utmost attention and care following lifting label instructions; lift the unit very slowly, keeping it perfectly level.

2.5 Positioning and assembly

All units are designed for installation outdoors, either on balconies or on the ground, provided that the installation area is free of obstacles that could reduce air flow to the condensers coil.

The unit must be installed on a robust and perfectly level foundation; should the unit be installed on balconies or roofs, it might be necessary to use weight distribution beams.

For installation on the ground, a strong concrete base, at least 250 mm thickness and wider than the unit must be provided. This base must be able to support the weight of the unit.

The unit must be installed above antivibrating mounts (AVM), rubber or spring types. The unit frame must be perfectly levelled above the AVM.

Installation such as in the figure 3 must always be avoided. In case the AVM are not adjustable the flatness of the unit frame must be guaranteed by using metal plate spacers.

Before unit commissioning, the flatness must be verified by using a laser levelling device or other similar devices. The flatness shall not be over 5 mm for units within 7 m length and 10 mm for units over 7 m.

If the unit is installed in places that are easily accessible to people and animals, it is advisable to install protection grids for the condenser and compressor sections.

To ensure best performance on the installation site, the following precautions and instructions must be followed:

- avoid air flow recirculation;
- make sure that there are no obstacles to hamper air flow;
- make sure to provide a strong and solid foundation to reduce noise and vibrations;
- avoid installation in particularly dusty environments, in order to reduce soiling of condensers coils;
- the water in the system must be particularly clean and all traces of oil and rust must be removed. A mechanical water filter must be installed on the unit inlet piping;
- avoid the refrigerant discharge from the safety valves at the installation site. If necessary, it is possible to connect them with exhaust pipes whose cross-section and length must comply with national laws and European directives.

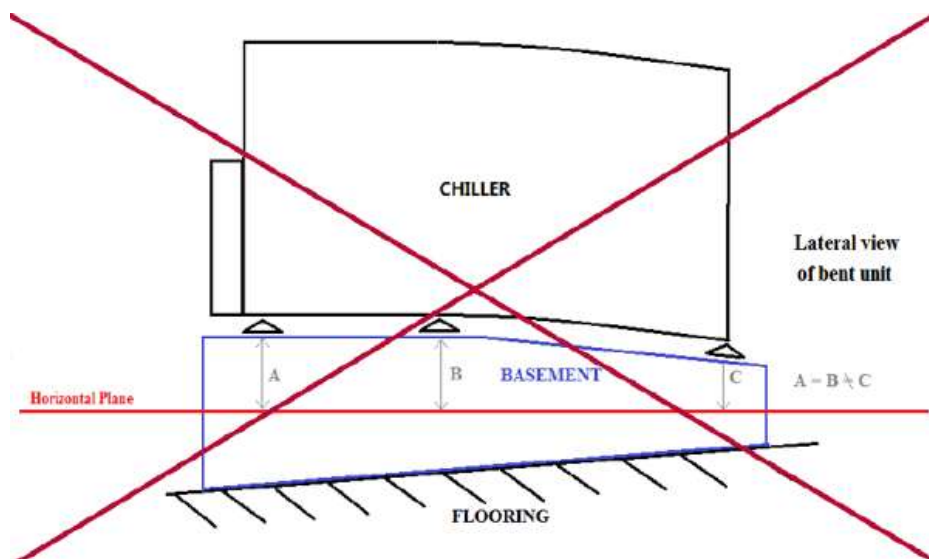

Fig. 2 – Unit levelling

2.6 Minimum space requirements

It is fundamental to respect minimum distances on all units in order to ensure optimum ventilation to the condenser coils. When deciding where to position the unit and to ensure a proper air flow, the following factors must be taken into consideration:

- avoid any warm air recirculation;
- avoid insufficient air supply to the air-cooled condenser.

Both these conditions can cause an increase of condensing pressure, which leads to a reduction in energy efficiency and refrigerating capacity.

Any side of the unit must be accessible for post-installation maintenance operations and vertical air discharge must not be obstructed. Figure below shows the minimum space required.

Vertical air discharge must not be obstructed for at least 5000mm.

In case of two chillers installed in free field, minimum recommended distance between them is 3600 mm; in case of two chillers in a row, minimum distance is 1500 mm. The pictures below show examples of recommended installations.

Should the unit be installed without observing the recommended minimum distances from walls and/or vertical obstacles, there could be a combination of warm air recirculation and/or insufficient supply to the air-cooled condenser which could cause a reduction of capacity and efficiency.

In any case, the microprocessor will allow the unit to adapt itself to new operating conditions and deliver the maximum available capacity under any given circumstances, even if the lateral distance is lower than recommended, unless the operating conditions should affect personnel safety or unit reliability.

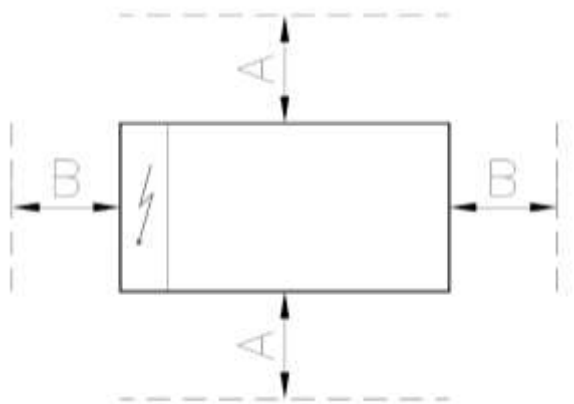

	Single V	Multi V
A	1100 mm	2200 mm
B	1100 mm	1500 mm

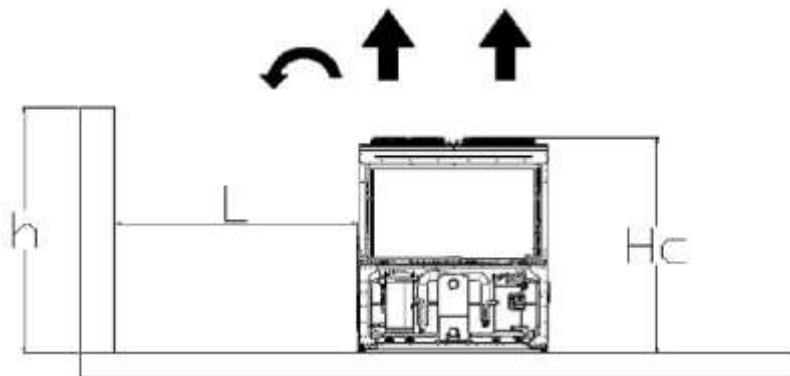

If $h < H_c \rightarrow L \geq 3,0$ m (multi V) / $L \geq 1,8$ m (single V); if $h > H_c$ or L is lower than recommended contact your Daikin distributor to evaluate the various possible arrangements.

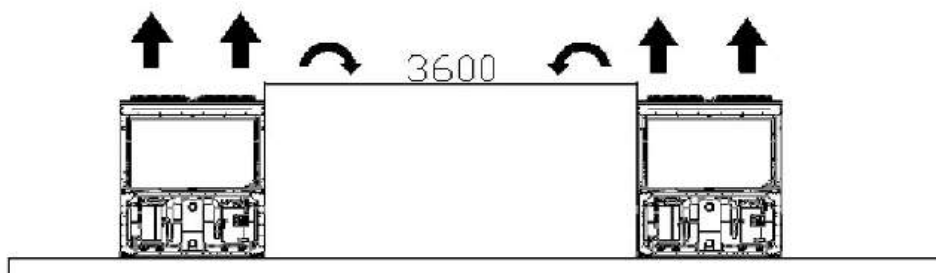

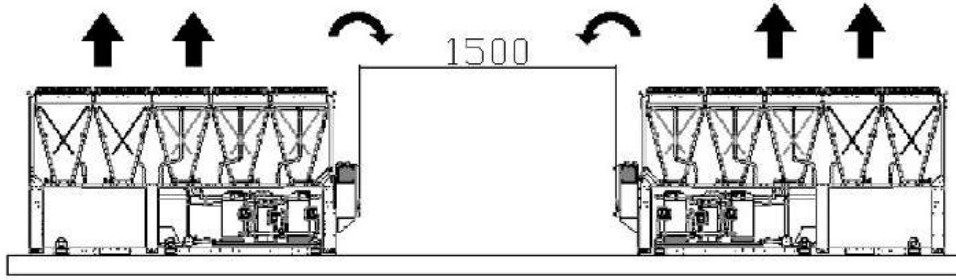

Fig. 3 – Minimum space requirements

The minimum distances, reported above, ensure functionality of the chiller in most applications. However, there are specific situations which include multiple chiller installation; in this case the following recommendations are to be followed:

Multiple chiller installed side by side in a free field with dominant wind

Considering an installation in areas with a dominant wind from a specific direction (as shown in the following fig.):

- Chiller N°1: is performing normally without any ambient over-temperature.
- Chiller N° 2: is working in a warmed ambient. The chiller is working with air recirculating from Chiller 1 and recirculation from itself.
- Chiller N° 3: is working in an over-temperature ambient due to the recirculating air from the other two chillers.

In order to avoid the hot air recirculation due to dominant winds, the installation where all chillers are aligned to the dominant wind is preferred (see figure below).

Multiple chiller installed side by side in a compound

In case of compounds with walls of the same height of the chillers or higher, the installation is not recommended. Chiller 2 and chiller 3 work with sensible higher temperature due to the enhanced recirculation. In this case special precautions must be taken in to account according to the specific installation (eg: louvered walls, install the unit on base frame in order to increase the height, ducts on the discharge of the fans, high lift fans, etc).

All the above cases are even more sensitive in case of design conditions close to the limits of the unit operating envelope.

NOTE: Daikin cannot be considered responsible in case of malfunctions generated by hot air recirculation or insufficient airflow as result of improper installation if the above recommendations are ignored.

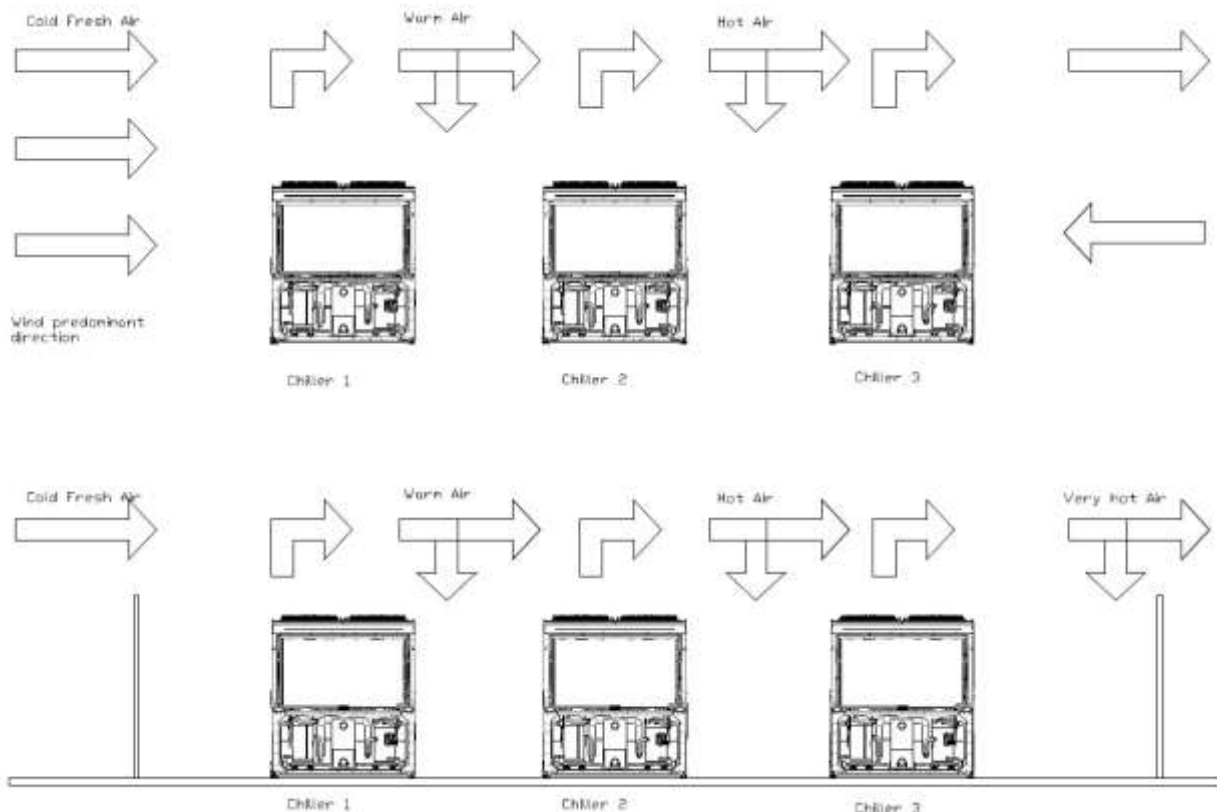

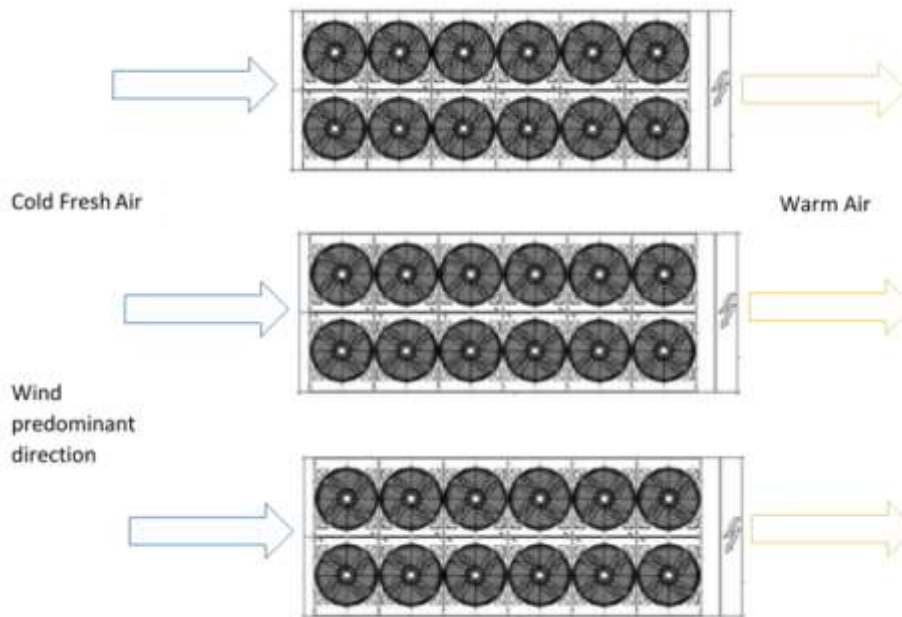

Fig. 4 – Multiple Chiller Installation

2.7 Noise and sound protection

The unit is a source of noise mainly due to rotation of compressors and fans.

The noise level for each model size is listed in sales documentation.

If the unit is correctly installed, operated, and maintained the noise emission level does not require any special protection device to operate continuously close to the unit without any risk.

In cases where the installation is subject to compliance with special sound requirements, it may be necessary to use additional noise attenuation devices, it is necessary to isolate the unit from its base with extreme care, correctly applying the anti-vibration elements (supplied as optional). Flexible joints must be installed on the water connections, as well.

2.8 Water circuit for the connection of the unit

2.8.1 Water piping

Piping must be designed with the lowest number of elbows and the lowest number of vertical changes of direction. In this way, installation costs are reduced considerably, and system performance is improved.

The water system must have:

1. Anti-vibration mountings in order to reduce transmission of vibrations to the structures.
2. Isolating valves to isolate the unit from the water system during maintenance.
3. In order to protect the chiller, the evaporator/evaporators must be protected against freezing by continuous monitoring of the water flow in the evaporator/evaporators by a flow switch. In most cases, on site, the flow switch is set to generate an alarm only when the water pump turns off and the water flow drops to zero. It is recommended to adjust the flow switch in order to produce a "Water Leakage Alarm" when the water flow reaches 50% of the nominal value; in this case the evaporator/evaporators is/are protected against freezing and the flow switch can detect the clogging of the water filter.
4. Manual or automatic air venting device at the system highest point and drain device at the system lowest point.
5. Neither the evaporator nor the heat recovery device must be positioned at the system's highest point.
6. A suitable device that can maintain the water system under pressure (expansion tank, etc.).
7. Water temperature and pressure indicators to assist the operator during service and maintenance.
8. A filter or device that can remove particles from the fluid. The use of a filter extends the life of the evaporator and pump and helps to keep the water system in a better condition. **The water filter must be installed as close as possible to the chiller.** If the water filter is installed in another part of the water system, the Installer has to guarantee the cleaning of the water pipes between the water filter and the evaporator. If the unit has the full freecooling option, the filter must be installed in the common water pipe before the evaporators (see Fig. 15).

Recommended maximum opening for strainer mesh is:

- 0.87 mm (DX S&T)
- 1.0 mm (BPHE)
- 1.2 mm (Flooded)

In case of full freecooling option, consider the BPHE value (1.0 mm) for the maximum opening for strainer mesh.

9. Evaporator with an electrical resistance with a thermostat that ensures protection against water freezing at ambient temperatures as low as -18 °C.

All the other water piping/devices outside the unit must therefore be protected against freezing.

10. The heat recovery device must be emptied of water during the winter season, unless an ethylene glycol mixture in appropriate percentage is added to the water circuit.
11. In case of unit substitution, the entire water system must be emptied and cleaned before the new unit is installed. Regular tests and proper chemical treatment of water are recommended before starting up the new unit.

12. In the event that glycol is added to the water system as anti-freeze protection, pay attention to the fact that suction pressure will be lower, the unit performance will be lower and water pressure drops will be greater. All unit-protection systems, such as anti-freeze, and low-pressure protection will have to be readjusted.
13. Before insulating water piping, check that there are no leaks. The complete hydraulic circuit must be insulated to prevent condensation and reduced refrigeration capacity. Protect the water pipes from frost during winter (using for example a glycol solution or a heating cable).
14. Check that the water pressure does not exceed the design pressure of the water side heat exchangers. Install a safety valve on the water pipe downstream of the evaporator.
15. If the unit has the full freecooling option 172, the water piping must be designed as shown in Fig. 14, the entering and leaving water temperature probes must be installed in the common water pipe before the evaporators. The water butterfly valves must be automatic (electronic) and equipped by end position feedbacks, both must be connected to the unit control panel as showed in the wiring diagram. If the unit has the option 173 kit so the water piping is already mounted in the machine, with the water temperature probes, the water butterfly valves and the end position feedbacks. The water pump must be also connected to the unit control panel as showed in the wiring diagram.

2.8.2 Installing the flow switch

To ensure sufficient water flow through the evaporator, it is essential that a flow switch is installed on the water circuit. The flow switch can be installed either on the inlet or outlet water piping, but it is recommended on the outlet one. The purpose of the flow switch is to stop the unit in the event of interrupted water flow, thus protecting the evaporator from freezing.

The manufacturer offers, as optional, a flow switch that has been selected for this purpose.

This paddle-type flow switch is suitable for heavy-duty outdoor applications and pipe diameters in the range of 1" to 6".

The flow switch is supplied with a clean contact that must be electrically connected to the terminals shown in the wiring diagram.

The flow switch must be set up to intervene when the water flow of the evaporator reaches 50% of the nominal value.

If the unit has the full freecooling option, the flow switch must be installed in the common water pipe before the evaporators.

2.8.3 Heat recovery

Units may be optionally equipped with heat recovery system.

This system is made by a water-cooled heat exchanger located on the compressors discharge pipe and a dedicated management of condensing pressure.

To guarantee compressor operation within its envelope, units with heat recovery cannot operate with water temperature of the heat recovery water lower than 20 °C.

It is a responsibility of plant designer and chiller installer to guarantee the respect of this value (e.g. using recirculating bypass valve).

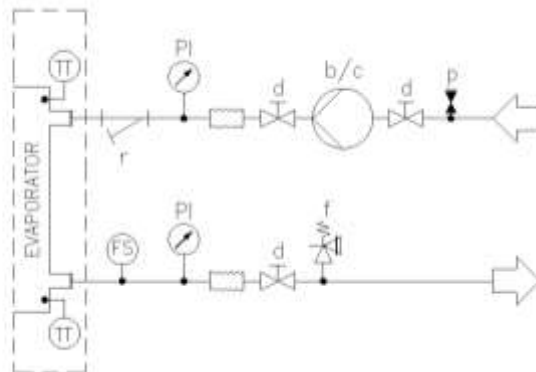

Fig. 5 – Hydraulic diagram without pump(s) on board (max. operating pressure 20 bar)

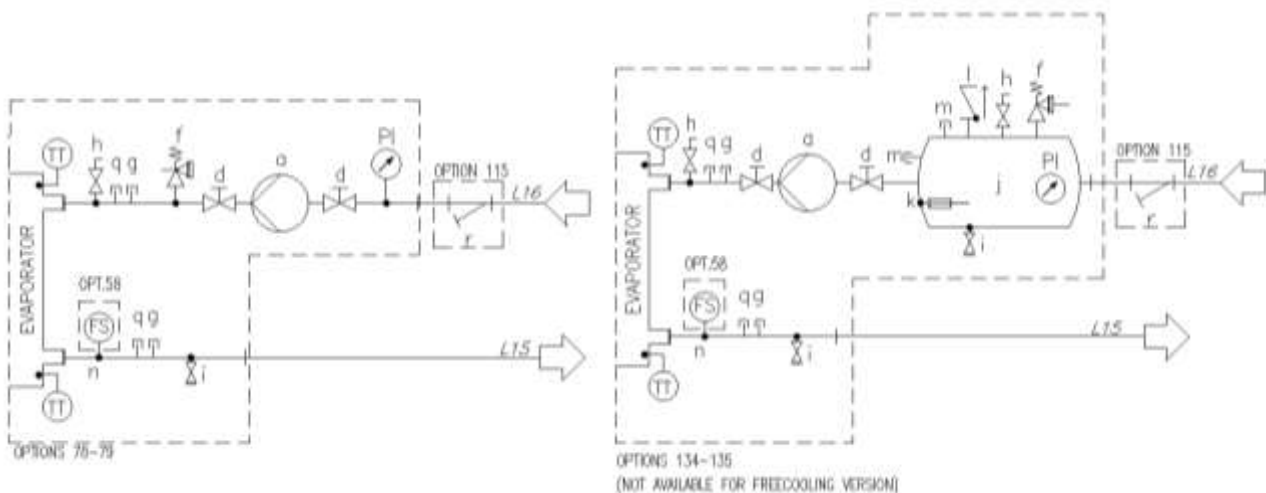

Fig. 6 – Hydraulic diagram for single V (EWATxx5B) single pump (opt. 78-79/134-135) (max. operating pressure 6 bar)

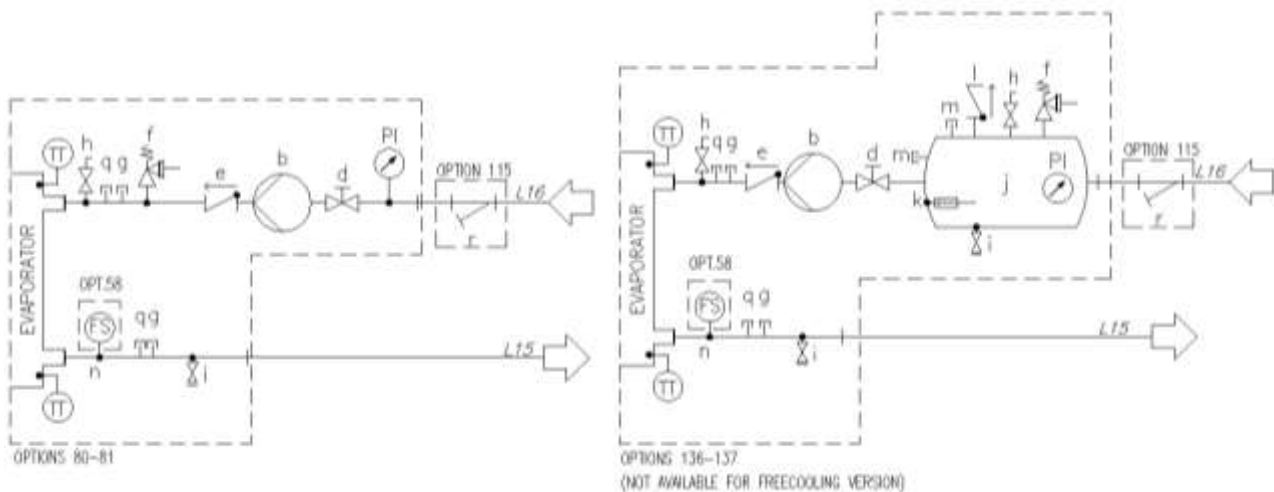

Fig. 7 – Hydraulic diagram for single V (EWATxx5B) double pump (opt. 80-81/136-137) (max. operating pressure 6 bar)

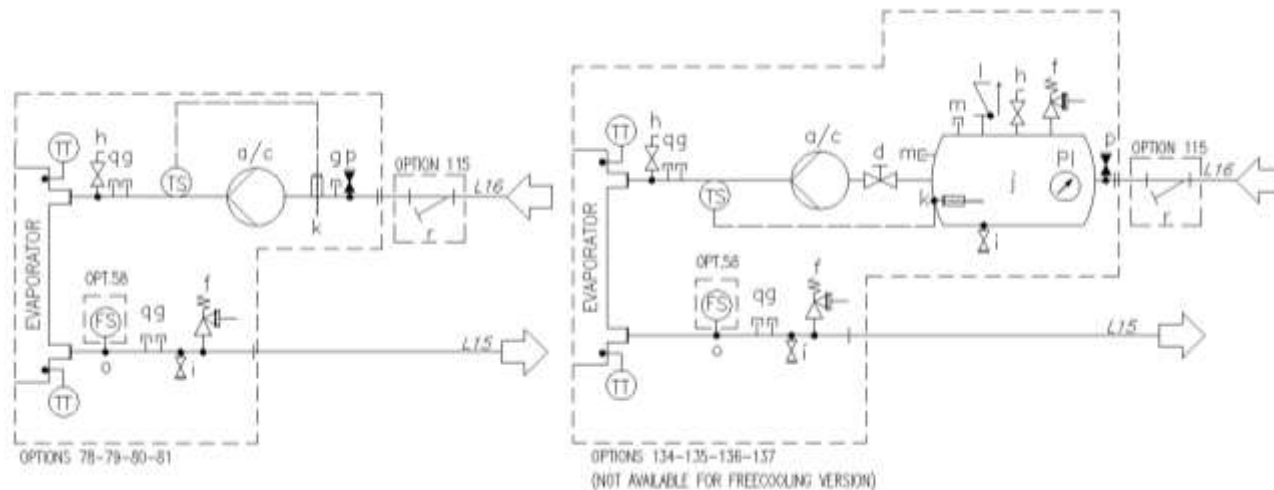

Fig. 8 – Hydraulic diagram for Modular V (EWATxx0B) (opt. 78-79-80-81/134-135-136-137) (max. operating pressure 6 bar)

Legend

a	Single Pump	l	Check valve
b	Two pumps- parallel configuration	m	Plugged fitting
c	Twin pump	n	Flow switch fitting 1”
d	Valve	o	Flow switch fitting ½ ”
e	Check Valve	p	Automatic filling valve fitting
f	Safety Valve	q	Plugged fitting
g	Plugged fitting	r	Water filter
h	Air vent	TT	Temperature sensor
i	Drain	TS	Temperature switch
j	Tank	PI	Pressure gauge
k	Electrical heater	FS	Flow switch

2.9 Water treatment

Before putting the unit into operation, clean the water circuit.

The evaporator/evaporators must not be exposed to flushing velocities or debris released during flushing. It is recommended that a suitably sized bypass and valve arrangement is installed to allow flushing of the piping system. The bypass can be used during maintenance to isolate the heat exchanger without disrupting flow to other units.

Any damage due to the presence of foreign bodies or debris in the evaporator will not be covered by warranty.

Dirt, scales, corrosion debris and other material can accumulate inside the heat exchanger and reduce its heat exchanging capacity. Pressure drop can increase as well, thus reducing water flow. Proper water treatment therefore reduces the risk of corrosion, erosion, scaling, etc. The most appropriate water treatment must be determined locally, according to the type of system and water characteristics.

The manufacturer is not responsible for damage to or malfunctioning of equipment caused by failure to treat water or by improperly treated water.

Table 1 – Acceptable water quality limits

DAE Water quality requirements	Shell&tube + Flooded	BPHE
Ph (25 °C)	6.8 ÷ 8.4	7.5 – 9.0
Electrical conductivity [$\mu\text{S}/\text{cm}$] (25 °C)	< 800	< 500
Chloride ion [$\text{mg Cl}^- / \text{l}$]	< 150	< 70 (HP ¹); < 300 (CO ²)
Sulphate ion [$\text{mg SO}_4^{2-} / \text{l}$]	< 100	< 100
Alkalinity [$\text{mg CaCO}_3 / \text{l}$]	< 100	< 200
Total Hardness [$\text{mg CaCO}_3 / \text{l}$]	< 200	75 ÷ 150
Iron [$\text{mg Fe} / \text{l}$]	< 1	< 0.2
Ammonium ion [$\text{mg NH}_4^+ / \text{l}$]	< 1	< 0.5
Silica [$\text{mg SiO}_2 / \text{l}$]	< 50	-
Chlorine molecular ($\text{mg Cl}_2/\text{l}$)	< 5	< 0.5

Note: 1: HP = Heat Pump
2: CO: Cooling Only

2.10 Operation limits

Operation out of the mentioned limits may damage the unit. In case of any doubt contact the manufacturer representative. To ensure correct operation of the unit, the value of the water flow in the evaporator must be within the declared range for that unit. A water flow rate much lower than the nominal value shown at the unit selection point can cause problems with freezing, fouling and poor control. A water flow much higher than the nominal value shown at the unit selection point results in an unacceptable loss of load and excessive erosion and vibration of the tubes which can cause them to break; **refer to the Chiller Selection Software (CSS) for the correct range of each unit.** For units with freecooling option, the freecooling mode can be active only when the ambient air temperature is at least 4 °C lower than the outlet water temperature.

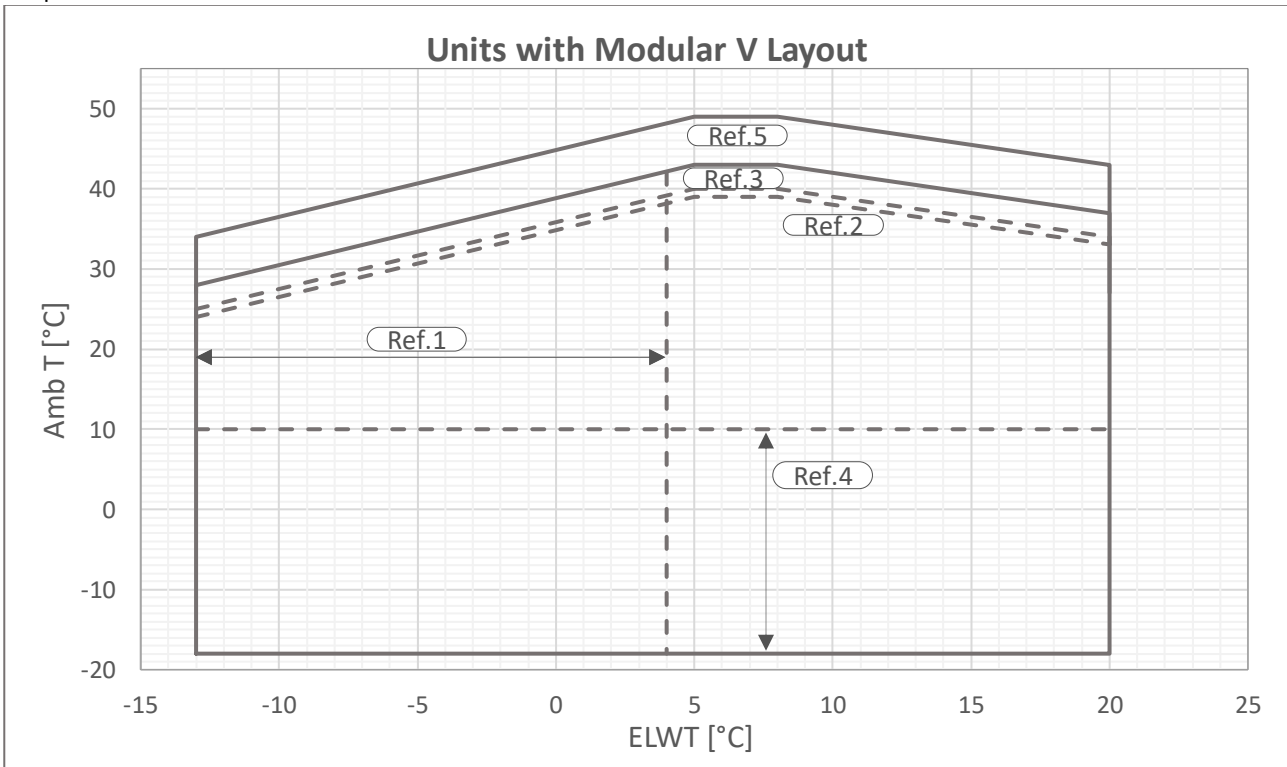

Fig. 9 – Multi V-Silver Operational limits

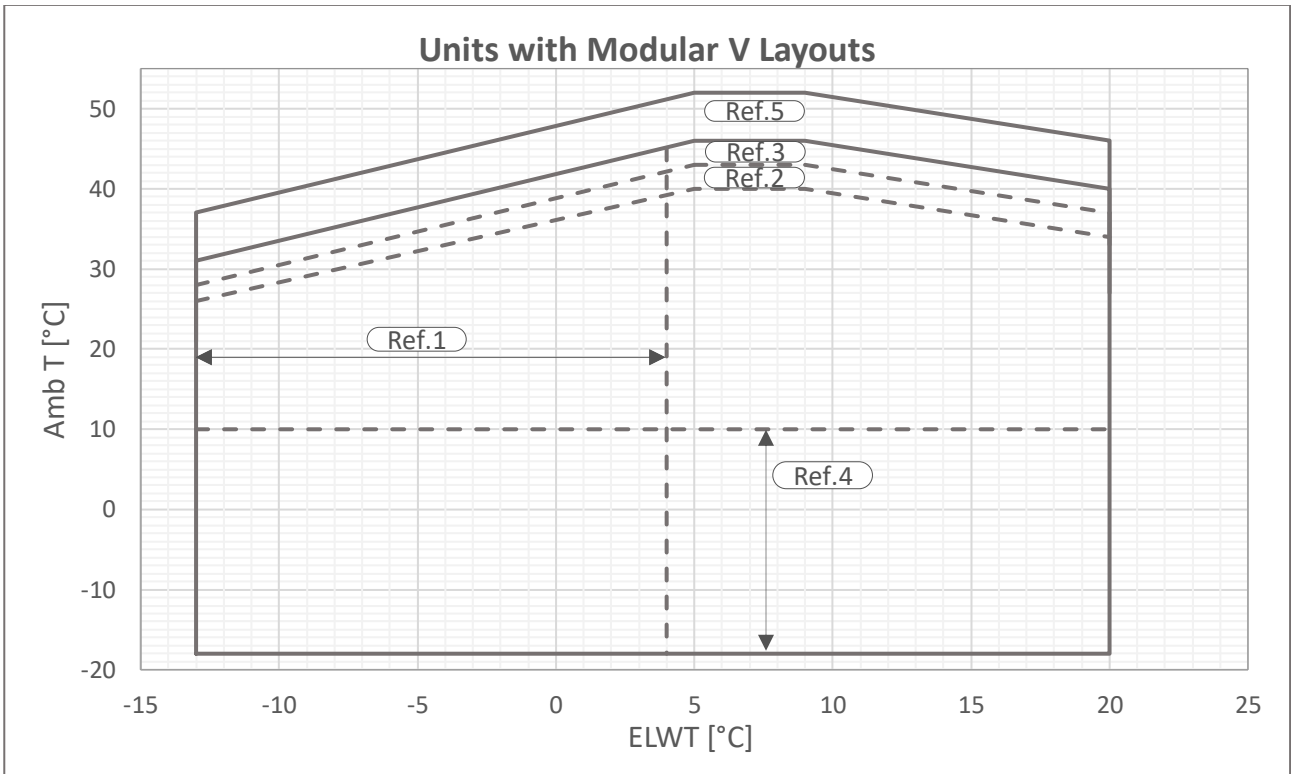

Fig. 10 – Multi V-Gold Operational limits

Amb T	Ambient air temperature
ELWT	Evaporator leaving water temperature
Ref 1	Operation with ELWT <4 °C requires option 08 (brine) and glycol
Ref 2	Operation at ambient temperatures <10 °C requires option 99 (fan speed modulation) or option 42 (Speedtroll)
Ref 3	Units with the "Reduced noise" configuration can increase the sound level in this area
Ref 4	Partial load operation; operation at full load may require option 142 (High ambient temperature kit)

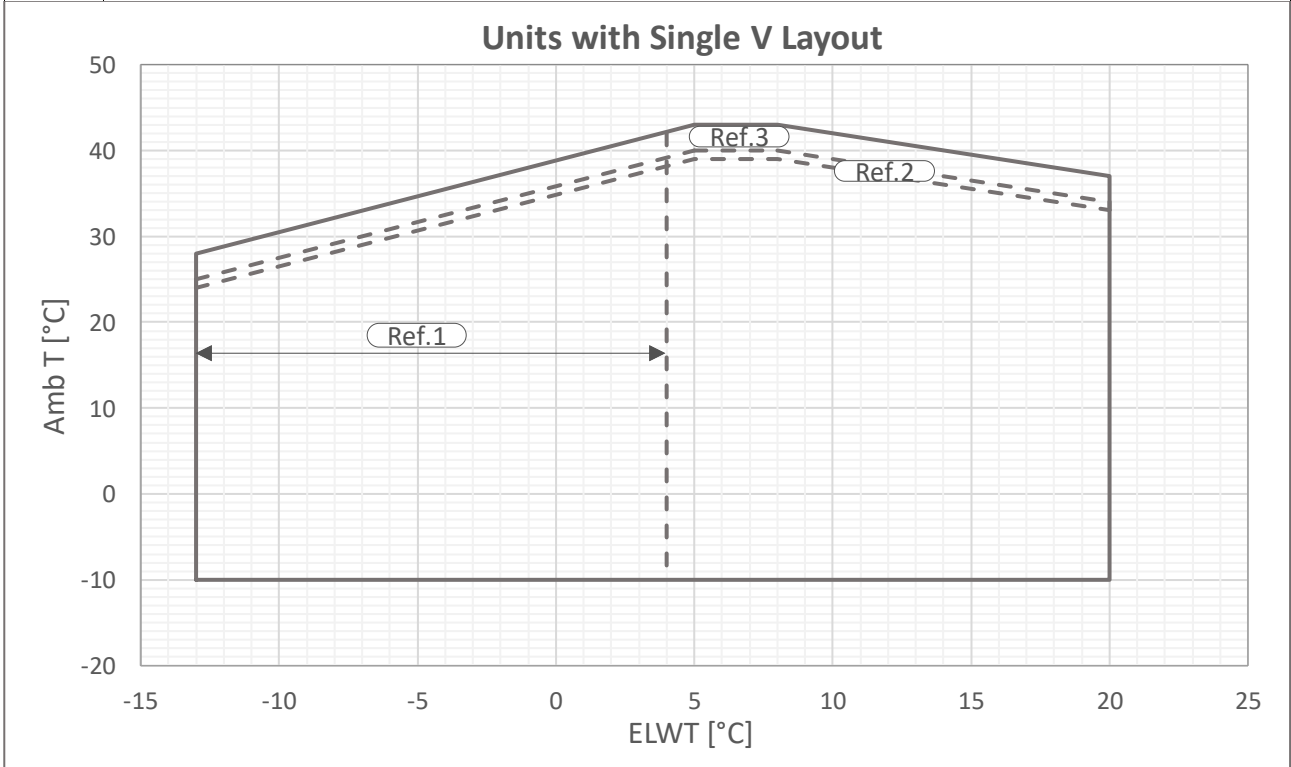

Fig. 11 – Single V-Silver Operational limits

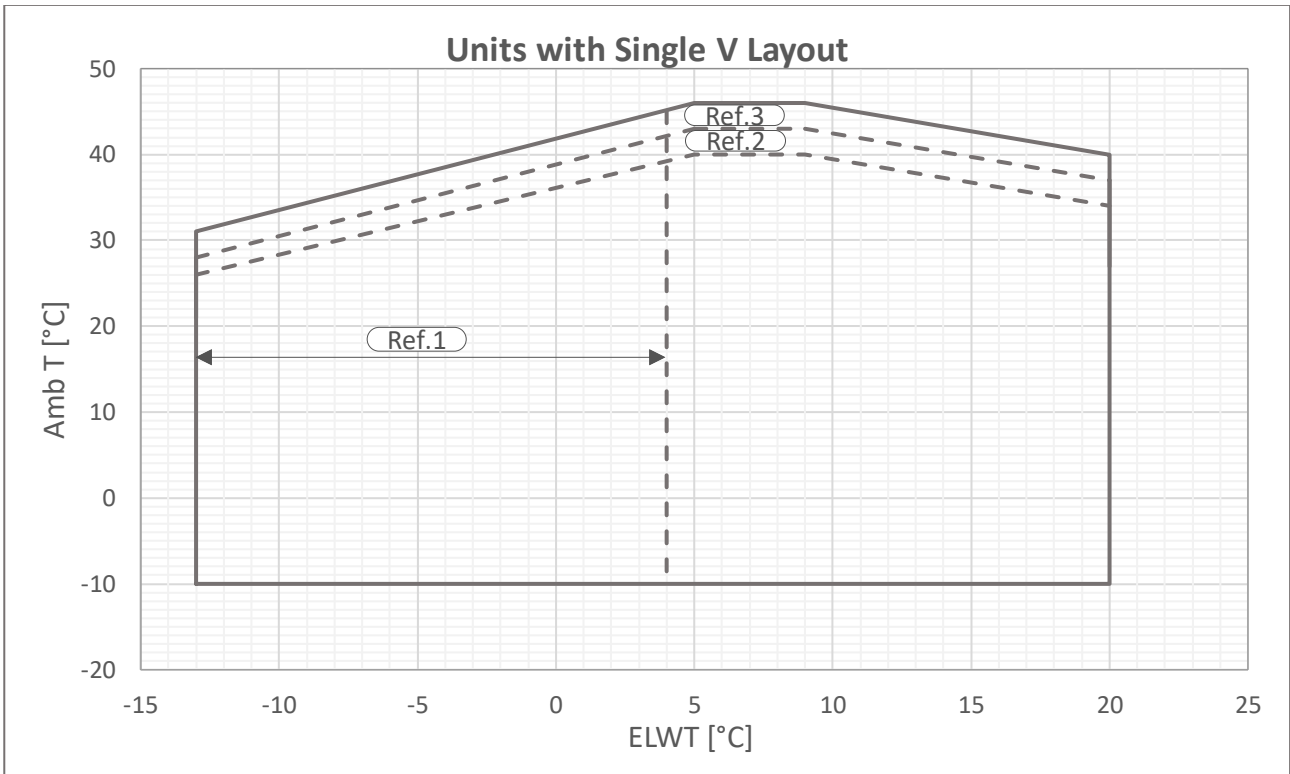

Fig. 12 – Single V-Gold Operational limits

Amb T	Ambient air temperature
ELWT	Evaporator leaving water temperature
Ref 1	Operation with ELWT <4 ° C requires option 08 (brine) and glycol
Ref 2	Operation at ambient temperatures <10 ° C requires option 99 (fan speed modulation) or option 42 (Speedroll)
Ref 3	Partial load operation; operation at full load may require option 142 (High ambient temperature kit)



The charts shown above constitute a guideline on operating limits in the range.
Refer to the CSS selection software for the actual operating limits in the working conditions for each model.

Table 2 – Evaporator - Fouling factor

A	B	C	D
0.0176	1.000	1.000	1.000
0.0440	0.978	0.986	0.992
0.0880	0.957	0.974	0.983
0.1320	0.938	0.962	0.975

Legend:

- A = Fouling factor (m² °C / kW)
- B = Correction factor of the cooling capacity
- C = Correction factor of the absorbed power
- D = EER correction factor

Table 3 – Air heat exchanger - Altitude correction factor

A	0	300	600	900	1200	1500	1800
B	1013	977	942	908	875	843	812
C	1.000	0.993	0.986	0.979	0.973	0.967	0.960
D	1.000	1.005	1.009	1.015	1.021	1.026	1.031

Legend:

- A = Altitude above sea level (m)
- B = Barometric pressure (mbar)
- C = Correction factor of the cooling capacity
- D = Correction factor of the absorbed power
- The maximum operating altitude is 2000 m above sea level.

- Contact the factory if the unit is to be installed at altitudes between 1000 and 2000 m above sea level.

Table 4 – Minimum percentage of glycol for the low air ambient temperature

	AAT (2)	-3	-8	-15	-20
A (1)		10%	20%	30%	40%
	AAT (2)	-3	-7	-12	-20
B (1)		10%	20%	30%	40%

Legend:

AAT = Ambient air temperature (°C) (2)

A = Ethylene glycol (%) (1)

B = Propylene glycol (%) (1)

(1) Minimum percentage of glycol to prevent freezing of the water circuit at the indicated ambient air temperature

(2) Ambient air temperature that exceeds the operating limits of the unit.

Protection of the water circuit is necessary in the winter season, even with the unit not in operation.

2.11 Operating stability and minimum water content in the system

For the correct functioning of the machine it is important to guarantee a minimum water content inside the system, avoiding an excessive number of compressor start-ups and stops. In fact, every time the compressor starts working, an excessive amount of oil from the compressor enters the circulation in the refrigerant circuit and at the same time there is an increase in the temperature of the compressor stator, generated by the inrush current of the starting. In order to avoid damage to the compressors, the control system allows no more than 10 starts per hour. The plant where the unit is installed must therefore ensure that the overall water content allows constant operation of the unit and consequently also greater environmental comfort.

The minimum water content per unit can be calculated with a certain approximation using the following formula must be calculated considering the following specifications:

$$M [l] = m \left[\frac{l}{kW} \right] * CC [kW]$$

where:

M = minimum water content per unit, expressed in liters [l];

CC = cooling capacity (Cooling Capacity), expressed in kiloWatt [kW];

m = specific water content [l/kW].

Model	m
EWATxxxB-XXA1	5 l/kW
EWATxxxB-XXA2	2.5 l/kW

Note: The calculation formula described above takes into account several factors such as the compressor stop time and the permissible temperature difference between turning off and restarting the last compressor. In this regard, the minimum calculated water content refers to the operation of the machine in a normal air conditioning system. If greater stability of operation is required, it is recommended to double the calculated water content. For the most accurate determination of the amount of water, it is advisable to contact the system designer. In very simple systems, it may be necessary to insert in the hydraulic circuit an inertial storage tank that allows to reach the minimum volume of water required. The insertion of this component must guarantee the correct mixing of the water and therefore it is advisable to choose a tank that has inside of the diaphragms dedicated for this purpose.

2.12 Anti-freeze protection for evaporator and recovery exchangers

All evaporators are supplied with a thermostatically controlled anti-freeze electrical resistance, which provides adequate anti-freeze protection at temperatures as low as -18 °C.

However, unless the heat exchangers are completely empty and cleaned with anti-freeze solution, additional methods should also be used against freezing.

Two or more of below protection methods should be considered when designing the system as a whole:

- continuous water flow circulation inside piping and exchangers;
- addition of an appropriate amount of glycol inside the water circuit;
- additional heat insulation and heating of exposed piping;
- if the unit does not work during the winter season, emptying and cleaning of the heat exchanger.

It is the responsibility of the installer and/or of local maintenance personnel to ensure that described anti-freeze methods are used. Make sure that appropriate anti-freeze protection is maintained at all times. Failing to follow the instructions above could result in unit damage.



Damage caused by freezing is excluded from the warranty, therefore Daikin Applied Europe S.p.A declines all responsibility

2.13 Electric connections

Provide an electrical circuit to connect the unit. It must be connected to the copper cables with an adequate section relative to the plate absorption values and according to the current electrical standards.

Daikin Applied Europe S.p.A. declines all responsibility for an inadequate electrical connection.



The connections to the terminals must be made with copper terminals and cables, otherwise overheating or corrosion may occur at the connection points with the risk of damaging the unit. The electrical connection must be carried out by qualified personnel, in compliance with the laws in force. There is a risk of electric shock.

The power supply to the unit must be set up in such a way that it can be switched on or off independently from that of other system components and other equipment in general, by means of a general switch.

The electrical connection of the panel must be carried out maintaining the correct sequence of the phases. Refer to the specific wiring diagram for the unit you have bought. Should the wiring diagram not be on the unit or should it have been lost, please contact your manufacturer representative, who will send you a copy. In case of discrepancy between wiring diagram and electrical panel/cables, please contact the manufacturer representative.



Do not apply torque, tension or weight to the main switch terminals. Power line cables must be supported by appropriate systems.

To avoid interference, all control wires must be connected separately from the power cables. To do this, use several electrical passage ducts.

Simultaneous single and three-phase loads and phase unbalance can cause ground losses of up to 150 mA during normal unit operation. If the unit includes devices that generate higher harmonics, such as an inverter or phase cut, ground losses can increase to much higher values, about 2 A.

The protections for the power supply system must be designed according to the values mentioned above. A fuse must be present on each phase and, where provided for by the national laws of the country of installation, a leak detector to earth. This product complies with EMC (Electromagnetic Compatibility) standards for industrial environments. Therefore it is not intended for use in residential areas, e.g. installations where the product is connected to a low voltage public distribution system. Should this product need to be connected to a low voltage public distribution system, specific additional measures will have to be taken to avoid interference with other sensitive equipment.



Before any electrical connection work to the compressor motor and / or the fans, make sure that the system is switched off and the main switch of the unit is open. Failure to observe this rule could result in serious personal injury.

2.13.1 Cable requirements

The cables connected to the circuit breaker must respect the insulation distance in the air and the surface isolation distance between the active conductors and the earth, according to IEC 61439-1 table 1 and 2, and to the local national laws. The cables connected to the main switch must be tightened using a pair of keys and respecting the unified clamping values, relative to the quality of the screws of the washers and nuts used.

Connect the earth conductor (yellow / green) to the PE ground terminal.

The equipotential protection conductor (earth conductor) must have a section according to table 1 of EN 60204-1 Point 5.2, shown below.

In any case, the equipotential protection conductor (earth conductor) must have a cross section of at least 10 mm², in accordance with point 8.2.8 of the same standard.

2.14 Phase unbalance

In a three-phase system, the excessive imbalance between the phases is the cause of the engine overheating. The maximum permitted voltage unbalance is 3%, calculated as follows:

$$\text{Unbalance \%} = \frac{(V_x - V_m) * 100}{V_m}$$

where:

V_x = phase with greater unbalance

V_m = average of the tensions

Example: the three phases measure 383, 386 and 392 V respectively. The average is:

$$\frac{383 + 386 + 392}{3} = 387 \text{ V}$$

The unbalance percentage is:

$$\frac{(392 - 387) * 100}{387} = 1.29 \%$$

less than the maximum allowed (3%).

3 OPERATOR'S RESPONSIBILITIES

It is essential that the operator is appropriately trained and becomes familiar with the system before operating the unit. In addition to reading this manual, the operator must study the microprocessor operating manual and the wiring diagram in order to understand start-up sequence, operation, shutdown sequence and operation of all the safety devices.

During the unit initial start-up phase, a technician authorized by the manufacturer is available to answer any questions and to give instructions as to the correct operating procedures.

The operator must keep a record of operating data for every installed unit. Another registration must also be kept for all the periodic maintenance and assistance activities.

If the operator notes abnormal or unusual operating conditions, he is advised to consult the technical service authorized by the manufacturer.



If the unit is switched off, the compressor heating resistors cannot be used. Once the unit is reconnected to the mains, leave the compressor heating resistors charged for at least 12 hours before restarting the unit.

Failure to observe this rule may cause damage to the compressors due to excessive accumulation of liquid inside them.

This unit represents a substantial investment and deserves the attention and care to keep this equipment in good working order.

However, during operation and maintenance it is essential to observe the following instructions:

- do not allow unauthorized and / or unqualified personnel to access the unit;
- it is forbidden to access the electrical components without having opened the unit main switch and switched off the power supply;
- it is forbidden to access the electrical components without using an insulating platform. Do not access the electrical components if water and/or moisture are present;
- verify that all operations on the refrigerant circuit and on the components under pressure are carried out exclusively by qualified personnel;
- the replacement of the compressors must be carried out exclusively by qualified personnel;
- sharp edges and the surface of the condenser section could cause injury. Avoid direct contact and use adequate protection device;
- do not introduce solid objects into the water pipes while the unit is connected to the system;
- it is absolutely forbidden to remove all protections of moving parts.

In case of sudden stop of the unit, follow the instructions on the Control Panel Operating Manual which is part of the on-board documentation delivered to the end user.

It is strongly recommended to perform installation and maintenance with other people.

In case of accidental injury or unease, it is necessary to:

- keep calm;
- press the alarm button if present in the installation site;
- contact immediately emergency rescue personnel of the building or the Health Emergency Service;
- wait for the operators to arrive without leaving the injured person alone;
- give all necessary information to the rescue operators.



Avoid installing the chiller in areas that could be dangerous during maintenance operations, such as platforms without parapets or railings or areas not complying with the clearance requirements around the chiller.

4 MAINTENANCE

Personnel working on the electrical or the refrigeration components must be authorized, trained and fully qualified. Maintenance and repair requiring the assistance of other skilled personnel should be carried out under the supervision of the person competent in the use of flammable refrigerants. Any person conducting servicing or maintenance on a system or associated parts of the equipment should be competent according to EN 13313.

Persons working on refrigerating systems with flammable refrigerants should have competence in safety aspects of flammable refrigerant handling supported by evidence of appropriate training.

Always protect the operating personnel with personal protective equipment appropriate for the tasks to be performed. Common individual devices are: helmet, goggles, gloves, caps, safety shoes. Additional individual and group protective equipment should be adopted after an adequate analysis of the specific risks in the area of relevance, according to the activities to be performed.

electrical components	Never work on any electrical components, until the general supply to the unit has been cut using the disconnect switch(es) in the control box. The frequency variators used are equipped with capacitor batteries with a discharge time of 20 minutes; after disconnecting power wait 20 minutes before opening the control box.
refrigerating system	<p>The following precautions should be taken before working on the refrigerant circuit:</p> <ul style="list-style-type: none"> — obtain permit for hot work (if required); — ensure that no flammable materials are stored in the work area and that no ignition sources are present anywhere in the work area; — ensure that suitable fire extinguishing equipment is available; — ensure that the work area is properly ventilated before working on the refrigerant circuit or before welding, brazing or soldering work; — ensure that the leak detection equipment being used is non-sparking, adequately sealed or intrinsically safe; — ensure that all maintenance staff have been instructed. <p>The following procedure should be followed before working on the refrigerant circuit:</p> <p>remove refrigerant (specify the residual pressure); purge circuit with inert gas (e.g. nitrogen); evacuate to a pressure of 0,3 (abs.) bar (or 0,03 MPa); purge again with inert gas (e.g. nitrogen); open the circuit.</p> <p>The area should be checked with an appropriate refrigerant detector prior to and during any hot work to make the technician aware of a potentially flammable atmosphere.</p> <p>If compressors or compressor oils are to be removed, it should be ensured that it has been evacuated to an acceptable level to ensure that there is no flammable refrigerant remaining within the lubricant.</p> <p>Only refrigerant recovery equipment designed for use with flammable refrigerants should be employed.</p> <p>If the national rules or regulations permit the refrigerant to be drained, this should be done safely, using a hose, for example, through which the refrigerant is discharged into the outside atmosphere in a safe area. It should be ensured that an inflammable explosive refrigerant concentration cannot occur in the vicinity of an ignition source or penetrate into a building under any circumstance.</p> <p>In the case of refrigerating systems with an indirect system, the heat-transfer fluid should be checked for the possible presence of refrigerant.</p> <p>After any repair work, the safety devices, for example refrigerant detectors and mechanical ventilation systems, should be checked and the results recorded.</p> <p>It should be ensured that any missing or illegible label on components of the refrigerant circuit is replaced.</p> <p>Sources of ignition should not be used when searching for a refrigerant leak.</p>

4.1 Pressure / temperature table

Table 5 – Pressure / Temperature of the R32

°C	Bar	°C	Bar	°C	Bar	°C	Bar
-28	2.97	-2	7.62	24	16.45	50	31.41
-26	3.22	0	8.13	26	17.35	52	32.89
-24	3.48	2	8.67	28	18.30	54	34.42
-22	3.76	4	9.23	30	19.28	56	36.00
-20	4.06	6	9.81	32	20.29	58	37.64
-18	4.37	8	10.43	34	21.35	60	39.33

-16	4.71	10	11.07	36	22.45	62	41.09
-14	5.06	12	11.74	38	23.60	64	42.91
-12	5.43	14	12.45	40	24.78	66	44.79
-10	5.83	16	13.18	42	26.01	68	46.75
-8	6.24	18	13.95	44	27.29	70	48.77
-6	6.68	20	14.75	46	28.61	72	50.87
-4	7.14	22	15.58	48	29.99	74	53.05

4.2 Routine maintenance

This chiller must be maintained by qualified technicians. Before beginning any work on the system, the personnel shall assure that all security precautions have been taken.

Neglecting unit maintenance could degrade all parts of the units (coils, compressors, frames, pipes, etc.) with negative effect on performances and functionality.



Shut-off valves must be turned at least once a year in order to preserve their function.

There are two different levels of maintenance, which can be chosen according to the type of application (critical/non critical) or to the installation environment (highly aggressive).

Examples of critical applications are process cooling, data centers, etc.

Highly Aggressive Environments can be defined as the follows:

- Industrial environment (with possible concentration of fumes result of combustion and chemical process);
- Coastal environment;
- Highly polluted urban environment;
- Rural environment close to animal excrement and fertilizers, and high concentration of exhaust gas from diesel generators;
- Desert areas with risk of sandstorms;
- Combinations of the above.

Table 7 lists all Maintenance activities for standard applications and standard environment.

Table 8 lists all Maintenance activities for critical applications or highly aggressive environment.

Unit exposed to a highly aggressive environment can face corrosion in a shorter time than the ones installed on a standard environment. Corrosion causes a rapid rusting of the frame core, consequently decreases unit structure life time. To avoid that, it is necessary to wash periodically the frame surfaces with water and suitable detergents.

In case of part of unit frame paint came off, it is important to stop its progressive deterioration by repainting the exposed parts using proper products. Please contact factory to get the required products specifications.

In case of just salt deposits are present, it is enough to rinse the parts with fresh water.

4.2.1 Microchannel Air Condenser Maintenance

Routine cleaning of air condenser surfaces is essential to maintain proper operation of the unit, avoid corrosion and rusting. Elimination of contamination and removal of harmful residues will greatly increase the life of the coil and extend the life of the unit.

Relative to fin and tube heat exchangers, microchannel coils tend to accumulate more of the dirt on the surface and of the less dirt inside which can make them easier to clean.

The following maintenance and cleaning procedure are recommended as part of the routine maintenance activities:

1. Remove surface dirt, leaves, fibers, etc. with a vacuum cleaner (preferably with a brush or other soft attachment rather than a metal tube), compressed air blown from the inside out, and/or a soft bristle (not wire!) brush. Do not impact or scrape the coil with the vacuum tube, air nozzle, etc.

Note: Use of a water stream, such as a garden hose, against a surface loaded coil will drive the fibers and dirt into the coil. This will make cleaning efforts more difficult. Surface loaded fibers must be completely removed prior to using low velocity clean water rinse.

2. Rinse. Do not use any chemicals (including those advertised as coil cleaners) to wash microchannel heat exchangers. They can cause corrosion. Rinse only. Hose the MCHE off gently, preferably from the inside out and top to bottom, running the water through every fin passage until it comes out clean. Microchannels fins are stronger than traditional tube & fin coil fins but still need to be handled with care.
It is possible to clean a coil with a high pressure washer (max 62 barg) only if a flat shape of the water spray is used and direction of the spay is kept perpendicular to the fin edge. **If this direction is not respected the coil may be destroyed** if using a pressure washer so we do not recommend their use.
-

Note: A monthly clean water rinse is recommended for coils that are applied in coastal or industrial environments to help to remove chlorides, dirt and debris. It is very important when rinsing, that the water temperature is less than 55 °C. An elevated water temperature (not to exceed 55 °C) will reduce surface tension, increasing the ability to remove chlorides and dirt.

- Quarterly cleaning is essential to extend the life of an E-coated coil and is required to maintain warranty coverage. Failure to clean an E-coated coil will void the warranty and may result in reduced efficiency and durability in the environment. For routine quarterly cleaning, first clean the coil with an approved coil cleaner. After cleaning the coils with the approved cleaning agent, use the approved chloride remover to remove soluble salts and revitalize the unit.

Note: Harsh chemicals, household bleach or acid cleaners should not be used to clean E-coated coils. These cleaners can be very difficult to rinse out of the coil and can accelerate corrosion and attack the E-coating. If there is dirt below the surface of the coil, use the recommended coil cleaners as described above.

Galvanic corrosion of the connection Copper/Aluminum can occur in corrosive atmosphere under the plastic protection; during the maintenance operations or periodic cleaning, check the aspect of the plastic protection of the copper/aluminum connection. If it is inflated, damaged or took off contact the manufacturer representative for advice and information.

4.2.2 Electrical Installation



All electrical maintenance activities must be followed by qualified personnel. Make sure the system is switched off and the main switch of the unit open. Failure to observe this rule could result in serious personal injury. When the unit is turned off but the disconnection switch is in the closed position, the unused circuits will still be active.

The maintenance of the electrical system consists of the application of some general rules as follows:

- the current absorbed by the compressor must be compared to the rated value. Normally the value of the absorbed current is lower than the rated value that corresponds to the absorption of the full load compressor at the maximum operating conditions;
- at least once every three months all the security checks must be made to verify their functionality. Each appliance, with aging, can change its point of operation and this must be monitored in order to adjust it or replace it. The pump interlocks and flow switches must be checked to make sure that they interrupt the control circuit if they intervene.

4.2.3 Service and limited warranty

All units are factory-tested and guaranteed for 12 months as of the first start-up or 18 months as of delivery.

These units have been developed and constructed according to high quality standards ensuring years of failure-free operation. **However, the unit requires maintenance even during the warranty period, from the time of installation and not just from the commissioning date.** We strongly advise stipulating a maintenance contract with a service authorized by the manufacturer in order to ensure efficient and problem-free service, thanks to the expertise and experience of our personnel.

It must be borne in mind that operating the unit in an inappropriate manner, beyond its operating limits or not performing proper maintenance according to this manual can void the warranty.

Observe the following points in particular, in order to conform to warranty limits:

- The unit cannot function beyond the specified limits;
- The electrical power supply must be within the voltage limits and without voltage harmonics or sudden changes;
- The three-phase power supply must not have an unbalance between phases exceeding 3%. The unit must stay turned off until the electrical problem has been solved;
- No safety device, either mechanical, electrical or electronic must be disabled or overridden;
- The water used for filling the water circuit must be clean and suitably treated. A mechanical filter must be installed at the point closest to the evaporator inlet, if the unit is provided with the full freecooling option the mechanical filter must be installed in the common water pipe before the evaporators;
- the value of the evaporator water flow must be included in the declared range for the unit considered, refer to the CSS selection software.

Table 6 – Standard Routine Maintenance Plan

List of Activities	Weekly	Monthly (Note 1)	Annual/Seasonal (Note 2)
General:			
Reading of operating data (Note 3)	X		
Visual inspection of unit for any damage and/or loosening		X	
Verification of thermal insulation integrity			X
Clean and paint where necessary			X
Analysis of water (4)			X
Check of flow switch operation		X	
Electrical Installation:			
Verification of control sequence			X
Verify contactor wear – Replace if necessary			X
Verify that all electrical terminals are tight – Tighten if necessary			X
Clean inside the electrical control board			X
Visual inspection of components for any signs of overheating		X	
Verify operation of compressor and electrical resistance		X	
Measure compressor motor insulation using the Megger			X
Clean air intake filters of the electrical panel		X	
Verify operation of the ventilation system in the electrical panel			X
Refrigeration circuit:			

Check for any refrigerant leakage (leak test)		X	
Verify refrigerant flow using the liquid sight glass – Sight glass full	X		
Verify filter dryer pressure drop		X	
Analyse compressor vibrations			X
Analyse compressor oil acidity (Note 7)			X
Check the security valve (Note 5)		X	
Condenser section:			
Check the cleaning of condensing coils and water heat exchangers (Note 6)			X
Verify that fans are well tightened			X
Verify the condenser coil fins - Remove if necessary			X
Evaporator/evaporators:			
Check the cleaning of the BPHE and, in case of full freecooling option, the tubes of the shell & tube heat exchangers (Note 6)			X

Notes:

1. Monthly activities include all the weekly ones.
2. The annual (or early season) activities include all weekly and monthly activities.
3. Daily reading of the operating values of the unit allows maintaining high observational standards.
4. Check for any dissolved metals.
5. Check that the cap and the seal have not been tampered with. Check that the drainage connection of the safety valves is not accidentally occluded by foreign objects, rust or ice. Check the manufacturing date on the safety valve and replace it, if necessary, in compliance with the national laws in force.
6. Clean condenser banks with clean water and water heat exchangers with appropriate chemicals. Particles and fibers could clog up the exchangers, especially for water exchangers pay attention if water rich in calcium carbonate is used. An increase in pressure drops or a decrease in thermal efficiency means that the heat exchangers are clogged. In environments with a high concentration of air-borne particles, it might be necessary to clean the condenser bank more often.
7. TAN (Total acid number):
 - ≤ 0.10: No action
 - Between 0.10 and 0.19: Replace anti-acid filters and re-check after 1000 running hours. Continue to replace the filters until the TAN is below 0.10.
 - > 0.19: replace oil, oil filter and oil filter dryer. Verify at regular intervals.
8. Units placed or stored in a Highly Aggressive Environment for long time without operation are still subject to those routine maintenance steps.

Table 7 – Routine Maintenance Plan for Critical Application and/or Highly Aggressive Environment

List of Activities (Note 8)	Weekly	Monthly (Note 1)	Yearly/Seasonal (Note 2)
General:			
Reading of operating data (Note 3)	X		
Visual inspection of unit for any damage and/or loosening		X	
Verification of thermal insulation integrity			X
Cleaning		X	
Paint where necessary			X
Analysis of water (4)			X
Check of flow switch operation		X	
Electrical Installation:			
Verification of control sequence			X
Verify contactor wear – Replace if necessary			X
Verify that all electrical terminals are tight – Tighten if necessary			X
Clean inside the electrical control board		X	
Visual inspection of components for any signs of overheating		X	
Verify operation of compressor and electrical resistance		X	
Measure compressor motor insulation using the Megger			X
Clean air intake filters of the electrical panel		X	
Verify operation of all ventilation fans in the electrical panel			X
Refrigeration circuit:			
Check for any refrigerant leakage (leak test)		X	
Verify refrigerant flow using the liquid sight glass – Sight glass full	X		
Verify filter dryer pressure drop		X	
Analyse compressor vibrations			X
Analyse compressor oil acidity (Note 7)			X
Check the security valve (Note 5)		X	
Condenser section:			
Checking the cleaning of the air-cooler (Note 6)		X	
Check the cleaning of water heat exchangers (Note 6)			X
Quarterly clean condenser coils (E-coated only)			X
Verify that fans are well tightened			X
Verify condenser coil fins – Comb if necessary		X	
Check the aspect of the plastic protection of the copper/aluminum connection		X	
Evaporator/evaporators:			
Check the cleaning of the BPHE and, in case of full freecooling option, the tubes of the shell & tube heat exchangers (Note 6)			X

Notes:

8. Monthly activities include all the weekly ones.
9. The annual (or early season) activities include all weekly and monthly activities.
10. Daily reading of the operating values of the unit allows maintaining high observational standards.
11. Check for any dissolved metals.
12. Check that the cap and the seal have not been tampered with. Check that the drainage connection of the safety valves is not accidentally occluded by foreign objects, rust, or ice. Check the manufacturing date on the safety valve and replace it, if necessary, in compliance with the national laws in force.
13. Clean condenser banks with clean water and water heat exchangers with appropriate chemicals. Particles and fibers could clog up the exchangers, especially for water exchangers pay attention if water rich in calcium carbonate is used. An increase in pressure drops or a decrease in thermal efficiency means that the heat exchangers are clogged. In environments with a high concentration of air-borne particles, it might be necessary to clean the condenser bank more often.
14. TAN (Total acid number):
 - ≤ 0.10: No action
 - Between 0.10 and 0.19: Replace anti-acid filters and re-check after 1000 running hours. Continue to replace the filters until the TAN is below 0.10.
 - > 0.19: replace oil, oil filter and oil filter dryer. Verify at regular intervals.
9. Units placed or stored in a Highly Aggressive Environment for long time without operation are still subject to those routine maintenance steps.

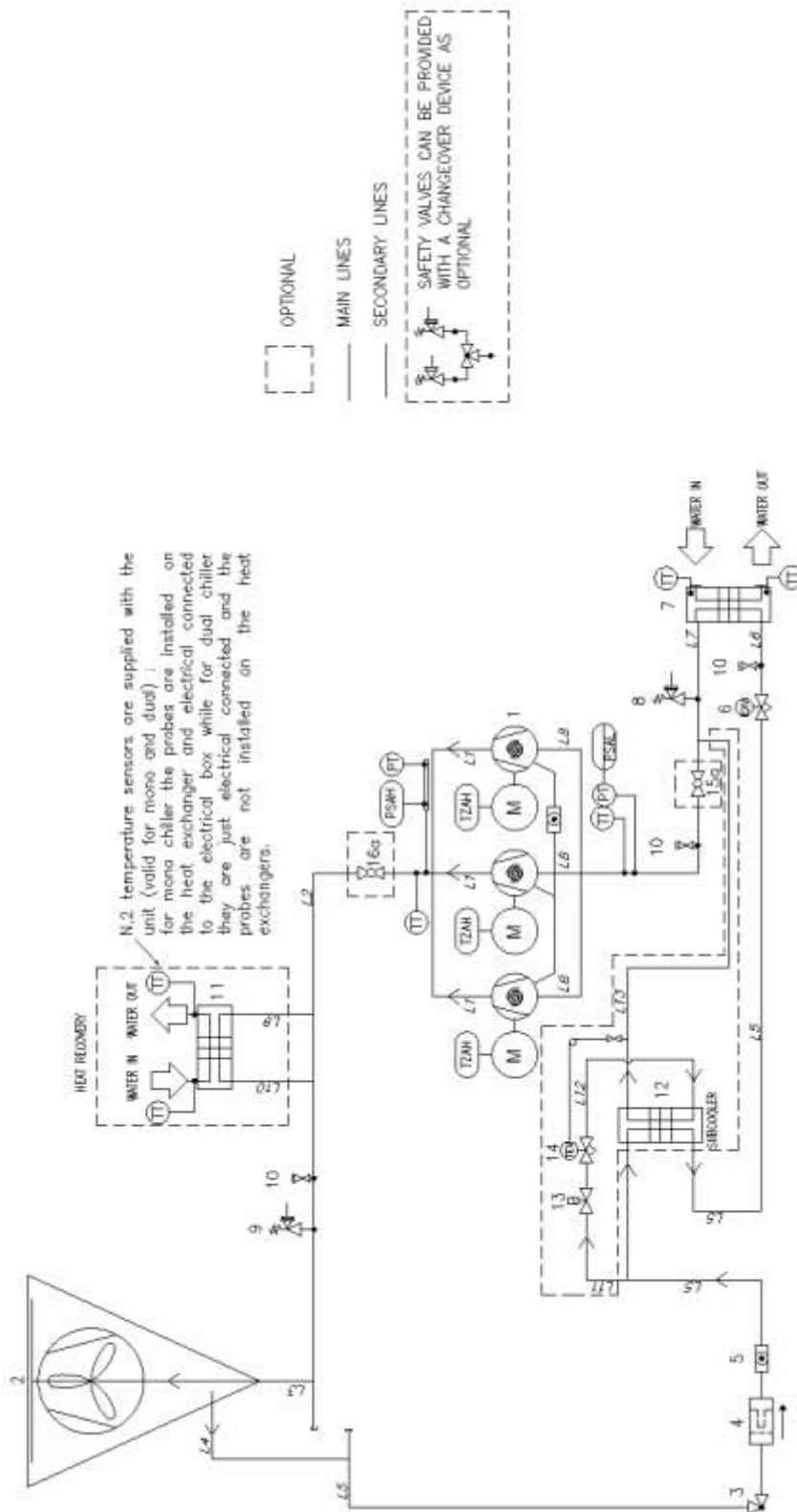

Fig. 13 – Refrigerant circuit diagram (P&ID) standard single circuit unit

Water inlet and outlet are indicative. Please refer to the machine dimensional diagrams for exact water connections. The series is composed by mono (one circuit) and dual (two circuits) chiller. Each circuit can be with 3 or 2 compressor (tandem configuration). Only one circuit is reported.

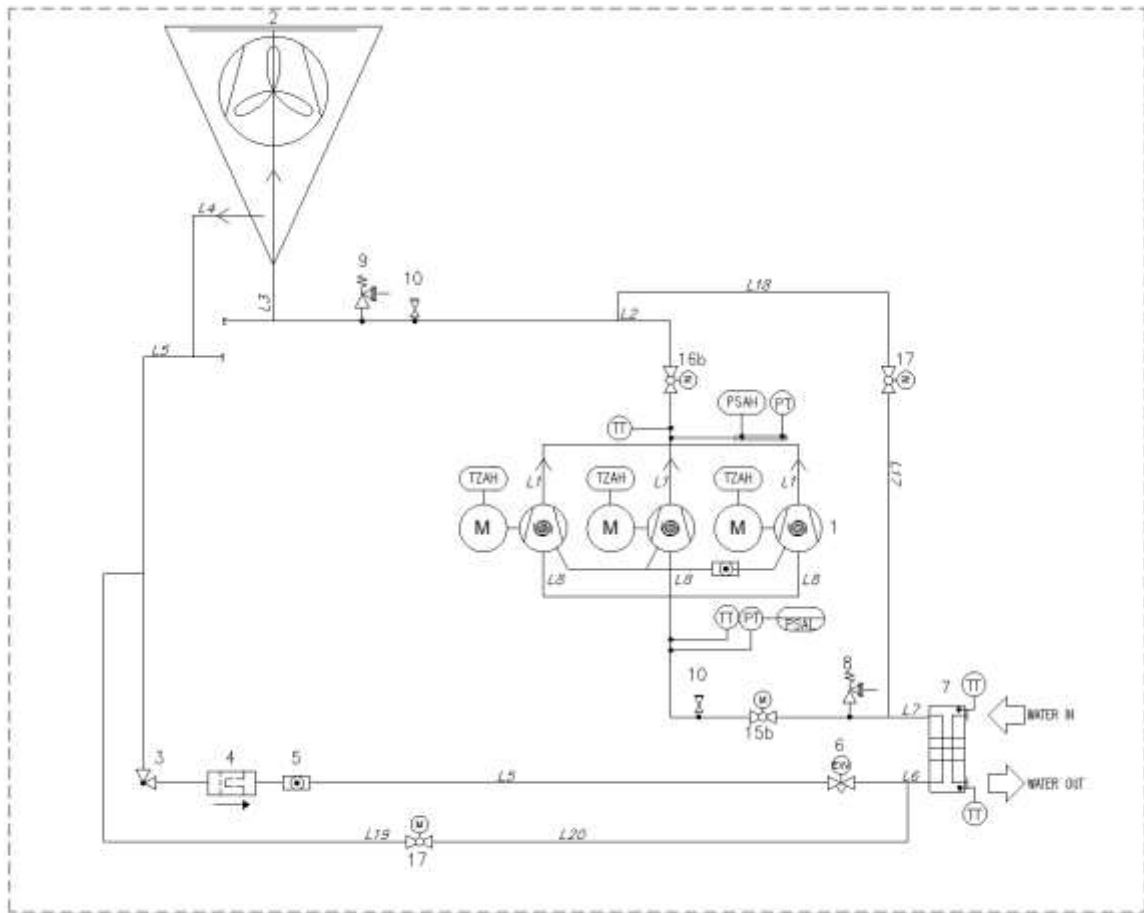

Fig. 14 – Refrigerant circuit diagram (P&ID) with light freecooling option single circuit unit

Water inlet and outlet are indicative. Please refer to the machine dimensional diagrams for exact water connections. The series is composed by mono (one circuit) and dual (two circuits) chiller. Each circuit can be with 3 or 2 compressor (tandem configuration). Only one circuit is reported.

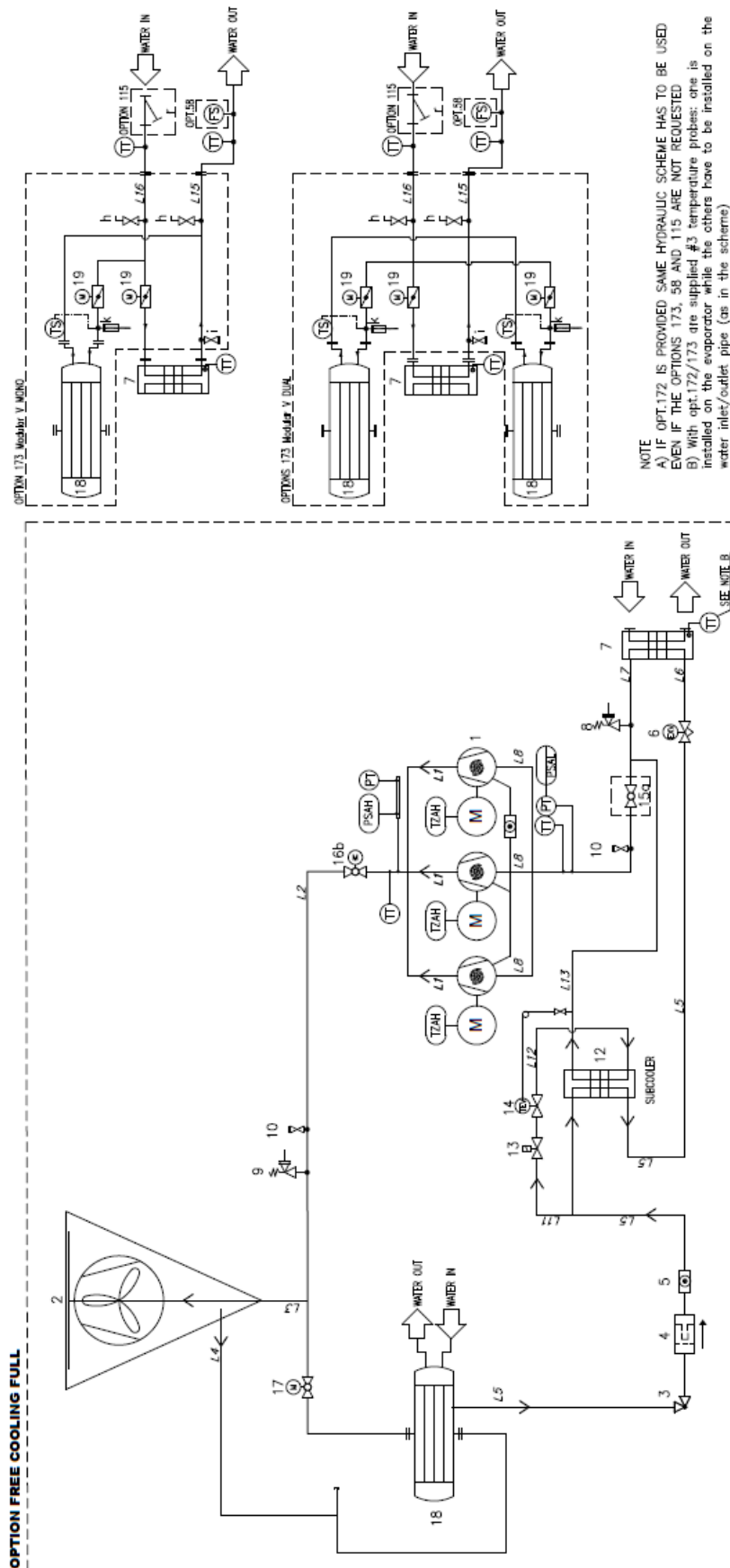

Fig. 15 – Refrigerant circuit diagram (P&ID) with full freecooling option single circuit unit

Water inlet and outlet are indicative. Please refer to the machine dimensional diagrams for exact water connections. The series is composed by mono (one circuit) and dual (two circuits) chiller.

Each circuit can be with 3 or 2 compressor (tandem configuration). Only one circuit is reported.

If opt.172 is provided same hydraulic scheme has to be used even if options 173,58 and 115 are not required.

Legend	
Item	Description
1	Scroll compressors in tandem configuration
2	Microchannel air condenser
3	Angle valve
4	Filter
5	Liquid sight-glass (if not present with 6)
6	Electronic expansion valve
7	BPHE evaporator
8	Low Pressure Safety valve Pt = 24.5 barg
9	High Pressure Safety valve Pt = 45 barg
10	Charge coupling
11	Plate heat exchanger-Heat recovery (optional)
12	Plate heat exchanger-Subcooler (optional)
13	Solenoid valve (optional)
14	Thermostatic expansion valve (optional)
15	Suction valve (optional)
16	Delivery valve (optional)
17	Twin pumps (optional)
18	Tank (optional)
19	Water side safety valve (optional)
20	Shut-off valve (optional)
PT	Pressure transducer
TT	Temperature sensor
PSAH	High pressure switch (42 barg)
PSAL	Low pressure switch (function to check)
TZAH	Electric motor thermistor

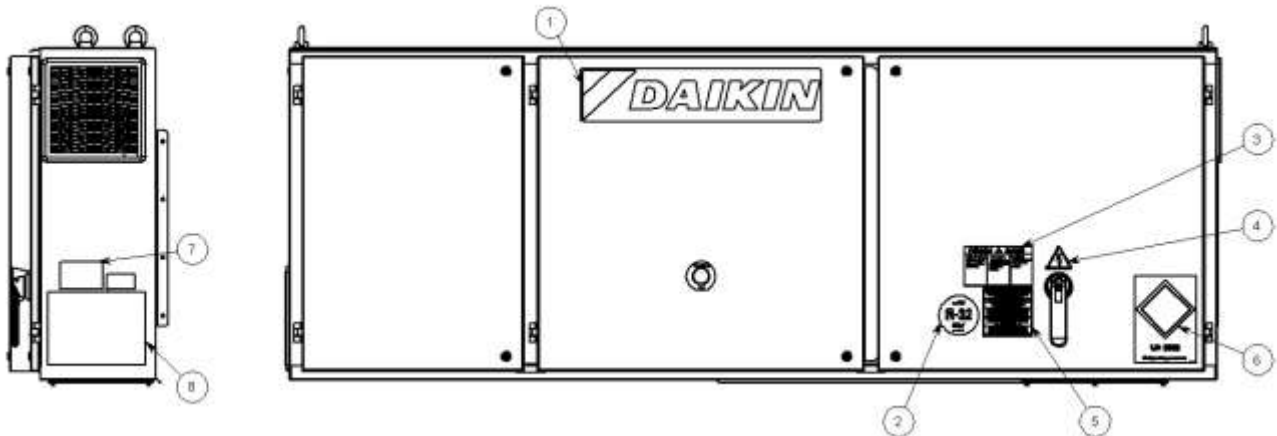

Fig. 16 – Description of labels applied on the electrical panel

Label Identification

1 – Manufacturer logo	5 – Cable tightening warning
2 – Gas type	6 – UN 3358 label
3 – Hazardous Voltage warning	7 – Unit nameplate data
4 – Electrical hazard symbol	8 – Lifting instruction

5 CHECKS FOR THE FIRST START-UP



The unit must be started for the first time ONLY by authorized DAIKIN personnel.

The unit must absolutely not be put into operation, even if for a very short period, without having first meticulously checking the following list in its entirety.

Table 8 – Checks to be performed before starting the unit

General	Yes	No	N/A
Check for external damage	<input type="checkbox"/>	<input type="checkbox"/>	<input type="checkbox"/>
Open all isolation and / or shut-off valves	<input type="checkbox"/>	<input type="checkbox"/>	<input type="checkbox"/>
Verify that the unit is pressurized with refrigerant in all of its parts before making the connection to the hydraulic circuit.	<input type="checkbox"/>	<input type="checkbox"/>	<input type="checkbox"/>
Check the oil level in the compressors	<input type="checkbox"/>	<input type="checkbox"/>	<input type="checkbox"/>
Control wells, thermometers, manometers, controls, etc. installed	<input type="checkbox"/>	<input type="checkbox"/>	<input type="checkbox"/>
Availability of at least 25% of the machine load for testing and control settings	<input type="checkbox"/>	<input type="checkbox"/>	<input type="checkbox"/>
Refrigerated water	Yes	No	N/A
Piping completion	<input type="checkbox"/>	<input type="checkbox"/>	<input type="checkbox"/>
Install the water filter (even when not supplied) at the inlet of the exchangers.	<input type="checkbox"/>	<input type="checkbox"/>	<input type="checkbox"/>
Install a flow switch			
Water circuit filling, air bleeding	<input type="checkbox"/>	<input type="checkbox"/>	<input type="checkbox"/>
Pump installation, (rotation check), filter cleaning	<input type="checkbox"/>	<input type="checkbox"/>	<input type="checkbox"/>
Operation of the controls (three-way valve, bypass valve, damper, etc.)	<input type="checkbox"/>	<input type="checkbox"/>	<input type="checkbox"/>
Water circuit operation and flow balance	<input type="checkbox"/>	<input type="checkbox"/>	<input type="checkbox"/>
Check that all water sensors are correctly fixed in the heat exchange	<input type="checkbox"/>	<input type="checkbox"/>	<input type="checkbox"/>
Electrical circuit	Yes	No	N/A
Power cables connected to the electrical panel	<input type="checkbox"/>	<input type="checkbox"/>	<input type="checkbox"/>
Starter and wired interlocking of the pump	<input type="checkbox"/>	<input type="checkbox"/>	<input type="checkbox"/>
Electrical connection in compliance with local electrical regulations	<input type="checkbox"/>	<input type="checkbox"/>	<input type="checkbox"/>
Install a main switch upstream of the unit, the main fuses and, where required by the national laws of the country of installation, a ground fault detector.	<input type="checkbox"/>	<input type="checkbox"/>	<input type="checkbox"/>
Connect the pump contact(s) in series with the contact of the flow switch(es), so that the unit can operate only when the water pumps are running and the water flow is sufficient.	<input type="checkbox"/>	<input type="checkbox"/>	<input type="checkbox"/>
Provide the main voltage and check that it is within $\pm 10\%$ of the classification given on the nameplate.	<input type="checkbox"/>	<input type="checkbox"/>	<input type="checkbox"/>

Note

This list must be completed and sent to the local Daikin Service office at least two weeks before the start date.

6 IMPORTANT INFORMATION ON THE REFRIGERANT USED

This product contains fluorinated greenhouse gases. Do not vent gases into the atmosphere.

Refrigerant type: R32
GWP Value (global warming potential): 675

6.1 Factory and Field charged units instructions

The refrigerant system is charged with fluorinated greenhouse gases and the refrigerant charge is impressed on the plate, shown below, which is applied inside the electrical panel.

- Fill in with indelible ink the refrigerant charge label supplied with the product as following instructions:
 - the refrigerant charge for each circuit (1; 2; 3) added during commissioning (on-site charging)
 - the total refrigerant charge (1 + 2 + 3)
 - calculate the greenhouse gas emission with the following formula:

$$GWP * total\ charge\ [kg]/1000$$

(use the GWP value mentioned on the greenhouse gases label. This GWP value is based on the 4th IPCC Assessment Report.)

The diagram shows a rectangular label with the following elements:

- Top left: Warning icon and text "Contains fluorinated greenhouse gases" (labeled 'a').
- Top center: Refrigerant type "R32" (labeled 'm') and GWP "675" (labeled 'n').
- Top right: Serial number "CH-XXXXXXXX-KKKKXX" (labeled 'p').
- Main body: A table with 3 rows for circuits 1, 2, and 3. Each row has:
 - Column 1: Circuit number (labeled 'b').
 - Column 2: "1 = [] + [] kg" (labeled 'c' for the first box, 'd' for the second box, and 'e' for the unit).
 - Column 3: "2 = [] + [] kg" (labeled 'e' for the unit).
 - Column 4: "3 = [] + [] kg" (labeled 'e' for the unit).
- Below the table:
 - "[1] + [2] + [3] = [] + [] kg" (labeled 'f' for the unit).
 - "Total refrigerant charge [] kg" (labeled 'g' for the unit).
 - "Factory + Field"
 - "GWP x kg/1000 [] tCO₂eq" (labeled 'h' for the unit).

- a Contains fluorinated greenhouse gases
- b Circuit number
- c Factory charge
- d Field charge
- e Refrigerant charge for each circuit (according to the number of circuits)
- f Total refrigerant charge
- g Total refrigerant charge (Factory + Field)
- h **Greenhouse gas emission** of the total refrigerant charge expressed
- m Refrigerant type
- n GWP = Global Warming Potential
- p Unit serial number



In Europe, the emission of greenhouse gases of the total refrigerant charge in the system (expressed in tonnes of equivalent CO₂) is used to determine the frequency of maintenance interventions. Follow the applicable legislation.

7 PERIODIC CHECKS AND OF PRESSURE EQUIPMENT

The units are included in category III and IV of the classification established by the European Directive 2014/68/EU (PED). For chillers belonging to these categories, some local regulations require a periodic inspection by an authorized person. Please check with your local requirements.

8 DISMISSION AND DISPOSAL

The unit is made of metal, plastic and electronic parts. All of these components must be disposed of in accordance with local disposal laws and if in scope with the national laws implementing the Directive 2012/19/EU (RAEE).

Lead batteries must be collected and sent to specific waste collection centers.

Avoid the escape of refrigerant gases into the environment by using suitable pressure vessels and tools for transferring the fluids under pressure. This operation must be carried out by competent personnel in refrigeration systems and in compliance with the laws in force in the country of installation.



9 DURATION

The useful life of this unit is 10 (ten) years.

After this period the manufacturer advises to carry out a total control of the whole and above all the integrity check of the pressurized refrigeration circuits, as required by the laws in force in some European Community countries.

The present publication is drawn up only for technical support and it does not constitute a binding commitment for Daikin Applied Europe S.p.A.. Its content has been written by Daikin Applied Europe S.p.A. to the best of its knowledge. No explicit or implied warranty is given for the completeness, accuracy, reliability of its contents. All data and specifications contained therein may be subject to change without notice. Refer to the data communicated at the time of the order. Daikin Applied Europe S.p.A. explicitly rejects any liability for any direct or indirect damage, in the broadest sense, arising from or related to the use and/or interpretation of this publication. All content is copyrighted by Daikin Applied Europe S.p.A..

DAIKIN APPLIED EUROPE S.p.A.

Via Piani di Santa Maria, 72 - 00072 Ariccia (Roma) - Italy

Tel: (+39) 06 93 73 11 - Fax: (+39) 06 93 74 014

<http://www.daikinapplied.eu>