

DAIKIN



**Installation and Operation Manual
D-EIOCH00305-17EN**

Intelligent Chiller Manager (iCM)



Original Instructions



Revision History

Version	Date	iCM version	Remarks
1.0	2016/4/21	iCM_AM_Ver1.00	First version
2.0	2017/2/3	iCM_Ver2.00-00.03	Available for Air/Water-Cooled Chillers

Index

Revision History	1
Index3	
1. Introduction	6
2. Functional Overview of iCM.....	7
2.1. System Topology	7
3. Technical Overview.....	9
3.1. Electrical Panel.....	9
3.2. Controllers	10
3.2.1. Main Controller	10
3.2.2. BACnet Module (Optional).....	11
3.2.3. MODbus Module (Optional)	11
3.2.4. I/O Modules	11
3.3. I/O Mapping	11
3.4. Networks.....	11
3.4.1. Modbus® / RS485 (Chiller Network)	11
3.4.2. BACnet.....	11
3.4.3. Daikin On Site	12
3.5. Human Machine Interface (HMI)	12
3.5.1. Built-in HMI.....	12
3.5.2. Remote HMI	12
3.5.3. Web HMI	12
3.6. Temperature sensors.....	13
3.7. Wireless Router	13
3.8. Differential Pressure sensor (Optional)	14
4. Electrical Installation	15
4.1. General specifications.....	15
4.2. Operator's responsibility	15
5. Mechanical Installation	16
5.1. Control Panel installation	16
5.2. Temperature sensor installation	17
5.3. Differential Pressure sensor installation	17
6. Description of Operation.....	19
6.1. Menu Structure	19
6.2. Basic Parts and Operation	21
6.3. LCD Panel Display	22
6.4. Setting Address of Extension I/O Modules	24
6.5. Password Protection	25
7. Scenario of Interaction	26
7.1. Workflow for Initial Configuration / Commissioning.....	26
7.1.1. On Site	26
7.1.2. Off Site	27
7.2. Workflow for Monitoring	28
7.2.1. Status Monitoring.....	28
7.2.2. Alarm Monitoring	28
7.3. Workflow for Operation	29
7.3.1. Commanding	29
7.3.2. Parameter Tuning.....	29
7.4. Workflow for Maintenance.....	30
7.4.1. Equipment Maintenance	30

7.4.2.	HVAC System Component Change	30
8.	Configuration	31
8.1.	Password Input	31
8.2.	Setting System to Config Mode	32
8.3.	System Configuration Setting	34
8.3.1.	Setting Unit	34
8.3.2.	Setting Current Time / Date	36
8.3.3.	Changing Network Setting of Main Controller	36
8.3.4.	Changing Network Setting of BACnet Module	38
8.3.5.	Changing Network Setting of Daikin On Site (DoS: Cloud Connection)	40
8.3.6.	Showing information of iCM	41
8.4.	Equipment Registration	42
8.4.1.	Chiller Registration	44
8.4.2.	PrimaryPump Registration	45
8.4.3.	CondenserPump Registration	45
8.4.4.	CTBypassValve Registration	46
8.4.5.	Sensors Registration	47
8.4.6.	ExtI/O Registration	48
8.4.7.	BACnet_Module Registration	49
8.5.	Equipment Configuration	50
8.5.1.	System Configuration	52
8.5.2.	Chiller Configuration	52
8.5.3.	Evaporator Shut Off Valve Configuration	54
8.5.4.	Condenser Shut Off Valve Configuration	54
8.5.5.	Primary Pump Configuration	55
8.5.6.	Condenser Pump Configuration	56
8.5.7.	Sensor Configuration	57
8.5.8.	Modbus Communication Setting	61
8.5.9.	Ai Threshold Setting	63
9.	Equipment Control Setting	64
9.1.	Chiller Control Setting	66
9.1.1.	Setting sequence order when using fixed order sequencing	68
9.1.2.	Setting detailed options for staging up / down	68
9.2.	Primary Pump Control Setting	71
9.2.1.	Setting PI Parameters for Pump VFD Control	72
9.2.2.	Setting periodical pump staging for rotation	73
9.2.3.	Setting minimum / maximum number of operating pumps for each piping group	73
9.3.	Bypass Valve Control Setting	74
9.3.1.	Setting PI Parameters for Bypass Valve Control	75
9.4.	Condenser Pump Control Setting	75
9.4.1.	Setting DT_PI Parameters for Pump VFD Control	77
9.4.2.	Setting DP_PI Parameters for Pump VFD Control	77
9.4.3.	Setting minimum / maximum number of operating pumps for each piping group	78
9.5.	Cooling Tower Bypass Valve Control Setting	79
9.5.1.	Setting PI Parameters for Cooling Tower Bypass Valve Control	80
9.6.	System Control Setting	81
9.6.1.	Power Failure Recovery	82
9.6.2.	Protect System	83
9.6.3.	Double Temperature Setpoint	84

9.6.4.	Pull Down Rate Control	85
9.6.5.	Setpoint reset	86
9.7.	Source of Input Setting	88
10.	Trial Run	91
10.1.	Chiller Trial Run	93
10.2.	I/O Trial Run	93
10.3.	BACnet Module Trial Run	100
11.	Saving / Loading Configuration Data	101
12.	Monitoring	103
12.1.	Showing Current Status of System	103
12.2.	Showing Current Status of Chillers	104
12.2.1.	Showing the overview of chillers	104
12.2.2.	Showing the detailed view of chillers	105
12.3.	Showing Current Status of Evaporator Side Shut Off Valve	106
12.3.1.	Showing the detailed view of Evaporator Side Shut Off Valve	106
12.4.	Showing Current Status of Condenser Side Shut Off Valve	107
12.4.1.	Showing the detailed view of Condenser Side Shut Off Valve	107
12.5.	Showing Current Status of Primary Pumps	108
12.5.1.	Showing the detailed view of Primary Pumps	108
12.6.	Showing Current Status of Bypass Valve	109
12.7.	Showing Current Status of Condenser Pumps	109
12.7.1.	Showing the detailed view of Condenser Pumps	109
12.8.	Showing Current Status of Cooling Tower Bypass Valve	110
12.9.	Showing Current Status of Sensors	110
12.10.	Showing Current Status of I/O	111
12.11.	Showing Current Status of Controls	111
12.11.1.	Show current status of chiller control	112
12.11.2.	Show current status of primary pump control	112
13.	Operation	113
13.1.	Basic Commanding	113
13.2.	Resetting emergency stop	114
13.3.	Setting Chillers to "Maintenance"	115
14.	Alarming	117
14.1.	Showing Current List of Alarms	117
14.2.	Showing History of Alarms	118
14.3.	Deleting History of Alarms	119
14.4.	Resetting Alarms	120
15.	APPENDIX – Alarms	123
15.1.	Alarm Codes	123
15.1.1.	Alarm for the chiller system	123
15.1.2.	Alarms for individual equipment	126
16.	APPENDIX – BACnet Integration Data (Main Controller)	127
17.	APPENDIX – HMI Monitoring and Command	128
18.	APPENDIX – I/O Mapping	130
19.	APPENDIX – Compatibility List	139
20.	APPENDIX – Integrated Modbus Points	140
20.1.	Global chillers	140
20.2.	U.S. Chillers	141

1. Introduction

READ THIS MANUAL CAREFULLY BEFORE INSTALLING AND STARTING UP THE UNIT. IMPROPER INSTALLATION COULD RESULT IN ELECTRIC SHOCK, SHORT-CIRCUIT, LEAKS, FIRE OR OTHER DAMAGE TO THE EQUIPMENT OR INJURE TO PEOPLE. THE UNIT MUST BE INSTALLED BY A PROFESSIONAL OPERATOR/TECHNICIAN UNIT STARTUP HAS TO BE PERFORMED BY AUTHORIZED AND TRAINED PROFESSIONAL ALL ACTIVITIES HAVE TO BE PERFORMED ACCORDING TO LOCAL LAWS AND REGULATION.

UNIT INSTALLATION AND START UP IS ABOSOLUTELY FORBIDDEN IF ALL INSTRUCTION CONTAINED IN THIS MANUAL ARE NOT CLEAR.

IF CASE OF DOUBT CONTACT THE MANUFACTURER REPRESENTATIVE FOR ADVICE AND INFORMATION.

2. Functional Overview of iCM

2.1. System Topology

The system topology for the package of iCM is described below.

Table 1 - Equipment overview

	Availability	Drive		Piping		Cooling type	
		CSD	VFD	Manifolded	Dedicated	Air-cooled	Water-cooled
Chiller	Yes	Yes	Yes	-	-	Yes	Yes
Evaporator pumps	Yes	Yes	Yes	Yes	Yes	-	-
Shut-off valves (evaporator side)	Yes	-	-	-	-	-	-
Bypass valve (evaporator side)	Yes	-	-	-	-	-	-
Condenser pumps	Yes	Yes	Yes	Yes	Yes	-	-
Shut-off valves (condenser side)	Coming Soon	-	-	-	-	-	-
Bypass valve (condenser side)	Coming Soon	-	-	-	-	-	-

CSD: Constant Speed Driver

VFD: Variable Frequency Driver

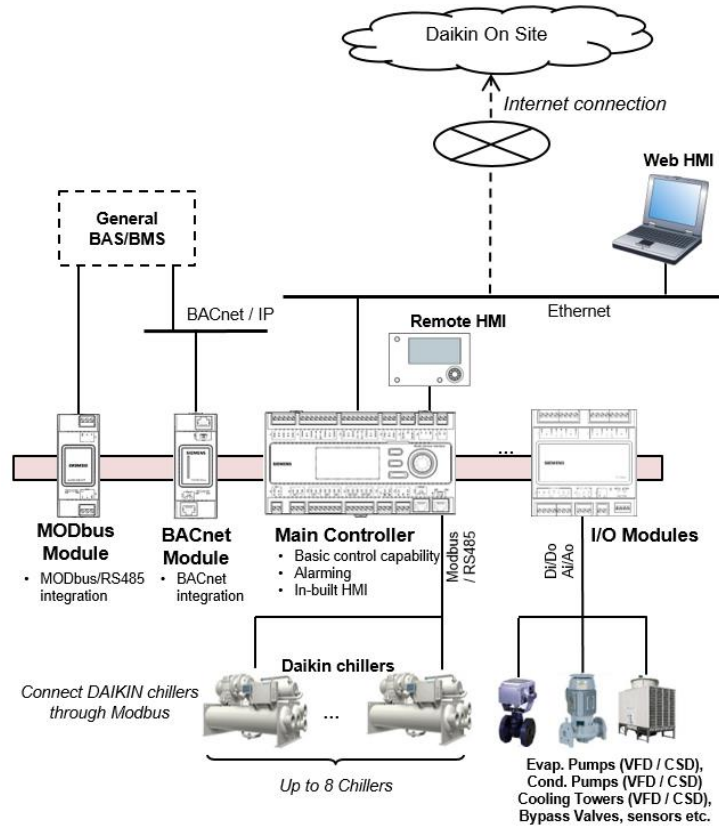

Figure 1 - System Topology of iCM

- ❑ BACnet / IP connectivity is offered through BACnet Module for integration with general BAS/BMS
- ❑ Built-in HMI, Remote HMI and Web HMI (on Daikin on Site; DoS) is available for monitoring and configuration
- ❑ From main controller, connectivity to “Daikin on Site” (DoS: Cloud platform), remote monitoring and service

3. Technical Overview

iCM (intelligent Chiller manager) consists of:

- Electrical Panel
- Temperature sensors
- 3G router for internet connectivity
- Optional devices:
 - Communication modules for BMS integration
 - By-pass valve on primary loop

3.1. Electrical Panel

Table 2 Electrical panel technical data

		EKDICMPAB	EKDICMPAL	EKDICMPAF	
Environmental conditions	Operating temperature air	-20...60°C			
	Storage temperature	-40...70°C			
	Humidity	<90%Rh (without condensation)			
	Air pressure	min. 700KPa, corresponding to max. 3000m above sea level			
Dimension	Panel	Metal			
	External door	N/A	Lexan		
	Internal door	Metal with lamps	Metal with HMI and lamps and three position selector		
	Size (L x H x W)	500x700x250	600x800x300	800x1000x300	
	Weight	30Kg	40Kg	50Kg	
	IP Code (International protection)		IP54 (external)	IP66 (external)	IP66 (external)
			IP20 (internal)	IP20 (internal)	IP20 (internal)
IK Code (mechanical protection)	IK08				
Power Supply	Phase	1 phase			
	Frequency	50...60 Hz			
	Input Voltage	230 VAC +/- 10%			
	Output Voltage	24VAC			
	Nominal Current	40A			
	Peak Current	10kA			
Power Consumption	Controller + Modules	Max: 161 VA Typical: 150 VA			
Communications	MODbus RTU for chiller network	RS-485:			

3.2. Controllers

With the Microtech III family of controllers, Daikin offers maximum flexibility in the control and monitoring of chiller plant systems. Comprehensive system functions such as alarm management, time scheduling and trend data storage cover all requirements associated with the operation of a chiller plant room system.

- ❑ Main controller
- ❑ Daikin on Site (DoS) through IP Service Port and internet connectivity
- ❑ Daikin Chiller Management through in-built MODbus RTU/RS485
- ❑ Integration by BMS (Building Management Station)
 - BACnet communication module
 - MODbus communication module
- ❑ I/O modules

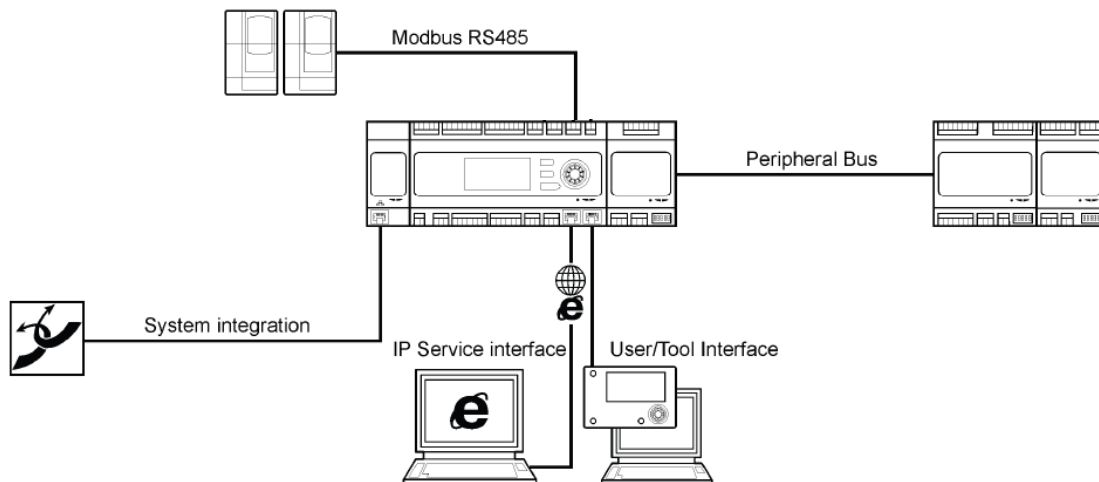

Figure 2 Controller architecture

3.2.1. Main Controller

The main controller provide the following functions

- ❑ Control functions
- ❑ Built-in HMI for monitoring and setting
- ❑ Onboard Modbus / 485 for connection with Chiller Modbus network as Master device.
- ❑ Onboard IP Service Interface port for connection with Ethernet network
- ❑ Onboard I/O's
- ❑ Provision for adding extension I/O's
- ❑ Provision for adding communication modules



3.2.2. BACnet Module (Optional)

The BACnet module provides BACnet / IP integration when connected to the controller.



3.2.3. MODbus Module (Optional)

The MODbus module provides Modbus RTU/ RS-485 integration as Slave device when connected to the main controller.



3.2.4. I/O Modules

The I/O modules provide additional I/O points by connecting to the main controller sensors, valve actuators, pumps and cooling towers are connected through the I/O module. The types of I/O points include the following.

- Analog Outputs: 4-20mA
- Analog Inputs: NTC 10K
- Digital Outputs: Potential free contacts (Non-Voltage)
- Digital Inputs are: Potential free / Potential contacts (Voltage)



The number of I/O modules needed varies depending on the system configuration..

3.3. I/O Mapping

The mapping of I/O's on the main controller and the extension I/O modules is predefined. You can find the full list of I/O mapping in the appendix to this document (18 APPENDIX – I/O Mapping)

3.4. Networks

There are three communication Networks in the iCM:

- Modbus® / RS485 for the integration of chiller data into the iCM controller
- BACnet / IP or Modbus®RTU / RS485 for the connection between the iCM controller and a general BAS/BMS
- IP Service interface over Ethernet for communication with Daikin on Site through Internet connection.

3.4.1. Modbus® / RS485 (Chiller Network)

The data residing in the chillers are integrated into the iCM controller using Modbus® / RS485. The set of Modbus® data point varies slightly with the chiller type. iCM has Modbus data map for Daikin global standard chillers pre-included, allowing for easy Modbus / RS485 connection through just simple configuration. (19 APPENDIX – Compatibility List)

In the appendix of this document you will find an overview of which Modbus® points that are integrated into the iCM (20 APPENDIX – Integrated Modbus Points)

3.4.2. BACnet

For general integration of the iCM and a BAS/BMS workstation, BACnet is available.

You can find the full list of BACnet points for iCM in the appendix to this document (16 APPENDIX – BACnet Integration Data (Main Controller)) Modbus®

For general integration of the iCM and a BAS/BMS workstation, MODbus RTU can be provided under request.

3.4.3. Daikin On Site

Providing an internet connectivity to the controller through onboard IP service interface, it is possible to take advantage of the Daikin On Site service.

Daikin On Site makes use of the benefits offered by the cloud technology that allows remote access and servicing at any time from any location. All data from the system plant-room are constantly collected and automatically stored in the cloud server. Customer can access and

- monitor in real time the system through a graphical interface
- manage the stored data to create trend
- download the data from the server.

Daikin On site permits system diagnostic in real time, simple maintenance, energy efficiency evaluation and optimization.

3.5. Human Machine Interface (HMI)

Depended on the sold solution the system comes with one or more of the following HMI's:

- Built-in HMI on the controller
- Remote HMI
- WEB HMI

You can find the list of points that can be monitored and commanded from the HMI in the appendix (17 APPENDIX – HMI Monitoring and Command)

NOTE: Remote HMI is not provided with EKDICMPAB

3.5.1. Built-in HMI

Built-in HMI is the HMI directly on the iCM main controller. Built-in HMI is capable of full operation of the iCM.

It has an LCD display for text and icons. The push dial and buttons allows for easy operation.



3.5.2. Remote HMI

The Remote HMI is capable of full operation and configuration of the iCM.

The remote HMI has a high-resolution illuminated LCD display for text and graphics, push dial and buttons for operation, and a common alarm indicator.

The Remote HMI can be mounted e.g. in the operators office or at the iCM panel door.



3.5.3. Web HMI

With its integrated Internet technology, the embedded Web server allows full plant operation of the iCM using standard Web browsers.

3.6. Temperature sensors

Two immersion temperatures sensors are included in the kit to measure the entering and leaving water temperature of the system.

Table 3 Temperature sensors technical data

Technical data	Type	Immersion temperature sensor
	Sensing element	NTC10K
	Immersion length	100mm
Functional data	Measuring rate	-30...125°C
	Time constant	30s
	Accuracy	Refer to sensor datasheet
	Nominal pressure	PN16
Degree of protection	Protection class	III according to EN 60730-1
Electrical connections	Screw terminals	1 x 2,5 mm ² or 1,5 mm ²
	Connections	Interchangeable
Environmental conditions	Operation	Class 3K5
	Temperature	-25...70°C
	Humidity	5...95% r.h.

3.7. Wireless Router

Providing internet connectivity to the controller, it is possible to start the Daikin on Site service for remote monitoring and data storing.

The 3G router is part of the iCM standard package.

Table 4 Wireless Router technical data

Technical data	Wireless 3G Modem	VODAFONE MachineLink_3G
	RF Antenna	PANORAMA ANTENNAS MAR-7-21-2SP
Connections	RJ45 Ethernet	10/100 base T
Power supply	MEAN WELL	10W AC/DC
	Input Voltage	115/230VAC
	Output Voltage	12VDC
Environmental conditions	Ambient temperature	-30...70°C
	Ambient humidity	90% r.h. @ 60°C

3.8. Differential Pressure sensor (Optional)

In case of primary loop variable flow and consequently control of variable frequency driver on the primary pumps, a differential pressure sensor must be installed in the chiller plant-room to allow iCM perform the correct control logic.

Table 5 Differential Pressure Sensor Technical data

Technical data	Type	Differential pressure sensor For neutral or mildly corrosive liquids
	Measuring element	Ceramic
Functional data	Measuring range	0...1.6 bar 0...2.5 bar 0...4 bar According to requested range
	Accuracy	0.1% Full scale
	Response time	<5ms
	Admissible temperature of medium	-15...80°C
	Operating voltage	DC 11...33V
	Output signal	DC 4...20mA
Degree of protection	Protection class	IP65
Connection	Electrical cable	Plug with seals and PG9 cable glands included
	Pressure connections	Male-threaded G1/8" with screwed fitting for copper pipes, 6mm diameter
Environmental condition	Ambient temperature	-15...85°C
	Ambient humidity	<95% r.h. (non-condensing)

4. Electrical Installation

4.1. General specifications

All electrical connections to the unit must be carried out in compliance with laws and regulations in force.

All installation, management and maintenance activities must be carried out by qualified personnel.

Refer to the specific wiring diagram for the unit you have bought. Should the wiring diagram not be on the control panel or should it have been lost, please contact your manufacturer representative, who will send you a copy.

In case of discrepancy between wiring diagram and electrical panel/cables, please contact the manufacturer representative.

Only use copper conductors. Failure to use copper conductors could result in overheating or corrosion at connection points and could damage the control panel.

To avoid interference, all control wires must be connected separately from the power cables. Use different electrical passage ducts for this purpose.

Particular care must be taken when realizing wire connections to the switchbox; if not properly sealed, cable entries may allow ingress of water into the switchbox which may cause damage to the equipment inside.

Before any installation and connection works, the unit must be switched off and secured.

This product complies with EMC standards for industrial environments. Therefore it is not intended for use in residential areas, e.g. installations where the product is connected to a low voltage public distribution system. Should this product need to be connected to a low voltage public distribution system, specific additional measures will have to be taken to avoid interference with other sensitive equipment.

4.2. Operator's responsibility

It is essential that the operator is appropriately trained and becomes familiar with the system before operating the panel. In addition to reading this manual, the operator must study the databook for functional overview and the wiring diagram in order to understand start-up sequence, operation, management of the peripherals connected to the control panel.

5. Mechanical Installation

5.1. Control Panel installation

Control panel can be installed free standing taking care of the following minimum clearance requirements:

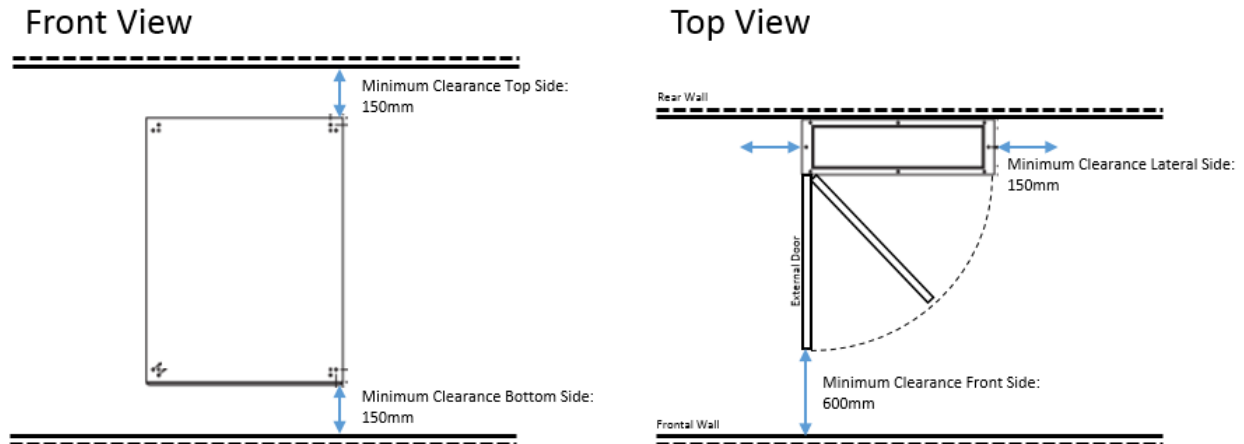

Figure 3 Minimum Clearance Requirements

Cable entry hole is on the bottom side of the panel

NOTE: dimension of the external door are shown in Table 2 Electrical panel technical data

For the hanging installation on a wall, please use the brackets shown in the following picture, provided with panel:



Figure 4 Brackets position

NOTE: Weight of different sizes of the panel are shown in Table 2 Electrical panel technical data

5.2. Temperature sensor installation

The sensors should be located on the supply header and on return header.

The location should be chosen such that the water must be well mixed where the temperature is acquired.

The sensor should be mounted such that the cables does not enter from the top (only by side).

The immersion length must be at least 60mm.

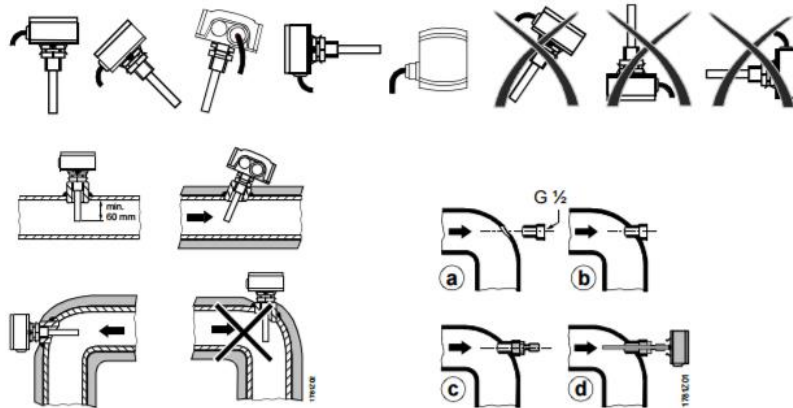

Figure 5 Temperature sensor mounting

For more information, please refer to datasheet and installation guide provided with sensor.

5.3. Differential Pressure sensor installation

Differential pressure sensors must be mounted between the inlet and outlet water pipes of the furthest load in the system.

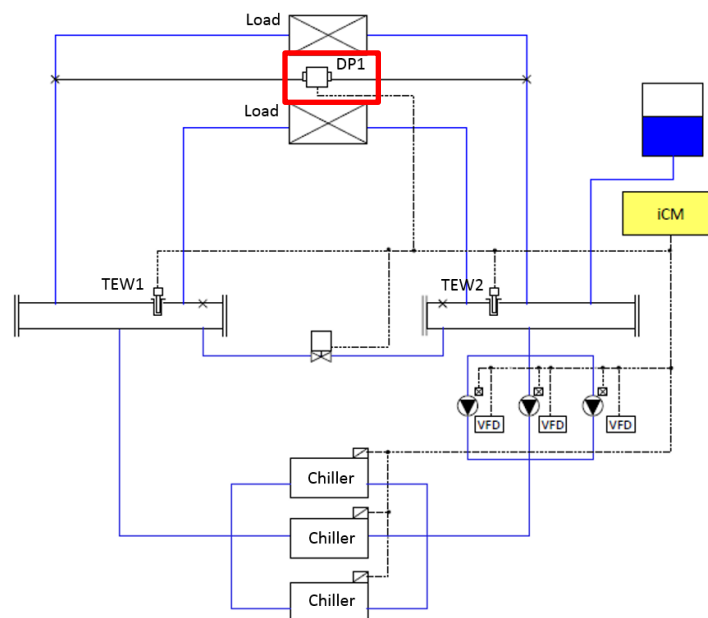

Figure 6 Differential pressure sensor position

The sensor must be always mounted lower than the pressure measuring points.

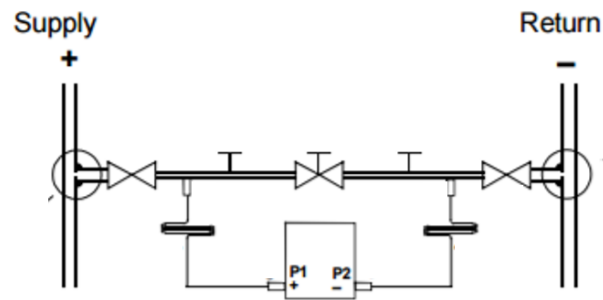

Figure 7 DP Sensor mounting

For detailed information, please refer to the datasheet and installation guide provided with sensor.

6. Description of Operation

6.1. Menu Structure

The menu structure of iCM is described below.

<ul style="list-style-type: none"> □ Status <ul style="list-style-type: none"> ○ Command <ul style="list-style-type: none"> ▪ Emergency Stop Reset ○ Chiller Status <ul style="list-style-type: none"> ▪ Chiller#01 Detail ... ▪ Chiller#08 Detail ○ EvShutOffValve Status <ul style="list-style-type: none"> ▪ EvSO_Valve01 Detail ... ▪ EvSO_Valve08 Detail ○ CndShutOffValve Status <ul style="list-style-type: none"> ▪ CndSO_Valve01 Detail ... ▪ CndSO_Valve08 Detail ○ Primary Pump Status <ul style="list-style-type: none"> ▪ Primary Pump#01 Detail ... ▪ Primary Pump#08 Detail ○ Bypass Valve Status ○ CondenserPump Status <ul style="list-style-type: none"> ▪ CondenserPump01 Detail ... ▪ CondenserPump08 Detail ○ CTBypassValve Status ○ Sensors Status ○ I/O Status ○ Control Status <ul style="list-style-type: none"> ▪ ChillerCtrl Status ▪ PriPpCtrl Status 	<ul style="list-style-type: none"> □ Setting <ul style="list-style-type: none"> ○ System Control Parameters <ul style="list-style-type: none"> ▪ Double Temperature Setpoint ▪ Pull Down Rate Control ▪ Power Failure Recovery ▪ SetptReset ▪ Protect System ○ Device Control Parameters <ul style="list-style-type: none"> ▪ Chiller Control ▪ Primary Pump Control ▪ Bypass Valve Control ▪ CondenserPump Control ▪ CTBypassValve Control ○ Control Mode Setting ○ System Setting <ul style="list-style-type: none"> ▪ Date/Clock ▪ Network <ul style="list-style-type: none"> • Main NetworkSetting • BACnet NetworkSetting • Daikin On Site Status • HMI for Web Setting • About
---	---

- Config Mode
 - Device Config
 - System Config
 - Chiller Config
 - Primary Pump Config
 - Sensors Config
 - Modbus Comm. Setting
 - Trial Run
 - Chiller Trial Run
 - I/O Trial Run (#1 to #17)
 - Device Registration
 - Chiller Registration
 - Primary Pump Registration
 - CondenserPump Registration
 - CTBypassValve Registration
 - Sensors Registration
 - Ext/I/O Registration
 - Backup/Restore
 - Data Management

*Special menus

- Password
 - Enter Password
- Alarm entry
 - Alarm List overview
 - Alarm History overview

6.2. Basic Parts and Operation

Basic parts and operation of iCM controller are described below.

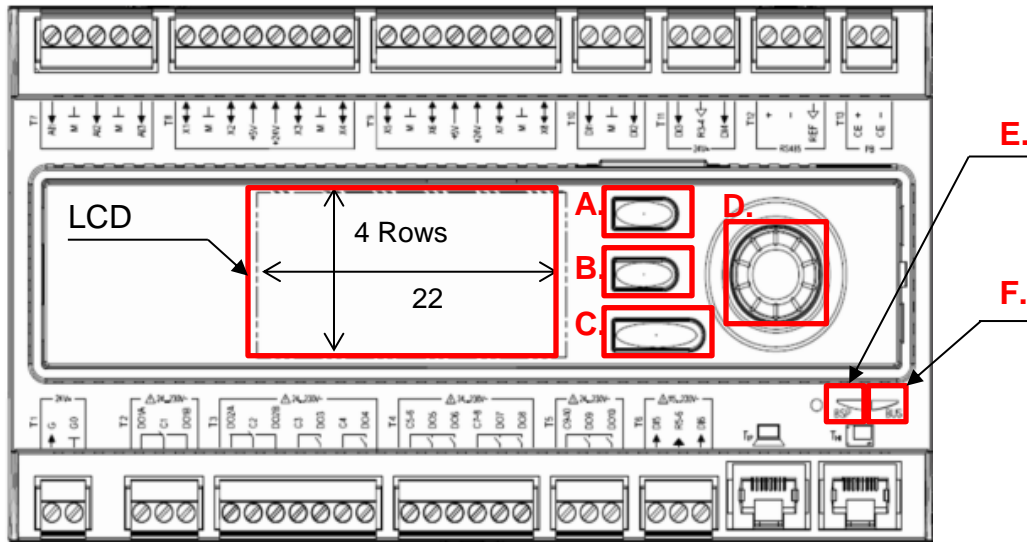





Figure 8 - Controller description

- A)  Alarm Button: Used to jump to “Alarming” Screen
- B)  Home Button: Used to jump to “MainMenu” Screen
- C)  Back Button: Used to go back one screen or Discard input value
- D)  Click-dial: Turn: Select Next/Previous row or Change input value
Push: Jump to linked page or Validate input value

*When using the click-dial, turning the dial faster enables bigger digit of input value to change.

- E) BSP Indicator LED:
This LED indicates the status of the controller

Mode	LED status
SW update mode (download active on a new BSP, application)	Every second alternating between red and yellow
Application running	Green on
Application loaded but not running	Yellow on
Application not loaded	Yellow flashing (50 ms on, 1000 ms off)
BSP error (software error)	Red blinking at 2 Hz
Hardware error	Red on





- F) Bus Indicator LED:
This LED only indicates the status of the integrated modem communication.

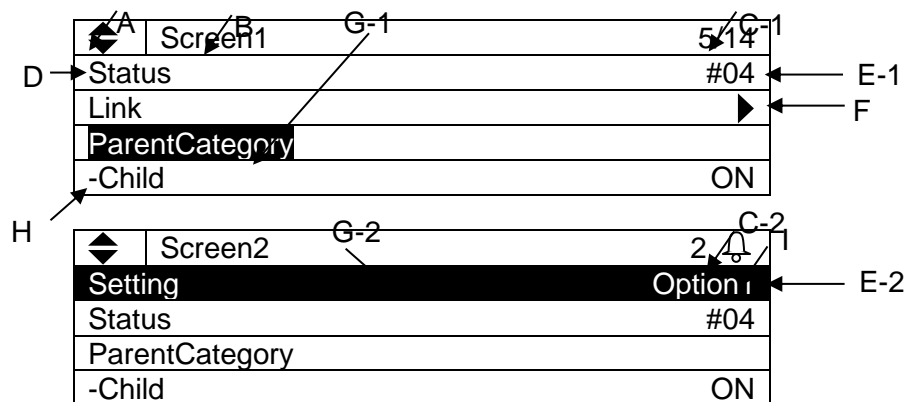

Mode	LED status
No modem connected, or LED disabled	Off
Modem connected and initialized no communication active	Yellow on
Modem connected and communication active	Green on
Modem connected but errors active (like provider missing, no initialization possible)	Red on
BSP error (software error)	Red blinking at 2Hz
Hardware error	Red on

6.3. LCD Panel Display

Below, basic composition of LCD panel display is explained.



- A. Hidden row indicator
 ▼ : Hidden rows exist below
 ◆ : Hidden rows exist below and above
 ▲ : Hidden rows exist above
- B. Screen title
 Title of the currently displayed screen
- C. Row number
 C-1) Current row / Available rows on each screen is displayed
 C-2) Only current row is shown when alarm sign  is displayed
- D. Item name
 Item name is displayed on the left side
- E. Value
 Current status or setting is displayed on the right side.
 E-1) Unchangeable values display the status
 E-2) Changeable values can be modified by selecting the row then clicking on the click-dial .
- F. Link
 ► : Link to another page available. You can jump to the linked page by clicking on the click-dial .
- G. Current row
 Currently selected row is shown with inverted cursor. The cursor can be moved by turning the click-dial .
- G-1) Only item name or “-” character is inverted for rows with unchangeable value

- G-2) Whole row is inverted for rows with changeable value
- H. Hierarchy
 - Item name with “-” indicate that it is a child of the above item.
- I. Alarm
 - Alarm sign  is shown when there is an active alarm. You can check the details of the alarm by pushing the alarm button .

6.4. Setting Address of Extension I/O Modules

For each extension I/O module, predefined address needs to be set via DIP switches on the modules as shown below.

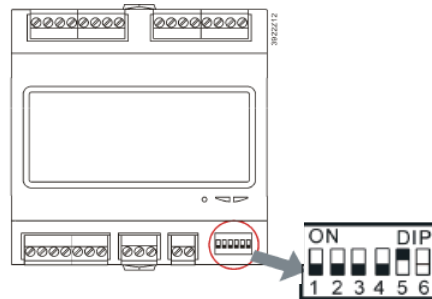
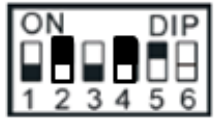

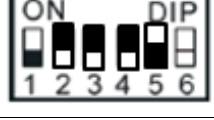
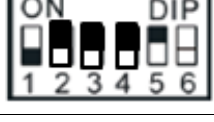



Figure 9 - DIP Switches

Table 6 DIP Switch Setting

Name	Addr.	DIP switch setting					Image
		Switch1	Switch2	Switch3	Switch4	Switch5	
Ext. Module1 P.P.1 PrimPmp 1-2	1	OFF	OFF	OFF	OFF	ON	
Ext. Module2 P.P.2 PrimPmp 3-4	2	OFF	OFF	OFF	ON	OFF	
Ext. Module3 P.P.3 PrimPmp 5-6	3	OFF	OFF	OFF	ON	ON	
Ext. Module4 P.P.4 PrimPmp 7-8	4	OFF	OFF	ON	OFF	OFF	
Ext. Module5 S.V.1 ShutOffVlv 1-4	5	OFF	OFF	ON	OFF	ON	
Ext. Module6 S.V.2 ShutOffVlv 5-8	6	OFF	OFF	ON	ON	OFF	
Ext. Module9 CW.Sns.1 CoolingSns 1-2	9	OFF	ON	OFF	OFF	ON	
Ext. Module10 CW.Sns.2 CoolingSns 3-4	10	OFF	ON	OFF	ON	OFF	

Ext. Module11 CW.P.1 CoolingPmp 1-2	11	OFF	ON	OFF	ON	ON	
Ext. Module12 CW.P.2 CoolingPmp 3-4	12	OFF	ON	ON	OFF	OFF	
Ext. Module13 CW.P.3 CoolingPmp 5-6	13	OFF	ON	ON	OFF	ON	
Ext. Module14 C.W.P.4 CoolingPmp 7-8	14	OFF	ON	ON	ON	OFF	
Ext. Module15 CW.S.V.1 ShutOffVlv 1-4	15	OFF	ON	ON	ON	ON	
Ext. Module16 CW.S.V.2 ShutOffVlv 5-8	16	ON	OFF	OFF	OFF	OFF	

6.5. Password Protection

iCM has password protection functionality to avoid unauthorized changes in the setting.

7. Scenario of Interaction

Table 7 illustrates overview of workflow for working with iCM. Detail of each scenario is described in the following pages.

Table 7 Scenario of Interaction

A. Initial configuration / Commissioning	7.1.1 On Site
	7.1.2 Off Site
B. Monitoring	7.2.1 Status Monitoring
	7.2.2 Alarm Monitoring
C. Operation	7.3.1 Commanding
	7.3.2 Parameter Tuning
D. Maintenance	7.4.1 Equipment Maintenance
	7.4.2 HVAC System Component Change

7.1. Workflow for Initial Configuration / Commissioning

7.1.1. On Site

Table 8 illustrates steps for initial configuration of iCM on site.

Table 8 Workflow for Initial Configuration / Commissioning On Site

Step	Name	Description	Reference chapter
1	Password input	Input password to show service menu	8.1 Password Input
2	Set system to Config Mode	Set system to Config Mode to enable equipment registration etc	8.2 Setting System to Config Mode
3	System Configuration	Setting of IP address, date and time etc	8.3 System Configuration Setting
4	Equipment registration	Registration of equipment for control from iCM	8.4 Equipment Registration
5	Equipment Initial setting	Initial setting for each equipment	8.5 Equipment Configuration
6	Equipment control setting	Setting of parameters for equipment control (e.g. chiller staging, pump VFD control etc)	9 Equipment Control Setting
7	System control setting	Setting of parameters for system control (e.g. double setpoint, pull down rate control etc)	9.6 System Control Setting
8	Source of input setting	Setting of source of input for each command	9.7 Source of Input Setting
9	Trial run	Send command to each equipment to check connection	10 Trial Run
10	Backup configuration	Backup configuration data to SD card	11 Saving / Loading Configuration Data
11	Unset Config Mode	Unset system from config mode to enable system operation	8.2 Setting System to Config Mode

7.1.2. Off Site

Table 9 illustrates steps for initial configuration of iCM off site.

Table 9 Workflow for Initial Configuration / Commissioning Off Site

Step	Name	Description	Reference chapter	
With Off-site iCM	1	Password input	Input password to show service menu	8.1 Password Input
	2	Set system to Config Mode	Set system to Config Mode to enable equipment registration etc	8.2 Setting System to Config Mode
	3	System setting	Setting of IP address, date and time etc	8.3 System Configuration Setting
	4	Equipment registration	Registration of equipment for control from iCM	8.4 Equipment Registration
	5	Equipment Initial setting	Initial setting for each equipment	8.5 Equipment Configuration
	6	Equipment control setting	Setting of parameters for equipment control (e.g. chiller staging, pump VFD control etc)	9 Equipment Control Setting
	7	System control setting	Setting of parameters for system control (e.g. double setpoint, pull down rate control etc)	9.6 System Control Setting
	8	Source of input setting	Setting of source of input for each command	9.7 Source of Input Setting
	9	Save configuration	Save off-site configuration data to SD card	11 Saving / Loading Configuration Data
With On-site iCM	10	Set system to Config Mode	Set system to Config Mode to enable trial run menu	8.2 Setting System to Config Mode
	11	Load configuration	Load configuration to on-site iCM	11 Saving / Loading Configuration Data
	12	System Configuration	Setting of IP address, date and time which could not be done off-site	8.3 System Configuration Setting
	13	Trial run	Send command to each equipment to check connection	10 Trial Run
	14	Backup configuration	Backup configuration data to SD card	11 Saving / Loading Configuration Data
	15	Unset Config Mode	Unset system from config mode to enable system operation	8.2 Setting System to Config Mode

7.2. Workflow for Monitoring

7.2.1. Status Monitoring

Table 10 illustrates steps for status monitoring on iCM

Table 10 Workflow for Status Monitoring

Step	Name	Description	Reference chapter
1	Monitor Status	Monitor status of system and each equipment to find potential problems	12.1 Showing Current Status of System 12.2 Showing Current Status of Chillers 12.3 Showing Current Status of Evaporator Side Shut Off Valve 12.4 Showing Current Status of Condenser Side Shut Off Valve 12.5 Showing Current Status of Primary Pumps 12.6 Showing Current Status of Bypass Valve 12.7 Showing Current Status of Condenser Pumps 12.8 Showing Current Status of Cooling Tower Bypass Valve 12.9 Showing Current Status of Sensors 12.10 Showing Current Status of I/O

7.2.2. Alarm Monitoring

Table 11 illustrates steps for alarm monitoring on iCM

Table 11 Workflow for Alarm Monitoring

Step	Name	Description	Reference chapter
1	Check Alarm	Check to see which alarm is active	14 Alarming
2	Make Corrective Actions	Make necessary changes, actions	- Not done from iCM
3	Monitor Status	Monitor status of system and each equipment to ensure the system is operating correctly	12 Monitoring
4	Alarm Reset	Reset Alarm from iCM as needed	14.4 Resetting Alarms

7.3. Workflow for Operation

7.3.1. Commanding

Table 12 illustrates steps for alarm monitoring from iCM

Table 12 Workflow for commanding from iCM

Step	Name	Description	Reference chapter
1	Source of input setting	Set source of input for desired command to manual	9.7 Source of Input Setting
2	Command	Send various commands from HMI	13 Operation

7.3.2. Parameter Tuning

Table 13 illustrates steps for tuning of control parameters from iCM

Table 13 Workflow for Parameter Tuning

Step	Name	Description	Reference chapter
1	Monitor Status	Monitor status of system and each equipment to find potential problems	12 Monitoring
2	Password input	Input password to show service menu	8.1 Password Input
3	Equipment control setting	Setting of parameters for equipment control (e.g. chiller staging, pump VFD control etc)	9 Equipment Control Setting
4	System control setting	Setting of parameters for system control (e.g. double setpoint, pull down rate control etc)	8.3 System Control Setting
5	Monitor Status	Monitor status of system and each equipment to find potential problems	12 Monitoring

7.4. Workflow for Maintenance

7.4.1. Equipment Maintenance

Table 14 illustrates steps for maintenance of equipment.

Table 14 Workflow for Maintenance of Equipment

Step	Name	Description	Reference chapter
1	Set equipment as Not Available	Set equipment as "Not Available" from iCM to exclude from controls	13.3 Setting Chillers to "Maintenance"
2	Maintenance of equipment	Do needed maintenance of equipment	- Not done from iCM
3	Set equipment as Available	After needed maintenance is done, set equipment as "Available" from iCM to be included by controls.	13.3 Setting Chillers to "Maintenance"

7.4.2. HVAC System Component Change

Table 15 illustrates steps for HVAC system component change.

Table 15 Workflow for HVAC System Component Change

Step	Name	Description	Reference chapter
1	Password input	Input password to show service menu	8.1 Password Input
2	Source of input setting	Change source of input for ON/OFF signal to manual if necessary in order to stop the system	9.7 Source of Input Setting
3	Stop the system	Stop the system from HMI	13 Operation
4	Set system to Config Mode	Set system to Config Mode to enable equipment registration etc	8.2 Setting System to Config Mode
5	Equipment registration	Registration of new equipment or unregister unnecessary equipment	8.4 Equipment Registration
6	Equipment Configuration	Initial setting for each of the new equipment	8.5 Equipment Configuration
7	Equipment control setting	Setting of parameters for equipment control (e.g. chiller staging, pump VFD control etc)	9 Equipment Control Setting
8	Trial run	Send command to each equipment to check connection	10 Trial Run
9	Backup configuration	Backup configuration data to SD card	11 Saving / Loading Configuration Data
10	Unset Config Mode	Unset system from config mode to enable system operation	8.2 Setting System to Config Mode

8. Configuration

Menu structure of related screens is shown below.



- MainMenu
 - Password..... Input screen for password to show hidden menu
 - ConfigMode Set system to Config Mode in order to do initial configuraiton

8.1. Password Input

Steps for inputting the password to show normally hidden menu are described below.

1. Press the Home Button  to show the “MainMenu” screen.



	MainMenu	1/4
Status		▶
Setting		▶
ConfigMode		▶
Password		▶

2. On the “MainMenu” screen, turn the click-dial  to select “Password” menu then press down on the click-dial  to jump to “Password” screen.



	MainMenu	4/4
Status		▶
Setting		▶
ConfigMode		▶
Password		▶

3. On the “Password” screen, turn the click-dial  to select “Enter Password” menu then press down on the click-dial  to jump to “Enter Password” screen.

	Password	1/2
Enter Password		▶
Close Account		▶

- On the “Enter Password” screen, turn the click-dial  to select “Entry” menu then press down on the click-dial  to jump to input mode screen for “Entry”.

Enter Password	2/2
Entry	****

- On the input mode screen for “Entry”, for each of the four digits of the password, turn the click-dial  to change value and press down on the click-dial  to validate your command.

When all four digits have been input, the screen will automatically jump to “MainMenu”.

Note: If 10 minutes pass without any user operation, the system automatically logs out from password login and the password needs to be input again to log in. Log out can be done manually by entering 0000 as the password.

8.2. Setting System to Config Mode

To do initial configuration such as registering equipment and sending command to equipment manually for trial run purposes, iCM needs to be put into “Config Mode”

Note: To put iCM into “Config Mode” system ON/OFF status needs to be OFF. Also while in “Config Mode”, you cannot change the system status to ON as displayed in Figure 10.

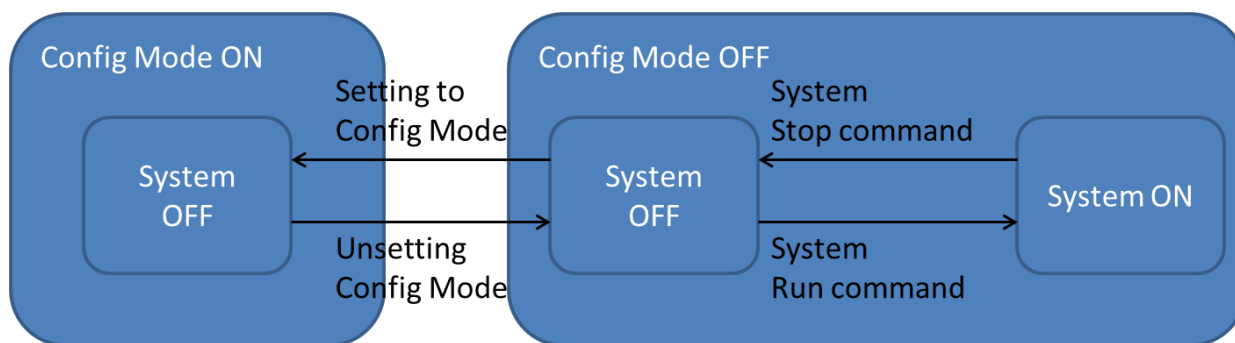



Figure 10 System Status Transition

Steps for putting iCM to “Config Mode” are described below.



- Press the Home Button  to show the “MainMenu” screen.

MainMenu	1/4
Status	▶
Setting	▶
ConfigMode	▶
Password	▶



- On the “MainMenu” screen, turn the click-dial  to select “ConfigMode” menu then press down on the click-dial  to jump to “ConfigMode” screen.

MainMenu	3/4
----------	-----

Status	▶
Setting	▶
ConfigMode	▶
Password	▶

3. On the “ConfigMode” screen, turn the click-dial  to select “ConfigMode” menu then press down on the click-dial  to jump to input mode screen for “ConfigMode” menu.

ConfigMode	1/8
ConfigMode	OFF
SystemSetting	▶
DeviceRegistration	▶
DeviceConfig	▶

4. On the input mode screen for “ConfigMode” menu, turn the click-dial  to select “ON” then press down on the click-dial  to validate the command.

ConfigMode	1/1
ConfigMode	OFF



ConfigMode	1/1
ConfigMode	ON

8.3. System Configuration Setting

Various parameters related to iCM system such as language setting, unit settings can be done from system setting menu.

Menu structure and items which can be set are described below.



<ul style="list-style-type: none"> ❑ MainMenu <ul style="list-style-type: none"> ○ ConfigMode <ul style="list-style-type: none"> ▪ SystemSetting
<ul style="list-style-type: none"> ❑ SystemSetting <ul style="list-style-type: none"> ○ Language.....Switch between Japanese/English ○ UnitSwitch between Metric / imperial unit system ○ Date / ClockSet date, time, and UTC time difference setting ○ NetworkSet network related settings <ul style="list-style-type: none"> ▪ MainController.....Set IP address, DHCP, G/W, subnet mask, and cloud ▪ BACneModuleSet IP address, DHCP, G/W, subnet mask, and device ID ▪ CloudSet password ○ AboutAbout iCM

8.3.1. Setting Unit

Steps for changing current time / date settings are described below.

1. Press the Home Button  to show the "MainMenu" screen.



	MainMenu	1/4
Status		▶
Setting		▶
ConfigMode		▶
Password		▶

2. On the "MainMenu" screen, turn the click-dial  to select "Setting" menu then press down on the click-dial  to jump to "Setting" screen.



	MainMenu	2/4
Status		▶
Setting		▶
ConfigMode		▶
Password		▶

3. On the “Setting” screen, turn the click-dial  to select “SystemSetting” menu then press down on the click-dial  to jump to “System Setting” screen.

Setting	4/5
SystemCtrlParam	▶
DeviceCtrlParam	▶
CtrlModeSetting	▶
SystemSetting	▶

4. On the “System Setting” screen, turn the click-dial  to select “Unit” menu, then press down on the click-dial  to jump to input mode screen for “Unit” menu.

SystemSetting	2/5
Language	English
Unit	Metric
Date/Clock	▶
Network	▶



5. On the input mode screen for “Unit” menu, turn the click-dial  to select “Metric” or “Imperial” then press down on the click-dial  to validate the command.

Unit	1/1
Unit	Metric
	
ConfigMode	1/1
Unit	Imperial

8.3.2. Setting Current Time / Date

(Used screen: MainMenu → ConfigMode → Setting → System Setting → Date/Clock)

Steps for changing current time / date settings are described below.

1. On the “Date/Clock” screen, turn the click-dial  to select “Setting” menu then press down on the click-dial  to jump to “Date/Clock Setting” screen.

	Date/Clock	1/4
	Setting	▶
	Date(M/D/Y)	01/16/2015
	Time(H:M:S)	17:33:25
	UTC_TimeDiff	-360min

2. On the “Date/Clock Setting” screen, date and clock setting for the controller can be changed.

	Date/Clock Setting	1/4
	Date(M/D/Y)	01/16/2015
	Time(H:M:S)	17:33:25
	UTC_TimeDiff	-360min
	Reset	-



8.3.3. Changing Network Setting of Main Controller

(Used screen: MainMenu → ConfigMode → Setting → System Setting → Network)

Steps for changing network settings are described below.

- On the “Network” screen, current setting for network related setting of the Main controller can be checked.



	Network	1/12
	MainController	
	-Setting	▶
	-IP	192.168.0.3
	-Mask	255.255.255.0
	-G/W	192.168.0.1
	-DHCP	Passive
	BACnet_Module	
	-Status/Setting	▶
	Daikin On Site	
	-Status	▶
	HMIforWeb	
	-Status	▶

- On the “Network” screen turn the click-dial  to select “Setting” menu under “MainController” then press down on the click-dial  to jump to “MainController Network” screen.



Network	2/12
MainController	
-Setting	▶
-IP	192.168.0.3
-Mask	255.255.255.0
-G/W	192.168.0.1
-DHCP	Passive
BACnet_Module	
-Status/Setting	▶
Daikin On Site	
-Status	▶
HMIforWeb	
-Status	▶

- On the “MainController Network” screen, network related setting for the main controller can be changed.

Main Network	1/8
Gvn IP	192.168.0.9
Gvn Mask	255.255.255.0
Gvn G/W	192.168.0.13
DHCP	Passive
PrimDNS	000.000.000.000
SecDNS	000.000.000.000
MAC	00-00-00-00-00-00
Reset	-

- After setting is complete, it is required to reset the controller to reflect the setting. On the “MainController Network” screen, turn the click-dial  to select “Reset” menu then press down on the click-dial  to jump to input mode screen for “Reset”

Main Network	8/8
Gvn IP	192.168.0.130
Gvn Mask	255.255.255.0
Gvn G/W	192.168.0.254
DHCP	Passive
PrimDNS	000.000.000.000
SecDNS	000.000.000.000
MAC	00-00-00-00-00-00
Reset	-

- On the input mode screen for “Reset”, turn the click-dial  to change value to “Reset” then press down on the click-dial  to validate your setting. The controller will restart and your settings will be reflected.

Caution: By resetting the controller, the system will stop until the controller has finished restarting.



8.3.4. Changing Network Setting of BACnet Module

(Used screen: MainMenu → ConfigMode → Setting → System Setting → Network)

Steps for changing current BACnet settings are described below. Make sure the BACnet Module is connected correctly before changing the network setting.

1. On the “Network” screen, current setting for network related setting of BACnet Module can be checked.

Network	1/12
MainController	
-Setting	▶
-IP	192.168.0.3
-Mask	255.255.255.0
-G/W	192.168.0.1
-DHCP	Passive
BACnet_Module	
-Status/Setting	▶
Daikin On Site	
-Status	▶
HMIforWeb	
-Status	▶

2. On the “Network” screen turn the click-dial  to select “Setting” menu under “BACnetModule” then press down on the click-dial  to jump to “BACnet NetworkSetting” screen.

Network	8/12
MainController	
-Setting	▶
-IP	192.168.0.3
-Mask	255.255.255.0
-G/W	192.168.0.1
-DHCP	Passive
BACnet_Module	
-Status/Setting	▶
DaikinOnSite	
-Status	▶
HMIforWeb	
-Status	▶

3. On the “BACnet NetworkSetting” screen, network related setting for the BACnet Module can be changed.

BACnet IP Card	1/19
State	Hardware
Comm Failure	Active
BACnet:	
Device name	

-	
Device ID	1
Port	0
TCP/IP	
DHCP	Passive
Actual IP	192.168.0.9
Actual Mask	255.255.255.0
Act Gateway	192.168.0.13
Given IP	192.168.0.9
Given Mask	255.255.255.0
Giv Gateway	192.168.0.13
Write settings	Passive
General	
Software Version	
Reset	-





Note: To overwrite the current settings “Write settings” must be turned into “Active”, before resetting the controller.

BACnet IP Card	19/19
Write settings	Active
General	
Software Version	
Reset	-

- After setting is complete, it is required to reset the controller to reflect the setting.

8.3.5. Changing Network Setting of Daikin On Site (DoS: Cloud Connection)



(Used screen: MainMenu → ConfigMode → Setting → System Setting → Network)

- On the “Network” screen turn the click-dial  to select “DaikinOnSite” then press down on the click-dial  to jump to input mode screen for “DaikinOnSite”
On the input mode screen for “DaikinOnSite”, turn the click-dial  to change value to “Enable” then press down on the click-dial  to validate your setting.

Network	1/1
DaikinOnSite	Disabled



Network	1/1
DaikinOnSite	Enable

- On the “Network” screen turn the click-dial  to select “Status” menu under “Daikin On Site” then press down on the click-dial  to jump to “Cloud Status” screen.



Network	15/17
MainController	
-Setting	▶
-IP	192.168.0.3
-Mask	255.255.255.0
-G/W	192.168.0.1
-DHCP	Passive
BACnet_Module	
-Status/Setting	▶
Daikin on Site	Enable
-Status	▶
HMIforWeb	Enable
-Status	▶



Daikin On Site Status	1/8
ComState	-
CCLState	-
Activation Key	
XCHE-CNBI-NCAJ...	

8.3.6. Showing information of iCM

(Used screen: MainMenu → ConfigMode → Setting → System Setting)

1. On the “System Setting” screen, turn the click-dial  to select “About” menu, then press down on the click-dial  to jump to input mode screen for “About” menu.

	SystemSetting	5/5
Unit		Metric
Date/Clock		▶
Network		▶
About		▶

2. The “About” menu displays versions of iCM and BSP.

	About	1/3
iCM		-
-Application	iCM	
-Date	dd/mm/yyyy	
-Version	2.**.**	
	iCM_Ver_2.**.**	
HMI		-
-Verson		
	iCMd_Ver2.**.**	
-GUID		
	4518B7BC-69D9-43A9-ABF0-945...	
Controller		
-BSP	10.36	
-SerialNr	9554	

8.4. Equipment Registration

Number and types of equipment which are controlled from iCM can be set from equipment registration menu.

Menu structure and items which can be set are described below.

<ul style="list-style-type: none"> ❑ MainMenu <ul style="list-style-type: none"> ○ ConfigMode <ul style="list-style-type: none"> ▪ DeviceRegistration
<ul style="list-style-type: none"> ❑ DeviceRegistration <ul style="list-style-type: none"> ○ Chiller Register available chillers ○ PrimaryPump Register available primary pumps ○ CondenserPump Register available condenser pumps ○ CTBypassValve Register available CT bypass valves ○ Sensors Register available sensors ○ Extl/O Register available ext. modules ○ BACnet_Module Register availability of BACnet module

1. Press the Home Button  to show the “MainMenu” screen.

MainMenu	1/4
Status	▶
Setting	▶
ConfigMode	▶
Password	▶

2. On the “MainMenu” screen, turn the click-dial  to select “ConfigMode” menu then press down on the click-dial  to jump to “ConfigMode” screen.

MainMenu	3/4
Status	▶
Setting	▶
ConfigMode	▶
Password	▶



3. On the “Setting” screen, turn the click-dial  to select “DeviceRegistration” menu then press down on the click-dial  to jump to “DeviceRegistration” screen.

	ConfigMode	3/8
	ConfigMode	▶
	SystemSetting	▶
	DeviceRegistration	▶
	DeviceConfig	▶

4. “DeviceRegistration” screen is shown. From this screen, you can register different equipment

	DeviceRegistration	1/14	
	Chiller	▶	← 8.4.1 Chiller Registration
	PrimaryPump	▶	← 8.4.2 PrimaryPump Registration
	CondenserPump	▶	← 8.4.3 CondenserPump Registration
	CTBypassValve	▶	← 8.4.4 CTBypassValve Registration
	Sensors	▶	← 8.4.5 Sensors Registration
	ExtI/O	▶	← 8.4.6 ExtI/O Registration
	BACnet_Module	IgnoreCommError	← 8.4.7 BACnet_Module Registration
	Reset	-	



NOTE: After registration of all equipment is complete, it is required to reset the controller to reflect the changes before keeping on configuration.

- On the input mode screen for “Reset”, turn the click-dial  to change value to “Reset” then press down on the click-dial  to validate your setting. The controller will restart and your settings will be reflected.

Caution: By resetting the controller, the system will stop until the controller has finished restarting.

8.4.1. Chiller Registration

(Used screen: MainMenu > ConfigMode > DeviceRegistration > Chiller Registration)

- From “DeviceRegistration” screen, turn the click-dial  to select “Chiller” menu then press down on the click-dial  to jump to “Chiller Registration” screen.

DeviceRegistration	1/9
Chiller	▶
PrimaryPump	▶
CondenserPump	▶
CTBypassValve	▶

- “Chiller Registration” screen is displayed. Here, maximum of 8 chillers with respective evaporator and condenser side shut-off valves can be registered by setting the value to “Enable”.



Chiller Registration	1/25
-#01	Enable
-EvShutOffValve	Disable
-CndShutOffValve	Disable
-#02	Disable
-EvShutOffValve	Disable
-CndShutOffValve	Disable
-#03	Disable
-EvShutOffValve	Disable
-CndShutOffValve	Disable
-#04	Disable
-EvShutOffValve	Disable
-CndShutOffValve	Disable
-#05	Disable
-EvShutOffValve	Disable
-CndShutOffValve	Disable
-#06	Disable
-EvShutOffValve	Disable
-CndShutOffValve	Disable
-#07	Disable
-EvShutOffValve	Disable
-CndShutOffValve	Disable
-#08	Disable
-EvShutOffValve	Disable
-CndShutOffValve	Disable
Reset	-

NOTE: In case of registration of air-cooled chiller CndShutOffValve must be set “Disable”

8.4.2. PrimaryPump Registration

(Used screen: MainMenu → ConfigMode → DeviceRegistration → PrimaryPump Registration)

NOTE: At least one primary pump (as dummy pump) must be registered, even if iCM does not have any management.

1. From “DeviceRegistration” screen, turn the click-dial  to select “PrimaryPump” menu then press down on the click-dial  to jump to “PriPump Registration” screen.

	DeviceRegistration	2/9
	Chiller	▶
	PrimaryPump	▶
	CondenserPump	▶
	CTBypassValve	▶

2. “PriPump Registration” screen is displayed. Here, maximum of 8 primary pumps can be registered by setting the value to “Enable”.



	PriPump Registration	1/9
	-#01	Enable
	-#02	Disable
	-#03	Disable
	-#04	Disable
	-#05	Disable
	-#06	Disable
	-#07	Disable
	-#08	Disable
	Reset	-

8.4.3. CondenserPump Registration

(Used screen: MainMenu → ConfigMode → DeviceRegistration → CondenserPump)

NOTE: This menu displays on HMI, but hardware of models EKDICMPA* does not support this function.

NOTE: At least one condenser pump (as dummy pump) must be registered, even in case of air-cooled chiller plant room

1. From “DeviceRegistration” screen, turn the click-dial  to select “CondenserPump” menu then press down on the click-dial  to jump to “CondenserPump Registration” screen.

	DeviceRegistration	3/9
	Chiller	▶
	PrimaryPump	▶
	CondenserPump	▶
	CTBypassValve	▶



2. “CondenserPump Registration” screen is displayed. Here, maximum of 8 condenser pumps can be registered by setting the value to “Enable”.

	CondenserPump Registration	1/9
-#01		Enable
-#02		Disable
-#03		Disable
-#04		Disable
-#05		Disable
-#06		Disable
-#07		Disable
-#08		Disable
Reset		-

8.4.4. CTBypassValve Registration

(Used screen: MainMenu → ConfigMode → DeviceRegistration → CTBypassValve)

NOTE: This menu displays on HMI, but hardware of models EKDICMPA* does not support this function.

1. From “DeviceRegistration” screen, turn the click-dial  to select “CTBypassValve” menu then press down on the click-dial  to jump to “CTBypassValve Registration” screen.



	DeviceRegistration	4/9
Chiller		▶
PrimaryPump		▶
CondenserPump		▶
CTBypassValve		▶

2. “CTBypassValve Registration” screen is displayed. Here, maximum of 4 cooling tower bypass valves can be registered by setting the value to “Enable”.

	CTBypassValve Registration	1/5
-#01		Enable
-#02		Disable
-#03		Disable
-#04		Disable
Reset		-

8.4.5. Sensors Registration

(Used screen: MainMenu → ConfigMode → DeviceRegistration)

- From “DeviceRegistration” screen, turn the click-dial  to select “Sensors” menu then press down on the click-dial  to jump to “Sensors Registration” screen.

	DeviceRegistration	5/9
	CTBypassValve	▶
	Sensors	▶
	Extl/O	▶
	-Reset	



- “Sensors Registration” screen is displayed. Here, sensors for each of the condenser piping groups (up to four) can be registered by setting the value to “Enable”.

	Sensors Registration	1/18
	OutdoorTemp	Enable
	CndPipingGroup1	
	-CndWtLvgTemp	Disable
	-CndWtEntTemp	Disable
	-CndDiffPress	Enable
	CndPipingGroup2	
	-CndWtLvgTemp	Disable
	-CndWtEntTemp	Disable
	-CndDiffPress	Disable
	CndPipingGroup3	
	-CndWtLvgTemp	Disable
	-CndWtEntTemp	Disable
	-CndDiffPress	Disable
	CndPipingGroup4	
	-CndWtLvgTemp	Disable
	-CndWtEntTemp	Disable
	-CndDiffPress	Disable
	Reset	Reset

NOTE: This menu displays on HMI, but hardware of models EKDICMPA* does not support this function.

8.4.6. ExtI/O Registration

(Used screen: MainMenu → ConfigMode → DeviceRegistration)

- From “DeviceRegistration” screen, turn the click-dial  to select “ExtI/O” menu then press down on the click-dial  to jump to “ExtI/O Registration” screen.

	DeviceRegistration	6/9
	CTBypassValve	▶
	Sensors	▶
	ExtI/O	▶
	-Reset	

- From “ExtI/O Registration” screen, availability of 8 ExtI/O modules can be set. If ExtI/O is set as available but connection is not found, iCM will be in alarm status.

	ExtI/O Registration	1/18	
-#01	Disable		← Availability of ExtIO #1
-#02	Disable		← Availability of ExtIO #2
-#03	Disable		← Availability of ExtIO #3
-#04	Disable		← Availability of ExtIO #4
-#05	Disable		← Availability of ExtIO #5
-#06	Disable		← Availability of ExtIO #6
-#09	Disable		← Availability of ExtIO #9
-#10	Disable		← Availability of ExtIO #10
-#11	Disable		← Availability of ExtIO #11
-#12	Disable		← Availability of ExtIO #12
-#13	Disable		← Availability of ExtIO #13
-#14	Disable		← Availability of ExtIO #14
-#15	Disable		← Availability of ExtIO #15
-#16	Disable		← Availability of ExtIO #16
-Reset	-		

8.4.7. BACnet_Module Registration

(Used screen: MainMenu → ConfigMode → DeviceRegistration)

1. From “DeviceRegistration” screen, availability of BACnet module can be set. If BACnet is set as available but connection is not found, iCM will be in alarm status.

	DeviceRegistration	8/9
	PrimaryPump	▶
	ExtI/O	▶
	-Reset	
	BACnet_Module	IgnoreCommError

← Availability of BACnet Module

8.5. Equipment Configuration

Initial setting of attributes for each equipment can be done from this menu. Menu structure and items which can be set are described below.



<ul style="list-style-type: none"> □ MainMenu <ul style="list-style-type: none"> ○ Config <ul style="list-style-type: none"> ▪ DeviceConfig
<ul style="list-style-type: none"> □ DeviceConfig <ul style="list-style-type: none"> ○ System.....Set temperature setpoint ○ ChillerSet chiller type, capacity, run hours ○ EvShutOffValveSet whether feedback signal is available ○ CndShutOffValveSet availability for condenser pump shutoff valves ○ PrimaryPumpSet run hours, whether feedback signal is available ○ CondenserPumpSet piping groups for condenser pumps ○ SensorSet input type for sensor ○ ModbusCommSettingSet Modbus BaudRate, Parity, Stop Bits, and Time out ○ AiThreshold.....Set threshold for judging open loop of Ai signal

1. Press the Home Button  to show the “MainMenu” screen.

MainMenu	1/4
Status	▶
Setting	▶
ConfigMode	▶
Password	▶

2. On the “MainMenu” screen, turn the click-dial  to select “ConfigMode” menu then press down on the click-dial  to jump to “ConfigMode” screen.

MainMenu	3/4
Status	▶
Setting	▶
ConfigMode	▶
Password	▶



3. On the “Setting” screen, turn the click-dial  to select “DeviceConfig” menu then press down on the click-dial  to jump to “DeviceConfig” screen.

	ConfigMode	3/4
	ConfigMode	▶
	SystemSetting	▶
	DeviceRegistration	▶
	DeviceConfig	▶

4. “DeviceConfig” screen is shown. From this screen, you can do initial setting of equipment.



	DeviceConfig	1/12	
	System	▶	← 8.5.1 System Configuration
	Chiller	▶	← 8.5.2 Chiller Configuration
	EvShutOffValve		← 8.5.3 Evaporator Shut Off Valve Configuration
	-StatusSignal	Avail	← 8.5.4 Condenser Shut Off Valve
	CndShutOffValve		
	-StatusSignal	Avail	
	PrimaryPump	▶	← 8.5.5 Primary Pump
	CondenserPump	▶	← 8.5.6 Condenser Pump
	Sensor	▶	← 8.5.7 Sensor
	ModbusCommSetting	▶	← 8.5.8 Modbus Communication Setting
	AiThreshold		← 8.5.9 Ai Threshold Setting
	-mA	1.0mA	

NOTE: After configuration of all equipment is complete, it is required to reset the controller to reflect the changes before keeping on setting.

- On the input mode screen for “Reset”, turn the click-dial  to change value to “Reset” then press down on the click-dial  to validate your setting. The controller will restart and your settings will be reflected.

8.5.1. System Configuration

(Used screen: MainMenu → ConfigMode → DeviceConfig → System Config)

- From “DeviceConfig” screen, turn the click-dial  to select “System” menu then press down on the click-dial  to jump to “System” screen.

	DeviceConfig	1/12
	System	▶
	Chiller	▶
	EvShutOffValve	
	-StatusSignal	Avail

- “System Config” screen is displayed. Here, you can configure attributes of chillers.



	System Config	1/3
	TempSetPt	
	-MaxOutput	48.9° C ← a.
	-MinOutput	12.2° C ← b.

Table 16 List of parameters which can be set from “Chiller Config” screen

ID	Name	Definition
a.	-MaxOutput	Maximum temperature setpoint of system
b.	-MinOutput	Minimum temperature setpoint of system

8.5.2. Chiller Configuration

(Used screen: MainMenu → ConfigMode → DeviceConfig → Chiller Config)

- From “DeviceConfig” screen, turn the click-dial  to select “Chiller” menu then press down on the click-dial  to jump to “Chiller” screen.

	DeviceConfig	2/12
	System	▶
	Chiller	▶
	EvShutOffValve	
	-StatusSignal	Avail

- “Chiller Config” screen is displayed. Here, you can configure attributes of chillers.

	Chiller Config	1/65
	Status Signal	Avail ← a.
	#01	
	-ChillerType	MQ_GB ← b.
	-CoolingMaxCap	100kW ← c.
	-Runhours	10h ← d.
	-PipingGroup	1 ← e.
	-MinPumpReq	1 ← f.
	-CndPipingGroup	1 ← g.

-CndMinPumpReq	1	← h.
#02		
-ChillerType	MQ_GB	
-CoolingMaxCap	100kW	
-Runhours	10h	
-PipingGroup	1	
-MinPumpReq	1	
-CndPipingGroup	1	
-CndMinPumpReq	1	
#03		
-ChillerType	MQ_GB	
-CoolingMaxCap	100kW	
-Runhours	10h	
-PipingGroup	1	
-MinPumpReq	1	
-CndPipingGroup	1	
-CndMinPumpReq	1	
#04		
-ChillerType	MQ_GB	
-CoolingMaxCap	100kW	
-Runhours	10h	
-PipingGroup	1	
-MinPumpReq	1	
-CndPipingGroup	1	
-CndMinPumpReq	1	
#05		
-ChillerType	MQ_GB	
-CoolingMaxCap	100kW	
-Runhours	10h	
-PipingGroup	1	
-MinPumpReq	1	
-CndPipingGroup	1	
-CndMinPumpReq	1	
#06		
-ChillerType	MQ_GB	
-CoolingMaxCap	100kW	
-Runhours	10h	
-PipingGroup	1	
-MinPumpReq	1	
-CndPipingGroup	1	
-CndMinPumpReq	1	
#07		
-ChillerType	MQ_GB	
-CoolingMaxCap	100kW	
-Runhours	10h	
-PipingGroup	1	
-MinPumpReq	1	
-CndPipingGroup	1	

-CndMinPumpReq	1
#08	
-ChillerType	MQ_GB
-CoolingMaxCap	100kW
-Runhours	10h
-PipingGroup	1
-MinPumpReq	1
-CndPipingGroup	1
-CndMinPumpReq	1

Table 17 List of parameters which can be set from “Chiller Config” screen

ID	Name	Definition
a.	StatusSignal	Availability of feedback signal for chiller ON/OFF status
b.	-ChillerType	Chiller type to decide type of communication protocol
c.	-CoolingMaxCap	Maximum capacity (100% actual capacity) value of chiller
d.	-Runhours	Total run hours of chiller as initial value
e.	PipingGroup	Piping group of chiller to be associated with pumps
f.	MinPumpReq	Minimum number of pumps required from chiller
g.	CndPipingGroup	Piping group of chiller to be associated with condenser pumps
h.	CndMinPumpReq	Minimum number of condenser pumps required from chiller

NOTE: in case no primary pumps or condenser pumps are connected and managed by iCM, user have to set:

- MinPumpReq = 0
- CndMinPumpReq = 0

8.5.3. Evaporator Shut Off Valve Configuration

(Used screen: MainMenu → ConfigMode → DeviceConfig)

- From “DeviceConfig” screen, you can configure availability of feedback signal for valve Open/Close status.

DeviceConfig	4/12
Chiller	▶
EvShutOffValve	
-StatusSignal	Avail
CndShutOffValve	

8.5.4. Condenser Shut Off Valve Configuration

(Used screen: MainMenu → ConfigMode → DeviceConfig)

NOTE: This menu displays, but hardware of models EKDICMPA* does not support this function.



- From “DeviceConfig” screen, you can configure availability of feedback signal for valve Open/Close status.

DeviceConfig	6/12
EvShutOffValve	
-StatusSignal	Avail
CndShutOffValve	
-StatusSignal	Avail

NOTE: with models EKDICMPA* “StatusSignal” must be set as “Not Avail”.

8.5.5. Primary Pump Configuration

(Used screen: MainMenu → ConfigMode → DeviceConfig → PrimaryPump Config)

- From “DeviceConfig” screen, turn the click-dial  to select “PrimaryPump” menu then press down on the click-dial  to jump to “PrimaryPump” screen.

DeviceConfig	7/12
PrimaryPump	▶
CondenserPump	▶
Sensor	▶
ModbusCommSetting	▶

- “PrimaryPump Config” screen is displayed. Here, you can configure attributes of primary pumps.

PrimaryPump Config	1/25	
StatusSignal	Avail	← a.
#01		
-Runhours	10h	← b.
-PipingGroup	1	← c.
#02		
-Runhours	10h	
-PipingGroup	1	
#03		
-Runhours	10h	
-PipingGroup	1	
#04		
-Runhours	10h	
-PipingGroup	1	
#05		
-Runhours	10h	
-PipingGroup	1	
#06		
-Runhours	10h	
-PipingGroup	1	
#07		
-Runhours	10h	
-PipingGroup	1	
#08		

-Runhours	10h
-PipingGroup	1



Table 18 List of parameters which can be set from “PrimaryPump Config” screen

ID	Name	Definition
a.	StatusSignal	Availability of feedback signal for pump ON/OFF status
b.	-Runhours	Total run hours of pump as initial value
c.	-PipingGroup	Piping group the pump belongs to

8.5.6. Condenser Pump Configuration

(Used screen: MainMenu → ConfigMode → DeviceConfig → CondenserPump Config)

NOTE: This menu displays, but hardware of models EKDICMPA* does not support this function.

- From “DeviceConfig” screen, turn the click-dial  to select “CondenserPump” menu then press down on the click-dial  to jump to “CondenserPump” screen.

DeviceConfig	7/12
PrimaryPump	▶
CondenserPump	▶
Sensor	▶
ModbusCommSetting	▶

- “CondenserPump Config” screen is displayed. Here, you can configure attributes of condenser pumps.

CondenserPump Config	1/25	
StatusSignal	Avail	← a.
#01		
-Runhours	10h	← b.
-PipingGroup	1	← c.
#02		
-Runhours	10h	
-PipingGroup	1	
#03		
-Runhours	10h	
-PipingGroup	1	
#04		
-Runhours	10h	
-PipingGroup	1	
#05		
-Runhours	10h	
-PipingGroup	1	
#06		
-Runhours	10h	
-PipingGroup	1	

#07	
-Runhours	10h
-PipingGroup	1
#08	
-Runhours	10h
-PipingGroup	1



NOTE: with models EKDICMPA* “StatusSignal” must be set as “Not Avail”.

Table 19 List of parameters which can be set from “CondenserPump Config” screen

ID	Name	Definition
a.	StatusSignal	Availability of feedback signal for pump ON/OFF status
b.	-Runhours	Total run hours of pump as initial value
c.	-PipingGroup	Piping group the pump belongs to

8.5.7. Sensor Configuration

(Used screen: MainMenu → ConfigMode → DeviceConfig → SensorConfig)

- From “DeviceConfig” screen, turn the click-dial  to select “Sensor” menu then press down on the click-dial  to jump to “SensorConfig” screen.

	Device Config	9/12
	PrimaryPump	▶
	CondenserPump	▶
	Sensor	▶
	ModbusCommSetting	▶

- “SensorsConfig” menu is displayed. Here you can set attributes of sensors
Note: sensor type for differential pressure sensor is fixed to mA type.

	SensorsConfig	1/12	
	ChWtLvlgTemp		
	-PortType	mA	← a.
	ChWtEntTemp		
	-Porttype	mA	← b.
	CndWtLvlgTemp		
	-PortType	mA	← c.
	CndWtEntTemp		
	-Porttype	mA	← d.
	OATemp		
	-PortType	mA	← e.
	SensorConversionParam	▶	← 8.5.7.1 Setting sensor conversion parameter when using mA type
	NTCSensorConversionPara	▶	← 8.5.7.2 Setting sensor conversion parameter when using NTC10K type
	m		

Table 20 List of parameters which can be set from “SensorsConfig” screen

ID	Name	Definition
a.	-PortType	PortType for Chilled Water Leaving Temperature sensor (mA / NTC10K)
b.	-PortType	PortType for Chilled Water Entering Temperature sensor (mA / NTC10K)
c.	-PortType	PortType for Condensed Water Leaving Temperature sensor (mA / NTC10K)
d.	-PortType	PortType for Condensed Water Entering Temperature sensor (mA / NTC10K)
e.	-PortType	PortType for Outdoor Air Temperature sensor (mA / NTC10K)

NOTE: Chilled Water temperature sensor are NTC10K sensors and are supplied with panel.

NOTE: Condenser Water Temperature sensors setting display, but hardware of models EKDICMPA* does not support this equipment

8.5.7.1. Setting sensor conversion parameter when using mA type

Image of sensor conversion when using mA type is shown on Figure 11.

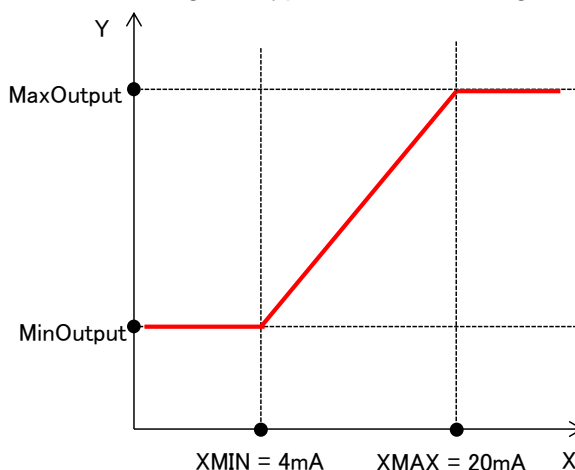



Figure 11 Sensor value conversion of 4-20mA

- From “MainMenu > ConfigMode > SensorsConfig” screen, turn the click-dial  to select “SensorConversionParam” menu then press down on the click-dial  to jump to “SensorConvParam” screen.

SensorsConfig	11/12
OATemp	
-Porttype	mA
SensorConversionParam	▶
NTCSensorConversionPara	▶
m	

- “SensorConvParam” screen is shown. Here, parameters for conversion of mA sensor input can be done

SensorConvParam		1/21
ChWtLvgTemp		
-MaxOutput	75.0° C	a.
-MinOutput	-25.0° C	b.
ChWtEntTemp		
-MaxOutput	75.0° C	c.
-MinOutput	-25.0° C	d.
DiffPress		
-MaxOutput	683kPa	e.
-MinOutput	0kPa	f.
CndWtLvgTemp		
-MaxOutput	75.0° C	g.
-MinOutput	-25.0° C	h.
CndWtEntTemp		
-MaxOutput	75.0° C	i.
-MinOutput	-25.0° C	j.
CndDiffPress		
-MaxOutput	683kPa	k.
-MinOutput	0kPa	l.
OATemp		
-MaxOutput	75.0° C	m.
-MinOutput	-25.0° C	n.

Table 21 List of parameters which can be set from “SensorConvParam” screen

ID	Name	Definition
a.	-MaxOutput	Linear output value of chilled water leaving temperature corresponding to 20mA input
b.	-MinOutput	Linear output value of chilled water leaving temperature corresponding to 4mA input
c.	-MaxOutput	Linear output value of chilled water entering temperature corresponding to 20mA input
d.	-MinOutput	Linear output value of chilled water entering temperature corresponding to 4mA input
e.	-MaxOutput	Linear output value of differential pressure corresponding to 20mA input
f.	-MinOutput	Linear output value of differential pressure corresponding to 4mA input
g.	-MaxOutput	Linear output value of condensed water leaving temperature corresponding to 20mA input
h.	-MinOutput	Linear output value of condensed water leaving temperature corresponding to 4mA input
i.	-MaxOutput	Linear output value of condensed water entering temperature corresponding to 20mA input
j.	-MinOutput	Linear output value of condensed water entering temperature corresponding to 4mA input

k.	-MaxOutput	Linear output value of condenser differential pressure corresponding to 20mA input
l.	-MinOutput	Linear output value of condenser differential pressure corresponding to 4mA input
m.	-MaxOutput	Linear output value of outdoor air temperature corresponding to 20mA input
n.	-MinOutput	Linear output value of outdoor air temperature corresponding to 4mA input

8.5.7.2. Setting sensor conversion parameter when using NTC10K type

Image of sensor conversion when using mA type is shown on Figure 11.

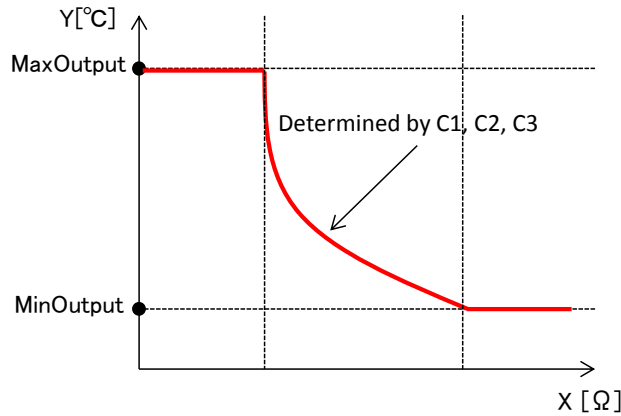

Figure 12 Sensor value conversion of NTC10K

The non-linear part of conversion is modelled by Steinhart-Hart equation as described below. Parameters C1, C2, C3 are required to be set to determine the shape of the equation.

$$Temperature\ output = \frac{1}{C_1 \times 10^{-4} + C_2 \times 10^{-4} \times \ln(x) + C_3 \times 10^{-8} \times \ln(x)^3 - 273.15}$$

Equation 1 Steinhart-Hart Equation

- From “MainMenu > ConfigMode > SensorsConfig” screen, turn the click-dial to select “NTCSensorConversionParam” menu then press down on the click-dial to jump to “NTCSensorConvParam” screen.

SensorsConfig	6/6
OATemp	
-Porttype	mA
SensorConversionParam	▶
NTCSensorConversionParam	▶

- “SensorConvParam” screen is shown. Parameters for conversion of NTC sensor input can be done.

NTCSensorConvParam	1/30
--------------------	------

ChWtLvgTemp		
-C1 E-4	11.3510	← a.
-C2 E-4	2.3296	← b.
-C3 E-8	9.3665	← c.
-MaxOutput	75.0° C	← d.
-MinOutput	-25.0° C	← e.
ChWtEntTemp		
-C1 E-4	11.3510	
-C2 E-4	2.3296	
-C3 E-8	9.3665	
-MaxOutput	75.0° C	
-MinOutput	-25.0° C	
CndWtLvgTemp		
-C1 E-4	11.3510	
-C2 E-4	2.3296	
-C3 E-8	9.3665	
-MaxOutput	75.0° C	
-MinOutput	-25.0° C	
CndWtEntTemp		
-C1 E-4	11.3510	
-C2 E-4	2.3296	
-C3 E-8	9.3665	
-MaxOutput	75.0° C	
-MinOutput	-25.0° C	
OATemp		
-C1 E-4	11.3510	
-C2 E-4	2.3296	
-C3 E-8	9.3665	
-MaxOutput	75.0° C	
-MinOutput	-25.0° C	



Table 22 List of parameters which can be set from “NTCSensorConvParam” screen

ID	Name	Definition
a.	-C1 E-4	Steinhart-Hart coefficient
b.	-C2 E-4	Steinhart-Hart coefficient (ln(X) term)
c.	-C3 E-8	Steinhart-Hart coefficient (ln(X)^3 term)
d.	-MaxOutput	Maximum output value
e.	-MinOutput	Minimum output value

NOTE: The default values refer to NTCK10 sensor supplied with panel.

8.5.8. Modbus Communication Setting

(Used screen: MainMenu → ConfigMode → DeviceConfig → ModbusCommSetting)

1. From “DeviceConfig” screen, turn the click-dial  to select “ModbusCommSetting” menu then press down on the click-dial  to jump to “ModbusCommSetting” screen.

DeviceConfig	10/12
PrimaryPump	▶
CondenserPump	▶
Sensor	▶
ModbusCommSetting	▶

2. “ModbusCommSetting” screen is displayed. Here, you can configure Modbus communication between iCM and chiller.

ModbusCommSetting	1/4	
BaudRate	19200bps	← a.
Parity	None	← b.
StopBits	1bit	← c.
ResponseTimeout	1000ms	← d.

Table 23 List of parameters which can be set from “ModbusCommSetting” screen

ID	Name	Definition
a.	BaudRate	Baud rate setting of RS485
b.	Parity	Parity bit setting of RS485
c.	StopBits	Stop bit setting of RS485
d.	ResponseTimeout	Wait time for response on each command before time out

NOTE: Modbus communication parameter must match with Communication setting on chiller controller

8.5.9. Ai Threshold Setting

(Used screen: MainMenu → ConfigMode → DeviceConfig)

You can set threshold for judging open loop of Ai signal. The setting is common for all Ai signal. If open loop is detected, iCM will be in alarm status.

	DeviceConfig	12/12
	Sensor	▶
	ModbusCommSetting	▶
	AiThreshold	
	-mA	1.0mA ← a.

Table 24 List of parameters which can be set from “DeviceConfig” screen

ID	Name	Definition
a.	-mA	Threshold for detecting open loop. If Input is less that this value, it is considered open loop.

NOTE: If users want to disable open loop detection for Ai signal, set “0.0mA” to this parameter.



9. Equipment Control Setting

Setting of various control parameters for each equipment can be done from this menu. Menu structure and items which can be set are described below.

<ul style="list-style-type: none"> □ MainMenu <ul style="list-style-type: none"> ○ Setting <ul style="list-style-type: none"> ▪ DeviceCtrlParam
<ul style="list-style-type: none"> □ DevcieCtrlParam <ul style="list-style-type: none"> ○ ChillerSet sequencing type, staging type, min/max operating chillers etc ○ PrimaryPumpSet PI parameters, setpoint etc for pump VFD control ○ BypassValveSet PI parameters, setpoint etc for bypass valve control ○ CondenserPumpSet PI parameters, setpoint etc for pump VFD control ○ CTBypassValveSet PI parameters, setpoint etc for bypass valve control

1. Press the Home Button  to show the “MainMenu” screen.

MainMenu	1/4
Status	▶
Setting	▶
ConfigMode	▶
Password	▶

2. On the “MainMenu” screen, turn the click-dial  to select “Setting” menu then press down on the click-dial  to jump to “Setting” screen.

MainMenu	2/4
Status	▶
Setting	▶
ConfigMode	▶
Password	▶

3. On the “Setting” screen, turn the click-dial  to select “DeviceCtrlParam” menu then press down on the click-dial  to jump to “DeviceCtrlParam” screen.



Setting	2/5
SystemCtrlParam	▶
DeviceCtrlParam	▶
CtrlModeSetting	▶
SystemSetting	▶

4. DeviceCtrlParam screen is shown. From this screen, you can jump to control parameter setting for different equipment.

DeviceCtrlParam		1/5
Chiller	▶	← 9.1 Chiller Control Setting
PrimaryPump	▶	← 9.2 Primary Pump Control Setting
BypassValve	▶	← 9.3 Bypass Valve Control Setting
CondenserPump	▶	← 9.4 Condenser Pump Control Setting
CTBypassValve	▶	← 9.5 Cooling Tower Bypass Valve Control Setting

9.1. Chiller Control Setting

(Used screen: MainMenu > Setting > DeviceCtrlParam > ChillerCtrlParam)

- From “MainMenu > Setting > DeviceCtrlParam” screen, turn the click-dial  to select “Chiller” menu then press down on the click-dial  to jump to “ChillerCtrlParam” screen.

DeviceCtrlParam		1/5
Chiller		▶
PrimaryPump		▶
BypassValve		▶
CondenserPump		▶

- “ChillerCtrlParam” screen is displayed. Here, various options for chiller control can be set.

Chiller Ctrl		1/20	
Sequencing			
-Type	FixedOrder		← a.
-Order		▶	← 9.1.1 Setting sequence order when using fixed order sequencing
-PonyChCtl	Disable		← b.
-PonyChNo	1		← c.
-StgDnWaitTime	5min		← d.
Staging			
-Type	Temp		← e.
-StgByTargetLoad	Disable		← f.
-StgForRotation	Disable		← g.
-WaitTime	24h		← h.
-MinRunningCh	1		← i.
-MaxRunningCh	1		← j.
-Detail		▶	← 9.1.2 Setting detailed options for staging up / down
StabilizeTime			
-up-up	5min		← k.
-dn-up	10min		← l.
-dn-dn	3min		← m.
-up-dn	10min		← n.
TempDiff(SoftLoad)	1.0° C		← o.

Table 25 shows the list of parameters which can be set from “ChillerCtrl” screen

Table 25 List of parameters which can be set from “Chiller Ctrl” screen

ID	Name	Range	Definition
a.	-Type	FixedOrder TimeOrder	Type of chiller sequencing (Fixed order / operation hours based)
b.	-PonyChCtl	Enable Disable	Enable / disable pony chiller (Pony chiller is a chiller that operates first and stops when second chiller operates) Note: pony chiller control can only be used when enabling sequencing based on operation hours.
c.	-PonyChNo	1...8	Chiller ID specified as pony chiller
d.	-StgDnWaitTime	1...30 min	Wait time before Pony chiller is staged down after second chiller is staged up.
e.	-Type	Tmp Ld&Tmp	Decide staging type (temperature only / temperature and load)
f.	-StgByTargetLoad	Enable Disable	Enable / disable optimal stage up method in addition to e.Type: temperature and load
g.	-StgForRotation	Enable Disable	Enable / disable periodical staging for rotation
h.	-WaitTime	24...720 h	How long to wait before conducting staging for rotation
i.	-MinRunningCh	1...8	Minimum number of operating chillers setting Note: please set this value smaller than j.
j.	-MaxRunningCh	1...8	Maximum number of operating chillers setting Note: please set this value bigger than i.
k.	-up-up	1...30min	Stablizing (no stage up or stage down) period when staging up after a stage up
l.	-dn-up	1...30min	Stablizing (no stage up or stage down) period when staging up after a stage down
m.	-dn-dn	1...30min	Stablizing (no stage up or stage down) period when staging down after a stage down
n.	-up-dn	1...30min	Stablizing (no stage up or stage down) period when staging down after a stage up
o.	TempDiff(SoftLoad)	0.0...5.0 dK	Temperature differential from temperature setpoint to judge end of initial startup (only related to status display)

9.1.1. Setting sequence order when using fixed order sequencing

When using fixed order staging method, manual order setting for each chiller needs to be done.

1. From “MainMenu > Setting > DeviceCtrlParam > Chiller Ctrl” screen, follow below steps to reach “Chiller FixedOrder” screen. Here, priority of sequence for manual sequencing can be set with 1 being highest priority.

NOTE: If multiple chillers are set as same priority, the sequence of the chillers will be decided according to operation hours among chillers. So chiller with lower operation hours and higher priority is selected for stage up, whereas chiller with lower priority and higher operation hours for stage down.

Chiller Ctrl	3/20
Sequencing	
-Type	FixedOrder
-Order	▶
-PonyChCtl	Disable

↓

Chiller FixedOrder	1/8
#01	1
#02	2
#03	3
#04	4
#05	5
#06	5
#07	5
#08	5

9.1.2. Setting detailed options for staging up / down

1. From “MainMenu > Setting > DeviceCtrlParam > Chiller Ctrl” screen, follow below steps to reach “ChillerStg Detail” screen. Here, detailed settings for each method of staging up / down can be done.

ChillerCtrlParam	14/20
-MinRunningCh	1
-MaxRunningCh	1
-Detail	▶
StabilizeTime	



ChillerStg Detail		1/14
StgByLoadLimit		
-StgUpWaitTime	180s	← a.
-StgDnWaitTime	10min	← b.
-Full/LowLoad Setting		← 9.1.2.1 Setting full / low load for each chiller
StgByTemp		
-StgUpWaitTime	5min	← c.
-StgDnWaitTime	5min	← d.
-StgUpDiff	1.0 dK	← e.
-StgDnDelta	3.5 D°C	← f.
-WaitTime(SuddenLoad)	6min	← g.
-TempDiff(SuddenLoad)	1.0 dK	← h.
StgByTargetLoad		
-TargetLoad	50%	← i.
-StgUpWaitTime	180s	← j.

Table 26 List of parameters which can be set from “Chiller StgUpToOptimal” screen

ID	Name		Definition
a.	-StgUpWaitTime	1...600 sec	Wait time BEFORE stage up based on full load is confirmed
b.	-StgDnWaitTime	1...600 sec	Wait time BEFORE stage down based on low load is confirmed
c.	-StgUpWaitTime	1...30 min	Wait time BEFORE stage up based on chilled water temperature is confirmed
d.	-StgDnWaitTime	1...30 min	Wait time BEFORE stage down based on chilled Delta temperature is confirmed
e.	-StgUpDiff	0.0...5.0 dK	Temperature differential for deciding threshold of stage up based on Supply water temperature
f.	-StgDnDelta	0.0...99.0 D°C	DELTA Temperatura (EWT-LWT) for deciding setpoint below that staging down will be confirmed
g.	-WaitTime(SuddenLoad)	1...30 min	Base Wait time BEFORE stage up based on chilled water temperature (sudden load)
h.	-TempDiff(SuddenLoad)	0.0...5.0 dK	Temperature differential for deciding threshold of staging based on supply water temperature (sudden load)
i.	-TargetLoad	1...100%	Target optimal load target for chiller when using staging up based on optimal chiller load
j.	-StgUpWaitTime	1...600 sec	Wait time BEFORE stage up based on optimal chiller load is confirmed

9.1.2.1. Setting full / low load for each chiller

1. From “MainMenu > Setting > DeviceCtrlParam > ChillerCtrlParam > ChillerStg Detail” screen, follow below steps to reach “Full/LowLoadSetting” screen. Here, full load and low load setting for each chiller can be done.

ChillerStg Detail	4/14
Full/LowLoad Setting	▶
StgByTemp	
-StgUpWaitTime	5min
-StgDnWaitTime	5min





Full/LowLoadSetting	1/24
#01	
-FullLoad	90%
-LowLoad	10%
#02	
-FullLoad	90%
-LowLoad	10%
#03	
-FullLoad	90%
LowLoad	10%
#04	
-FullLoad	90%
-LowLoad	10%
#05	
-FullLoad	90%
-LowLoad	10%
#06	
-FullLoad	90%
-LowLoad	10%
#07	
-FullLoad	90%
-LowLoad	10%
#08	
-FullLoad	90%
-LowLoad	10%

NOTE: Please DO NOT set LowLoad threshold higher than FullLoad threshold.

9.2. Primary Pump Control Setting

(Used screen: MainMenu > Setting > DeviceCtrlParam > PrimaryPump Ctrl)

- From “DeviceCtrlParam” screen, turn the click-dial  to select “PrimaryPump” menu then press down on the click-dial  to jump to “PrimaryPump Ctrl” screen.

DeviceCtrlParam	2/5
Chiller	▶
PrimaryPump	▶
BypassValve	▶
CondenserPump	▶

- “PrimaryPump Ctrl” screen is displayed. Here, various options for primary pump control can be set.

PrimaryPump Ctrl	1/14	
PumpType	CSD	← a.
Setpt	13kPa	← b.
-ActiveValue	13kPa	← c.
VFD_Control		
-MaxCapacity	100%	← d.
-MinCapacity	30%	← e.
-PI_Param	▶	← 9.2.1 Setting PI Parameters for Pump VFD Control
Staging		
-StgUpWaitTime	60s	← f.
-StgDnWaitTime	60s	← g.
-StgUpDiff	20kPa	← h.
-StgDnDiff	20kPa	← i.
-StgForRotation	▶	← 9.2.2 Setting periodical pump staging for rotation
OperationRange	▶	← 9.2.3 Setting minimum / maximum number of operating pumps for each piping group

Table 27 List of Parameters which can be Set from “PrimaryPump Ctrl” screen

ID	Name		Definition
a.	PumpType	VFD CSD	Set to VFD when VFD control of pumps is needed Set to CSD if constant flow is needed
b.	Setpt	1...999 kPa	Target setpoint for VFD / CSD pump control
c.	-ActiveValue		Status display of actual setpoint (for future optimization control)
d.	MaxCapacity	0...100 %	Maximum output for VFD control
e.	MinCapacity	0...100 %	Minimum output for VFD control
f.	-StgUpWaitTime	1...600 sec	Wait time BEFORE stage up is confirmed
g.	-StgDnWaitTime	1...600 sec	Wait time BEFORE stage down is confirmed
h.	-StgUpDiff	0...100 kPa	Pressure differential for deciding threshold of CSD pump staging up
i.	-StgDnDiff	0...100 kPa	Pressure differential for deciding threshold of CSD pump staging down

9.2.1. Setting PI Parameters for Pump VFD Control

- From “MainMenu > Setting > DeviceCtrlParam > PrimaryPump Ctrl” screen, follow below steps to reach “PriPpDiffPress PI_Param” screen. Here, PI parameter for pump VFD control can be set.

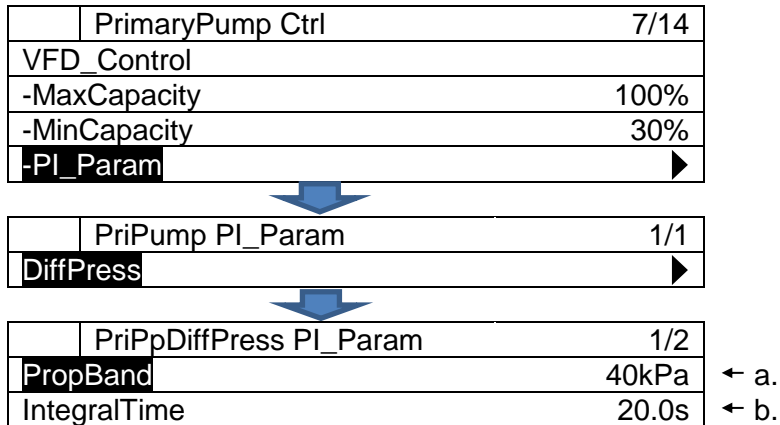



Table 28 List of parameters which can be set from “PrimaryPump Ctrl” screen

ID	Name		Definition
a.	PropBand	0...999 kPa	Proportional band setting of PI control
b.	IntegralTime	0.0...999.0 sec	Integral time setting of PI control

9.2.2. Setting periodical pump staging for rotation

- From “MainMenu > Setting > DeviceCtrlParam > PrimaryPump Ctrl” screen, follow below steps to reach “StgForRotation” screen. Here, periodical pump staging for rotation can be set.

PrimaryPump Ctrl	13/14	
-StgDnWaitTime	60s	
-StgUpDiff	20kPa	
-StgDnDiff	20kPa	
-StgForRotation		▶



StgForRotation	1/8	
PipingGroup01	Disable	← a.
-WaitTime	24h	← b.
PipingGroup02	Disable	
-WaitTime	24h	
PipingGroup03	Disable	
-WaitTime	24h	
PipingGroup04	Disable	
-WaitTime	24h	

Table 29 List of parameters which can be set from “StgForRotation” screen

ID	Name		Definition
a.	PipingGroup[X]	Enable Disable	Enable / disable periodical staging for rotation
b.	-WaitTime	24...720 h	How long to wait before conducting staging for rotation

9.2.3. Setting minimum / maximum number of operating pumps for each piping group

From “MainMenu > Setting > DeviceCtrlParam > PrimaryPump Ctrl” screen, follow below steps to reach “OperationRange” screen. Here, minimum / maximum number of operating pumps for each piping group can be set.

PrimaryPump Ctrl	14/14	
-StgUpDiff	20kPa	
-StgDnDiff	20kPa	
-StgForRotation		▶
OperationRange		▶



OperationRange	1/12	
PipingGroup01		
-MaxPumpOnNum	2	← a.
-MinPumpOnNum	1	← b.
PipingGroup02		
-MaxPumpOnNum	2	

-MinPumpOnNum	2
PipingGroup03	
-MaxPumpOnNum	3
-MinPumpOnNum	0
PipingGroup04	
-MaxPumpOnNum	4
-MinPumpOnNum	4



Table 30 List of parameters which can be set from “OperationRange” screen

ID	Name	Definition
a.	MaxPumpOnNum	Maximum number of operating pumps for each piping group setting
b.	MinPumpOnNum	Minimum number of operating pumps for each piping group setting

NOTE: Please set this value “a” bigger than “b”.

9.3. Bypass Valve Control Setting

(Used screen: MainMenu > Setting > DeviceCtrlParam > BypassValve Ctrl)

- From “DeviceCtrlParam” screen, turn the click-dial  to select “BypassValve” menu then press down on the click-dial  to jump to “BypassValve Ctrl” screen.

	DeviceCtrlParam	3/5
	Chiller	▶
	PrimaryPump	▶
	BypassValve	▶
	CondenserPump	▶

- “Bypass Ctrl” screen is displayed. Here, various options for bypass valve control can be set.

	BypassValve Ctrl	1/4
	MaxCapacity	100%
	MinCapacity	0%
	PI_Param	
	-DiffPress	▶

← a.

← b.

← 9.3.1 Setting PI Parameters for Bypass Valve Control

Table 31 List of parameters which can be set from “BypassValve Ctrl” screen

ID	Name		Definition
a.	MaxCapacity	0...100 %	Maximum output value for PI control
b.	MinCapacity	0...100 %	Minimum output value for PI control

9.3.1. Setting PI Parameters for Bypass Valve Control

- From “MainMenu > Setting > DeviceCtrlParam > BypassValve Ctrl” screen, follow below steps to reach “ByValveDiffPress PI-Pa” screen. Here, PI parameter for bypass valve control can be set.

BypassValve Ctrl		4/4
MaxCapacity		100%
MinCapacity		0%
PI_Param		
DiffPress		▶

↓



ByValveDiffPress PI_Pa		1/5
DiffPress		
-Setpt	13kPa	← a.
-ActiveValue	13kPa	← b.
-PropBand	50kPa	← c.
-IntegralTime	60.0s	← d.

Table 32 List of parameters which can be set from “ByValveDiffPress PI_Pa” screen

ID	Name		Definition
a.	-Setpt	1...999 kPa	Target setpoint for bypass valve control
b.	-ActiveValue		Status display of actual setpoint (for future optimization control)
c.	-PropBand	0...999 kPa	Proportional band setting of PI control
d.	-IntegralTime	0.0...999.0 sec	Integral time setting of PI control

9.4. Condenser Pump Control Setting

(Used screen: MainMenu > Setting > DeviceCtrlParam > CondenserPump Ctrl)

- From “DeviceCtrlParam” screen, turn the click-dial  to select “CondenserPump” menu then press down on the click-dial  to jump to “CondenserPump Ctrl” screen.

DeviceCtrlParam		4/5
PrimaryPump		▶
BypassValve		▶
CondenserPump		▶
CTBypassValve		▶

- “CondenserPump Ctrl” screen is displayed. Here, various options for condenser pump control can be set.

CondenserPump Ctrl		1/4
CndPipingGroup1		▶
CndPipingGroup2		▶
CndPipingGroup3		▶
CndPipingGroup4		▶

3. For each “CondenserPump Ctrl”, press down on the click-dial  to jump to “CndPump Ctrl” screen, which is shown below. (Example shown is CndPipingGroup1)

Gr1 CndPump Ctrl	1/21	
PumpType	VFD	← a.
CtrlType	DiffTemp	← b.
SetptDiffTemp	5.0° C	← c.
-ActiveValue	5.0° C	← d.
SetptDiffPress	13kPa	← e.
-ActiveValue	13kPa	← f.
VFD Control		
-MaxCapacity	100%	← g.
-MinCapacity	0%	← h.
-DT_PI_Param	▶	← 9.4.1 Setting DT_PI Parameters for Pump VFD Control
-DP_PI_Param	▶	← 9.4.2 Setting DP_PI Parameters for Pump VFD Control
Staging		
-StgUpWaitTime	60s	← i.
-StgDnWatTme	60s	← j.
-StgUpDiffTemp	1.0° C	← k.
-StgDnDiffTemp	1.0° C	← l.
-StgUpDiffPress	5kPa	← m.
-StgDnDiffPress	5kPa	← n.
-StgForRotation	Enable	← o.
-WaitTime	24h	← p.
-OperarionRange	▶	← 9.4.3 Setting minimum / maximum number of operating pumps for each piping group

Table 33 List of parameters which can be set from “CndPump Ctrl” screen

ID	Name		Definition
a.	PumpType	VDF CSD	Set to VFD when VFD control of pumps is needed Set to CSD if constant flow is needed
b.	CtrlType	1...999 kPa	Select from temperature differential or pressure differential
c.	SetptDiffTemp	0.0...99.0 D°C	Target setpoint of temperature differential for VFD / CSD pump control
d.	-ActiveValue		Status display of actual setpoint (for future optimization control)
e.	SetptDiffPress	0...999 kPa	Target setpoint of pressure differential for VFD / CSD pump control
f.	-ActiveValue		Status display of actual setpoint (for future optimization control)
g.	-MaxCapacity	0...100 %	Maximum output for VFD control
h.	-MinCapacity	0...100 %	Minimum output for VFD control
i.	-StgUpWaitTime	1...600 sec	Wait time BEFORE stage up is confirmed
j.	-StgDnWatTme	1...600 sec	Wait time BEFORE stage down is confirmed

k.	-StgUpDiffTemp	0.0...99.0 dK	Temperature differential for deciding threshold of CSD pump staging up
l.	-StgDnDiffTemp	0.0...99.0 dK	Temperature differential for deciding threshold of CSD pump staging down
m.	-StgUpDiffPress	0...100 kPa	Pressure differential for deciding threshold of CSD pump staging up
n.	-StgDnDiffPress	0...100kPa	Pressure differential for deciding threshold of CSD pump staging down
o.	-StgForRotation		Enable/disable staging for rotation
p.	-WaitTime	24...720 h	Wait time BEFORE staging is confirmed

9.4.1. Setting DT_PI Parameters for Pump VFD Control

- From “MainMenu > Setting > DeviceCtrlParam > CondenserPump Ctrl” screen, follow below steps to reach “Gr# CndPpDT_PI_Param” screen. Here, PI parameter for pump VFD control can be set. (Gr1 is shown as an example.)

	Gr1 CndPump Ctrl	10/21	
	VFD_Control		
	-MaxCapacity	100%	
	-MinCapacity	0%	
	DT_PI_Param		▶

↓

	Gr1 CndPpDT PI Param	1/2	
	PropBand	10.0° C	← a.
	IntegralTime	20.0s	← b.

Table 34 List of parameters which can be set from “PrimaryPump Ctrl” screen

ID	Name	Definition
a.	PropBand	Proportional band setting of PI control
b.	IntegralTime	Integral time setting of PI control

9.4.2. Setting DP_PI Parameters for Pump VFD Control

- From “MainMenu > Setting > DeviceCtrlParam > CondenserPump Ctrl” screen, follow below steps to reach “Gr# CndPpDP_PI_Param” screen. Here, PI parameter for pump VFD control can be set. (Gr1 is shown as an example.)

	Gr1 CndPump Ctrl	11/21	
	-MaxCapacity	100%	
	-MinCapacity	0%	
	-DT_PI_Param		▶
	DP_PI_Param		▶

↓

	Gr1 CndPpDP PI Param	1/2	
	PropBand	10kPa	← a.
	IntegralTime	20.0s	← b.

Table 35 List of parameters which can be set from “PrimaryPump Ctrl” screen

ID	Name	Definition
a.	PropBand	Proportional band setting of PI control
b.	IntegralTime	Integral time setting of PI control

9.4.3. Setting minimum / maximum number of operating pumps for each piping group

- From “MainMenu > Setting > DeviceCtrlParam > CondenserPump Ctrl” screen, follow below steps to reach “OperationRange” screen. Here, minimum / maximum number of operating pumps for each piping group can be set.

	PrimaryPump Ctrl	21/21	
	-StgDnDffPress	5kPa	
	-StgForRotation	Enable	
	-WaitTime	24h	
	-OperationRange		▶



	Gr1 OperationRange	1/2	
	MaxPumpOnNum	2	← a.
	MinPumpOnNum	1	← b.



Table 36 List of parameters which can be set from “OperationRange” screen

ID	Name	Definition
a.	MaxPumpOnNum	Minimum number of operating pumps for each piping group setting
b.	MinPumpOnNum	Maximum number of operating pumps for each piping group setting

NOTE: Please DO NOT set value “b” bigger than “a”.

9.5. Cooling Tower Bypass Valve Control Setting



(Used screen: MainMenu > Setting > DeviceCtrlParam > CTBypasValve Ctrl)

- From “DeviceCtrlParam” screen, turn the click-dial  to select “CTBypassValve” menu then press down on the click-dial  to jump to “CTBypassValve Ctrl” screen.

	DeviceCtrlParam	5/5
	PrimaryPump	▶
	BypassValve	▶
	CondenserPump	▶
	CTBypassValve	▶

- “CTBypass Ctrl” screen is displayed. Here, various options for bypass valve control can be set.

	CTBypassValve Ctrl	1/4
	CndPipingGroup1	▶
	CndPipingGroup2	▶
	CndPipingGroup3	▶
	CndPipingGroup4	▶

- Turn the click-dial  to select “Gr# CTBypassValve Ctrl” menu for each condenser piping group number, then then press down on the click-dial  to jump to the” screen. (Gr1 is shown as an example)

	Gr1 CTBypassValve Ctrl	1/4	
	MaxCapacity	100%	← a.
	MinCapacity	0%	← b.
	PI Param		
	-CndWtEntTemp	▶	← 0

Setting PI Parameters for Cooling Tower Bypass Valve Control

Table 37 List of parameters which can be set from “CTBypassValve Ctrl” screen

ID	Name	Definition
a.	MaxCapacity	Maximum output value for PI control
b.	MinCapacity	Minimum output value for PI control

9.5.1. Setting PI Parameters for Cooling Tower Bypass Valve Control

- From “MainMenu > Setting > DeviceCtrlParam > CTBypassValve Ctrl>Gr# CTBypassValve Ctrl” screen, follow below steps to reach “CTBypValveDiffPress PI-Pa” screen. Here, PI parameter for bypass valve control can be set.

	Gr1 CTBypassValve Ctrl	4/4	
	MaxCapacity	100%	
	MinCapacity	0%	
	PI Param		
	CndWtEntTemp		▶

↓

	Gr1 CTBypValve_PI_Param	1/5	
	CndWtEntTemp		
	-Setpt	13kPa	← a.
	-ActiveValue	13kPa	← b.
	-PropBand	50kPa	← c.
	-IntegralTime	60.0s	← d.

Table 38 List of parameters which can be set from “CTBypValveDiffPress PI_Pa” screen

ID	Name	Definition
a.	-Setpt	Target setpoint for bypass valve control
b.	-ActiveValue	Status display of actual setpoint (for future optimization control)
c.	-PropBand	Proportional band setting of PI control
d.	-IntegralTime	Integral time setting of PI control



9.6. System Control Setting

Setting of various control parameters for system control can be done from this menu. Menu structure and items which can be set are described below.



<ul style="list-style-type: none"> □ MainMenu <ul style="list-style-type: none"> ○ Setting <ul style="list-style-type: none"> ▪ SystemCtrlParam
<ul style="list-style-type: none"> □ SystemCtrlParam <ul style="list-style-type: none"> ○ PowerFailureRecov.....Set parameters for power failure recovery control ○ DbITempSetpt.....Set parameters for double setpoint control ○ ProtectSystemSet pump frequency when recycling, pump frequency for force pump on, chiller on delay time, pump off delay time etc. ○ PullDownRateCtrl.....Set parameters for pull down rate control ○ SetptReset.....Set parameters for setpoint reset

1. Press the Home Button  to show the “MainMenu” screen.

MainMenu	1/4
Status	▶
Setting	▶
ConfigMode	▶
Password	▶

2. On the “MainMenu” screen, turn the click-dial  to select “Setting” menu then press down on the click-dial  to jump to “Setting” screen.

MainMenu	2/4
Status	▶
Setting	▶
ConfigMode	▶
Password	▶

3. On the “Setting” screen, turn the click-dial  to select “SystemCtrlParam” menu then press down on the click-dial  to jump to “SystemCtrlParam” screen.



Setting	1/5
SystemCtrlParam	▶
DeviceCtrlParam	▶
CtrlModeSetting	▶
SystemSetting	▶

4. SystemCtrlParam screen is shown. From this screen, you can jump to control parameter setting for different system control.

	SystemCtrlParam	1/6	
	PowerFailureRecov		← 9.6.1 Power Failure Recovery
	ProtectSystem		← 9.6.2 Protect System
	DbITempSetpt		← 9.6.3 Double Temperature Setpoint
	PullDownRatectrl		← 9.6.4 Pull Down Rate Control
	SetptReset		← 9.6.5 Setpoint reset

9.6.1. Power Failure Recovery

(Used screen: MainMenu > Setting > SystemCtrlParam > PowerFailureRecov)

1. From “SystemCtrlParam” screen, turn the click-dial  to select “PowerFailureRecov” menu then press down on the click-dial  to jump to “PowerFailureRecov” screen.

	SystemCtrlParam	1/6
	PowerFailureRecov	
	ProtectSystem	
	DbITempSetpt	
	PullDownRateCtrl	

2. “PowerFailureRecov” screen is shown. Here, parameters for power failure recovery control can be set.



	PowerFailureRecov	1/2	
	DetectionTime	5min	← a.
	RecovOption	Stop	← b.

Table 39 List of parameters which can be set from “PowerFailureRecov” screen

ID	Name	Definition
a.	DetectionTime	Power off duration to judge power failure (if power off time is less than this setting, it is considered power failure)
b.	RecovOption	Behaviour of iCM when recovering from power failure. (Always recover from stop / restore sysmte ON/OFF status before power off)

9.6.2. Protect System

(Used screen: MainMenu > Setting > SystemCtrlParam > ProtectSystem)

- From “SystemCtrlParam” screen, turn the click-dial  to select “ProtectSystem” menu then press down on the click-dial  to jump to “ProtectSystem” screen.

SystemCtrlParam		2/6
PowerFailureRecov		▶
ProtectSystem		▶
DbITempSetpt		▶
PullDownRateCtrl		▶

- “ProtectSystem” screen is shown. Here, parameters for system protection control can be set.

ProtectSystem		1/18
KeepMinEvaFlwCap	20%	← a.
ForcePriPpModeCap	40%	← b.
ChillerOnDelayTime	60s	← c.
ChillerOffDelayTime	180s	← d.
PumpOnDelayTime	60s	← e.
PumpOffDelayTime	60s	← f.
ValveOpenDelayTime	180s	← g.
RecycleDelayTime	360s	← h.
KeepMinCndFlowCap	20%	← i.
ForceCndPpModeCap	40%	← j.
CndPumpOnDelayTime	60s	← k.
CndPumpOffDelayTime	60s	← l.
CndValveOpenDelayTim e	60s	← m.
CndValveCloseDelayTim e	180s	← n.
CTValveOpenDelayTime	60s	← o.
CTValveCloseDelayTime	180s	← p.
CTFanOnDelayTime	60s	← q.
CTFanOffDelayTime	180s	← r.

Table 40 List of parameters which can be set from “ProtectSystem” screen

ID	Name	Definition
a.	KeepMinEvaFlwCap	Minimum VFD frequency for primary pump control to ensure minimum flow
b.	ForcePriPpModeCap	VFD frequency when using force pump on control
c.	ChillerOnDelayTime	Delay time after chiller ON Status to operate auxiliaries
d.	ChillerOffDelayTime	Delay time after chiller OFF Status to stop auxiliaries
e.	PumpOnDelayTime	Delay time after pump ON Status to operate auxiliaries
f.	PumpOffDelayTime	Delay time after pump OFF Status to stop auxiliaries
g.	ValveOpenDelayTime	Delay time after valve OPEN Status to operate chillers
h.	RecycleDelayTime	Delay time to operate auxiliaries after last chiller stops
i.	KeepMinCndFlowCap	Minimum condenser flow capacity
j.	ForceCndPpModeCap	Capacity when forced condenser pump mode is on
k.	CndPumpOnDelayTime	Delay time to operate auxiliaries after condenser pump runs
l.	CndPumpOffDelayTime	Delay time to operate auxiliaries after condenser pump stops
m.	CndValveOpenDelayTime	Delay time to operate auxiliaries after condenser valve operates
n.	CndValveCloseDelayTime	Delay time to operate auxiliaries after condenser valve stops
o.	CTValveOpenDelayTime	Delay time to operate auxiliaries after condenser pump operates
p.	CTValveCloseDelayTime	Delay time to operate auxiliaries after condenser pump stops
q.	CTFanOnDelayTime	Delay time to operate auxiliaries after cooling tower fan operates
r.	CTFanOffDelayTime	Delay time to operate auxiliaries after cooling tower fan stops



9.6.3. Double Temperature Setpoint

(Used screen: MainMenu > Setting > SystemCtrlParam > DbITempSetpt)

NOTE: Source of input setting for chilled water temperature setpoint needs to be “Control” for double temperature setpoint to work correctly. This is described in detail on Table 41.

Table 41 Setting vs. chilled water temperature output of double setpoint control

Setting			Chilled water temperature output
Source of input	Enable / Disable	External Signal	
Control	Enable	ON	Double Setpoint setting
		OFF	Chilled water temperature setpoint from HMI
Other	Disable	Don't care	Value from configured source of setting
		Don't care	

- From “SystemCtrlParam” screen, turn the click-dial  to select “DbITempSetpt” menu then press down on the click-dial  to jump to “DbITempSetpt” screen.

PowerFailureRecov	▶
ProtectSystem	▶
DbITempSetpt	▶
PullDownRateCtrl	▶

2. “DbITempSetpt” screen is shown. Here, parameters for double setpoint control can be set.

DbITempSetpt	1/2	
DbISptEnable	Disable	← a.
DbITempSetpt	5.0° C	← b.

Table 42 List of parameters which can be set from “ProtectSystem” screen

ID	Name	Definition
a.	DbISptEnable	Enable / disable double setpoint control. When enabled, actual setpoint will become value specified by double setpoint when receiving I/O signal. Note: when double setpoint is enabled but not external signal from I/O, chilled water temperature set from HMI will be used.
b.	DbITempSetpt	Set value of double setpoint

9.6.4. Pull Down Rate Control

(Used screen: MainMenu > Setting > SystemCtrlParam > PullDownRateCtrl)

Image of pull down rate control is shown on Figure 13

Stage up is inhibited when pull down rate exceeds Threshold 1 setting. Staging is allowed again when pull down rate becomes lower than Threshold 2 setting. Pull down rate is calculated every so often specified by measure band setting.

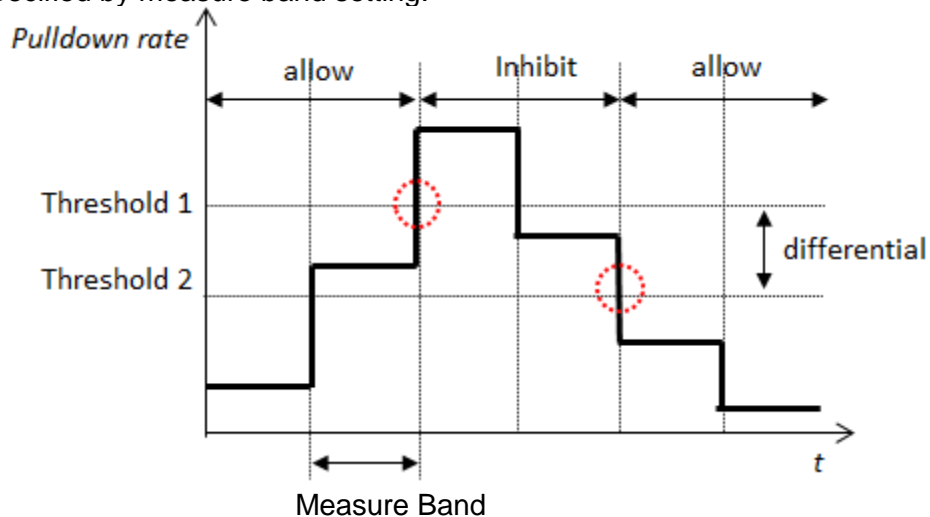



Figure 13 Pull Down Rate Control

- From “SystemCtrlParam” screen, turn the click-dial  to select “PullDownRateCtrl” menu then press down on the click-dial  to jump to “PullDownRateCtrl” screen.

	SystemCtrlParam	4/6
	PowerFailureRecov	▶
	ProtectSystem	▶
	DbtTempSetpt	▶
	PullDownRateCtrl	▶

- “PullDownRateCtrl” screen is shown. Here, parameters for pull down rate control can be set.



	PullDownRateCtrl	1/5	
	PIDnRateEnable	Disable	← a.
	TargetWtTemp	EWT	← b.
	MeasureBand	60s	← c.
	PIDnRateUpLimit	0.5 ° C / min	← d.
	PIDnRateOffset	0.1 ° C / min	← e.

Table 43 List of parameters which can be set from “PullDownRateCtrl” screen

ID	Name	Definition
a.	PIDnRateEnable	Enable / Disable pull down rate control
b.	TargetWtTemp	Use entering water temperature or leaving water temperature to calculated pull down rate
c.	MeasureBand	Window time duration to calculate pull down rate
d.	PIDnRateUpLimit	Upper limit of pull down rate before inhibiting stage up
e.	PIDnRateOffset	Differential value subtracted from upper limit when judging unlock of stage up

9.6.5. Setpoint reset

(Used screen: MainMenu > Setting > SystemCtrlParam > Setpt Reset)

- From “SystemCtrlParam” screen, turn the click-dial  to select “Setpt Reset” menu then press down on the click-dial  to jump to “PullDownRateCtrl” screen.

	SystemCtrlParam	5/6
	DbtTempSetpt	▶
	PullDownRatectrl	▶
	SetptReset	▶

- “Setpt Reset” screen is shown. Here, parameters for setpoint reset can be set.

	SetptReset	1/5	
	ResetEnable	Enable	← a.
	TargetTemp	OAT	← b.
	SetptDiff	5.0° C	← c.
	MaxReset	15.0° C	← d.

NoReset	25.0° C	← e.
---------	---------	------

Table 44 List of parameters which can be set from “Setpt Reset” screen

ID	Name	Definition
a.	ResetEnable	Enable / Disable setpoint reset
b.	Target Temp	Use outdoor air temperature or cooled water return temperature to calculate setpoint reset
c.	SetptDiff	Temperature differential when executing setpoint reset
d.	MaxReset	Maximum temperature to enable setpoint reset
e.	NoReset	Temperature setpoint to disable setpoint reset

9.7. Source of Input Setting



It is possible to specify, for each setpoint / command, which input to be effective. Setting of which source of input to be active for each item can be done from this menu. Menu structure and items which can be set are described below.

<ul style="list-style-type: none"> ❑ MainMenu <ul style="list-style-type: none"> ○ Setting <ul style="list-style-type: none"> ▪ CtrlModeSetting 	
<hr/>	
<ul style="list-style-type: none"> ❑ CtrlModeSetting <ul style="list-style-type: none"> ○ Run/Stop.....Set source of input for Run/Stop command ○ TempSetptSet source of input for chilled water temperature ○ ForcePriPumpModeSet source of input for force primary pump on command ○ ForceCondPumpMode.....Set source of input for force condenser pump on command ○ PriPpDiffPressSetptSet source of input for primary pump VFD differential pressure setpoint ○ Gr# CndPpCtrlSetpt.....Set source of input for condenser pump piping group control <ul style="list-style-type: none"> setpoint for each group (1 to 4) ○ BpVlvDiffPressSetpt.....Set source of input for bypass valve differential pressure <ul style="list-style-type: none"> Setpoint ○ Gr# CndBpVlvTempSetpt....Set source of input for condenser bypass valve temperature <ul style="list-style-type: none"> setpoint for condenser piping group (1 to 4) 	

Steps for selecting source of input are described below

1. Press the Home Button  to show the “MainMenu” screen.

MainMenu	1/4
Status	▶
Setting	▶
ConfigMode	▶
Password	▶

2. On the “MainMenu” screen, turn the click-dial  to select “Setting” menu then press down on the click-dial  to jump to “Setting” screen.

MainMenu	2/4
Status	▶
Setting	▶
ConfigMode	▶
Password	▶

3. On the “Setting” screen, turn the click-dial  to select “CtrlModeSetting” then press down on the click-dial  to jump to “CtrlModeSetting” screen.

Setting	3/5
SystemCtrlParam	▶
DeviceCtrlParam	▶
CtrlModeSetting	▶
SystemSetting	▶

4. On the “CtrlModeSetting” screen, source of input for various commands can be changed. Please refer to Table 44 for available source of input for each command.

CtrlModeSetting	1/12
Run/Stop	Manual
TempSetpt	Manual
ForcePriPumpMode	Manual
ForceCondPumpMode	Manual
PriPpDiffPressSetpt	Manual
Gr1CndPpCtrlSetpt	Manual
Gr2CndPpCtrlSetpt	Manual
Gr3CndPpCtrlSetpt	Manual
Gr4CndPpCtrlSetpt	Manual
BpVlvDiffPressSetpt	Manual
Gr1CndBpVlvTempSetpt	Manual
Gr2CndBpVlvTempSetpt	Manual
Gr3CndBpVlvTempSetpt	Manual
Gr4CndBpVlvTempSetpt	Manual

— Name of command

Manual: Manual Input from HMI is valid
I/O: Input from I/O is valid
Control: Input from internal control such as double setpoint is valid,
BACnet: Input from BACnet is valid
AutoCloud: Input from cloud is valid (for future use)

Table 45 illustrates available source of input for each command.

Table 45 List of Available Source of Input for Each Command

Name	Description	Manual	Auto			
			I/O	Control	BACnet	AutoCloud
Run/Stop	Run/Stop command	Y	Y	N	Y	Y
TempSetpt	Chilled water temperature setpoint	Y	Y	Y	Y	Y
ForcePriPumpMode	Force primary pump on command	Y	Y	N	Y	Y
ForceCondPumpMode	Force condenser pump on command	Y	Y	N	Y	Y
PriPpDiffPressSetpt	Differential pressure setpoint for primary pump VFD control	Y	N	N	N	Y
CndPpCtrlSetpt	Condenser pump control setpoint	Y	N	N	N	Y
BpVlvDiffPressSetpt	Differential pressure setpoint for bypass valve control	Y	N	N	N	Y
CndBpVlvTempSetpt	Temperature setpoint for condenser side bypass valve	Y	N	N	N	Y

CAUTION: Please DO NOT set control mode to source of input shown as “N”: NOT available” (e.g. Setting Control as source of input for Run/Stop). Resulting output and iCM behaviour is not guaranteed.

10. Trial Run

Sending command manually to various equipment in order to check connection can be done from this menu.



Note: the system needs to be in “Config Mode” when using trial run menu.

Menu structure and items which can be set are described below.



<ul style="list-style-type: none"> □ MainMenu <ul style="list-style-type: none"> ○ ConfigMode <ul style="list-style-type: none"> ▪ Trialrun
<ul style="list-style-type: none"> □ TrialRun <ul style="list-style-type: none"> ○ ChillerSend temperature setpoint manually to chiller ○ I/O.....Check connection of each ext. module, check input of each input I/O port, and send manual signal from each output I/O port ○ BACnet_Module.....Check connection status of BACnet Module.

1. Press the Home Button  to show the “MainMenu” screen.

	MainMenu	1/4
Status		▶
Setting		▶
ConfigMode		▶
Password		▶

2. On the “MainMenu” screen, turn the click-dial  to select “ConfigMode” menu then press down on the click-dial  to jump to “ConfigMode” screen.

	MainMenu	3/4
Status		▶
Setting		▶
ConfigMode		▶
Password		▶

3. On the “ConfigMode” screen, turn the click-dial  to select “TrialRun” menu then press down on the click-dial  to jump to “TrialRun” screen.

	ConfigMode	5/8
TrialRun		▶
Backup/Restore		▶
DataManagement		▶
Reset		-

4. “TrialRun” screen is shown. From this screen, you can jump to trial run menu of different equipment.

	TrialRun	1/4	
Chiller		▶	← 10.1 Chiller Trial Run
I/O		▶	← 10.2 I/O Trial Run
BACnet_Module	NoError		← 10.3 BACnet Module Trial

NOTE: Trial Run operation works when the system is in “Config Mode”

10.1. Chiller Trial Run



(Used screen: MainMenu > ConfigMode > TrialRun > Chiller TrialRun)

1. “Chiller TrialRun” screen is shown. From this screen, you can send temperature setpoint command to individual chiller to ensure connection is establish.

Chiller TrialRun		1/16
#01	-TempSetptcmd	0.0° C
#02	-TempSetptcmd	0.0° C
#03	-TempSetptcmd	0.0° C
#04	-TempSetptcmd	0.0° C
#05	-TempSetptcmd	0.0° C
#06	-TempSetptcmd	0.0° C
#07	-TempSetptcmd	0.0° C
#08	-TempSetptcmd	0.0° C

10.2. I/O Trial Run

(Used screen: MainMenu > ConfigMode > TrialRun > I/O TrialRun)

1. From “MainMenu > ConfigMode > TrialRun” screen, turn the click-dial  to select “I/O” menu then press down on the click-dial  to jump to “I/O TrialRun” screen.

I/O TrialRun		1/36	
BaseController			
-CheckPorts		▶	← AChecking individual ports of base controller
ExtI/O#1	NoError		← a.
-CheckPorts		▶	← B Checking individual ports of extension I/O #1
ExtI/O#2	NoError		← b.
-CheckPorts		▶	← C Checking individual ports of extension I/O #2
ExtI/O#3	NoError		← c.
-CheckPorts		▶	← D Checking individual ports of extension I/O #3
ExtI/O#4	NoError		← d.
-CheckPorts		▶	← Checking individual ports of extension I/O #4
ExtI/O#5	NoError		← e.
-CheckPorts		▶	← F Checking individual ports of extension I/O #5
ExtI/O#6	NoError		← f.
-CheckPorts		▶	← G Checking individual ports of extension I/O #6

Extl/O#9	NoError	← i.
-CheckPorts	▶	← H Checking individual ports of extension I/O #9
Extl/O#10	NoError	← j.
-CheckPorts	▶	← I Checking individual ports of extension I/O #10
Extl/O#11	NoError	← k.
-CheckPorts	▶	← J Checking individual ports of extension I/O #11
Extl/O#12	NoError	← l.
-CheckPorts	▶	← K Checking individual ports of extension I/O #12
Extl/O#13	NoError	← m.
-CheckPorts	▶	← L Checking individual ports of extension I/O #13
Extl/O#14	NoError	← n.
-CheckPorts	▶	← M Checking individual ports of extension I/O #14
Extl/O#15	NoError	← o.
-CheckPorts	▶	← N Checking individual ports of extension I/O #15
Extl/O#16	NoError	← p.
-CheckPorts	▶	← O Checking individual ports of extension I/O #16

Table 46 List of parameters which can be set from “I/O TrialRun” screen

ID	Name	Definition
a.	Extl/O#1	Error is displayed if Extl/O#1 is registered but no connection found
b.	Extl/O#2	Error is displayed if Extl/O#2 is registered but no connection found
c.	Extl/O#3	Error is displayed if Extl/O#3 is registered but no connection found
d.	Extl/O#4	Error is displayed if Extl/O#4 is registered but no connection found
e.	Extl/O#5	Error is displayed if Extl/O#5 is registered but no connection found
f.	Extl/O#6	Error is displayed if Extl/O#6 is registered but no connection found
i.	Extl/O#9	Error is displayed if Extl/O#9 is registered but no connection found
j.	Extl/O#10	Error is displayed if Extl/O#10 is registered but no connection found
k.	Extl/O#11	Error is displayed if Extl/O#11 is registered but no connection found
l.	Extl/O#12	Error is displayed if Extl/O#12 is registered but no connection found
m.	Extl/O#13	Error is displayed if Extl/O#13 is registered but no connection found
n.	Extl/O#14	Error is displayed if Extl/O#14 is registered but no connection found
o.	Extl/O#15	Error is displayed if Extl/O#15 is registered but no connection found
p.	Extl/O#16	Error is displayed if Extl/O#16 is registered but no connection found

A. Checking individual ports of base controller

User screen: MainMenu > ConfigMode > TrialRun > I/O TrialRun > BaseController CheckPort

- From “BaseController Ports” screen you can perform point check against I/Os.

	BaseController Ports	1/12	
X1	Run/Stop	OFF	← a.

X2	TempSetpt	7.0° C	← b.
X3	EmgStop	ON	← c.
X4	OpenRateCmd	0%	← d.
X5	DblSpt	OFF	← e.
X6	ChWtLvTemp	-99.0° C	← f.
	-Alarm	DeviceError	← g.
X7	ChWtEntTemp	-99.0° C	← h.
	-Alarm	DeviceError	← i.
X8	DiffPress	0kPa	← j.
	-Alarm	DeviceError	← k.
DO1	SysRun/Stop	OFF	← l.
DO2	SysAlarm	OFF	← m.
DI1	ForcePriPumpMod e	ON	← n.
DI2	ForceCndPumpMo de	OFF	← o.

Table 47 List of parameters which can be set from “BaseController Ports” screen

ID	Name	Definition
a.	Run/Stop	Display status of DI signal
b.	TempSetpt	Display status of AI signal
c.	EmgStop	Display status of DI signal
d.	OpenRateCmd	Manually send AO signal
e.	DblSpt	Display status of DI signal
f.	ChWtLvTemp	Display status of AI signal
g.	-Alarm	Display alarm status
h.	ChWtEntTemp	Display status of AI signal
i.	-Alarm	Display alarm status
j.	DiffPress	Display status of AI signal
k.	-Alarm	Display alarm status
l.	SysRun/Stop	Manually send DO signal
m.	SysAlarm	Manually send DO signal
n.	ForcePriPumpMode	Display status of DI signal
o.	ForceCndPumpMode	Display status of DI signal

B. Checking individual ports of extension I/O #1

User screen: MainMenu > ConfigMode > TrialRun > I/O TrialRun > ExtI/O#01 CheckPort

- From “ExtI/O#01 Ports” screen, you can perform point check against I/Os.

	ExtI/O#01 Ports	1/8	
X1	PriPp1CapCmd	0%	← a.
X2	PriPp1Run/Stop	OFF	← b.
X3	PriPp1Alarm	OFF	← c.
X4	PriPp1CapCmd	0%	← d.
X5	PriPp1Run/Stop	OFF	← e.
X6	PriPp1Alarm	OFF	← f.

DO1	PriPp1ONOFF	OFF	← g.
DO2	PriPp2ONOFF	OFF	← h

Table 48 List of parameters which can be set from “Extl/O#01 Ports” screen

ID	Name	Definition
a.	PriPp1CapCmd	Manually send AO signal
b.	PriPp1Run/Stop	Display status of DI signal
c.	PriPp1Alarm	Display status of DI signal
d.	PriPp1CapCmd	Manually send AO signal
e.	PriPp1Run/Stop	Display status of DI signal
f.	PriPp1Alarm	Display status of DI signal
g.	PriPp1ONOFF	Manually send DO signal
h.	PriPp2ONOFF	Manually send DO signal

C. Checking individual ports of extension I/O #2

D. Checking individual ports of extension I/O #3

E. Checking individual ports of extension I/O #4

Please refer for these extension modules to B Checking individual ports of extension I/O #1

F. Checking individual ports of extension I/O #5

User screen: MainMenu > ConfigMode > TrialRun > I/O TrialRun > Extl/O#05 CheckPort

1. From “Extl/O#05 Ports” screen, you can perform point check against I/Os.

	Extl/O#05 Ports	1/12	
X1	EvSO_Vv1O/C	OFF	← a.
X2	EvSO_Vv2O/C	OFF	← b.
X3	EvSO_Vv3O/C	OFF	← c.
X4	EvSO_Vv4O/C	OFF	← d.
X5	EvSO_Vv1Alarm	OFF	← e.
X6	EvSO_Vv2Alarm	OFF	← f.
X7	EvSO_Vv3Alarm	OFF	← g.
X8	EvSO_Vv4Alarm	OFF	← h
DO1	EvSO_Vv1ONOFF	OFF	← i.
DO2	EvSO_Vv2ONOFF	OFF	← j
DO3	EvSO_Vv3ONOFF	OFF	← k.
DO4	EvSO_Vv4ONOFF	OFF	← l.

Table 49 List of parameters which can be set from “Extl/O#05 Ports” screen

ID	Name	Definition
a.	EvSO_Vv1O/C	Display status of DI signal
b.	EvSO_Vv2O/C	Display status of DI signal
c.	EvSO_Vv3O/C	Display status of DI signal
d.	EvSO_Vv4O/C	Display status of DI signal
e.	EvSO_Vv1Alarm	Display status of DI signal
f.	EvSO_Vv2Alarm	Display status of DI signal
g.	EvSO_Vv3Alarm	Display status of DI signal
h.	EvSO_Vv4Alarm	Display status of DI signal

i.	EvSO_Vv1ONOFF	Manually send DO signal
j.	EvSO_Vv2ONOFF	Manually send DO signal
k.	EvSO_Vv3ONOFF	Manually send DO signal
l.	EvSO_Vv4ONOFF	Manually send DO signal

G. Checking individual ports of extension I/O #6

Please refer for this extension module to F Checking individual ports of extension I/O #5

H. Checking individual ports of extension I/O #9

User screen: MainMenu > ConfigMode > TrialRun > I/O TrialRun > ExtI/O#09 CheckPort

- From “ExtI/O#09 Ports” screen, you can perform point check against I/Os.

ExtI/O#09 Ports		1/7	
X1	CndWtEntTemp1	25.0° C	← a.
	-Alarm	OFF	← b.
X2	CndWtEntTemp2	25.0° C	← c.
	-Alarm	OFF	← d.
X3	CndWtLvgTemp1	30.0° C	← e.
	-Alarm	OFF	← f.
X4	CndWtLvgTemp2	30.0° C	← g.
	-Alarm	OFF	← h.
X5	CndDiffPress1	332kPa	← i.
	-Alarm	OFF	← j.
X6	CndDiffPress2	332kPa	← k.
	-Alarm	OFF	← l.
X7	OutdoorTemp	28.0° C	← m.
	-Alarm	OFF	← n.

Table 50 List of parameters which can be set from “ExtI/O#09 Ports” screen

ID	Name	Definition
a.	CndWtEntTemp1	Manually send AO signal
b.	-Alarm	Display alarm status
c.	CndWtEntTemp2	Manually send AO signal
d.	-Alarm	Display alarm status
e.	CndWtLvgTemp1	Manually send AO signal
f.	-Alarm	Display alarm status
g.	CndWtLvgTemp2	Manually send AO signal
h.	-Alarm	Display alarm status
i.	CndDiffPress1	Manually send AO signal
j.	-Alarm	Display alarm status
k.	CndDiffPress2	Manually send AO signal
l.	-Alarm	Display alarm status
m.	OutdoorTemp	Display status of AI signal
n.	-Alarm	Display alarm status

I. Checking individual ports of extension I/O #10

Please refer for this extension module to H Checking individual ports of extension I/O #9

J. Checking individual ports of extension I/O #11

User screen: *MainMenu > ConfigMode > TrialRun > I/O TrialRun > ExtI/O#011 CheckPort*

- From “ExtI/O#11 Ports” screen, you can perform point check against I/Os.

	ExtI/O#11 Ports	1/10	
X1	CndPp1CapCmd	0%	← a.
X2	CndPp2CapCmd	0%	← b.
X3	BV1OpenRateCmd	0%	← c.
X4	BV2OpenRateCmd	0%	← d.
X5	CndPp1Run/Stop	OFF	← e.
X6	CndPp2Run/Stop	OFF	← f.
X7	CndPp1Alarm	OFF	← g.
X8	CndPp2Alarm	OFF	← h.
DO1	CndPp1ONOFF	OFF	← i.
DO2	CndPp2ONOFF	OFF	← j.

Table 51 List of parameters which can be set from “ExtI/O#11 Ports” screen

ID	Name	Definition
X1	CndPp1CapCmd	Manually send AO signal
X2	CndPp2CapCmd	Manually send AO signal
X3	BV1OpenRateCmd	Manually send AO signal
X4	BV2OpenRateCmd	Manually send AO signal
X5	CndPp1Run/Stop	Manually send DO signal
X6	CndPp2Run/Stop	Manually send DO signal
X7	CndPp1Alarm	Manually send DO signal
X8	CndPp2Alarm	Manually send DO signal
DO1	CndPp1ONOFF	Manually send DO signal
DO2	CndPp2ONOFF	Manually send DO signal

K. Checking individual ports of extension I/O #12

Please refer for this extension module to J Checking individual ports of extension I/O #11

L. Checking individual ports of extension I/O #13

User screen: *MainMenu > ConfigMode > TrialRun > I/O TrialRun > ExtI/O#013 CheckPort*

- From “ExtI/O#13 Ports” screen, you can perform point check against I/Os.

	ExtI/O#13 Ports	1/8	
X1	CndPp5CapCmd	0%	← a.
X2	CndPp6CapCmd	0%	← b.
X5	CndPp5Run/Stop	OFF	← c.
X6	CndPp6Run/Stop	OFF	← d.
X7	CndPp5Alarm	OFF	← e.

X8	CndPp6Alarm	OFF	← f.
DO1	CndPp5ONOFF	OFF	← g.
DO2	CndPp6ONOFF	OFF	← h.

Table 52 List of parameters which can be set from “Extl/O#13 Ports” screen

ID	Name	Definition
X1	CndPp5CapCmd	Manually send AO signal
X2	CndPp6CapCmd	Manually send AO signal
X5	CndPp5Run/Stop	Manually send DO signal
X6	CndPp6Run/Stop	Manually send DO signal
X7	CndPp5Alarm	Manually send DO signal
X8	CndPp6Alarm	Manually send DO signal
DO1	CndPp5ONOFF	Manually send DO signal
DO2	CndPp6ONOFF	Manually send DO signal

M. Checking individual ports of extension I/O #14

Please refer for this extension module to L Checking individual ports of extension I/O #13

N. Checking individual ports of extension I/O #15

User screen: MainMenu > ConfigMode > TrialRun > I/O TrialRun > Extl/O#015 CheckPort

- From “Extl/O#15 Ports” screen, you can perform point check against I/Os.

Extl/O#15 Ports		1/12	
X1	CndSO Vv1O/C	OFF	← a.
X2	CndSO Vv2O/C	OFF	← b.
X3	CndSO Vv3O/C	ON	← c.
X4	CndSO Vv4O/C	OFF	← d.
X5	CndSO Vv1Alarm	OFF	← e.
X6	CndSO Vv2Alarm	ON	← f.
X7	CndSO Vv3Alarm	OFF	← g.
X8	CndSO Vv4Alarm	OFF	← h.
DO1	CndSO Vv1ONOFF	OFF	← i.
DO2	CndSO Vv2ONOFF	ON	← j.
DO3	CndSO Vv3ONOFF	OFF	← k.
DO4	CndSO Vv4ONOFF	OFF	← l.

Table 53 List of parameters which can be set from “Extl/O#15 Ports” screen

ID	Name	Definition
X1	CndSO Vv1O/C	Manually send DO signal
X2	CndSO Vv2O/C	Manually send DO signal
X3	CndSO Vv3O/C	Manually send DO signal
X4	CndSO Vv4O/C	Manually send DO signal

X5	CndSO Vv1Alarm	Manually send DO signal
X6	CndSO Vv2Alarm	Manually send DO signal
X7	CndSO Vv3Alarm	Manually send DO signal
X8	CndSO Vv4Alarm	Manually send DO signal
DO1	CndSO Vv1ONOFF	Manually send DO signal
DO2	CndSO Vv2ONOFF	Manually send DO signal
DO3	CndSO Vv3ONOFF	Manually send DO signal
DO4	CndSO Vv4ONOFF	Manually send DO signal

O. Checking individual ports of extension I/O #16

Please refer for this extension module to N Checking individual ports of extension I/O #15

10.3. BACnet Module Trial Run

(Used screen: MainMenu > ConfigMode > TrialRun)

1. From “MainMenu > ConfigMode > TrialRun” screen you can check the error status of BACnet_Module.

	TrialRun	4/4
	Chiller	▶
	I/O	▶
	BACnet_Module	NoError

11. Saving / Loading Configuration Data



Configuration for iCM can be saved to / loaded from SD card.

Menu structure for saving / loading configuration data is described below.



<ul style="list-style-type: none"> □ MainMenu <ul style="list-style-type: none"> ○ ConfigMode <ul style="list-style-type: none"> ▪ Backup/Restore
<ul style="list-style-type: none"> □ Backup/Restore <ul style="list-style-type: none"> ○ Backup.....Save configuration data to SD card, check result ○ RestoreLoad configuration data from SD card, check result

1. Press the Home Button  to show the “MainMenu” screen.

MainMenu	1/4
Status	▶
Setting	▶
ConfigMode	▶
Password	▶

2. On the “MainMenu” screen, turn the click-dial  to select “ConfigMode” menu then press down on the click-dial  to jump to “ConfigMode” screen.

MainMenu	3/4
Status	▶
Setting	▶
ConfigMode	▶
Password	▶

3. On the “ConfigMode” screen, turn the click-dial  to select “Backup/Restore” menu then press down on the click-dial  to jump to “Backup/Restore” screen.

ConfigMode	6/8
TrialRun	▶
Backup/Restore	▶
DataManagement	▶
Result	▶

4. On the “Backup/Restore” screen, you can backup iCM setting to SD card or restore setting from SD card.

NOTE: Make sure SD card is inserted to main controller when performing backup / restore.

	Backup/Restore	1/4	
	Backup	-	← a.
	-Result	NG	← b.
	Restore	-	← c.
	-Result	NG	← d.

Table 54 List of parameters which can be set from “Backup/Restore” screen

ID	Name	Definition
a.	Backup	Backup setting to SD card
b.	-Result	OK is displayed if backup is successful
c.	Restore	Restore setting from SD card
d.	-Result	OK is displayed if restore is successful

NOTE: It could be necessary to restore and reboot the controller more than once in order to enable all the devices (first restore and reset) and set all parameters (second restore and reset) from saved configuration.



12. Monitoring

12.1. Showing Current Status of System

Steps for showing the current status of whole system are described below.

1. Press the Home Button  to show the “MainMenu” screen.

	MainMenu	1/4
Status		▶
Setting		▶
ConfigMode		▶
Password		▶

2. On the “MainMenu” screen, turn the click-dial  to select “Status” menu then press down on the click-dial  to jump to “Status” screen.

	MainMenu	1/4
Status		▶
Setting		▶
ConfigMode		▶
Password		▶

3. On the “Status” screen, statuses for whole system are displayed.

	Status	1/22	
Command		▶	← refer to 13 Operation
-Status	Standby		← a.
-Alarm	-		← b.
-FaultType	-----		← c.
-StageUp	Unlock		← d.
-OpMode	Cool		← e.
-ChWtLvlgTempAve	7.5° C		← g.
-TempSetpt	7.0° C		← h.
-SptSource	Manual		← i.
-ChWtEntTempAve	12.5° C		← j.
-SysLoad	34%		← k.
Chiller		▶	← refer to 12.2 Showing Current Status of Chillers
EvShutOffValve		▶	← refer to 12.3 Showing Current Status of Evaporator Side Shut Off Valve
CndShutOffValve		▶	← refer to 12.4 Showing Current Status of Condenser Side Shut Off Valve
PrimaryPump		▶	← refer to 12.5 Showing Current Status of Primary Pumps
BypassValve		▶	← refer to 12.6 Showing Current Status of Bypass Valve
CondenserPump		▶	← refer to 12.7 Showing Current Status of Condenser Pumps
CTBypassValve		▶	← refer to 12.8 Showing Current Status of Cooling Tower Bypass Valve
Sensor		▶	← refer to 12.9 Showing Current Status of Sensors

I/O	▶	← refer to 12.10 Showing Current Status of I/O
Control	▶	← refer to 12.11 Showing Current Status of Controls

Table 55 List of parameters which can be set from “Command” screen

ID	Name	Definition
a.	-Status	System status (Configuration, Standby, InitialLoading, Operation, E-stop)
b.	-Alarm	System alarm type(-, Fault)
c.	-FaultType	System alarm code (see 15.1 Alarm Codes for list of alarm codes)
d.	-StageUp	Status of stage up inhibit (lock / unlock)
e.	-OpMode	Operation mode (Cooling, heating)
g.	-ChWtLvqTempAve	Chilled water leaving temp
h.	-TempSetpt	Chilled water temperature setpoint
i.	-SptSource	Source of input setting for chilled water temperature setpoint
j.	-ChWtEntTempAve	Chilled water entering temp
k.	-SysLoad	Load of current loop

12.2. Showing Current Status of Chillers

Steps for showing the current status of chillers are described below
 There are 2 views for showing current status of chillers.

- Overview
- Detailed view

12.2.1. Showing the overview of chillers

(Used screen: MainMenu > Status > Chillers)



- On the “Chiller Status screen”, statuses of chillers are displayed.

Chiller Status					2/9
	R/S	Alm	Cap		
#01	R	Stop	20%	▶	
#02	M R	Stop	Comm	0%	▶
#03	L	Stop	Dev	20%	▶

Actual Capacity
 Alarm status (Comm: Communication error, Dev: Device error, Mon: Monitoring error)
 Run/Stop status (Run, Stop)
 Remote/Local (R: Remote, L: Local)
 Maintenance status (M: Maintenance, “-”: Normal)
 Unit number

12.2.2. Showing the detailed view of chillers

(Used screen: MainMenu > Status > Chillers > Detail)

- On the “MainMenu > Status > Chiller Status” screen, turn the click-dial  to select the chiller unit you would like to see the detailed view then press down on the click-dial  to jump to “ChillerXX detail” screen

Chiller Status					2/9
	R/S	Alm	Cap		
#01	R	Stop	20%		▶
#02	M R	Stop	Comm	0%	▶
#03	L	Stop	Dev	20%	▶

- On the “Chiller XX Detail” screen, detailed status of chiller can be monitored

Chiller XX Detail		1/14	
Run/Stop	Stop		← Run/Stop State (Run, Stop)
-Command	-		← Run/Stop Command (Run, Stop)
Alarm	CommError		← Alarm Status
-ErrorCode	--		← Alarm code of chiller (in hexadecimal)
-AlarmReset	-		← Alarm Reset Command (-, Reset)
Maintenance	-		← Maintenance setting (-, Maintenance)
-State	-		← Maintenance state (-, Maintenance)
-Reason	-		← Reason for maintenance state
ActualCapacity	50%		← Actual Capacity
Remote/Local	Remote		← Remote/Local state of chiller (Remote, Local)
ChWtEntTemp	7.0° C		← Chilled Water Entering Temperature
ChWtLvgTemp	12.0° C		← Chilled Water Leaving Temperature
ChWtLvgTempSetpt	7.0° C		← Chilled Water Setpoint
OpMode	Cooling		← Operation Mode (Cooling, Heating)

12.3. Showing Current Status of Evaporator Side Shut Off Valve



(Used screen: MainMenu > Status > EvShutOffValve)

1. On the “EvShutOffValve Status” screen, statuses of valves are displayed.

EvShutOffValve Status		2/9
O/C	Alm	
#01	Close	▶
#02 M	Close	▶ Dev
#03	Close	▶ Mon

Alarm status (Dev: Device error, Mon: Monitoring error)
 Open/Close status (Open, Close)
 Maintenance status (M: Maintenance, “-”: Normal)
 Unit number

12.3.1. Showing the detailed view of Evaporator Side Shut Off Valve

1. On the “MainMenu > Status > EvShutOffValve Status” screen, turn the click-dial  to select the valve unit you would like to see the detailed view then press down on the click-dial  to jump to “EvSO_ValveXX detail” screen

EvShutOffValve Status		2/9
O/C	Alm	
#01	Close	▶
#02 M	Close	▶ Dev
#03	Close	▶ Mon

2. On the “EvSO_Valve XX Detail” screen, detailed status of Evaporator Side Shut Off Valve can be monitored

EvSO_Valve XX Detail		XX/5
Open/Close	Close	← Open/Close State (Open/Close)
-Command	-	← Open/Close Command (Open/Close)
Alarm	CommError	← Alarm Status
Maintenance	-	← Maintenance setting (-, Maintenance)
-State	-	← Maintenance state (-, Maintenance)

12.4. Showing Current Status of Condenser Side Shut Off Valve



(Used screen: MainMenu > Status > CndShutOffValve)

1. On the “EvShutOffValve Status” screen, statuses of valves are displayed.

CndShutOffValve Status		2/9
	O/C	Alm
01	Close	▶
#02 M	Close	Dev ▶
#03	Close	Mon ▶

Alarm status (Dev: Device error, Mon: Monitoring error)
 Open/Close status (Open, Close)
 Maintenance status (M: Maintenance, “-”: Normal)
 Unit number

12.4.1. Showing the detailed view of Condenser Side Shut Off Valve

1. On the “MainMenu > Status > CndShutOffValve Status” screen, turn the click-dial  to select the valve unit you would like to see the detailed view then press down on the click-dial  to jump to “CndSO_ValveXX detail” screen

CndShutOffValve Status		2/9
	O/C	Alm
01	Close	▶
#02 M	Close	Dev ▶
#03	Close	Mon ▶

2. On the “CndSO_ValveXX Detail” screen, detailed status of Condenser Side Shut Off Valve can be monitored

CndSO_ValveXX Detail		XX/5
Open/Close	Close	← Open/Close State (Open/Close)
-Command	-	← Open/Close Command (Open/Close)
Alarm	CommError	← Alarm Status
Maintenance	-	← Maintenance setting (-, Maintenance)
-State	-	← Maintenance state (-, Maintenance)

12.5. Showing Current Status of Primary Pumps



(Used screen: MainMenu > Status > PrimaryPump)

1. On the “PrimaryPump Status” screen, statuses of pumps are displayed.

PrimaryPump Status				2/9
	R/S	Alm	Cap	
#01	Stop		20%	▶
#02 M	Stop	Comm	0%	▶
#03	Stop	Dev	20%	▶

— VFD frequency
 — Alarm status (Comm: communication error, Dev: Device error, Mon: Monitoring error)
 — Run/Stop status (Run, Stop)
 — Maintenance status (M: Maintenance, “-”: Normal)
 — Unit number

12.5.1. Showing the detailed view of Primary Pumps

1. On the “MainMenu > Status > PrimaryPump Status” screen, turn the click-dial  to select the primary pump unit you would like to see the detailed view then press down on the click-dial  to jump to “PrimaryPumpXX detail” screen

PrimaryPump Status				2/9
	R/S	Alm	Cap	
#01	Stop		20%	▶
#02 M	Stop	Comm	0%	▶
#03	Stop	Dev	20%	▶

2. On the “PrimaryPumpXX Detail” screen, detailed status of pump can be monitored

PrimaryPumpXX Detail		1/6
Run/Stop	Stop	← Run/Stop State (Run, Stop)
-Command	-	← Run/Stop Command (Run, Stop)
Alarm	CommError	← Alarm Status
Maintenance	-	← Maintenance setting (-, Maintenance)
-State	-	← Maintenance state (-, Maintenance)
ActualCapacity	50%	← Actual Capacity

12.6. Showing Current Status of Bypass Valve

(Used screen: MainMenu > Status > Bypass Valve)

1. On the “BypassValve Status” screen, statuses of bypass valve is displayed.

BypassValve Status		1/1
ActualOpenRate		20%

12.7. Showing Current Status of Condenser Pumps



(Used screen: MainMenu > Status > CondenserPump)

1. On the “CondenserPump Status” screen, statuses of pumps are displayed.

CondenserPump Status				2/9
	R/S	Alm	Cap	
#01	Stop		20%	▶
#02 M	Stop	Comm	0%	▶
#03	Stop	Dev	20%	▶

— VFD frequency
 — Alarm status (Comm: communication error, Dev: Device error, Mon: Monitoring error)
 — Run/Stop status (Run, Stop)
 — Maintenance status (M: Maintenance, “-”: Normal)
 — Unit number

12.7.1. Showing the detailed view of Condenser Pumps

1. On the “MainMenu > Status > CondenserPump Status” screen, turn the click-dial  to select the condenser pump unit you would like to see the detailed view then press down on the click-dial  to jump to “CondenserPumpXX detail” screen

CondenserPump Status				2/9
	R/S	Alm	Cap	
#01	Stop		20%	▶
#02 M	Stop	Comm	0%	▶
#03	Stop	Dev	20%	▶

2. On the “CondenserPump XX Detail” screen, detailed status of pump can be monitored

CondenserPump XX Detail		1/6	
Run/Stop	Stop		← Run/Stop State (Run, Stop)
-Command	-		← Run/Stop Command (Run, Stop)

Alarm	CommError	← Alarm Status
Maintenance	-	← Maintenance setting (-, Maintenance)
-State	-	← Maintenance state (-, Maintenance)
ActualCapacity	50%	← Actual Capacity

12.8. Showing Current Status of Cooling Tower Bypass Valve

(Used screen: MainMenu > Status > CTBypassValve)

1. On the “CTBypassValve Status” screen, statuses of cooling tower bypass valve are displayed.

	CTBypassValve Status	1/1
#01	ActualOpenRate	20%
#02	ActualOpenRate	20%
#03	ActualOpenRate	20%
#04	ActualOpenRate	20%

12.9. Showing Current Status of Sensors

(Used screen: MainMenu > Status > Sensors)

1. On the “Sensors Status” screen, statuses of sensors are displayed. Displayed sensors differ depending on the system setup.

	Sensors Status	1/32	
	DiffPress	50kPa	← Differential Pressure
	-Alarm	-	← Alarm status for the sensor
	ChWtLvgTemp	6.6° C	← Supply Water Temperature
	-Alarm	-	← Alarm status for the sensor
	ChWtEntTemp	11.7° C	← Return Water Temperature
	-Alarm	-	← Alarm status for the sensor
	CndWtEntTemp1	-° C	← Condenser Entering Water Temp. #1
	-Alarm	-	← Alarm status for the sensor
	CndWtLvgTemp1	-° C	← Condenser Leaving Water Temp. #1
	-Alarm	-	← Alarm status for the sensor
	CndDiffPress1	-kPa	← Condenser Differential Pressure #1
	-Alarm	-	← Alarm status for the sensor
	CndWtEntTemp2	-° C	← Condenser Entering Water Temp. #2
	-Alarm	-	← Alarm status for the sensor
	CndWtLvgTemp2	-° C	← Condenser Leaving Water Temp. #2
	-Alarm	-	← Alarm status for the sensor
	CndDiffPress2	-kPa	← Condenser Differential Pressure #2
	-Alarm	-	← Alarm status for the sensor
	CndWtEntTemp3	-° C	← Condenser Entering Water Temp. #3
	-Alarm	-	← Alarm status for the sensor
	CndWtLvgTemp3	-° C	← Condenser Leaving Water Temp. #3
	-Alarm	-	← Alarm status for the sensor
	CndDiffPress3	-kPa	← Condenser Differential Pressure #3
	-Alarm	-	← Alarm status for the sensor

CndWtEntTemp4	-° C	← Condenser Entering Water Temp. #4
-Alarm	-	← Alarm status for the sensor
CndWtLvgTemp4	-° C	← Condenser Leaving Water Temp. #4
-Alarm	-	← Alarm status for the sensor
CndDiffPress4	-kPa	← Condenser Differential Pressure #4
-Alarm	-	← Alarm status for the sensor
OutdoorTemp	-° C	← Outdoor Temperature
-Alarm	-	← Alarm status for the sensor

12.10. Showing Current Status of I/O

(Used screen: MainMenu > Status > I/O)

1. On the “I/O Status” screen, status of I/Os are displayed.

I/O Status	1/1
DbiSpt	OFF



12.11. Showing Current Status of Controls

(Used screen: MainMenu > Status > Control)

1. On the “Control Status” screen, status of controls is displayed.

Control Status	1/2	
Chiller	▶	← 12.11.1 Show current status of chiller control
PrimaryPump	▶	← 12.11.2 Show current status of primary pump control

12.11.1. Show current status of chiller control



- From the “MainMenu>Status>Control Status” screen, turn the click-dial  to select “Chiller” menu then press down on the click-dial  to jump to “Chiller Control Status” screen.

Control Status		1/2
Chiller		▶
PrimaryPump		▶

- On the “Chiller Control Status” screen, status of chiller controls is displayed.

ChillerCtrl Status		1/9	
StageUp			
-StgByLoadLimit	100s	←	Timer count value for staging up for Load Condition
-StgUpDiff	100s	←	Timer count value for staging up for Supply temperaure condition
-StgByTargetLoad	100s	←	Timer count value for staging up for Target load condition
-StgForRotation	100s	←	Timer count value for staging up for time without staging conditions
StageDown			
-StgByLoadLimit	100s	←	Timer count value for staging down
-StgDnDiff	100s	←	Timer count value for staging down
-PonyChCtrl	100s	←	Timer count value for staging down

12.11.2. Show current status of primary pump control

- From the “MainMenu>Status>Control Status” screen, turn the click-dial  to select “PrimaryPump” menu then press down on the click-dial  to jump to “PrimaryPump Control Status” screen.

Control Status		2/2
Chiller		▶
PrimaryPump		▶

- On the “PrimaryPump Control Status” screen, status of primary pump controls is displayed.

PriPpCtrl Status		1/9	
StageUp	100s	←	Timer count value for staging up
StageDown	100s	←	Timer count value for staging down

13. Operation



Menu structure of related screens is displayed below.

<ul style="list-style-type: none"> ❑ MainMenu <ul style="list-style-type: none"> ○ Status <ul style="list-style-type: none"> ▪ Command
<ul style="list-style-type: none"> ❑ Command <ul style="list-style-type: none"> ○ SystemRun/Stop ○ TempSetpt ○ EmgStopReset ○ ForcePriPumpMode



13.1. Basic Commanding

1. Press the Home Button  to show the “MainMenu” screen.

MainMenu	1/4
Status	▶
Setting	▶
ConfigMode	▶
Password	▶

2. On the “MainMenu” screen, turn the click-dial  to select “Status” menu then press down on the click-dial  to jump to “Status” screen.

MainMenu	1/4
Status	▶
Setting	▶
ConfigMode	▶
Password	▶

3. On the “Status” screen, turn the click-dial  to select “Command” menu then press down on the click-dial  to jump to “Command” screen.

Status	1/22
Command	▶
-Status	Standby
-Alarm	-
-FaultType	-----

4. On the “Command” screen, various commands can be sent.

Command	1/9
---------	-----



SystemRun/Stop	Run	← a.
-ActiveValue	Run	← b.
TempSetpt	7.0° C	← c.
-ActiveValue	7.0° C	← d.
EmgStopReset	▶	← 13.2 Resetting emergency stop
ForcePriPumpMode	OFF	← e.
-ActiveValue	-	← f.
ForceCndPumpMode	OFF	← g.
-ActiveValue	-	← h.

Table 56 List of parameters which can be set from “Command” screen

ID	Name	Definition
a.	SystemRun/Stop	Run/Stop command for iCM system
b.	-ActiveValue	Currently active command signal
c.	TempSetpt	Temperature setpoint command
d.	-ActiveValue	Currently active setpoint
e.	ForcePriPumpMode	ON/OFF command for force primary pump run
f.	-ActiveValue	Currently active command signal
g.	ForceCndPumpMode	ON/OFF command for force condenser pump run
h.	-ActiveValue	Currently active command signal

13.2. Resetting emergency stop

(Used screen: “MainMenu > Status > Command > EmgStopReset”)

1. On the “MainMenu > Status > Command” screen, turn the click-dial  to select “EmgStopReset” menu then press down on the click-dial  to jump to “EmgStopReset” screen.

Command	5/9
-ActiveValue	Run
TempSetpt	7.0° C
-ActiveValue	7.0° C
EmgStopReset	▶

2. On the “EmgStopReset” screen you can reset emergency stop. In order to reset emergency stop state, emergency stop signal input from BACnet needs to be OFF.

EmgStopReset	1/3	
EmgStopReset	-	← a.
-Status	E-Stop	← b.
-EmgStopFromBACnet	OFF	← c.



Table 57 List of parameters which can be set from “Command” screen

ID	Name	Definition
a.	EmgStopReset	Reset command for emergency stop state



b.	-Status	Check if current status is emergency stop
c.	- EmgStopFromBACnet	Check current status of emergency stop command from BACnet

13.3. Setting Chillers to “Maintenance”



Steps for setting chillers to “Maintenance” mode to exclude them from staging are described below.

1. On the “MainMenu” screen, turn the click-dial  to select “Status” menu then press down on the click-dial  to jump to “Status” screen.



	MainMenu	1/4
	Status	▶
	Setting	▶
	ConfigMode	▶
	Password	▶

2. On the “Status” screen, turn the click-dial  to select “Chiller” menu then press down on the click-dial  to jump to “Chiller Status” screen.



◆	Status	13/22
	Chiller	▶
	EvShutOffValve	▶
	CndShutOffValve	▶
	PrimaryPump	▶

3. On the “Chiller status” screen, turn the click-dial  to select the chiller you need to set to “Maintenance” mode then press down on the click-dial  to jump to “ChillerXX Detail” screen.

	Chiller Status	2/9			
	R/S	Alm	Cap		
#01	R	Stop	20%	▶	
#02	M R	Stop	Comm	0%	▶
#03	L	Stop	Dev	20%	▶

4. On the “ChillerXX Detail” screen, turn the click-dial  to select the “Maintenance” menu then press down on the click-dial  to jump to input mode screen for “Maintenance”.

◆	Chiller01 Detail	5/12
	Maintenance	-
	-State	-
	ActualCapacity	20%
	Remote/Local	Remote

- On the input mode screen for “Maintenance”, turn the click-dial  to change value (“-” for returning from Maintenance mode, or “Maintenance” to set the chiller to Maintenance mode) then press down on the click-dial  to validate your setting.

Chiller01 Detail	1/1
Maintenance	-



Chiller01 Detail	1/1
Maintenance	Maintenance

- On the “ChillerXX Detail” screen, look at “-State” menu below “Maintenance” to check if the setting has successfully been processed. Be careful when setting chillers back from Maintenance mode as when chiller is under alarm, they will be forced to be Maintenance mode and can’t be set back.

 Chiller01 Detail	5/12
Maintenance	Maintenance
-State	Maintenance
ActualCapacity	20%
Remote/Local	Remote



14. Alarming

14.1. Showing Current List of Alarms

Steps for showing the current list of alarms are described below.

1. Press the Alarm button  to show the “Alarming” screen.

	Alarming	1/3
AlarmList		99 ▶
AlarmHistory		99 ▶
-ClearHistory		-



2. On the “Alarming” screen, turn the click-dial  to select “AlarmList” menu then press down on the click-dial  to jump to “AlarmList” screen.

	Alarming	1/3
AlarmList		99 ▶
AlarmHistory		99 ▶
-ClearHistory		-

3. On the “AlarmList” screen, current list of alarms are shown. Types of alarms that are displayed are: chiller alarms, pump alarms, and system alarms. Refer to the Appendix for alarm codes for each type.

	AlarmList	
+127: Chiller01 Device Error		▶
+998: Pump08 Monitoring Error		▶
+10111: Piping Gr#01 not enough pumps available to meet minimum		▶

←Alarm Index of chiller is shown

- To see the details of individual alarms, simply select the alarm on the “AlarmList” screen by turning the click-dial  and jump to the “AlarmList Detail” screen by pressing down on the click-dial .

AlarmList	
+127: Chiller01 Device Error	▶
+998: Pump08 Monitoring Error	▶
+10111: Piping Gr#01 not enough pumps available to meet minimum	▶



AlarmList Detail	
+121: Chiller01 Device Error	
10/15/2014	23:12:29

14.2. Showing History of Alarms

Steps for showing the history of alarms are described below.

- Press the Alarm button  to show the “Alarming” screen.

Alarming		1/3
AlarmList		99 ▶
AlarmHistory		99 ▶
-ClearHistory		-



- On the “Alarming” screen, turn the click-dial  to select “AlarmHistory” menu then press down on the click-dial  to jump to “AlarmHistory” screen.

Alarming		1/3
AlarmList		99 ▶
AlarmHistory		99 ▶
-ClearHistory		-

- On the “AlarmHistory” screen, history of alarms are shown

AlarmHistory	
+127: Chiller01 Device Error	▶
-127: Chiller01 Device Error	▶
+10111: Piping Gr#01 not enough pumps available to meet minimum	▶

← “+” sign indicates occurrence
 ← “-” sign indicates recovery

4. To see the details of individual alarms, simply select the alarm on the “AlarmList” screen by turning the click-dial  and jump to the “AlarmHistory Detail” screen by pressing down on the click-dial .

AlarmHistory	
+127: Chiller01 Device Error	▶
-127: Chiller01 Device Error	▶
+10111: Piping Gr#01 not enough pumps available to meet minimum	▶



AlarmHistory Detail	
+127: Chiller01 Device Error	
10/15/2014	23:12:29



← Date and time of event is shown

14.3. Deleting History of Alarms



Steps for deleting the history of alarms are described below.

1. Press the Alarm button  to show the “Alarming” screen.

Alarming		1/3
AlarmList		99▶
AlarmHistory		99▶
-ClearHistory		-

2. On the “Alarming” screen, turn the click-dial  to select “-ClearHistory” menu then press down on the click-dial  to jump to input mode screen for “-ClearHistory”

Alarming		1/3
AlarmList		99▶
AlarmHistory		99▶
-ClearHistory		-

- On the input mode screen for “-ClearHistory”, turn the click-dial  to select “clear” then press down on the click-dial  to validate your command.

Alarming	1/1
-ClearHistory	



Alarming	1/1
-ClearHistory	Clear

- History of alarms will be cleared.

Alarming	1/3
AlarmList	99 ▶
AlarmHistory	0 ▶
-ClearHistory	-

14.4. Resetting Alarms

Steps for resetting alarms on chillers are described below. Chillers have 3 kinds of errors; device error, communication error and monitoring error. Among the 3 kinds of errors, device error (Alarm detected at the chiller) can be reset from iCM. Communication error and monitoring error can be reset by restoring communication status between iCM and chillers to match command from iCM and status of each device.



There are 2 steps for resetting alarms

- Alarm Reset
- Setting Chillers back from maintenance status

A. Alarm Reset



- Press the Home Button  to show the “MainMenu” screen.

MainMenu	1 
Status	▶
Setting	▶
ConfigMode	▶
Password	▶



- On the “MainMenu” screen, turn the click-dial  to select “Status” menu then press down on the click-dial  to jump to “Status” screen.

MainMenu	1 
----------	---



Status	▶
Setting	▶
ConfigMode	▶
Password	▶

3. On the “Status” screen, turn the click-dial  to select “Chiller” menu then press down on the click-dial  to jump to “Chiller Status” screen.



◀▶ Status	11	🔔
Chiller	▶	
EvShutOffValve	▶	
CndShutOffValve	▶	
PrimaryPump	▶	

4. On the “Chiller status” screen, turn the click-dial  to select the chiller you need to reset alarm then press down on the click-dial  to jump to “ChillerXX Detail” screen.

Chiller Status	3	🔔
R/S	Alm	Cap
#01 R Stop		20%
#02 M R Stop	Dev	0%
#03 L Stop	Comm	20%

5. On the “ChillerXX Detail” screen, turn the click-dial  to select the “Alarm reset” menu then press down on the click-dial  to jump to input mode screen for “Alarm reset”.

▼ Chiller01 Detail	4	🔔
Run/Stop	Stop	
Alarm	DevE	
-ErrorCode	E402	
-AlarmReset	-	

6. On the input mode screen for “AlarmReset”, turn the click-dial  to change value to “Reset” then press down on the click-dial  to validate your setting.

Chiller01 Detail	1	🔔
-AlarmReset	-	



Chiller01 Detail	1	🔔
-AlarmReset	Reset	

7. On the “ChillerXX Detail” screen, look at “Alarm” menu to check if the alarm has successfully been reset.

▼	Chiller01 Detail	4	
	Run/Stop		Stop
	Alarm		-
	-ErrorCode		--
	-AlarmReset		-

NOTE: While the conditions that triggered the alarm is true, you will not be able to reset the alarm.

15. APPENDIX – Alarms

15.1. Alarm Codes

15.1.1. Alarm for the chiller system

Alarm for the system includes hardware errors of the iCM itself or chiller system not being able to satisfy A/C load due to failure of multiple equipment.

The error code of chiller system alarm is described in a six-digits decimal alarm code e.g. 000101.

Category ₀	Category ₁	Category ₂	Alarm text	Alarm Code	Description			
	Ext I/O Module Disconnect (01)		101: Extension IO module#01 disconnect (ExtIO#01)	000101	Module Disconnected			
			102: Extension IO module#02 disconnect (ExtIO#02)	000102	Module Disconnected			
			103: Extension IO module#03 disconnect (ExtIO#03)	000103	Module Disconnected			
			104: Extension IO module#04 disconnect (ExtIO#04)	000104	Module Disconnected			
			105: Extension IO module#05 disconnect (ExtIO#05)	000105	Module Disconnected			
			106: Extension IO module#06 disconnect (ExtIO#06)	000106	Module Disconnected			
			109: Extension IO module#09 disconnect (ExtIO#09)	000109	Module Disconnected			
			110: Extension IO module#10 disconnect (ExtIO#10)	000110	Module Disconnected			
			111: Extension IO module#11 disconnect (ExtIO#11)	000111	Module Disconnected			
			112: Extension IO module#12 disconnect (ExtIO#12)	000112	Module Disconnected			
			113: Extension IO module#13 disconnect (ExtIO#13)	000113	Module Disconnected			
			114: Extension IO module#14 disconnect (ExtIO#14)	000114	Module Disconnected			
			115: Extension IO module#15 disconnect (ExtIO#15)	000115	Module Disconnected			
			116: Extension IO module#16 disconnect (ExtIO#16)	000116	Module Disconnected			
			Comm Module Disconnect (02)		202: BACnet module disconnect (BACnet)	000202	Module Disconnected	
			Loop (1)	Loop1 (01)		10101: Emergency stop command On	010101	I/O fault
						10102: All pumps are under maintenance	010102	I/O fault
	10103: 10103: All cond. Pumps are under maintenance	010103				I/O fault		
	Loop1 (01)	Shortage of flow (1)		10111: PipingGr#01 not enough pumps available to meet minimum	010111	Pump fault		
				10112: PipingGr#02 not enough pumps available to meet minimum	010112	Pump fault		
				10113: PipingGr#03 not enough pumps available to meet minimum	010113	Pump fault		
				10114: PipingGr#04 not enough pumps available to meet minimum	010114	Pump fault		
	Loop1 (01)	Shortage of cooling water flow (2)		10121: Cond. PipingGr#01 not enough pumps available to meet minimum	010121	Condenser pump fault		
				10122: Cond. PipingGr#02 not enough pumps available to meet minimum	010122	Condenser pump fault		
				10123: Cond. PipingGr#03 not enough pumps available to meet minimum	010123	Condenser pump fault		
			10124: Cond. PipingGr#04 not enough pumps available to meet minimum	010124	Condenser pump fault			
	Ai (2)	Main controller (00)		20002: Leaving water temp. setpoint command port failure (Base X2)	020002	I/O fault		
20006: Leaving water temp. sensor failure (Base X6)				020006	I/O fault			
20007: Entering water temp. sensor failure (Base X7)				020007	I/O fault			
20008: Header differential pressure sensor failure (Base X8)				020008	I/O fault			
Ext9 (09)			20901: Entering condenser water temp. sensor#01 failure (ExtIO#09 X1)	020901	I/O fault			
			20902: Entering condenser water temp. sensor#02 failure (ExtIO#09 X2)	020902	I/O fault			
			20903: Leaving condenser water temp. sensor#01 failure (ExtIO#09 X3)	020903	I/O fault			
			20904: Leaving condenser water temp. sensor#02 failure (ExtIO#09 X4)	020904	I/O fault			
			20905: Condenser water differential pressure sensor#01 failure (ExtIO#09 X5)	020905	I/O fault			
			20906: Condenser water differential pressure sensor#02 failure (ExtIO#09 X6)	020906	I/O fault			
			20907: Outdoor temp. sensor failure (ExtIO#09 X7)	020907	I/O fault			

Ext10 (10)	21001: Entering condenser water temp. sensor#03 failure (ExtIO#10 X1)	021001	I/O fault	
	21002: Entering condenser water temp. sensor#04 failure (ExtIO#10 X2)	021002	I/O fault	
	21003: Leaving condenser water temp. sensor#03 failure (ExtIO#10 X3)	021003	I/O fault	
	21004: Leaving condenser water temp. sensor#04 failure (ExtIO#10 X4)	021004	I/O fault	
	21005: Condenser water differential pressure sensor#03 failure (ExtIO#10 X5)	021005	I/O fault	
	21006: Condenser water differential pressure sensor#04 failure (ExtIO#10 X6)	021006	I/O fault	
Main controller (00)	21001: Entering condenser water temp. sensor#03 failure (ExtIO#10 X1)	021001	I/O fault	
	30001: iCM Run/Stop command port failure (Base X1)	030001	I/O fault	
	30003: Emergency stop command port failure (Base X3)	030003	I/O fault	
	30005: Double setpoint command port failure (Base X5)	030005	I/O fault	
	30011: Force primary pump on command port failure (Base DI1)	030011	I/O fault	
	30012: Force condenser pump on command port failure (Base DI2)	030012	I/O fault	
	Ext1 (01)	30102: Pump#01 On/Off status port failure (ExtIO#01 X2)	030102	I/O fault
		30103: Pump#01 Alarm status port failure (ExtIO#01 X3)	030103	I/O fault
		30105: Pump#02 On/Off status port failure (ExtIO#01 X5)	030105	I/O fault
		30106: Pump#02 Alarm status port failure (ExtIO#01 X6)	030106	I/O fault
	Ext2 (02)	30202: Pump#03 On/Off status port failure (ExtIO#02 X2)	030202	I/O fault
		30203: Pump#03 Alarm status port failure (ExtIO#02 X3)	030203	I/O fault
30205: Pump#04 On/Off status port failure (ExtIO#02 X5)		030205	I/O fault	
30206: Pump#04 Alarm status port failure (ExtIO#02 X6)		030206	I/O fault	
Ext3 (03)	30302: Pump#05 On/Off status port failure (ExtIO#03 X2)	030302	I/O fault	
	30303: Pump#05 Alarm status port failure (ExtIO#03 X3)	030303	I/O fault	
	30305: Pump#06 On/Off status port failure (ExtIO#03 X5)	030305	I/O fault	
	30306: Pump#06 Alarm status port failure (ExtIO#03 X6)	030306	I/O fault	
Ext4 (04)	30402: Pump#07 On/Off status port failure (ExtIO#04 X2)	030402	I/O fault	
	30403: Pump#07 Alarm status port failure (ExtIO#04 X3)	030403	I/O fault	
	30405: Pump#08 On/Off status port failure (ExtIO#04 X5)	030405	I/O fault	
	30406: Pump#08 Alarm status port failure (ExtIO#04 X6)	030406	I/O fault	
Ext5 (05)	30501: Shut off valve#01 Open/Close status port failure (ExtIO#05 X1)	030501	I/O fault	
	30502: Shut off valve#02 Open/Close status port failure (ExtIO#05 X2)	030502	I/O fault	
	30503: Shut off valve#03 Open/Close status port failure (ExtIO#05 X3)	030503	I/O fault	
	30504: Shut off valve#04 Open/Close status port failure (ExtIO#05 X4)	030504	I/O fault	
	30505: Shut off valve#01 Alarm status port failure (ExtIO#05 X5)	030505	I/O fault	
	30506: Shut off valve#02 Alarm status port failure (ExtIO#05 X6)	030506	I/O fault	
	30507: Shut off valve#03 Alarm status port failure (ExtIO#05 X7)	030507	I/O fault	
	30508: Shut off valve#04 Alarm status port failure (ExtIO#05 X8)	030508	I/O fault	
Ext6 (06)	30601: Shut off valve#05 Open/Close status port failure (ExtIO#06 X1)	030601	I/O fault	
	30602: Shut off valve#06 Open/Close status port failure (ExtIO#06 X2)	030602	I/O fault	
	30603: Shut off valve#07 Open/Close status port failure (ExtIO#06 X3)	030603	I/O fault	
	30604: Shut off valve#08 Open/Close status port failure (ExtIO#06 X4)	030604	I/O fault	
	30605: Shut off valve#05 Alarm status port failure (ExtIO#06 X5)	030605	I/O fault	
	30606: Shut off valve#06 Alarm status port failure (ExtIO#06 X6)	030606	I/O fault	
	30607: Shut off valve#07 Alarm status port failure (ExtIO#06 X7)	030607	I/O fault	
	30608: Shut off valve#08 Alarm status port failure (ExtIO#06 X8)	030608	I/O fault	
Ext11 (11)	31105: Cond. pump#01 On/Off status port failure (ExtIO#11 X5)	031105	I/O fault	
	31106: Cond. pump#02 On/Off status port failure (ExtIO#11 X6)	031106	I/O fault	
	31107: Cond. pump#01 Alarm status port failure (ExtIO#11 X7)	031107	I/O fault	
	31108: Cond. pump#02 Alarm status port failure (ExtIO#11 X8)	031108	I/O fault	
Ext12 (12)	31205: Cond. pump#03 On/Off status port failure (ExtIO#12 X5)	031205	I/O fault	
	31206: Cond. pump#04 On/Off status port failure (ExtIO#12 X6)	031206	I/O fault	
	31207: Cond. pump#03 Alarm status port failure (ExtIO#12 X7)	031207	I/O fault	
	31208: Cond. pump#04 Alarm status port failure (ExtIO#12 X8)	031208	I/O fault	
Ext13 (13)	31305: Cond. pump#05 On/Off status port failure (ExtIO#13 X5)	031305	I/O fault	
	31306: Cond. pump#06 On/Off status port failure (ExtIO#13 X6)	031306	I/O fault	

Di
(3)

	Ext14 (14)	31307: Cond. pump#05 Alarm status port failure (ExtIO#13 X7)	031307	I/O fault	
		31308: Cond. pump#06 Alarm status port failure (ExtIO#13 X8)	031308	I/O fault	
		31405: Cond. pump#07 On/Off status port failure (ExtIO#14 X5)	031405	I/O fault	
		31406: Cond. pump#08 On/Off status port failure (ExtIO#14 X6)	031406	I/O fault	
		31407: Cond. pump#07 Alarm status port failure (ExtIO#14 X7)	031407	I/O fault	
	Ext15 (15)	31408: Cond. pump#08 Alarm status port failure (ExtIO#14 X8)	031408	I/O fault	
		31501: Cond. shut off valve#01 Open/Close status port failure (ExtIO#15 X1)	031501	I/O fault	
		31502: Cond. shut off valve#02 Open/Close status port failure (ExtIO#15 X2)	031502	I/O fault	
		31503: Cond. shut off valve#03 Open/Close status port failure (ExtIO#15 X3)	031503	I/O fault	
		31504: Cond. shut off valve#04 Open/Close status port failure (ExtIO#15 X4)	031504	I/O fault	
		31505: Cond. shut off valve#01 Alarm status port failure (ExtIO#15 X5)	031505	I/O fault	
		31506: Cond. shut off valve#02 Alarm status port failure (ExtIO#15 X6)	031506	I/O fault	
		31507: Cond. shut off valve#03 Alarm status port failure (ExtIO#15 X7)	031507	I/O fault	
	Ext16 (16)	31508: Cond. shut off valve#04 Alarm status port failure (ExtIO#15 X8)	031508	I/O fault	
		31601: Cond. shut off valve#05 Open/Close status port failure (ExtIO#16 X1)	031601	I/O fault	
		31602: Cond. shut off valve#06 Open/Close status port failure (ExtIO#16 X2)	031602	I/O fault	
		31603: Cond. shut off valve#07 Open/Close status port failure (ExtIO#16 X3)	031603	I/O fault	
		31604: Cond. shut off valve#08 Open/Close status port failure (ExtIO#16 X4)	031604	I/O fault	
		31605: Cond. shut off valve#05 Alarm status port failure (ExtIO#16 X5)	031605	I/O fault	
		31606: Cond. shut off valve#06 Alarm status port failure (ExtIO#16 X6)	031606	I/O fault	
		31607: Cond. shut off valve#07 Alarm status port failure (ExtIO#16 X7)	031607	I/O fault	
	Ao (4)	Main controller (00)	40004: Byp. valve Open Rate command port failure (Base X4)	040004	I/O fault
		Ext1 (01)	40101: Pump#01 VFD command port failure (ExtIO#01 X1)	040101	I/O fault
			40104: Pump#02 VFD command port failure (ExtIO#01 X4)	040104	I/O fault
		Ext2 (02)	40201: Pump#03 VFD command port failure (ExtIO#02 X1)	040201	I/O fault
			40204: Pump#04 VFD command port failure (ExtIO#02 X4)	040204	I/O fault
		Ext3 (03)	40301: Pump#05 VFD command port failure (ExtIO#03 X1)	040301	I/O fault
			40304: Pump#06 VFD command port failure (ExtIO#03 X4)	040304	I/O fault
		Ext4 (04)	40401: Pump#07 VFD command port failure (ExtIO#04 X1)	040401	I/O fault
			40404: Pump#08 VFD command port failure (ExtIO#04 X4)	040404	I/O fault
		Ext11 (11)	41101: Cond. Pump#01 VFD command port failure (ExtIO#11 X1)	041101	I/O fault
41102: Cond. Pump#02 VFD command port failure (ExtIO#11 X2)			041102	I/O fault	
41103: Cond. Byp. valve#01 Open Rate command port failure (ExtIO#11 X3)			041103	I/O fault	
41104: Cond. Byp. valve#02 Open Rate command port failure (ExtIO#11 X4)			041104	I/O fault	
Ext12 (12)		41201: Cond. Pump#03 VFD command port failure (ExtIO#12 X1)	041201	I/O fault	
	41202: Cond. Pump#04 VFD command port failure (ExtIO#12 X2)	041202	I/O fault		
	41203: Cond. Byp. valve#03 Open Rate command port failure (ExtIO#12 X3)	041203	I/O fault		
	41204: Cond. Byp. valve#04 Open Rate command port failure (ExtIO#12 X4)	041204	I/O fault		
Ext13 (13)	41301: Cond. Pump#05 VFD command port failure (ExtIO#13 X1)	041301	I/O fault		
	41302: Cond. Pump#06 VFD command port failure (ExtIO#13 X2)	041302	I/O fault		
Ext14 (14)	41401: Cond. Pump#07 VFD command port failure (ExtIO#14 X1)	041401	I/O fault		

			41402: Cond. Pump#08 VFD command port failure (ExtIO#14 X2)	041402	I/O fault
Do (5)	Main (00)	Controller	50021: iCM Run/Stop status port failure (Base DO1)	050021	I/O fault
			50022: iCM Alarm status port failure (Base DO2)	050022	I/O fault

15.1.2. Alarms for individual equipment

Alarm for individual equipment, chillers, pumps, valves, cooling towers and sensors, is displayed in the HMI. For each type of equipment, types of errors that are displayed include all or part of the following.

- Communication error:
Communication with the equipment is lost
- Device error :
Alarm signal from the equipment is received.
- Monitoring error:
The equipment did not follow a command from iCM
- Warning:
Warning signal from the equipment is received

Types of alarms that are displayed for each equipment type and their corresponding error codes are shown in the following table.

	Chiller		Shut off valve	Pump (I/O)	Bypass valve	Condenser pump	CT shutoff valve
	Modbus	I/O					
Communication error	Error code: 999	N/A	N/A	N/A	N/A	N/A	N/A
Device error	Error code: Received from chiller	Error code: 997	Error code: 997	Error code: 997	N/A	Error code: 997	Error code: 997
Monitoring error	Error code: 998	Error code: 998	Error code: 998	Error code: 998	N/A	Error code: 998	Error code: 998
Warning	Error code: Received from chiller	N/A	N/A	N/A	N/A	N/A	N/A

16. APPENDIX – BACnet Integration Data (Main Controller)

Category			Name	Obj Type	Description
System	Monitoring	Alarm	iCM system alarm	BI	General alarm
			iCM system alarm code	AI	iCM System Alarm List code
		Status	iCM system status	MI	iCM Status Global
			iCM system ON/OFF status	BI	iCM Syson
			iCM system setpoint	AI	Active cold setpoint
			iCM system load	AI	System load
			Source of input status for ON/OFF	MI	Loc/remote mode of iCM Network on/off
			Source of input status for chilled water temperature setpoint	MI	Loc/remote mode of iCM Cold setpoint
			Source of input status for force primary pump on	MI	Loc/remote mode of iCM ChW pump force on
			Status of double setpoint signal	BI	Double setpoint digital input
			Differential pressure	AI	Chilled water loop pressure difference
			Chilled water leaving temperature	AI	Chilled water leaving temperature before header
	Chilled water return temperature	AI	Chilled water return temperature before header		
	Command	iCM system ON/OFF command	BO	iCM Network on/off	
		iCM chilled water temperature setpoint	AV	iCM Cold setpoint	
Force primary pump on		BO	iCM Force Chilled water pump ON		
Emergency stop		BO	iCM Emergency stop		
Emergency stop reset		BV	iCM Emergency stop reset		
Chiller	Monitoring	Alarm	Alarm status	BI	Active Unit Alarm Ch
			Alarm code	AI	Alarm Code Ch
			Alarm reset	BO	Clear Alarm Ch
	Status	ON/OFF status	BI	Chiller On/Off	
		Actual capacity	AI	Load unit	
		Chilled water return temperature	AI	Chilled water return temperature unit	
		Chilled water leaving temperature	AI	Chilled water leaving temperature unit	
Pump	Monitoring	Alarm	Alarm status	BI	Chilled water pump Alarm
		Status	ON/OFF status	BI	Chilled water Pump On/Off
		VFD capacity status	AI	Chilled water Pump VFD output	
Bypass Valve	Monitoring	Status	Open rate status	AI	Load bypass valve position
Shut-off Valve	Monitoring	Alarm	Alarm status	BI	Shut-off valve Alarm
		Status	Open/Close status	BI	Shut-off valve Open/Close

17. APPENDIX – HMI Monitoring and Command

Points available for reading and writing from HMI is described below

Category		Name	Description	
System	Monitoring	Alarm	iCM system alarm	General alarm
			iCM system alarm code	iCM System Alarm List code
		Status	iCM system status	iCM Status Global
			iCM system ON/OFF status	iCM Sys On
			iCM system setpoint	Active cold setpoint
			iCM system load	System load
			Differential pressure	Chilled water loop pressure difference
			Chilled water leaving temperature	Chilled water leaving temperature before header
			Chilled water return temperature	Chilled water return temperature before header
	Stage up inhibit status	Stage up inhibit by pull-down rate control		
	Command	iCM system ON/OFF command	iCM Network on/off	
		iCM chilled water temperature setpoint	iCM Cold setpoint	
		Force primary pump on	iCM Force Chilled water pump ON	
		Emergency stop reset	iCM Emergency stop reset	
Chiller	Monitoring	Alarm	Alarm status	Active Unit Alarm Ch
			Alarm code	Alarm Code Ch
			Alarm reset	Clear Alarm Ch
	Status	ON/OFF status	ON/OFF status of each chiller	
		Operation mode	Operation mode of each chiller	
		Chilled water setpoint	Chilled water setpoint of each chiller	
		Actual capacity	Actual capacity of each chiller	
		Operation hours	Accumulated operation hours of each chiller	
		Remote/local status	Remote/local status of each chiller	
		Available status	Available status of each chiller	
		Chilled water return temperature	Chilled water return temperature unit	
Chilled water leaving temperature	Chilled water leaving temperature unit			
Shut-off Valve	Monitoring	Alarm	Alarm status	Alarm status of each shut off valve
		Status	Open/Close status	Open/Close status of each shut off valve
			Available status	Available status of each shut off valve
Primary Pump	Monitoring	Alarm	Alarm status	Alarm status of each primary pump
		Status	ON/OFF status	ON/OFF status of each primary pump
			VFD capacity	VFD output of each primary pump
			Available status	Available status of each primary pump
	Command	Operation hours	Accumulated operation hour of each pri. pump	
		ON/OFF command	ON/OFF command for each condenser pump	
		Capacity command	Capacity command for each condenser pump	

Bypass Valve (Evaporator)		Capacity command	Capacity command for each condenser pump	Load bypass valve position
Bypass Valve (Cooling)	Monitoring	Status	Bypass valve open rate	Load bypass valve position
Condenser pump	Monitoring	Alarm	Alarm status	Alarm status of each condenser pump
		Status	ON/OFF status	ON/OFF status of each condenser pump
			VFD capacity	VFD output of each condenser pump
			Available status	Available status of each condenser pump
			Operation hours	Accumulated operation hr. of each con. pump
	Command	ON/OFF command	ON/OFF command for each condenser pump	
		Capacity command	Capacity command for each condenser pump	
Condenser bypass valve	Monitoring	Status	Open rate status	Open rate of each condenser bypass valve
		Command	Open rate command	Open rate command of each condenser bypass valve

18. APPENDIX – I/O Mapping

The I/O mapping of the main controller and I/O modules are listed below.

Main Controller (POL687.70)

I/O name	System related I/O's	I/O type	Specification
AI1	Unused	Ai	
AI2	Unused	Ai	
AI3	Unused	Ai	
X1	System ON/OFF command	Di	non-voltage a-contact input
X2	Temperature setpoint	Ai	4-20mA input
X3	Forced stoppage input	Di	non-voltage b-contact input
X4	Bypass Valve Open Command	Ao	4 - 20mA output
X5	Double Setpoint ON/OFF	Di	non-voltage a-contact input
X6	Chilled Water Leaving Temperature	Ai	4 - 20mA input
X7	Chilled Water Entering Temperature	Ai	4 - 20mA input
X8	Differential Pressure	Ai	4 - 20mA input
DO1	System ON/OFF status	Do	non-voltage a-contact output
DO2	System alarm	Do	non-voltage a-contact output
DO3	Unused	Do	
DO4	Unused	Do	
DO5	Unused	Do	
DO6	Unused	Do	
DO7	Unused	Do	
DO8	Unused	Do	
DO9	Unused	Do	
DO10	Unused	Do	
DI1	Primary pump force operation	Di	non-voltage a-contact output
DI2	Cooling water pump force operation	Di	non-voltage a-contact output
DI3	Unused	Di	
DI4	Unused	Di	
DI5	Unused	Di	
DI6	Unused	Di	

I/O module #1 (POL965)

I/O name	Primary pumps 1 and 2	I/O type	Specification
X1	Pri. pump1 VFD command	Ao	4 - 20mA input
X2	Pri. pump1 ON/OFF status	Di	non-voltage a-contact input
X3	Pri. pump1 alarm	Di	non-voltage a-contact input
X4	Pri. pump2 VFD command	Ao	4 - 20mA input
X5	Pri. pump2 ON/OFF status	Di	non-voltage a-contact input
X6	Pri. pump2 alarm	Di	non-voltage a-contact input
X7	Unused	Do	
X8	Unused	Do	
DO1	Pri. pump1 ON/OFF command	Do	non-voltage a-contact output
DO2	Pri. pump2 ON/OFF command	Do	non-voltage a-contact output
DO3	Unused	Do	
DO4	Unused	Do	
DO5	Unused	Do	
DO6	Unused	Do	
DI1	Unused	Di	

I/O module #2 (POL965)

I/O name	Primary pumps 3 and 4	I/O type	Specification
X1	Pri. pump3 VFD command	Ao	4 - 20mA input
X2	Pri. pump3 ON/OFF status	Di	non-voltage a-contact input
X3	Pri. pump3 alarm	Di	non-voltage a-contact input
X4	Pri. pump4 VFD command	Ao	4 - 20mA input
X5	Pri. pump4 ON/OFF status	Di	non-voltage a-contact input
X6	Pri. pump4 alarm	Di	non-voltage a-contact input
X7	Unused	Do	
X8	Unused	Do	
DO1	Pri. pump3 ON/OFF command	Do	non-voltage a-contact output
DO2	Pri. pump4 ON/OFF command	Do	non-voltage a-contact output
DO3	Unused	Do	
DO4	Unused	Do	
DO5	Unused	Do	
DO6	Unused	Do	
DI1	Unused	Di	

I/O module #3 (POL965)

I/O name	Primary pumps 5 and 6	I/O type	Specification
X1	Pri. pump5 VFD command	Ao	4 - 20mA input
X2	Pri. pump5 ON/OFF status	Di	non-voltage a-contact input
X3	Pri. pump5 alarm	Di	non-voltage a-contact input
X4	Pri. pump6 VFD command	Ao	4 - 20mA input
X5	Pri. pump6 ON/OFF status	Di	non-voltage a-contact input
X6	Pri. pump6 alarm	Di	non-voltage a-contact input
X7	Unused	Do	
X8	Unused	Do	
DO1	Pri. pump5 ON/OFF command	Do	non-voltage a-contact output
DO2	Pri. pump6 ON/OFF command	Do	non-voltage a-contact output
DO3	Unused	Do	
DO4	Unused	Do	
DO5	Unused	Do	
DO6	Unused	Do	
DI1	Unused	Di	

I/O module #4 (POL965)

I/O name	Primary pumps 7 and 8	I/O type	Specification
X1	Pri. pump7 VFD command	Ao	4 - 20mA input
X2	Pri. pump7 ON/OFF status	Di	non-voltage a-contact input
X3	Pri. pump7 alarm	Di	non-voltage a-contact input
X4	Pri. pump8 VFD command	Ao	4 - 20mA input
X5	Pri. pump8 ON/OFF status	Di	non-voltage a-contact input
X6	Pri. pump8 alarm	Di	non-voltage a-contact input
X7	Unused	Do	
X8	Unused	Do	
DO1	Pri. pump7 ON/OFF command	Do	non-voltage a-contact output
DO2	Pri. pump8 ON/OFF command	Do	non-voltage a-contact output
DO3	Unused	Do	
DO4	Unused	Do	
DO5	Unused	Do	
DO6	Unused	Do	
DI1	Unused	Di	

I/O module #5 (POL965)

I/O name	Evaporator Shut-off valves 1, 2, 3 and 4	I/O type	Specification
X1	Shut-off valve1 Open/Close status	Di	non-voltage a-contact input
X2	Shut-off valve2 Open/Close status	Di	non-voltage a-contact input
X3	Shut-off valve3 Open/Close status	Di	non-voltage a-contact input
X4	Shut-off valve4 Open/Close status	Di	non-voltage a-contact input
X5	Shut-off valve1 alarm	Di	non-voltage a-contact input
X6	Shut-off valve2 alarm	Di	non-voltage a-contact input
X7	Shut-off valve3 alarm	Di	non-voltage a-contact input
X8	Shut-off valve4 alarm	Di	non-voltage a-contact input
DO1	Shut-off valve1 Open/Close command	Do	non-voltage a-contact output
DO2	Shut-off valve2 Open/Close command	Do	non-voltage a-contact output
DO3	Shut-off valve3 Open/Close command	Do	non-voltage a-contact output
DO4	Shut-off valve4 Open/Close command	Do	non-voltage a-contact output
DO5	Unused	Do	
DO6	Unused	Do	
DI1	Unused	Di	

I/O module #6 (POL965)

I/O name	Evaporator Shut-off valves 5, 6, 7 and 8	I/O type	Specification
X1	Shut-off valve5 Open/Close status	Di	non-voltage a-contact input
X2	Shut-off valve6 Open/Close status	Di	non-voltage a-contact input
X3	Shut-off valve7 Open/Close status	Di	non-voltage a-contact input
X4	Shut-off valve8 Open/Close status	Di	non-voltage a-contact input
X5	Shut-off valve5 alarm	Di	non-voltage a-contact input
X6	Shut-off valve6 alarm	Di	non-voltage a-contact input
X7	Shut-off valve7 alarm	Di	non-voltage a-contact input
X8	Shut-off valve8 alarm	Di	non-voltage a-contact input
DO1	Shut-off valve5 Open/Close command	Do	non-voltage a-contact output
DO2	Shut-off valve6 Open/Close command	Do	non-voltage a-contact output
DO3	Shut-off valve7 Open/Close command	Do	non-voltage a-contact output
DO4	Shut-off valve8 Open/Close command	Do	non-voltage a-contact output
DO5	Unused	Do	
DO6	Unused	Do	
DI1	Unused	Di	

I/O module #9 (POL965)

I/O name	Cooling water system 1 and 2 Temperature and differential pressure sensors	I/O type	Specification
X1	Cooling water chiller entering temperature 1	Ai	4 - 20mA input / NTC 10K input
X2	Cooling water chiller entering temperature 2	Ai	4 - 20mA input / NTC 10K input
X3	Cooling water chiller leaving temperature 1	Ai	4 - 20mA input / NTC 10K input
X4	Cooling water chiller leaving temperature 2	Ai	4 - 20mA input / NTC 10K input
X5	Cooling water differential pressure 1	Ai	4 - 20mA input
X6	Cooling water differential pressure 2	Ai	4 - 20mA input
X7	Outdoor temperature	Ai	4 - 20mA input / NTC 10K input
X8	Unused	-	
DO1	Unused	Do	
DO2	Unused	Do	
DO3	Unused	Do	
DO4	Unused	Do	
DO5	Unused	Do	
DO6	Unused	Do	
DI1	Unused	Di	

I/O module #10 (POL965)

I/O name	Cooling water system 3 and 4 Temperature and differential pressure sensors	I/O type	Specification
X1	Cooling water chiller entering temperature 3	Ai	4 - 20mA input / NTC 10K input
X2	Cooling water chiller entering temperature 4	Ai	4 - 20mA input / NTC 10K input
X3	Cooling water chiller leaving temperature 3	Ai	4 - 20mA input / NTC 10K input
X4	Cooling water chiller leaving temperature 4	Ai	4 - 20mA input / NTC 10K input
X5	Cooling water differential pressure 3	Ai	4 - 20mA input
X6	Cooling water differential pressure 4	Ai	4 - 20mA input
X7	Unused	-	
X8	Unused	-	
DO1	Unused	Do	
DO2	Unused	Do	
DO3	Unused	Do	
DO4	Unused	Do	
DO5	Unused	Do	
DO6	Unused	Do	
DI1	Unused	Di	

I/O module #11 (POL965)

I/O name	Cooling water pumps 1 and 2	I/O type	Specification
X1	Cooling water pump 1 capacity command	Ao	4 - 20mA output
X2	Cooling water pump 2 capacity command	Ao	4 - 20mA output
X3	Cooling water bypass valve 1 open rate command	Ao	4 - 20mA output
X4	Cooling water bypass valve 2 open rate command	Ao	4 - 20mA output
X5	Cooling water pump 1 on/off status	Di	non-voltage a-contact input
X6	Cooling water pump 2 on/off status	Di	non-voltage a-contact input
X7	Cooling water pump 1 fault status	Di	non-voltage a-contact input
X8	Cooling water pump 2 fault status	Di	non-voltage a-contact input
DO1	Cooling water pump 1 on/off command	Do	non-voltage a-contact output
DO2	Cooling water pump 2 on/off command	Do	non-voltage a-contact output
DO3	Unused	Do	
DO4	Unused	Do	
DO5	Unused	Do	
DO6	Unused	Do	
DI1	Unused	Di	

I/O module #12 (POL965)

I/O name	Cooling water pumps 3 and 4	I/O type	Specification
X1	Cooling water pump 3 capacity command	Ao	4 - 20mA output
X2	Cooling water pump 4 capacity command	Ao	4 - 20mA output
X3	Cooling water bypass valve 3 open rate command	Ao	4 - 20mA output
X4	Cooling water bypass valve 4 open rate command	Ao	4 - 20mA output
X5	Cooling water pump 3 on/off status	Di	non-voltage a-contact input
X6	Cooling water pump 4 on/off status	Di	non-voltage a-contact input
X7	Cooling water pump 3 fault status	Di	non-voltage a-contact input
X8	Cooling water pump 4 fault status	Di	non-voltage a-contact input
DO1	Cooling water pump 3 on/off command	Do	non-voltage a-contact output
DO2	Cooling water pump 4 on/off command	Do	non-voltage a-contact output
DO3	Unused	Do	
DO4	Unused	Do	
DO5	Unused	Do	
DO6	Unused	Do	
DI1	Unused	Di	

I/O module #13 (POL965)

I/O name	Cooling water pumps 5 and 6	I/O type	Specification
X1	Cooling water pump 5 capacity command	Ao	4 - 20mA output
X2	Cooling water pump 6 capacity command	Ao	4 - 20mA output
X3	Unused	-	
X4	Unused	-	
X5	Cooling water pump 5 on/off status	Di	non-voltage a-contact input
X6	Cooling water pump 6 on/off status	Di	non-voltage a-contact input
X7	Cooling water pump 5 fault status	Di	non-voltage a-contact input
X8	Cooling water pump 6 fault status	Di	non-voltage a-contact input
DO1	Cooling water pump 5 on/off command	Do	non-voltage a-contact output
DO2	Cooling water pump 6 on/off command	Do	non-voltage a-contact output
DO3	Unused	Do	
DO4	Unused	Do	
DO5	Unused	Do	
DO6	Unused	Do	
DI1	Unused	Di	

I/O module #14 (POL965)

I/O name	Cooling water pumps 7 and 8	I/O type	Specification
X1	Cooling water pump 7 capacity command	Ao	4 - 20mA output
X2	Cooling water pump 8 capacity command	Ao	4 - 20mA output
X3	Unused	-	
X4	Unused	-	
X5	Cooling water pump 7 on/off status	Di	non-voltage a-contact input
X6	Cooling water pump 8 on/off status	Di	non-voltage a-contact input
X7	Cooling water pump 7 fault status	Di	non-voltage a-contact input
X8	Cooling water pump 8 fault status	Di	non-voltage a-contact input
DO1	Cooling water pump 7 on/off command	Do	non-voltage a-contact output
DO2	Cooling water pump 8 on/off command	Do	non-voltage a-contact output
DO3	Unused	Do	
DO4	Unused	Do	
DO5	Unused	Do	
DO6	Unused	Do	
DI1	Unused	Di	

I/O module #15 (POL965)

I/O name	Condenser Shut-off valves 1, 2, 3 and 4	I/O type	Specification
X1	Cooling water side shut-off valve 1 open/close status	Di	non-voltage a-contact input
X2	Cooling water side shut-off valve 2 open/close status	Di	non-voltage a-contact input
X3	Cooling water side shut-off valve 3 open/close status	Di	non-voltage a-contact input
X4	Cooling water side shut-off valve 4 open/close status	Di	non-voltage a-contact input
X5	Cooling water side shut-off valve 1 fault	Di	non-voltage a-contact input
X6	Cooling water side shut-off valve 2 fault	Di	non-voltage a-contact input
X7	Cooling water side shut-off valve 3 fault	Di	non-voltage a-contact input
X8	Cooling water side shut-off valve 4 fault	Di	non-voltage a-contact input
DO1	Cooling water side shut-off valve 1 open/close command	Do	non-voltage a-contact output
DO2	Cooling water side shut-off valve 2 open/close command	Do	non-voltage a-contact output
DO3	Cooling water side shut-off valve 3 open/close command	Do	non-voltage a-contact output
DO4	Cooling water side shut-off valve 4 open/close command	Do	non-voltage a-contact output
DO5	Unused	Do	
DO6	Unused	Do	
DI1	Unused	Di	

I/O module #16 (POL965)

I/O name	Condenser Shut-off valves 5, 6, 7 and 8	I/O type	Specification
X1	Cooling water side shut-off valve 5 open/close status	Di	non-voltage a-contact input
X2	Cooling water side shut-off valve 6 open/close status	Di	non-voltage a-contact input
X3	Cooling water side shut-off valve 7 open/close status	Di	non-voltage a-contact input
X4	Cooling water side shut-off valve 8 open/close status	Di	non-voltage a-contact input
X5	Cooling water side shut-off valve 5 fault	Di	non-voltage a-contact input
X6	Cooling water side shut-off valve 6 fault	Di	non-voltage a-contact input
X7	Cooling water side shut-off valve 7 fault	Di	non-voltage a-contact input
X8	Cooling water side shut-off valve 8 fault	Di	non-voltage a-contact input
DO1	Cooling water side shut-off valve 5 open/close command	Do	non-voltage a-contact output
DO2	Cooling water side shut-off valve 6 open/close command	Do	non-voltage a-contact output
DO3	Cooling water side shut-off valve 7 open/close command	Do	non-voltage a-contact output
DO4	Cooling water side shut-off valve 8 open/close command	Do	non-voltage a-contact output
DO5	Unused	Do	
DO6	Unused	Do	
DI1	Unused	Di	

19. APPENDIX – Compatibility List

List of Daikin chillers that can be connected and managed by iCM is as follow:

Product Name	Product Code	Controller	Compatibility
AWS	EWAD_C	MT 3 ¹	Y (*)
AWS INV	EWAD_CZ	MT 3	Y (*)
AWS FC	EWAD_CF	MT 3	Y (**)
TZ	EWAD_TZ	MT 3	Y (*)
TZB	EWAD_TZB	MT 3	Y (*)
McENERGY HPI	EWYD_BZ	MT 2 ²	N
McENERGY Mono	EWAD_E	MT 3	Y (*)
McENERGY Dual	EWAD_D	MT 3	Y (*)
WHS-E	EWWD_I	MT 3	Y (*)
Ecoplus	EWWD_G	MT 3	Y (*)
Prox Evo	EWWQ_B	MT 3	Y
WHB	EWWD_J	MT 3	Y (*)
PFS	EWWD_H	MT 3	Y
VZ	EWWD_VZ	MT 3	Y (*)
WCZ Mono	EWWQ_G	MT 3	Y (*)
WCZ Dual	EWWQ_L	MT 3	Y (*)
WCZ HPI	EWHQ_G	MT 3	N
ACZ-C Multiple Scroll CO	EWAQ_E	MT 3	Y
ACZ-H Multiple Scroll HP	EWYQ_F	MT 3	N
AGZ-C Multiple Scroll CO	EWAQ_G	MT 3	Y (*)
AGZ-H Multiple Scroll HP	EWYQ_G	MT 3	N
WSC – Centrifugal Single	DWSC	MT 2	Y
WDC – Centrifugal Dual	DWDC	MT 2	Y
WMC – Centrifugal Magnetic	DWMC	MT 2	Y

Table 58 – Compatibility List

(*): **NOTE 1:** iCM can manage chillers with **Partial Heat Recovery option**, but cannot manage chillers with **Total Heat Recovery option**.

(**): **NOTE 2:** iCM can manage chillers with Free-cooling option, but the function itself is managed by chiller controller (not centralized).

¹ MT 3: MicroTech 3 Unit controller

² MT 2: MicroTech 2 Unit controller

20. APPENDIX – Integrated Modbus Points

The list of Modbus points integrated to iCM is listed below.

20.1. Global chillers

The list of status monitoring points for (formerly) McQuay global chillers are shown below.

Register		Name
Address	Bit	
40002	b0	Chiller Enable Output
40008	b0	Chiller On/Off
40011	-	Chiller Mode Output
40013	-	Actual Capacity(3)
40012	-	Active Setpoint
40028	-	Warming Alarm Index
40029	-	Problem Alarm Index
40030	-	Fault Alarm Index
40031	-	Warning Alarm Code
40032	-	Problem Alarm Code
40033	-	Fault Alarm Code
40016	-	Evaporator Entering Fluid Temperature (5)
40017	-	Evaporator Leaving Fluid Temperature (6)
40001	b0	Chiller Local/Remote

The list of control command points for (formerly) McQuay global chillers are shown below.

Register		Name
Address	Bit	
40009	b0	Chiller Enable Setpoint
40034	-	Chiller Mode Setpoint – Network
40035	-	Cool Setpoint – Network
40010	b0	Clear Alarms – Network
40316	b0	Units

20.2. U.S. Chillers

The list of status monitoring points for (formerly) McQuay U.S. chillers are shown below.

Register		Name
Address	Bit	
3	-	Chiller On Off
3	-	Chiller On/Off
40148	-	Chiller Mode Output
40011	-	Actual Capacity
40003	-	Active Setpoint
40130	b1~b9	Warnings
40131~40132	b0~b15	Problems
40133~40144	b5~b4	Faults
40130	b1~b9	Warning Alarm Code
40131~40132	b0~b15	Problem Alarm Code
40133~40144	b5~b4	Fault Alarm Code
40130	b1~b9	Warning Alarm Index
40131~40132	b0~b15	Problem Alarm Index
40133~40144	b5~b4	Fault Alarm Index
40005	-	Evaporator Entering Water Temperature
40007	-	Evaporator Leaving Water Temperature for Unit
6	-	Chiller Local/Remote

The list of control command points for (formerly) McQuay U.S. chillers are shown below.

Register		Name
Address	Bit	
2	-	Chiller Enable
40146	-	Chiller Mode Setpoint
40002	-	Cool Setpoint
25	-	Clear Alarms

NOTE

NOTE

The present publication is drawn up by of information only and does not constitute an offer binding upon Daikin Applied Europe S.p.A.. Daikin Applied Europe S.p.A. has compiled the content of this publication to the best of its knowledge. No express or implied warranty is given for the completeness, accuracy, reliability or fitness for particular purpose of its content, and the products and services presented therein. Specification are subject to change without prior notice. Refer to the data communicated at the time of the order. Daikin Applied Europe S.p.A. explicitly rejects any liability for any direct or indirect damage, in the broadest sense, arising from or related to the use and/or interpretation of this publication. All content is copyrighted by Daikin Applied Europe S.p.A..

DAIKIN APPLIED EUROPE S.p.A.

Via Piani di Santa Maria, 72 - 00072 Ariccia (Roma) - Italia

Tel: (+39) 06 93 73 11 - Fax: (+39) 06 93 74 014

<http://www.daikinapplied.eu>