

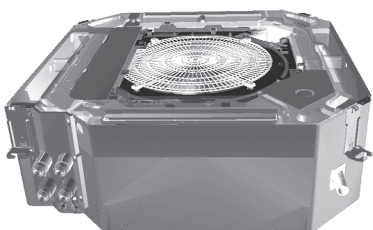

INSTALLATION MANUAL

Fan coil units

FWC06B7TV1B
FWC07B7TV1B
FWC08B7TV1B
FWC09B7TV1B
FWC06B7FV1B
FWC07B7FV1B
FWC08B7FV1B
FWC09B7FV1B



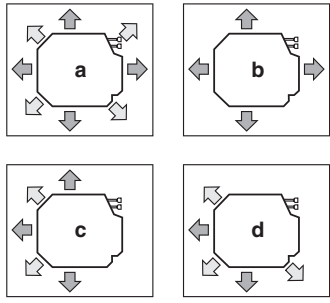

1

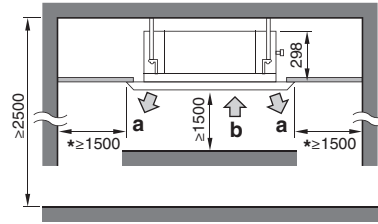

2

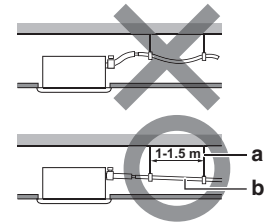

3

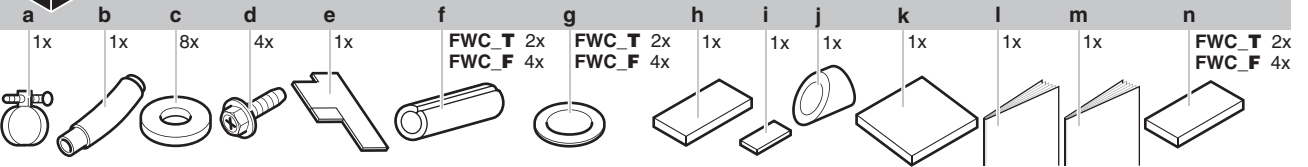

4

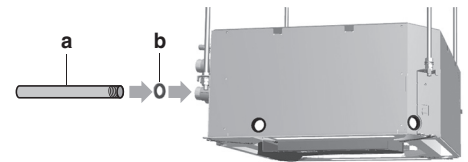

5

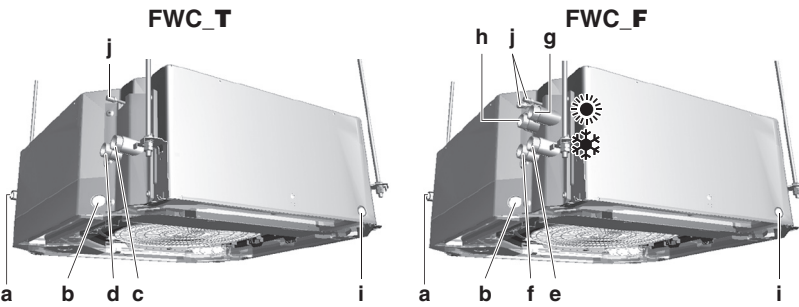

6

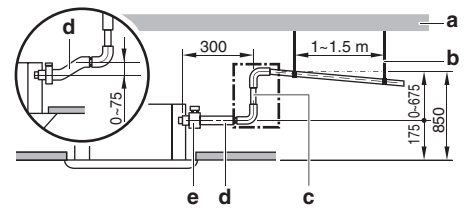

7

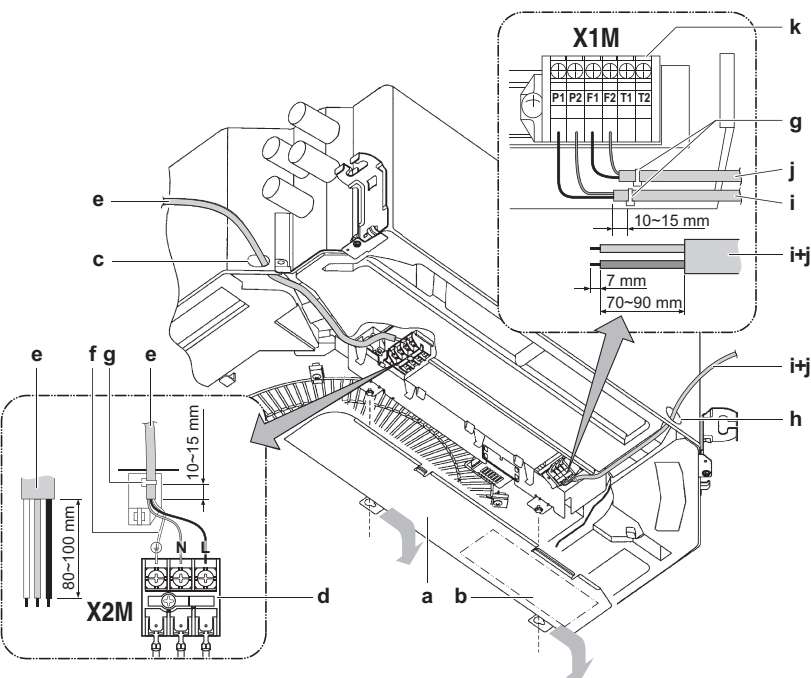

9

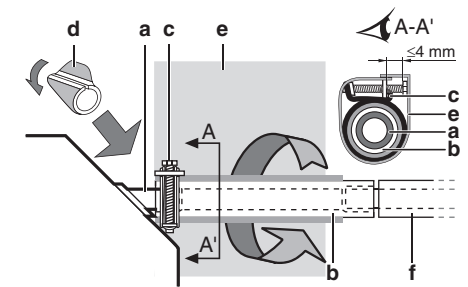

8

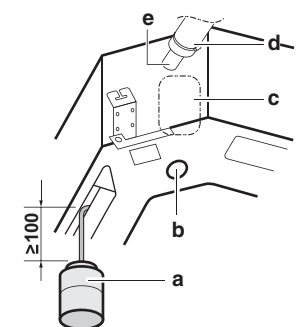

10

Table of contents

1	Introduction	1
1.1.	About fan coil units	1
1.2.	About this fan coil unit	1
1.3.	About this document	1
1.3.1.	Meaning of warnings and symbols	2
2	Precautions for installation	2
3	Prepare the installation of the fan coil unit	2
3.1.	Check that you have all optional equipment	2
3.2.	Verify the appropriate installation location	3
3.3.	Prepare the installation space	3
3.4.	Prepare the water piping work	3
3.5.	Prepare the electrical wiring work	4
3.6.	Prepare the installation of optional equipment	4
4	Install the fan coil unit	4
4.1.	Unpack the unit	4
4.2.	Check if all accessories are included	5
4.3.	Prepare the ceiling opening	5
4.4.	Fix the unit	5
4.5.	Perform the water piping work	6
4.5.1.	Connect the water pipes	6
4.5.2.	Insulate the water pipes	6
4.5.3.	Fill the water circuit	7
4.6.	Connect the electrical wiring	7
4.6.1.	Connect the power supply	8
4.6.2.	Connect the remote controller and unit transmission wiring	8
4.6.3.	Close the control box	8
4.7.	Perform the drain piping work	8
4.7.1.	Install the drain piping in the building	8
4.7.2.	Connect the drain piping to the unit	9
4.7.3.	Test the drain piping	9
4.8.	Install optional equipment	9
5	Commission the fan coil unit	10
5.1.	Verify completion of installation	10
5.2.	Configure the unit	11
5.3.	Test the installation	11
5.4.	Handover to the user	11
6	Service and maintenance	12
6.1.	Maintenance tasks	12
6.2.	Service to the unit	12
7	Glossary	12

1 Introduction

1.1. About fan coil units

A fan coil unit provides heating and/or cooling to individual spaces. It creates a comfortable environment in both commercial and residential applications. Fan coil units are widely used for the air conditioning of offices, hotels and houses.

The main components of fan coil units are:

- a fan,
- a heat exchanger.

The heat exchanger receives hot or cold water from a heating or cooling source.

DAIKIN offers a wide range of fan coil units for both concealed and exposed applications. Contact your DAIKIN dealer for a list of related products.

1.2. About this fan coil unit

The model identification code means:

FW	C	06	B	7	T	V1	B
-----------	----------	-----------	----------	----------	----------	-----------	----------

FW	Water fan coil unit
C	Subclass: Cassette C: 3x3
06	Total cooling capacity (kW)
B	Major model change
7	Minor model change
T	Coil type: T: 2-pipe F: 4-pipe
V1	1 phase / 50 Hz / 220-240 V
B	Produced in Europe

The following models are available:

- FWC06-07-08-09B7TV1B
2-pipe fan coil units have a single-circuit heat exchanger. The device can be used for either cooling **or** heating.
- FWC06-07-08-09B7FV1B
4-pipe fan coil units have a double-circuit heat exchanger. The units can be connected to both cooling **and** heating systems. Use this type if you have a separate source for cooling and for heating.

1.3. About this document

This document is an installation manual. It is intended for the installer of this product. It describes the procedures for installing, commissioning and maintaining the unit, and it will provide help if problems occur. Carefully read the relevant parts of the manual.

How to get the manual?

- A printed version of the manual is delivered with the unit.
- Contact your local DAIKIN dealer for an electronic version of the manual.

For detailed instructions about how to install and operate the associated products and/or optional equipment, refer to the relevant catalogues, technical literature or product manuals for those products. The original documentation is written in English. All other languages are translations of the original documentation.

1.3.1. Meaning of warnings and symbols

Warnings in this manual are classified according to their severity and probability of happening.



Danger: Indicates an imminently hazardous situation which, if not avoided, will result in death or serious injury.



Warning: Indicates a potentially hazardous situation which, if not avoided, could result in death or serious injury.



Caution: Indicates a potentially hazardous situation which, if not avoided, may result in minor or moderate injury.



Notice: Indicates situations that may result in damage to equipment or property.



Information: This symbol identifies useful information, but no hazardous situation warnings.

Some types of danger are represented by special symbols:



Electric current



Danger of burning or scalding

2 Precautions for installation

All instructions described in this manual shall be carried out by a licensed installer.

Install the unit according to the instructions in the included documentation and the manuals of the additional equipment (e.g. controller). Improper installation could result in electric shock, short-circuit, leaks, fire or other damage to the equipment.

Be sure to wear adequate personal protection equipment (protection gloves, safety glasses) when performing installation, maintenance or service to the unit.

If not sure of installation procedures or operation of the unit, always contact your local DAIKIN dealer for advice and information.



Danger: electric shock

Switch off all power supply before removing the control box cover or before making any connections or touching electrical parts.

To avoid electric shock, be sure to disconnect the power supply 1 minute or more before servicing the electrical parts. Even after 1 minute, always measure the voltage at the terminals of main circuit capacitors or electrical parts and, before touching, be sure that those voltages are 50 V DC or less.



Danger: high temperature

Do not touch the water piping or internal parts during and immediately after operation. The piping and internal parts may be hot or cold depending on the working condition of the unit.

Your hand may get burned or frostbitten if you touch the piping or internal parts. To avoid injury, give the piping and internal parts time to return to normal temperature or, if you must touch them, be sure to wear adequate protective gloves.

3 Prepare the installation of the fan coil unit

3.1. Check that you have all optional equipment

Mandatory equipment per fan coil unit: Each fan coil unit must be equipped with one of these decoration panels.

Decoration panel	Identification code	Description
Decoration panel - standard	BYCQ140CW1	Decoration panel for the fan coil unit with normal sealing colour.
Decoration panel - white	BYCQ140CW1W	Decoration panel for the fan coil unit with white sealings.

Mandatory equipment: Each fan coil unit must be connected to at least one of the listed controllers.

Controllers	Identification code	Description
Electronic remote controller - wireless (cooling and heating)	BRC7F532F	Wireless remote controller to control each fan coil unit independently with cooling and heating functionality.
Electronic remote controller - wireless (cooling only)	BRC7F533F	Wireless remote controller to control each fan coil unit independently with cooling functionality only.
Electronic remote controller - wired	BRC315D7 ^(a)	Wired remote controller to control each fan coil unit with cooling and heating functionality.
Central remote controller	DCS302CA51 ^(a)	Remote controller for centralized control of all connected units.
Intelligent touch controller	DCS601C51C ^(a)	Advanced remote controller for centralized control of all connected units.
Unified ON/OFF controller	DCS301BA51 ^(a)	Remote controller to switch all connected units ON or OFF.

^(a) For installation of these options, an installation box option kit may be required. See option list in the data book for more information.

Optional Equipment to extend the life of your product

Air handling options	Identification code	Description
Sealing member of air discharge outlet	KDBHQ55C140	Blocking parts to close one or more air outlets of the fan coil unit.
Long-life replacement filter	KAFP551K160	High quality filter.
Fresh air intake kit	KDDQ55C140	Kit which can be connected to the ventilation system in order to supply fresh air to the fan coil unit.

Prepare the installation of the fan coil unit

Sensor	Identification code	Description
Remote temperature sensor	KRCS01-4	Replacement sensor to measure temperature remotely from a location other than that in which the controller is installed.

Timer	Identification code	Description
Schedule timer	DST301BA51 ^(a)	Controller with schedule timing functionality.

^(a) For installation of these options, an installation box option kit may be required. See option list in the data book for more information.

Valves	Identification code	Description
2-way valve (ON/OFF type)	EKMV2C09B7	Electronic 2-way valve to control the water supply (+EKRP1C11).
3-way valve (ON/OFF type)	EKMV3C09B7	Electronic 3-way valve to control the water supply (+EKRP1C11).

Electronic circuits	Identification code	Description
Valve control PCB	EKRP1C11 ^(a)	Mandatory electronic circuit when 2-way or 3-way valve is used.
Optional PCB for Modbus connection	EKFCMBCB7 ^(a)	Electronic circuit with Modbus interface connections.
Wiring adaptor for electrical appendices	KRP4A(A)53 KRP2A52 ^(a)	Electronic circuit with additional connections for external input/output signals.

^(a) For installation of these options, an installation box option kit may be required. See option list in the data book for more information.

3.2. Verify the appropriate installation location

When selecting the installation location, take into account the instructions as mentioned in the following paragraphs of this chapter. Select an installation location where the following conditions are fulfilled:

- the space around the unit is adequate for maintenance and servicing. See figure 2: "Space required for installation".
- the space around the unit allows sufficient air circulation and air distribution. See figure 2: "Space required for installation".
- the unit may be installed on ceilings up to 4.2 m. However, it becomes necessary to make field settings using the remote controller when installing the unit at a height over 3.2 m. Install the unit where the height of the decoration panel is more than 2.5 m to avoid accidental touching.
- the air passage is not blocked.
- the condensate water can be properly drained.
- the installation location is frost-free.
- the unit can be installed horizontally.
- the unit must be installed as far away as possible from fluorescent lights or other sources that possibly interfere with the signal of wireless remote controllers.

See figure 2: "Space required for installation"

- a Air outlet
- b Air inlet



Information

Leave 200 mm or more space where marked with *, on sides where the air outlet is closed. Refer to figure 2: "Space required for installation".



Information

The equipment is not intended for use in a potentially explosive atmosphere.

3.3. Prepare the installation space

- When preparing the installation space, use the paper pattern for installation which is delivered with the unit. More information on how to prepare the ceiling opening can be found in chapter "Prepare the ceiling opening" on page 5.
- When the conditions in the built-in space are exceeding 30°C and exceeding a relative humidity of 80%, or when fresh air is inducted into the ceiling, an additional insulation is required on the outside of the unit (minimum 10 mm thickness polyethylene foam).

3.4. Prepare the water piping work

The unit is equipped with a water inlet and water outlet for connection to a water circuit. The water circuit must be provided by an installer and must comply with the applicable legislation.



Notice

The unit is only to be used in a closed water system. Application in an open water circuit can lead to excessive corrosion of the water piping.

Before performing the water piping work, check the following points:

- the maximum water pressure is 10 bar,
- the minimum water temperature is 5°C,
- the maximum water temperature is 50°C (2-pipe fan coil units) and 70°C (4-pipe fan coil units),
- be sure to install components in the field piping that can withstand the water pressure and temperature,
- provide adequate safeguards in the water circuit to be sure that the water pressure will never exceed the maximum allowable working pressure,
- provide a proper drain for the pressure relief valve (if installed) to avoid any water coming into contact with electrical parts,
- be sure that the water flow rates are according to the table below,

	Minimum water speed (l/min.)	Maximum water speed (l/min.)
FWC06-09B7TV1B	5.4	36
FWC06-09B7FV1B	5.4	36 cooling coil + 18 heating coil

Table 3.1: Maximum and minimum water flow

- provide shut-off valves at the unit so that normal servicing can be accomplished without draining the system,
- provide drain taps at all low points of the system to permit complete drainage of the circuit during maintenance or service to the unit,
- provide air purge valves at all high points of the system. The valves shall be located at points which are easily accessible for servicing. A manual air purge valve is mounted onto the unit,
- always use materials which are compatible with the water and a maximum of 40% volume glycol,
- select piping diameter in relation to required water flow and available ESP (External Static Pressure) of the system pump.

3.5. Prepare the electrical wiring work

The unit must be connected to the power supply. All field wiring and components must be installed by an installer and must comply with the applicable legislation.



Warning

A main switch or other means for disconnection, having a contact separation in all poles, must be incorporated in the fixed wiring in accordance with the applicable legislation.

Before connecting the electrical wiring, check the following points:

- use copper wires only,
- all field wiring must be carried out in accordance with the wiring diagram delivered with the unit,
- never squeeze bundled cables and be sure that cables do not come in contact with the piping and sharp edges. Be sure no external pressure is applied to the terminal connections,
- be sure to establish an earth. Do not earth the unit to a utility pipe, surge absorber, or telephone earth. Incomplete earth may cause electrical shock,
- be sure to install an earth leakage detector in accordance with the applicable legislation. Failure to do so may cause electric shock or fire. The earth leakage detector is a field supplied part,
- be sure to install the required fuses or circuit breakers. The fuse or circuit breakers are field supplied parts.



Information

The equipment described in this manual may cause electronic noise generated from radio-frequency energy. The equipment complies to specifications that are designed to provide reasonable protection against such interference. However, there is no guarantee that interference will not occur in a particular installation.

It is therefore recommended to install the equipment and electric wires keeping proper distances away from stereo equipment, personal computers, etc.

In extreme circumstances a distance of 3 m or more is required.

Electrical characteristics

Model	FWC
Phase	1N~
Frequency (Hz)	50
Voltage range (V)	220-240
Voltage tolerance (V)	±10%
Maximum running current (A)	0.9
Overcurrent fuse (A) (field supply)	16 ^(a)

Table 3.2: Electrical characteristics

^(a) In case of common power supply to more than one unit (as illustrated in figure 13: "Group control or use with 2 remote controllers"), keep total current of interconnection wiring between units less than 12 A. Branch the line outside the terminal block of the unit in accordance with electrical equipment standards, when using two power wires of a gauge greater than 2 mm². The branch must be sheathed in order to provide an equal or greater degree of insulation as power supply wiring itself.

Specifications for field wiring

	Wire	Size (mm ²)	Length
Power supply wiring	H05VV-U3G ^{(a),(b)}	According to the applicable legislation. Max. 4.0	—
Remote controller and unit transmission wiring	Sheathed wire 2 conductors ^(c)	0.75-1.25	Max. 500 m ^(d)

Table 3.3: Field wiring specifications

^(a) Only in case of protected pipes. Use H07RN-F in case of no protection.

^(b) Run electrical wiring through a conduit to protect against external forces.

^(c) Use double insulation wire for remote controller (sheath thickness: ≥1 mm) or run wires through a wall or conduit so that the user cannot come in contact with them.

^(d) This length is the total extended length in the system in case of group control. See figure 13: "Group control or use with 2 remote controllers".

3.6. Prepare the installation of optional equipment

Air flow directions

For this unit you can select different air flow directions. It is necessary to purchase an optional blocking pad kit to limit the air discharge to 2, 3 or 4 (closed corners) directions.

Select the air flow directions best suited for the room and point of installation. For air discharge in 2 or 3 directions, it is necessary to make field settings by means of the remote controller and to close the air outlet(s) as illustrated in figure 1: "Airflow directions". (↑ air flow direction)

- a All-round air discharge
- b Air discharge in 4 directions
- c Air discharge in 3 directions
- d Air discharge in 2 directions



Information

Air flow directions as shown merely serve as examples of possible air flow directions.

For other preparations related to the installation of optional equipment refer to "Install optional equipment" on page 9.

4 Install the fan coil unit

4.1. Unpack the unit

When receiving the unit, please check its state. Verify if any damage occurred during transport. If the unit and/or packing are damaged at delivery, report this immediately to the carrier's claims agent.

Identify model and version of the unit from the indications stated on the carton packing.

Leave the unit inside its packing until you reach the installation site.

Where unpacking is unavoidable, use a sling of soft material or protective plates together with a rope when lifting, this to avoid damage or scratches to the unit.



Warning

Tear apart and throw away plastic packaging bags so that children will not play with them. Children playing with plastic bags face danger of death by suffocation.

When unpacking the unit or when moving the unit after unpacking, be sure to lift the unit by holding on to the hanger bracket without exerting any pressure on other parts.

Install the fan coil unit

4.2. Check if all accessories are included

An overview of the accessories included in the box (see figure 4: "Accessories"):

- a Metal clamp
- b Drain hose
- c Washer for hanger bracket
- d Screw
- e Installation guide
- f Insulation tube
- g O-ring
- h Large sealing pad
- i Small sealing pad
- j Drain sealing pad
- k Paper pattern for installation (printed on upper part of packing)
- l Installation manual
- m User manual
- n Sealing pad for piping connections

4.3. Prepare the ceiling opening

See figure 11: "Opening in ceiling"

- a Water inlet/outlet
- b Suspension bolt (x4) (field supply)
- c Hanger bracket
- d Suspended ceiling
- e Distance between suspension bolts
- f Unit dimensions
- g Ceiling opening dimensions
- h Decoration panel dimensions
- i Suspended ceiling frame



Information

Installation is possible with a ceiling dimension of 910 mm (marked with * in figure 11: "Opening in ceiling"). However, to achieve a ceiling-panel overlapping dimension of 20 mm, the spacing between the ceiling and the unit should be 35 mm or less. If the spacing between ceiling and the unit is over 35 mm, attach sealing material or recovered ceiling in the area marked below.

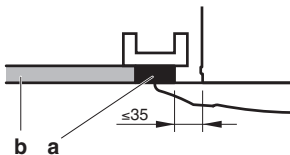

Fig. 4.1: Ceiling spacing too large

- a Area to fit sealing material or recovered ceiling into
- b Suspended ceiling

- 1 Make the ceiling opening needed for installation where applicable. (For existing ceilings.)
 - Refer to the paper pattern for installation (delivered with the unit) for the ceiling opening dimensions.
 - Create the ceiling opening required for installation.

- After making an opening in the ceiling, it may be necessary to reinforce the suspended ceiling frame to keep the ceiling level and to prevent it from vibrating. Consult the builder for details.

- 2 Install the suspension bolts. (Use either a W3/8 or M10 size bolt.)

Use anchors for existing ceilings, and a sunken insert, sunken anchors or other field supplied parts for new ceilings to reinforce the ceiling in order to bear the weight of the unit. The distance between the suspension bolts is marked on the paper pattern for installation (delivered with the unit). Refer to it to check for points requiring reinforcing. Adjust clearance from the ceiling before proceeding further. See installation example in figure 14: "Installing the suspension bolts":

- a Ceiling slab
- b Anchor
- c Long nut or turn-buckle
- d Suspension bolt
- e Suspended ceiling



Information

- All the above parts are field supplied.
- For installation other than standard installation, contact your local DAIKIN dealer for advice.

4.4. Fix the unit



Caution

To avoid injury, do not touch the air inlet or aluminium fins of the unit.

When installing optional equipment, also read the installation manual of the optional equipment. Depending on the field conditions, it may be easier to install optional equipment before the unit is installed. However, for existing ceilings, always install fresh air intake kit before installing the unit. For more information, refer to "Install optional equipment" on page 9.

- 1 Install the unit temporarily.

Attach the hanger bracket to the suspension bolt. Be sure to fix it securely by using a nut and washer from the upper and lower sides of the hanger bracket as illustrated in figure 15: "Securing the hanger bracket".

- a Nut (field supply)
- b Washer (delivered with the unit)
- c Hanger bracket
- d Double nut (field supply)

- 2 Fix the paper pattern for installation (delivered with the unit). (For new ceilings only.)

- The paper pattern for installation corresponds with the measurements of the ceiling opening. Consult the builder for details.
- The centre of the ceiling opening is indicated on the paper pattern for installation. The centre of the unit is indicated on the unit casing.
- Attach the paper pattern for installation to the unit with the screws as illustrated in figure 16: "Paper pattern for installation".

- a Paper pattern for installation (delivered with the unit)
- b Centre of the ceiling opening
- c Centre of the unit
- d Screws (delivered with the unit)

- 3 Adjust the unit to the right position for installation.
Use the installation guide (delivered with the unit) for exact vertical positioning of the unit.
- Apply the short side of the installation guide in case of **normal installation** as illustrated below.

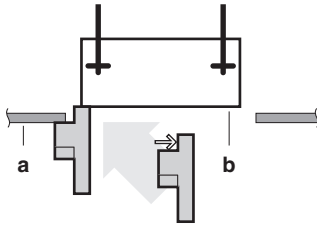

Fig. 4.2: Normal installation

- a Suspended ceiling
- b Fan coil unit

- Apply the long side of the installation guide in case of **installation with fresh air intake kit** as illustrated below.

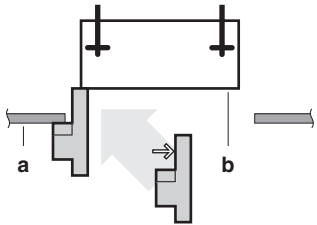

Fig. 4.3: Installation with fresh air intake

- a Suspended ceiling
- b Fan coil unit

- 4 Check if the unit is horizontally levelled.
- Do not install the unit tilted. The unit is equipped with a built-in drain pump and float switch. If the unit is tilted against the direction of the condensate flow (the drain piping side is raised), the float switch may malfunction and cause water to drip.
 - Check if the unit is levelled at all four corners with a water level or a water-filled vinyl tube as illustrated in the figure below.

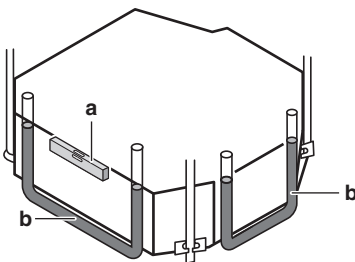

Fig. 4.4: Check if unit is levelled

- a Water level
- b Vinyl tube

- 5 Remove the paper pattern for installation. (For new ceilings only.)

4.5. Perform the water piping work

4.5.1. Connect the water pipes

The unit is equipped with water outlet and inlet connections. There is an air purge valve that is fitted along with the water inlets and outlets for air purging as illustrated in figure 6: "Water piping connection".

- a Drain pipe connection
- b Power supply entry hole
- c Water inlet (3/4" female BSP)
- d Water outlet (3/4" female BSP)
- e Cold water inlet (3/4" female BSP)
- f Cold water outlet (3/4" female BSP)
- g Hot water inlet (3/4" female BSP)
- h Hot water outlet (3/4" female BSP)
- i Transmission wiring entry
- j Air purge valve

Connect the water inlet and outlet connections of the fan coil unit to the water piping as illustrated in figure 5: "Connecting the water piping".

- Water piping:
 - 3/4" male BSP in case of direct connection to the unit,
 - 3/4" female BSP in case of connection to an optional valve.
- b O-ring (delivered with the unit)



Notice

Do not use excessive force when connecting the piping. This could deform the unit piping. Deformation of the piping can cause the unit to malfunction.

In case the optional valve is used, refer to the installation manual of the valve kit to install the field piping.

4.5.2. Insulate the water pipes

The complete water circuit, inclusive all piping, must be insulated to prevent condensation and reduction of the capacity.

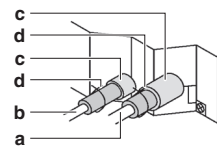

Fig. 4.5: Water piping insulation

- a Water inlet
- b Water outlet
- c Sealing pad for piping connections (delivered with the unit)
- d Insulation tube (delivered with the unit)

If the temperature is higher than 30°C and the relative humidity is higher than 80%, then the thickness of the sealing materials shall be at least 20 mm in order to avoid condensation on the surface of the sealing.

Install the fan coil unit

4.5.3. Fill the water circuit



Notice

Water quality must be according to EU directive 98/83 EC.



Notice

Use of glycol is allowed, but the amount shall not exceed 40% of the volume. A higher amount of glycol may cause damage to the hydraulic components.

During filling, it might not be possible to remove all air in the system. Remaining air can be removed during the first operating hours of the unit. The air can be removed from the unit through the manual air purge valve. For the location of the air purge valve on the unit, refer to figure 6: "Water piping connection".

- 1 Open the air purge valve (refer to figure "Air purge valve") by turning the nut 2 times.
- 2 Push the springy core (refer to figure "Air purge valve") to let off superfluous air from the unit water circuit(s).
- 3 Close the nut.
- 4 Additional filling with water afterwards might be required (but never through the air purge valve).

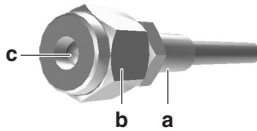

Fig. 4.6: Air purge valve

- a Air purge
- b Nut
- c Springy core

4.6. Connect the electrical wiring

Precautions

Observe the notes mentioned below when connecting the electrical wiring.

- Do not connect wires of different gauge to the same power supply terminal. Looseness in the connection may cause overheating.
- Do not connect wires of different gauge to the same grounding terminal. Looseness in the connection may deteriorate the protection.
- When connecting wires of the same gauge, connect them according to the figure "Terminal Wiring".



Fig. 4.7: Terminal wiring

- Use the specified electric wire (refer to "Field wiring specifications" on page 4). Connect the wire securely to the terminal. Lock the wire down without applying excessive force to the terminal. Use the appropriate tightening torque:

Tightening torque (N·m)	
Terminal block for remote controller	0.79~0.97
Terminal block for power supply	1.18~1.44

Table 4.1: Tightening torque

- Remote controller wiring should be located at least 50 mm away from the unit transmission wiring and other wiring. Failure to observe this guideline may result in malfunction due to electrical noise.
- For the remote controller wiring, refer to the installation manual of the remote controller delivered with the remote controller.
- Keep wiring in neat order so that wires do not obstruct other equipment or force the control box cover to pop open. Make sure the cover closes tight. Incomplete connections could result in overheating, and in the worst case, electric shock or fire.



Notice

Never connect the unit transmission wiring to the remote controller wiring. This connection could cause irreparable damage to the entire system.

Wiring diagram

Refer to the wiring diagram sticker on the unit (on the inside of the control box cover).

□□□□	: Terminal	RED	: Red	YLW	: Yellow
□□, □-	: Connector	BLK	: Black	GRN	: Green
::■□■□::	: Field wiring	WHT	: White	BLU	: Blue
		ORG	: Orange	BRN	: Brown
		GRY	: Grey	PNK	: Pink

A1P, A2P	Printed circuit board
C1	Capacitor
F1U	Fuse
HAP	Light emitting diode (service monitor green)
KPR	Magnetic relay (M1P)
L1	Coil
M1F	Motor (indoor fan)
M1P	Motor (drain pump)
M1S	Motor (swing flap)
PS	Power supply circuit
Q1D1	Earth leak detector
R1T	Thermistor (air)
R2T, R3T	Thermistor
S1L	Float switch
X1M, X2M	Terminal strip
Z1F	Ferrite core

Wired remote controller

R1T	Thermistor (air)
SS1	Selector switch (main/sub)

Wireless remote controller (Receiver/display unit)

A3P, A4P	Printed circuit board
BS1	Push button (ON/OFF)
H1P	Light emitting diode (ON - red)
H2P	Light emitting diode (timer - green)

H3P	Light emitting diode (filter sign - red)
H4P	Light emitting diode (defrost - orange)
SS1	Selector switch (main/sub)
SS2	Selector switch (wireless address set)

Connector for optional parts

X24A	Connector (wireless remote controller)
X33A	Connector (valve control adaptor)
X35A	Connector (external adaptor)

Notes

- 1 If a central remote controller is used, connect it to the unit in accordance with the controller installation manual.
- 2 X24A, X33A and X35A are connected when optional accessories are used.
- 3 Confirm the method of setting the selector switch (SS1, SS2) using the installation manual, engineering data, etc.
- 4 Availability of R2T and/or R3T is depending on model type.

System examples

- When using 1 remote controller for 1 indoor unit (normal operation) (See figure 12: "1 remote controller for 1 indoor unit")
 - a Fan coil unit
 - b Remote controller (optional equipment)
 - c Overcurrent fuse
- For group control or use with 2 remote controllers (See figure 13: "Group control or use with 2 remote controllers")
 - a Fan coil unit
 - b Remote controller (optional equipment)
 - c Overcurrent fuse
 - d Interconnection wiring: total current should not exceed 12 A.



Information

It is not necessary to designate indoor unit address when using group control. The address is automatically set when the power is activated.

- For forced OFF and ON/OFF operation, connect input wires from the outside to terminals T1 and T2 of the terminal board (remote controller to transmission wiring).

Wire specification	Sheathed vinyl cord or cable (2 wire)
Gauge	0.75-1.25 mm ²
Length	≤100 m
External terminal	Contact that can ensure the minimum applicable load of 15 V DC, 10 mA

Table 4.2: Forced OFF and ON/OFF wiring specifications

4.6.1. Connect the power supply

See figure 9: "How to connect electrical wiring".

- a Control box cover
- b Wiring diagram sticker
- c Power supply cable intake
- d Power supply terminal block – X2M
- e Power supply cable
- f Ground wire
- g Clamp
- h Remote controller and unit transmission cables intake
- i Remote controller cable
- j Unit transmission cable
- k Remote controller and unit transmission terminal block – X1M

- 1 Remove the control box cover (a) as illustrated in figure 9: "How to connect electrical wiring".
- 2 Pull the power supply cable (e) (or interconnection wiring in case of common power supply) inside through the power supply cable intake (c).
- 3 Strip the wires to the recommended length.
- 4 Connect the power supply wires to the power supply terminal block (d).
- 5 Connect the ground wire (f) to the grounding terminal.
- 6 Securely fix the wiring using a clamp (g).
- 7 Install an earth leakage detector and fuse in the power supply line (field supply). Select the earth leakage detector in accordance with the applicable legislation. To select the fuse, refer to "Electrical characteristics" on page 4.

4.6.2. Connect the remote controller and unit transmission wiring

- 1 Remove the control box cover (a) as illustrated in figure 9: "How to connect electrical wiring".
- 2 Pull the cables (i, j) inside through the remote controller and unit transmission cables intake (h).
- 3 Strip the wires to the recommended length.
- 4 Connect the remote controller wires to (P1, P2) terminals of the terminal block (k).
- 5 Connect the unit transmission wires to (F1, F2) terminals.
- 6 Securely fix the wiring using a clamp (g).

4.6.3. Close the control box

- 1 After all wiring connections are executed, fill gaps in the casing cable intakes with the small sealing pad (delivered with the unit) to prevent small animals, water or dirt from entering the unit causing short circuits in the control box.
- 2 Fit the control box cover (a) back in place like illustrated in figure 9: "How to connect electrical wiring". When attaching the control box cover, make sure not to pinch any wires.

4.7. Perform the drain piping work

4.7.1. Install the drain piping in the building

See figure 3: "Drain pipe installation".

- a Hanging bar
- b ≥1/100 gradient

Install the fan coil unit

- Keep piping as short as possible and slope it downwards at a gradient of at least 1/100 so that air does not remain trapped inside the pipe. Refer to “[Drain pipe installation](#)” on page 8. If the drain hose cannot be sufficiently set on a slope, fit the drain hose with a drain raising piping (field supply) as illustrated in figure 7: “How to perform drain piping”.
 - a Ceiling slab
 - b Hanger bracket
 - c Drain raising pipe (nominal diameter = 25 mm)
 - d Drain hose (delivered with the unit)
 - e Metal clamp (delivered with the unit)
- Keep pipe size equal to or greater than that of the connecting pipe (25 mm inner diameter).
- Install the drain raising pipes at a height of less than 675 mm.
- Install the drain raising pipes at a right angle to unit and no more than 300 mm from the unit.
- To prevent air bubbles, install the drain hose level or slightly tilted up (≤75 mm).
- Insulate the complete drain piping inside the building.



Information

When unifying multiple drain pipes, install the pipes as illustrated in figure 17: “Unifying multiple drain pipes”. Select converging drain pipes whose size is suitable for the operating capacity of the unit.

- a T-joint converging drain pipes

4.7.2. Connect the drain piping to the unit

- 1 Push the drain hose (delivered with the unit) as far as possible over the drain socket as illustrated in the figure below.

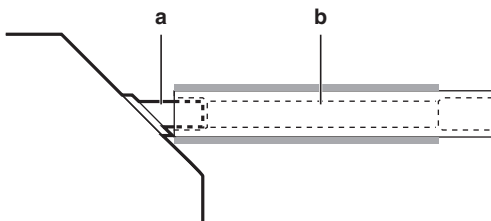

Fig. 4.8: Connecting the drain hose

- a Drain socket (fixed to the unit)
 - b Drain hose (delivered with the unit)
- 2 Tighten the metal clamp until the screw head is less than 4 mm from the metal clamp part as illustrated in figure 8: “Wrap sealing pad”.
 - a Drain socket (fixed to the unit)
 - b Drain hose (delivered with the unit)
 - c Metal clamp (delivered with the unit)
 - d Drain sealing pad (delivered with the unit)
 - e Large sealing pad (delivered with the unit)
 - f Drain piping (field supply)
 - 3 Wrap the large sealing pad (as illustrated in figure 8: “Wrap sealing pad”) over the metal clamp and drain hose and fix it with clamps.

4.7.3. Test the drain piping

After the drain piping work is finished, check if drainage flows smoothly.

- 1 Add approximately 1 l of water gradually through the air outlet (See figure 10: “Method of adding water”).
 - a Plastic watering can (tube should be about 100 mm long)
 - b Service drain outlet (with rubber plug) (Use this outlet to drain water from the drain pan)
 - c Drain pump location
 - d Drain pipe
 - e Drain socket
- 2 Check the drainage flow.

■ In case the electric wiring work is finished

Check drainage flow during COOL running, explained in “[Test the installation](#)” on page 11.

■ In case electric wiring work is not finished

- 1 Remove the control box cover. Connect the power supply (50 Hz, 220-240 V) to connections L and N on the power supply terminal block and connect the ground wire firmly.
- 2 Close the control box cover and turn on the power.



Danger: electric shock

Do not touch the drain pump.

- 3 Confirm the drain operation looking at the drain socket.
 - 4 After checking the drainage flow, turn off power, remove the control box cover and disconnect the power supply from the power supply terminal block again. Fit the control box cover back in place.
- 3 After the testing of drain piping is finished, attach the drain sealing pad (delivered with the unit) over the uncovered part of the drain socket (between drain hose (delivered with the unit) and unit body) as illustrated in figure 8: “Wrap sealing pad”.

4.8. Install optional equipment

For the installation of optional equipment, refer to the installation manual which is delivered with the optional equipment and take into account the remarks mentioned in the table below.

Option	Description	Remark
BYCQ140CW1	Decoration panel - standard	—
BYCQ140CW1W	Decoration panel - white	—
KAFP551K160	Long life replacement filter	—
KDDQ55C140	Fresh air intake kit	Installation: refer to FXFQ125P.
KDBHQ55C140	Sealing member of air discharge outlet	Settings: refer to type Y.
BRC7F532F	Remote controller - wireless (cooling and heating)	Not all functions are available for the FWC models.

Option	Description	Remark
BRC7F533F	Remote controller - wireless (cooling only)	Not all functions are available for the FWC models.
KRCS01-4	Remote temperature sensor	Installation: refer to VRV - FXFQ-P.
DCS302CA51	Central remote controller	Installation: direct connect to indoor unit, no outdoor unit connection. Not all functions are available for the FWC models.
DCS601C51C	Intelligent touch controller	Installation: direct connect to indoor unit, no outdoor unit connection. It is not possible to use AIRNET or telephone connection. Not all functions are available for the FWC models.
DCS301BA51	Unified ON/OFF controller	Installation: direct connect to indoor unit, no outdoor unit connection.
DST301BA51	Schedule timer	—
KRP4A(A)53	Wiring adaptor for electrical appendices	Installation: refer to FXF(Q). Connection: refer to VRV system.
KRP2A52	Wiring adaptor for electrical appendices	Installation: refer to FXF(Q). Connection: refer to VRV system.
KEK26-1A	Noise filter	—
KJB212AA	Electrical box with earth terminal (2 blocks)	—
KJB311A	Electrical box with earth terminal (3 blocks)	—
KJB411A	Electrical box	—
KRP1H98	Installation box for adaptor PCB	Installation: refer to VRV - FXFQ-P.
BRC315D7	Wired remote controller	—
EKMV2C09B7	2-way valve (ON/OFF type)	—
EKMV3C09B7	3-way valve (ON/OFF type)	—
EKRP1C11	Valve control PCB	Installation: do not use the installation manual delivered with the option EKRP1C11, but refer to the installation manual of options EKMV2 and EKMV3 instead.
EKFCMBCB7	Optional PCB for Modbus connection	—

Table 4.3: Installation of optional equipment

5 Commission the fan coil unit

5.1. Verify completion of installation

Danger: electric shock

See "Precautions for installation" on page 2.

After the installation of the unit, first check the following items. Once all below checks are fulfilled, the unit must be closed, only then can the unit be powered up.

Tick ✓	when checked
<input type="checkbox"/>	The unit is installed properly. If not installed properly, there may be abnormal noises and vibrations when starting up the unit.
<input type="checkbox"/>	The unit has been fully insulated. If not fully insulated, condensate water may drip.
<input type="checkbox"/>	The drainage flows smoothly. If drainage does not flow smoothly, condensate water may drip.
<input type="checkbox"/>	The power supply voltage corresponds to the voltage on the nameplate of the unit.
<input type="checkbox"/>	The wiring and piping connections are correct. In case of wrong connections, the unit may malfunction or components may burn out.
<input type="checkbox"/>	The earth wires are connected properly. The earth terminals have been tightened.
<input type="checkbox"/>	The wiring size is according to specifications. In case of wrong wiring size, the unit may malfunction or components may burn out.
<input type="checkbox"/>	The fuses, circuit breakers, or the locally installed protection devices are of the size and type specified in the chapter "Prepare the electrical wiring work" on page 4. None of the fuses or protection devices have been bypassed.
<input type="checkbox"/>	There are no visible loose connections or damaged electrical components in the control box or inside the unit.
<input type="checkbox"/>	There are no damaged components or squeezed pipes inside the unit.
<input type="checkbox"/>	There is no water leakage inside the unit. If there is water leakage, close the water inlet and water outlet shut-off valves and call your local DAIKIN dealer.
<input type="checkbox"/>	All air is removed from the circuit.
<input type="checkbox"/>	All options are correctly installed and connected.
<input type="checkbox"/>	The air inlet and outlet of the unit is not obstructed by paper sheets, cardboard, or any other material.

Table 5.1: Installation completion checklist

Warning

Be sure to provide for adequate measures in order to prevent that the unit will be used as a shelter by small animals. Small animals making contact with electrical parts can cause malfunctions, smoke or fire. Please instruct the user to keep the area around the unit clean and clear.

5.2. Configure the unit

It is important that all information in this chapter is read sequentially by the installer and that the unit is configured as applicable. Configuration of the unit is done through the controller in accordance with the installation condition.

- Setting can be made by changing the “Mode No.,” “First code No.” and “Second code No.”.
- For setting and operation, refer to “Field setting” in the installation manual of the controller.

Setting ceiling height

Adjust the Second code No. according to the table below so that it corresponds to the ceiling height of your installation. (Second code No. is factory set to “01”)

Ceiling height (m)	Mode No.	First code No.	Second code No.
≤3.2	13(23)	0	01
>3.2 or ≤3.6	13(23)	0	02
>3.6 or ≤4.2	13(23)	0	03

Table 5.2: Ceiling height setting

Setting air discharge direction

For changing air discharge direction (2, 3 or 4 directions), refer to the option handbook of the optional blocking pad kit. (Second code No. is factory set to “01” for all-round air discharge)

Setting air filter sign

Remote controllers are equipped with liquid crystal air filter signs to display the time to clean the air filter. Change the Second code No. Depending on the amount of dirt or dust in the room. (Second code No. is factory set to “01” for air filter contamination-light)

Setting	Display interval	Mode No.	First code No.	Second code No.
Light	±2500 hrs	10(20)	0	01
Heavy	±1250 hrs	10(20)	0	02
No display	—	10(20)	3	02

Table 5.3: Air filter contamination

When using wireless remote controllers it is necessary to use address setting. Refer to the controller installation manual for the setting instructions.

Activating forced OFF and ON/OFF operation

The following table explains “forced OFF” and “ON/OFF operations” in response to the input signal.

Forced OFF	ON/OFF operations	Protective equipment input
Input “ON” stops operation	Input OFF→ON: turns on the unit (impossible by remote controllers)	Input ON: enables abnormal system stop (an error code will be displayed)
Input “OFF” enables control	Input ON→OFF: turns off the unit (by remote controller)	Input OFF: enables normal operation

Table 5.4: Forced OFF and ON/OFF operation

- 1 Turn the power on and then use the remote controller to select operation.
- 2 Set the remote controller to the field set mode.

Setting	Mode No.	First code No.	Second code No.
Forced OFF	12(22)	8	01
ON/OFF operation	12(22)	8	02
Protective equipment input	12(22)	8	03

Table 5.5: Forced OFF and ON/OFF selection

5.3. Test the installation

After installation, the installer is obliged to verify correct operation. In case something is wrong with the unit and it does not operate, contact your local DAIKIN dealer.



Information

When using a wireless remote controller, conduct a test operation after installing the decoration panel.

Test operation before installing decoration panel



Danger: electric shock

See “Precautions for installation” on page 2.

- 1 Open the water inlet valve(s).
- 2 Open the water outlet valve(s).
- 3 Set to cooling operation with the remote controller and start operation by pushing **ON/OFF** button.
- 4 Press **Inspection/Test Operation** button 4 times and operate at **Test Operation** mode for 3 minutes.
- 5 Press **Inspection/Test Operation** button and operate normally.
- 6 Confirm function of unit according to the operation manual.
- 7 Turn off the main power supply after operation.

Test operation after installing decoration panel

- 1 Open the water inlet valve(s).
- 2 Open the water outlet valve(s).
- 3 Set to cooling operation with the remote controller and start operation by pushing **ON/OFF** button.
- 4 Press **Inspection/Test Operation** button 4 times (2 times for wireless remote controller) and operate at **Test Operation** mode for 3 minutes.
- 5 Push **air flow direction adjust** button to make sure the unit is in operation.
- 6 Press **Inspection/Test Operation** button and operate normally.
- 7 Confirm function of unit according to the operation manual.

5.4. Handover to the user

Once the test run is finished and the unit operates properly, fill in the sheet “Handover of the installation to the user” which is an annex of the user manual.

6 Service and maintenance

For safety reasons, switch off the unit before carrying out any maintenance or service activities. The service and maintenance activities which are mentioned in this paragraph may only be carried out by the installer or service company.



Danger: electric shock
See "Precautions for installation" on page 2.



Danger: high temperature
See "Precautions for installation" on page 2.



Notice
Do not pour any liquid on the fan coil unit. This could damage the components inside it.

6.1. Maintenance tasks

Cleaning the air filter

Clean the filter when necessary. Clean the filter at least once every 6 months. If the unit is installed in a room where the air is extremely contaminated clean more often.

If it becomes impossible to clean, replace the air filter with an original spare part.

To clean the air filter:

- 1 Switch off the power supply.
- 2 Push both knobs simultaneously and carefully lower the grill. The suction grill is now opened.
See figure 18: "Opening the suction grill"
- 3 Pull the hook of the air filter out diagonally downward and remove the filter.
See figure 20: "Detaching the air filter"
- 4 Use a vacuum cleaner or wash the air filter with water. When the air filter is very dirty, use a soft brush and neutral detergent.
See figure 22: "Cleaning the air filter"
- 5 Fix the air filter.
Attach the air filter to the suction grill by hanging it to the projected portion above the suction grill. Press the bottom of the air filter against the projections on the bottom of the grill to snap the air filter into its place.
See figure 23: "Fixing the air filter"
- 6 Close the suction grill.

Cleaning the suction grill

- 1 Switch off the power supply.
- 2 Push both knobs simultaneously and carefully lower the grill. The suction grill is now opened.
See figure 18: "Opening the suction grill"
- 3 Open the suction grill 45 degrees and lift it upward. The suction grill is now detached.
See figure 19: "Detaching the suction grill"
- 4 Pull the hook of the air filter out diagonally downward and remove the filter.
See figure 20: "Detaching the air filter"
- 5 Wash the suction grill with a soft brush and neutral detergent and dry thoroughly.
See figure 21: "Cleaning the suction grill"
- 6 Attach the air filter to the suction grill by hanging it to the projected portion above the suction grill. Press the bottom of the air filter against the projections on the bottom of the grill to snap the air filter into its place.
See figure 23: "Fixing the air filter"
- 7 Close the suction grill.

6.2. Service to the unit

For detailed instructions on reparations of the unit, refer to the service manual. Contact your local DAIKIN dealer to obtain the service manual.

If the cause of the problem can not be found or more information is needed, call your local DAIKIN dealer or the appointed service company.

In case some part is damaged and needs to be replaced, call your local DAIKIN dealer or the appointed service company for a list of available spare parts.



Information

Before starting the troubleshooting procedure, carry out a thorough visual inspection of the unit and look for obvious defects such as loose connections or defective wiring.

7 Glossary

Term	Meaning
Accessories:	Equipment which is delivered with the unit and which needs to be installed according to the instructions in the documentation
Applicable legislation:	All international, European, national and local directives, laws, regulations and/or codes which are relevant and applicable for a certain product or domain
Circuit breaker (fuse):	Safety device used in electrical installations to prevent electric shock
Dealer:	Sales distributor for fan coil units and other DAIKIN products
Field supply:	Equipment which needs to be installed according to instructions in this manual, but which are not supplied by DAIKIN
Installer:	Technical skilled person who is qualified to install fan coil units and other DAIKIN products
Service company:	Qualified company which can perform or coordinate the required service to the fan coil unit

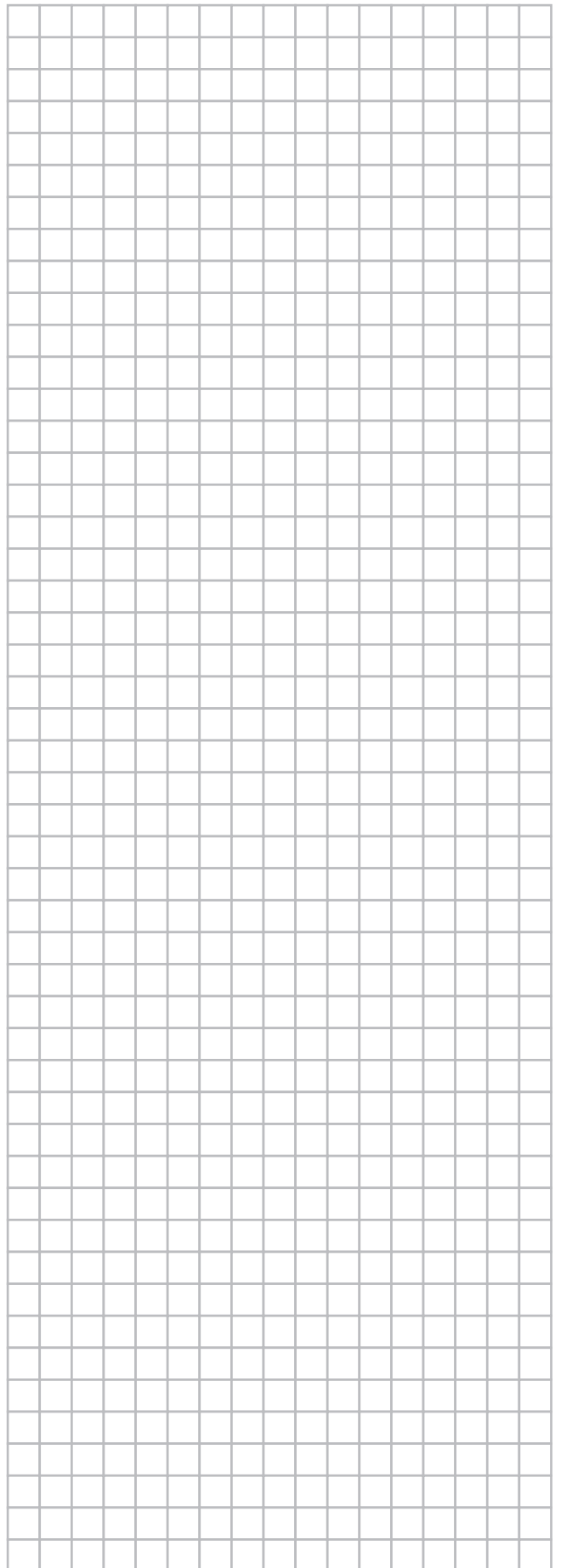
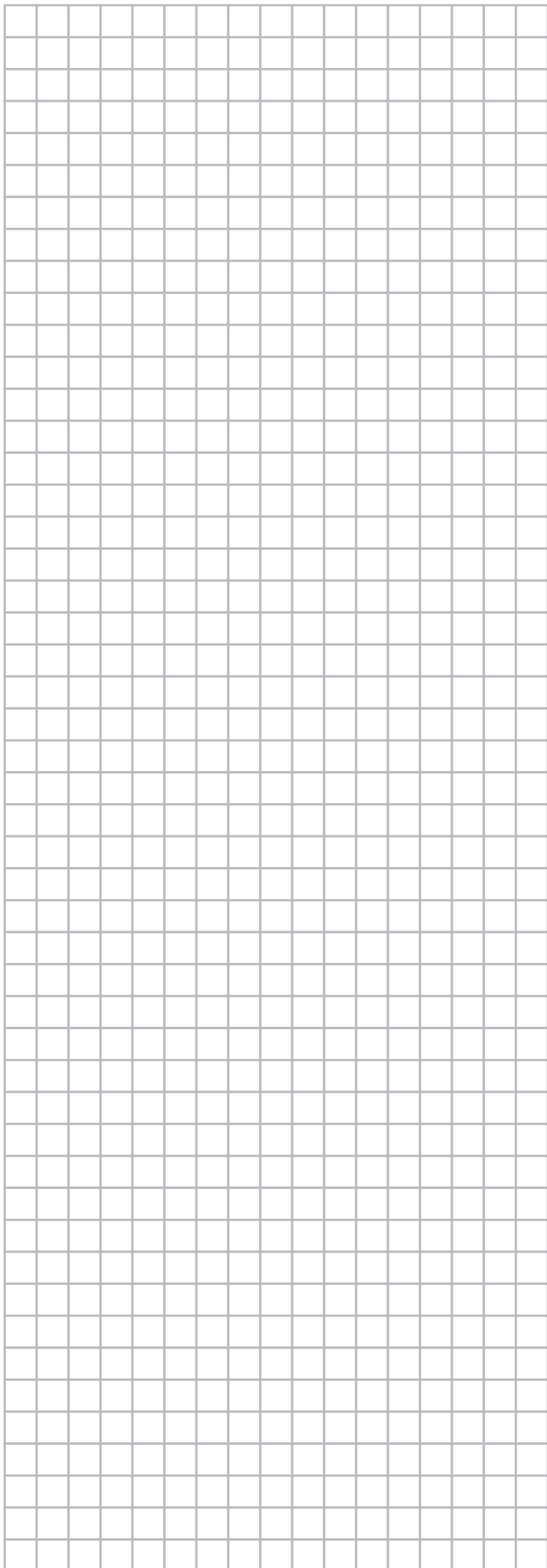

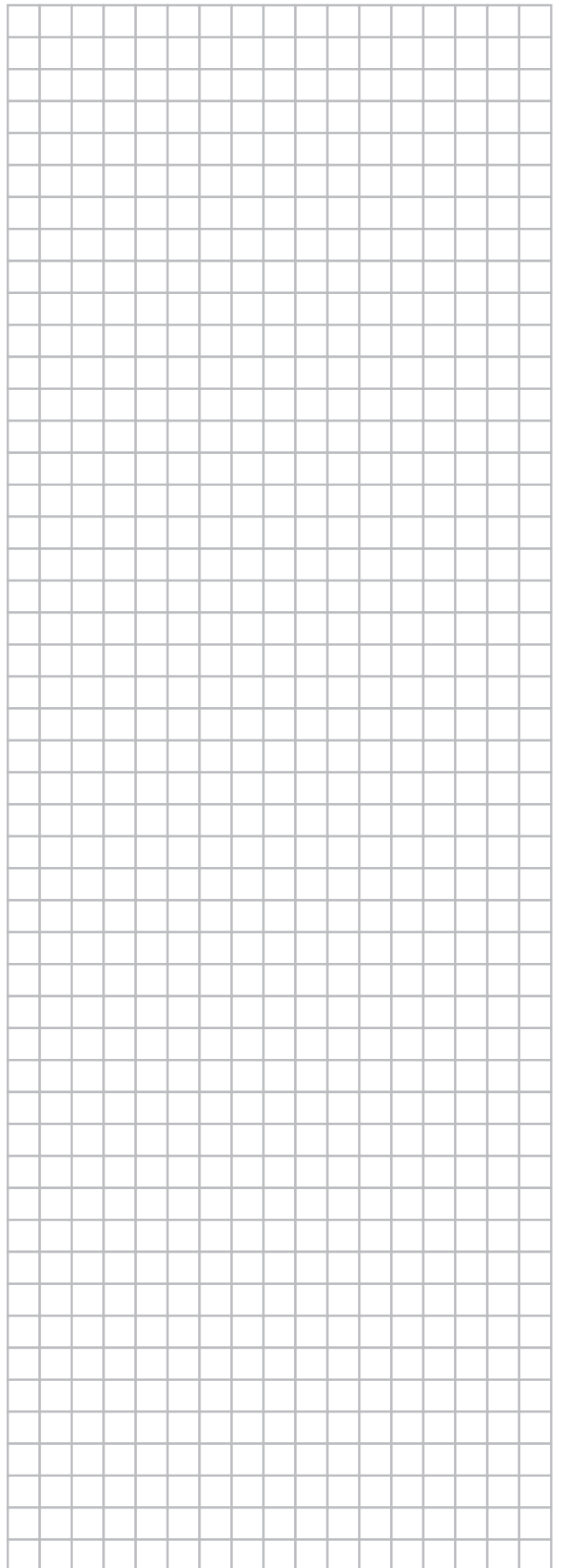
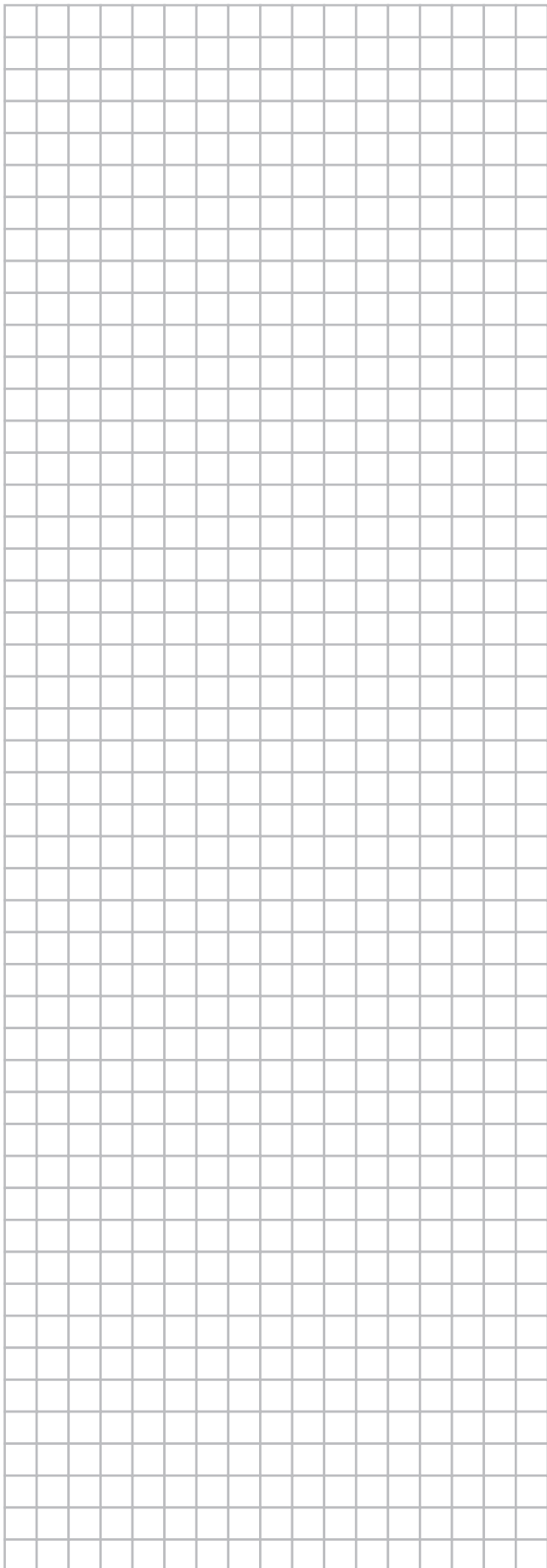

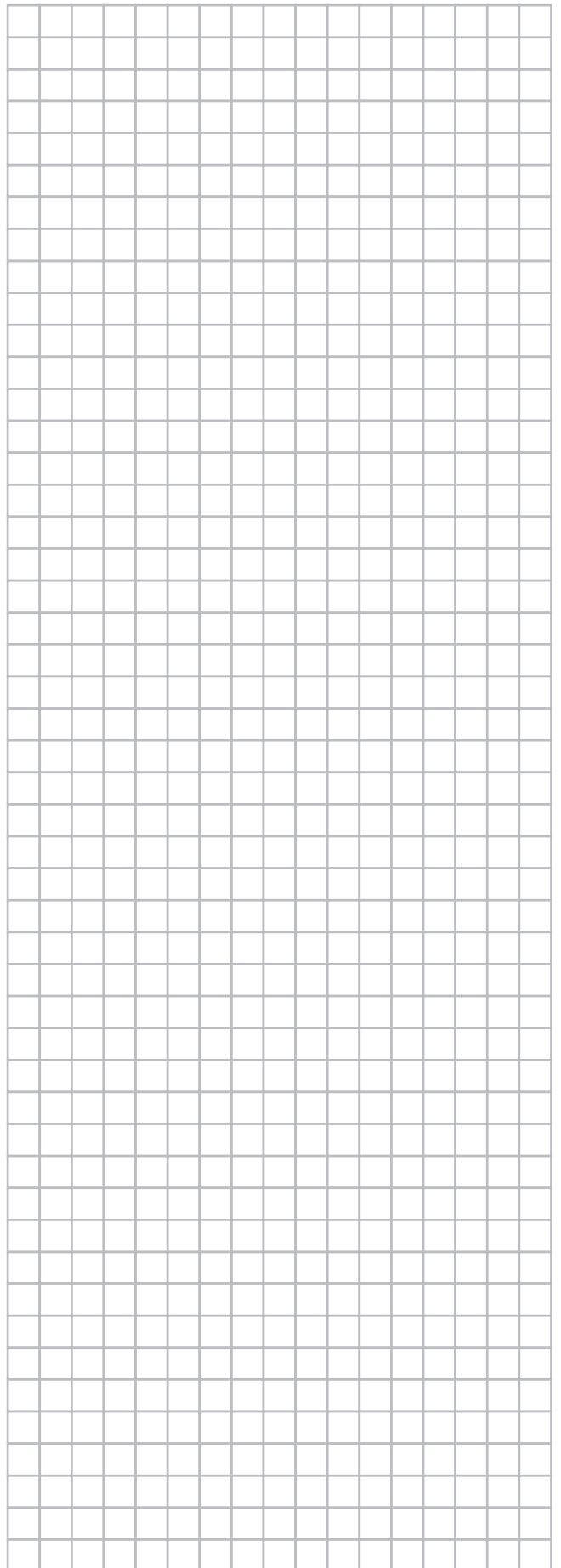
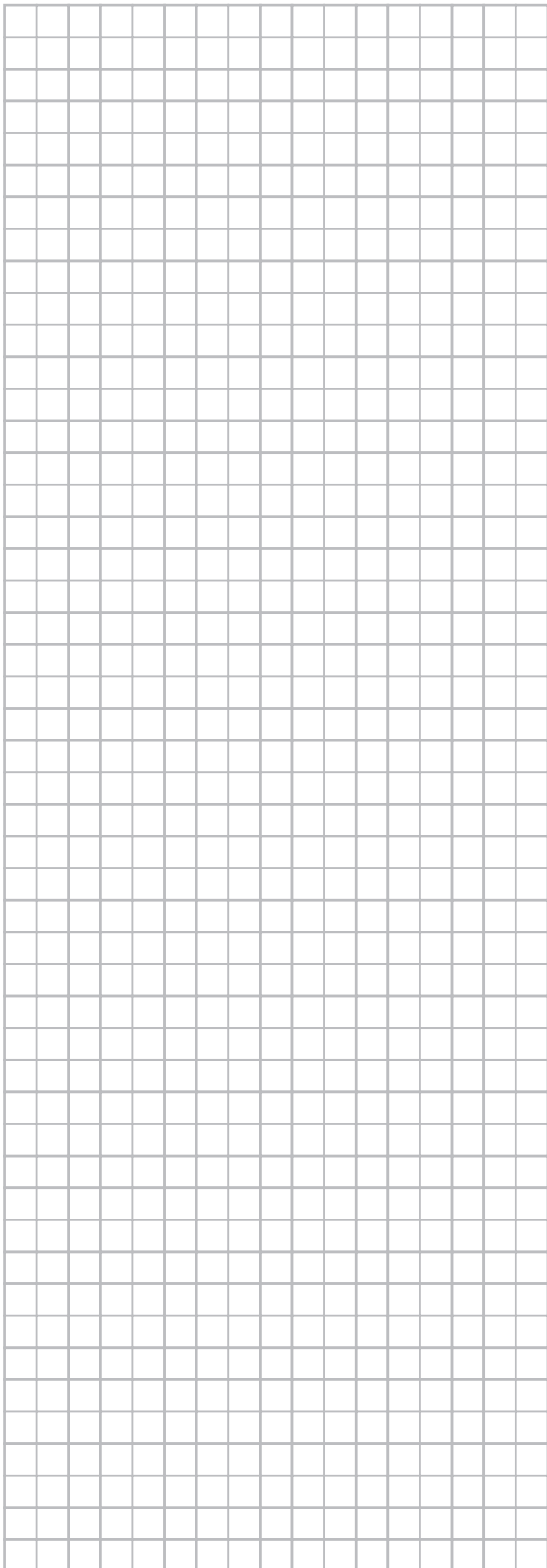

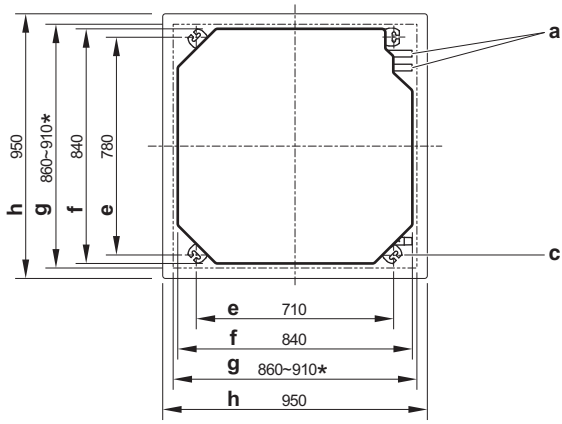

11

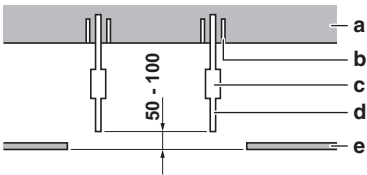
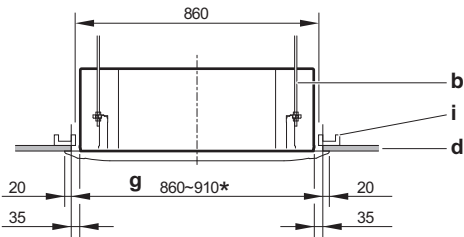

14

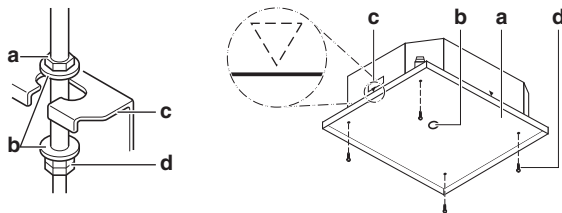

15

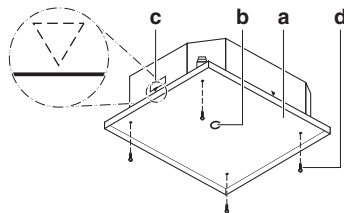

16

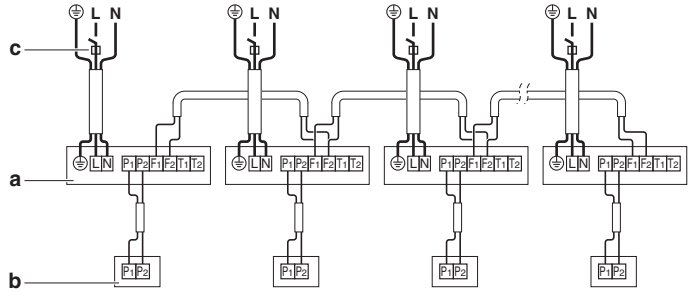

12

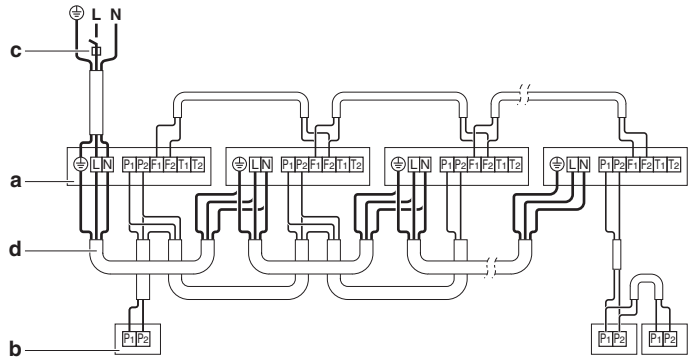

13

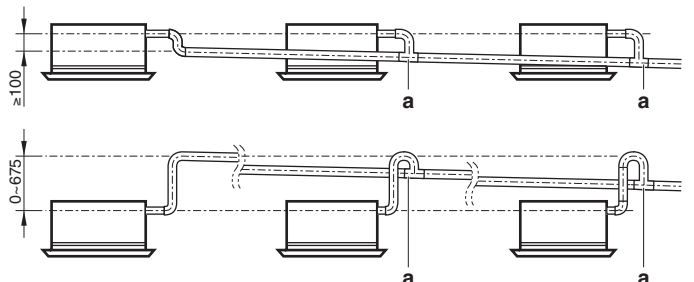

17

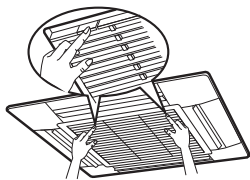

18

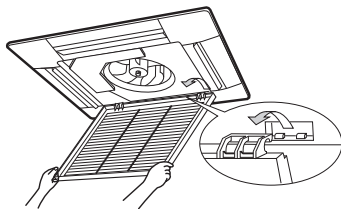

19

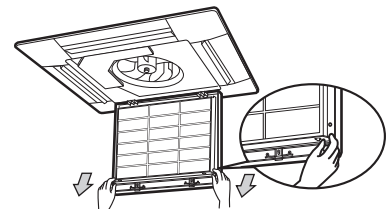

20



21



22

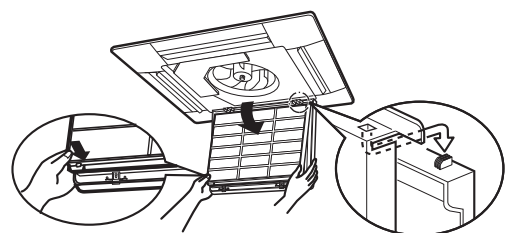

23



Copyright 2010 Daikin

DAIKIN EUROPE N.V.

Zandvoordestraat 300, B-8400 Oostende, Belgium

4PW64525-1B 2014.03