



REV	01
Date	May 2018
Supersedes	D-EOMZC00204-18_00EN

OPERATING MANUAL

EWYD4Z - Multipurpose Unit

D-EOMZC00204-18_01EN

TABLE OF CONTENTS

1 SAFETY CONSIDERATIONS 4

1.1 General.....4

1.2 Avoid electrocution.....4

1.3 Safety Devices.....4

2 GENERAL DESCRIPTION..... 5

2.1 Basic Information5

2.2 Abbreviations used5

2.3 Controller Operating Limits5

2.4 Controller Architecture5

2.5 Communication Modules.....6

3 USING THE CONTROLLER 7

3.1 General Recommendation7

3.2 Navigating.....7

3.3 Passwords8

3.4 Editing8

3.5 Basic Control System Diagnostic8

3.6 Controller maintenance.....9

3.7 Optional Remote User Interface.....9

3.8 Embedded Web Interface10

4 WORKING WITH THIS UNIT 12

4.1 Unit Setup.....12

4.1.1 Control Source12

4.1.2 Operating Mode.....12

4.1.3 Temperature Settings12

4.1.4 Pumps settings.....13

4.1.5 Alarm Settings.....13

4.1.6 Power Conservation13

4.1.6.1 Demand Limit13

4.1.6.2 Current Limit (Optional).....14

4.1.6.3 Setpoint Reset.....14

4.1.6.4 Setpoint Reset by OAT Reset14

4.1.6.5 Setpoint Reset by External 4-20 mA Signal15

4.1.6.6 Setpoint Reset by Evaporator Return Temperature15

4.1.7 Date/Time.....15

4.1.7.1 Date, Time and UTC Settings15

4.1.7.2 Quiet Mode Scheduling.....15

4.1.8 Scheduler15

4.2 Unit/Circuit Start-up.....15

4.2.1 Prepare the unit to start16

4.2.1.1 Unit Enable.....16

4.2.2 Unit Status.....16

4.2.3 Circuits Enable17

4.2.4 Circuit Status17

4.2.5 Circuit Preventions18

4.2.5.1 High Water Temperature Limit18

4.2.5.2 Low Evaporating Pressure18

4.2.5.3 High Condensing Pressure18

4.2.5.4 High Vfd Current19

4.2.5.5 High Discharge Temperature19

5 TROUBLESHOOTING 20

5.1 Unit Alerts.....20

5.1.1 Bad Current Limit Input20

5.1.2 Bad Demand Limit Input20

5.1.3 Bad Leaving Water Temperature Reset Input21

5.1.4 Condenser Pump #1 Failure21

5.1.5 Condenser Pump #2 Failure21

5.1.6 Energy Meter Communication Fail.....21

5.1.7 Evaporator Pump #1 Failure22

5.1.8 Evaporator Pump #2 Failure22

5.1.9 External Event22

5.1.10 Fan Alarm Module Communication Fail23

5.1.11 Heat Recovery Entering Water Temperature sensor fault23

5.1.12 Heat Recovery Leaving Water Temperature sensor fault23

5.1.13 Heat Recovery Water Temperatures inverted24

5.1.14	Rapid Recovery Module Communication Fail	24
5.1.15	Switch Box Temperature sensor fault	24
5.2	Unit Pumpdown Stop Alarms	25
5.2.1	Condenser Entering Water Temperature (EWT) sensor fault	25
5.2.2	Condenser Leaving Water Temperature (LWT) sensor fault	25
5.2.3	Evaporator Entering Water Temperature (EWT) sensor fault	25
5.2.4	Evaporator Water Temperatures inverted	26
5.2.5	Outside Air Temperature (OAT) Lockout	26
5.2.6	Outside Air Temperature sensor fault alarm	26
5.3	Unit Rapid Stop Alarms	26
5.3.1	Condenser Water Freeze alarm	26
5.3.2	Condenser Water Flow Loss alarm	27
5.3.3	Emergency Stop	27
5.3.4	Evaporator Flow Loss alarm	27
5.3.5	Evaporator Leaving Water Temperature (LWT) sensor fault	28
5.3.6	Evaporator Water Freeze alarm	28
5.3.7	External alarm	28
5.3.8	Gas Leakage Alarm	29
5.3.9	Heat Recovery Water Freeze Protect alarm	29
5.3.10	OptionCtrlrCommFail	29
5.3.11	Power Fault	29
5.3.12	PVM alarm	30
5.4	Circuit Alerts	30
5.4.1	Economizer Pressure Sensor fault	30
5.4.2	Economizer Temperature Sensor fault	31
5.4.3	Failed Pumpdown	31
5.4.4	Fan Fault	32
5.4.5	Gas Leakage Sensor fault	32
5.4.6	CxCmp1 MaintCode01	32
5.4.7	CxCmp1 MaintCode02	32
5.4.8	Power Loss	33
5.5	Circuit Pumpdown Stop Alarms	33
5.5.1	Discharge Temperature Sensor fault	33
5.5.2	Gas Leakage fault	33
5.5.3	High Compressor Vfd Temperature fault	34
5.5.4	Liquid Temperature Sensor fault	34
5.5.5	Low Compressor Vfd Temperature fault	34
5.5.6	Low Oil Level fault	35
5.5.7	Low Discharge Superheat fault	35
5.5.8	Oil Pressure Sensor fault	35
5.5.9	Suction Temperature Sensor fault	36
5.6	Circuit Rapid Stop Alarms	36
5.6.1	Compressor Extension Communication Error	36
5.6.2	EXV Driver Extension Communication Error	36
5.6.3	Compressor VFD Fault	37
5.6.4	Compressor VFD OverTemp	37
5.6.5	Condensing Pressure sensor fault	37
5.6.6	Economizer EXV Driver Error	38
5.6.7	Economizer EXV Motor Not Connected	38
5.6.8	Evaporating Pressure sensor fault	38
5.6.9	EXV Driver Error	39
5.6.10	EXV Motor Not Connected (TZ B, MP)	39
5.6.11	Fail Start Low Pressure	39
5.6.12	Fan VFD Over Current	39
5.6.13	High Discharge Temperature Alarm	40
5.6.14	High Motor Current Alarm	40
5.6.15	High Motor Temperature Alarm	41
5.6.16	High Oil Pressure Differential Alarm	41
5.6.17	High Pressure alarm	41
5.6.18	Low Pressure alarm	42
5.6.19	Low Pressure Ratio Alarm	42
5.6.20	Maximum Number of Restart Alarm	43
5.6.21	Mechanical High Pressure Alarm	43
5.6.22	Mechanical Low Pressure Alarm	44
5.6.23	No Pressure At Start Alarm	44
5.6.24	No Pressure Change At Start Alarm	44
5.6.25	Overvoltage Alarm	45
5.6.26	Undervoltage Alarm	45
5.6.27	VFD Communication Failure	46
6	OPTIONS	47
6.1	Energy Meter including Current Limit (Optional)	47

1 SAFETY CONSIDERATIONS

1.1 General

Installation, start-up and servicing of equipment can be hazardous if certain factors particular to the installation are not considered: operating pressures, presence of electrical components and voltages and the installation site (elevated plinths and built-up up structures). Only properly qualified installation engineers and highly qualified installers and technicians, fully trained for the product, are authorized to install and start-up the equipment safely.

During all servicing operations, all instructions and recommendations, which appear in the installation and service instructions for the product, as well as on tags and labels fixed to the equipment and components and accompanying parts supplied separately, must be read, understood and followed.

Apply all standard safety codes and practices.

Wear safety glasses and gloves.

Use the proper tools to move heavy objects. Move units carefully and set them down gently.

1.2 Avoid electrocution

Only personnel qualified in accordance with IEC (International Electrotechnical Commission) recommendations may be permitted access to electrical components. It is particularly recommended that all sources of electricity to the unit be shut off before any work is begun. Shut off main power supply at the main circuit breaker or isolator.

IMPORTANT: This equipment uses and emits electromagnetic signals. Tests have shown that the equipment conforms to all applicable codes with respect to electromagnetic compatibility.



RISK OF ELECTROCUTION: *Even when the main circuit breaker or isolator is switched off, certain circuits may still be energized, since they may be connected to a separate power source.*



RISK OF BURNS: *Electrical currents cause components to get hot either temporarily or permanently. Handle power cable, electrical cables and conduits, terminal box covers and motor frames with great care.*



ATTENTION: *In accordance with the operating conditions the fans can be cleaned periodically. A fan can start at any time, even if the unit has been shut down.*

1.3 Safety Devices

Each unit is equipped with safety devices of three different kinds:

- Emergency Stop
- Overcurrent/Overload Protections
- Overtemperature Protections
- Phase reversal, under/over voltage, ground fault protections
- Phase reversal, under/over voltage, ground fault protections
- Freezing protection
- High Pressure Protection
- Low Pressure Protection
- Mechanical High Pressure Switch
- Relief Safety Valve
- Inverter fault auto diagnostic



The emergency stop causes all motors to stop, but does not switch off power to the unit. Do not service or operate on the unit without having switched off the main switch.



Do not operate on a faulty fan before the main switch has been shut off. Overtemperature protection is auto-reset, therefore a fan may restart automatically if temperature conditions allow it.



Direct intervention on the power supply can cause electrocution, burns or even death. This action must be performed only by trained persons.

2 GENERAL DESCRIPTION

2.1 Basic Information

Microtech® III is a system for controlling single or dual-circuit air/water-cooled liquid chillers. Microtech® III controls compressor start-up necessary to maintain the desired heat exchanger leaving water temperature. In each unit mode it controls the operation of the condensers to maintain the proper condensation process in each circuit.

Safety devices are constantly monitored by Microtech® III to ensure their safe operation. Microtech® III also gives access to a Test routine covering all inputs and outputs. All Microtech® III controls can work in accordance with three independent modes:

- Local mode: the unit is controlled by commands from the user interface.
- Remote mode: the unit is controlled by remote contacts (voltage-free contacts).
- Network mode: the unit is controlled by commands from a BAS system. In this case, a data communication cable is used to connect the unit to the BAS.

When the Microtech® III system operates autonomously (Local or Remote mode) it retains all of its own control capabilities but does not offer any of the features of the Network mode. In this case monitoring of the unit operational data is still allowed.

2.2 Abbreviations used

In this manual, the refrigeration circuits are called circuit #1 and circuit #2. The compressor in circuit #1 is labelled Cmp1. The other in circuit #2 is labelled Cmp2. The following abbreviations are used:

A/C	Air Cooled
CEWT	Condenser Entering Water Temperature
CLWT	Condenser Leaving Water Temperature
CP	Condensing Pressure
CSRT	Condensing Saturated Refrigerant Temperature
DSH	Discharge Superheat
DT	Discharge Temperature
E/M	Energy Meter Module
EEWT	Evaporator Entering Water Temperature
ELWT	Evaporator Leaving Water Temperature
EP	Evaporating Pressure
ESRT	Evaporating Saturated Refrigerant Temperature
EXV	Electronic Expansion Valve
HMI	Human Machine Interface
MOP	Maximum operating pressure
SSH	Suction SuperHeat
ST	Suction Temperature
UC	Unit controller (Microtech III)
W/C	Water Cooled

2.3 Controller Operating Limits

Operation (IEC 721-3-3):

- Temperature -40...+70 °C
- Restriction LCD -20... +60 °C
- Restriction Process-Bus -25...+70 °C
- Humidity < 90 % r.h (no condensation)
- Air pressure min. 700 hPa, corresponding to max. 3,000 m above sea level

Transport (IEC 721-3-2):

- Temperature -40...+70 °C
- Humidity < 95 % r.h (no condensation)
- Air pressure min. 260 hPa, corresponding to max. 10,000 m above sea level.

2.4 Controller Architecture

The overall controller architecture is the following:

- One MicroTech III main controller
- I/O extensions as needed depending on the configuration of the unit
- Communications interface(s) as selected
- Peripheral Bus is used to connect I/O extensions to the main controller.

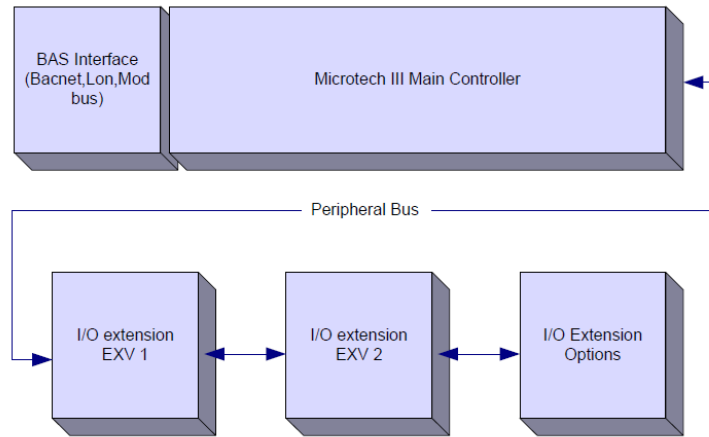

All boards are supplied from a common 24 Vac source. Extension boards can be directly powered by the Unit Controller. All boards can be also supplied by a 24Vdc source.



CAUTION: Maintain the correct polarity when connecting the power supply to the boards, otherwise the peripheral bus communication will not operate and the boards may be damaged.

2.5 Communication Modules

Any of the following modules can be connected directly to the left side of the main controller to allow a BAS or other remote interface to function. Up to three can be connected to the controller at a time. The controller should automatically detect and configure itself for new modules after booting up. Removing modules from the unit will require manually changing the configuration.

Module	Siemens Part Number	Usage
BacNet/IP	POL908.00/MCQ	Optional
Lon	POL906.00/MCQ	Optional
Modbus	POL902.00/MCQ	Optional
BACnet/MSTP	POL904.00/MCQ	Optional



3 USING THE CONTROLLER

The control system consists of a unit controller (UC) equipped with a set of extension modules that implement additional features. All boards communicate via an internal peripheral bus with the UC. The Microtech III continuously manages the information received from the various pressure and temperature probes installed on the compressors and communicated to the unit. The UC incorporates a program that controls the unit.

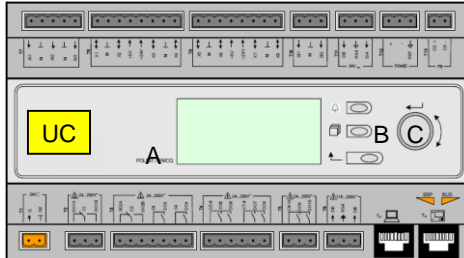
The standard HMI consists of an inbuilt display (A) with 3 buttons (B) and a push'n'roll control (C).



The keypad/display (A) consists of a 5-line by 22 character display. The function of the three buttons (B) is described below:

-  Alarm status (from any page it links with the page with alarm list, alarm log and alarm snapshot if available)
-  Back to Main Page
-  Back to the previous level (it can be the Main Page)

The push'n'roll command (C) is used to scroll between the different menu pages, settings and data available on the HMI for the active password level. Rotating the wheel allows to navigate between lines on a screen (page) and to increase and decrease changeable values when editing. Pushing the wheel acts as an Enter Button and will jump from a link to the next set of parameters.

3.1 General Recommendation

Before switching on the unit read the following recommendations:

- When all the operations and all the settings have been carried out, close all the switchbox panels
- The switchbox panels can only be opened by trained personnel
- When the UC requires to be accessed frequently the installation of a remote interface is strongly recommended
- Evaporator, compressors and related inverters are protected from freezing by electrical heaters. These heaters are supplied through unit main supply and temperature controlled by thermostat or by the unit controller. Also the LCD display of the unit controller may be damaged by extremely low temperatures. For this reason, it is strongly recommended to never power off the unit during winter, especially in cold climates.

3.2 Navigating

When power is applied to the control circuit, the controller screen will be active and display the Home screen, which can also be accessed by pressing the Menu Button. The navigating wheel is the only navigating device necessary, although the MENU, ALARM, and BACK buttons can provide shortcuts as explained previously.

An example of the HMI screens is shown in the following picture.

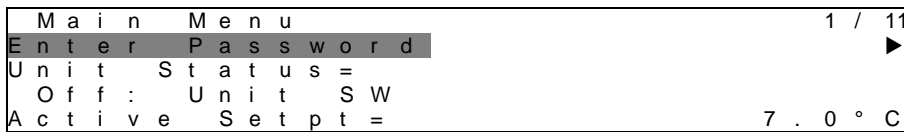

A bell ringing in the top right corner will indicate an active alarm. If the bell doesn't move it means that the alarm has been acknowledged but not cleared because the alarm condition hasn't been removed. A LED will also indicate where the alarm is located between the unit or circuits.

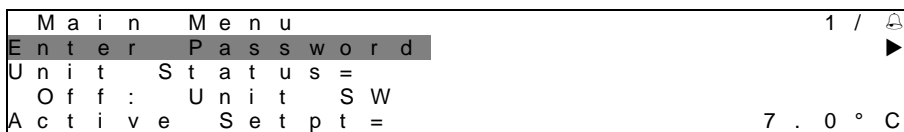

The active item is highlighted in contrast, in this example the item highlighted in Main Menu is a link to another page. By pressing the push'n'roll, the HMI will jump to a different page. In this case the HMI will jump to the Enter Password page.

E n t e r P a s s w o r d	2 / 2
E n t e r P W	* * * *

3.3 Passwords

The HMI structure is based on access levels that means that each password will disclose all the settings and parameters allowed to that password level. Basic informations about the status including the active alarm list, active setpoint and controlled water temperature can be accessed without the need to enter the password. The user UC handles two level of passwords:

USER	5321
MAINTENANCE	2526

The following information will cover all data and settings accessible with the maintenance password. User password will disclose a subset of the settings explained in chapter **Errore. L'origine riferimento non è stata trovata..**

In the Enter Password screen, the line with the password field will be highlighted to indicate that the field on the right can be changed. This represents a setpoint for the controller. Pressing the push'n'roll the individual field will be highlighted to allow an easy introduction of the numeric password. By changing all fields, the 4 digits password will be entered and, if correct, the additional settings available with that password level will be disclosed.

E n t e r P a s s w o r d	2 / 2
E n t e r P W	5 * * *

The password will time out after 10 minutes and is cancelled if a new password is entered or the control powers down. Entering an invalid password has the same effect as continuing without a password.

Once a valid password has been entered, the controller allows further changes and access without requiring the user to enter a password until either the password timer expires or a different password is entered. The default value for this password timer is 10 minutes. It is changeable from 3 to 30 minutes via the Timer Settings menu in the Extended Menus.

3.4 Editing

The Editing Mode is entered by pressing the navigation wheel while the cursor is pointing to a line containing an editable field. Once in the edit mode pressing the wheel again causes the editable field to be highlighted. Turning the wheel clockwise while the editable field is highlighted causes the value to be increased. Turning the wheel counter-clockwise while the editable field is highlighted causes the value to be decreased. The faster the wheel is turned, the faster the value is increased or decreased. Pressing the wheel again cause the new value to be saved and the keypad/display to leave the edit mode and return to the navigation mode.

A parameter with an "R" is read only; it is giving a value or description of a condition. An "R/W indicates a read and/or write opportunity; a value can be read or changed (providing the proper password has been entered).

3.5 Basic Control System Diagnostic

MicroTech III controller, extension modules and communication modules are equipped with two status LED (BSP and BUS) to indicate the operational status of the devices. The BUS LED indicates the status of the communication with the controller. The meaning of the two status LED is indicated below.

Main Controller (UC)

BSP LED	Mode
Solid Green	Application running
Solid Yellow	Application loaded but not running (*) or BSP Upgrade mode active
Solid Red	Hardware Error (*)
Flashing Green	BSP startup phase. The controller needs time for starting.
Flashing Yellow	Application not loaded (*)
Flashing Yellow/Red	Fail safe mode (in case that the BSP upgrade was interrupted)
Flashing Red	BSP Error (software error*)
Flashing Red/Green	Application/BSP update or inzialization

(*) Contact Service.

Extension modules

BSP LED	Mode	BUS LED	Mode
Solid Green	BSP running	Solid Green	Communication running, I/O working
Solid Red	Hardware Error (*)	Solid Red	Communication down (*)

Flashing Red	BSP Error (*)	Solid Yellow	Communication running but parameter from the application wrong or missing, or incorrect factory calibration
Flashing Red/Green	BSP upgrade mode		

Communication modules

BSP LED (same for all modules)

BSP LED	Mode
Solid Green	BPS running, communication with controller
Solid Yellow	BSP running, no communication with controller (*)
Solid Red	Hardware Error (*)
Flashing Red	BSP Error (*)
Flashing Red/Green	Application/BSP update

(*) Contact Service.

BUS LED

BUS LED	LON	Bacnet MSTP	Bacnet IP	Modbus
Solid Green	Ready for Communication. (All Parameter loaded, Neuron configured). Doesn't indicate a communication with other devices.	Ready for Communication. The BACnet Server is started. It doesn't indicate an active communication	Ready for Communication. The BACnet Server is started. It doesn't indicate an active communication	All Communication running
Solid Yellow	Startup	Startup	Startup. The LED stays yellow until the module receives a IP Address, therefore a link must be established.	Startup, or one configured channel not communicating to the Master
Solid Red	No Communication to Neuron (internal error, could be solved by downloading a new LON application)	BACnet Server down. Automatically a restart after 3 seconds are initiated.	BACnet Server down. Automatic restart after 3 seconds is initiated.	All configured Communications down. Means no communication to the Master. The timeout can be configured. In case that the timeout is zero the timeout is disabled.
Flashing Yellow	Communication not possible to the Neuron. The Neuron must be configured and set online over the LON Tool.			

3.6 Controller maintenance

The controller requires to maintain the installed battery. Every two years it's required to replace the battery. Battery model is: BR2032 and it is produced by many different vendors.

To replace the battery remove the plastic cover of the controller display using a screw driver as shown in the following pictures:



Be careful to avoid damages to the plastic cover. The new battery shall be placed in the proper battery holder which is highlighted in the picture, respecting the polarities indicated into the holder itself.

3.7 Optional Remote User Interface

As an option an external Remote HMI can be connected on the UC. The Remote HMI offers the same features as the inbuilt display plus the alarm indication done with a light emitting diode located below the bell button.

The Remote can be ordered with the unit and shipped loose as a field installed option. It can also be ordered any time after chiller shipment and mounted and wired on the job as explained on the following page. The remote panel is powered from the unit and no additional power supply is required.

All viewing and setpoint adjustments available on the unit controller are available on the remote panel. Navigation is identical to the unit controller as described in this manual.

The initial screen when the remote is turned on shows the units connected to it. Highlight the desired unit and press the wheel to access it. The remote will automatically show the units attached to it, no initial entry is required.

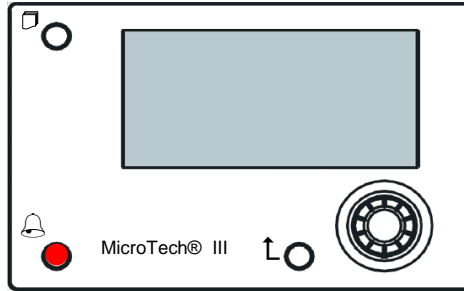

The Remote HMI can be extended up to 700m using the process bus connection available on the UC. With a daisy-chain connection as below, a single HMI can be connected to up to 8 units. Refer to the specific HMI manual for details.

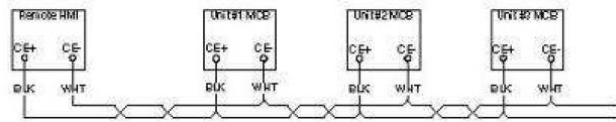

3.8 Embedded Web Interface

The MicroTech III controller has an embedded web interface that can be used to monitor the unit when connected to a local network. It is possible to configure the IP addressing of the MicroTech III as a fixed IP or DHCP depending on the network configuration.

With a common web browser a PC can connect with the unit controller entering the IP address of the controller or the host name, both visible in the “About Chiller” page accessible without entering a password.

When connected, it will be required to enter a user name and a password. Enter the following credential to get access to the web interface:

User Name: ADMIN
 Password: SBTAdmin!

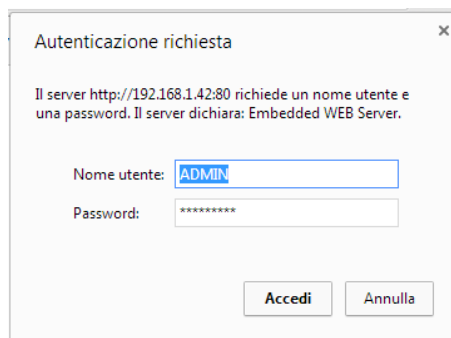

The Main Menu page will be displayed. The page is a copy of the onboard HMI and follows the same rules in terms of access levels and structure.

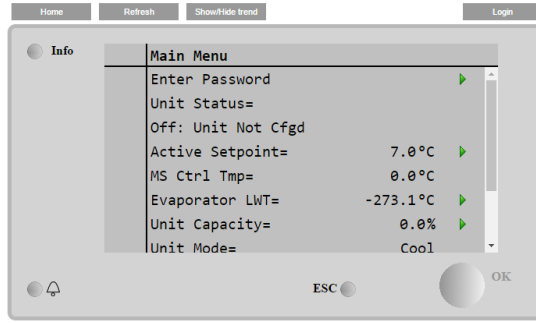

In addition it allows to trend log a maximum of 5 different quantities. It's required to click on the value of the quantity to monitor and the following additional screen will become visible:

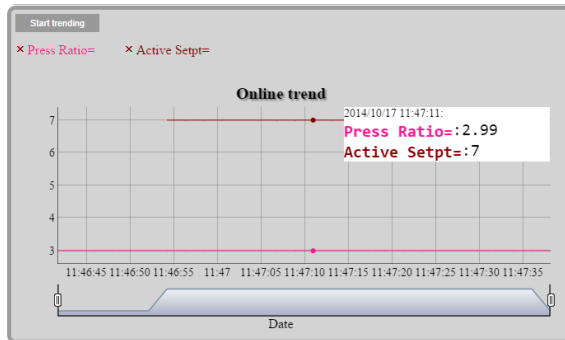

Depending on the web browser and its version the trend log feature may not be visible. It's required a web browser supporting HTML 5 like for example:

- Microsoft Internet Explorer v.11,
- Google Chrome v.37,
- Mozilla Firefox v.32.

These software are only an example of the browser supported and the versions indicated have to be intended as minimum versions.

4 WORKING WITH THIS UNIT

This section contains a guide on how to deal with the everyday usage of the unit. Next sections describe how to perform routine tasks on the unit, such as:

- Unit Setup
- Unit/Circuit start-up
- Alarm handling
- BMS Control
- Battery replacement

4.1 Unit Setup

Before starting up the unit, some basic settings need to be set by the customer according to the application.

- Control Source
- Available Modes
- Temperature Settings
- Alarm Settings
- Pump Settings
- Power Conservation
- Date/Time
- Scheduler

4.1.1 Control Source

This function allows to select which source should be used for unit control. The following sources are available:

- Local Unit is enabled by local switches placed into the switchbox, chiller mode (cool, cool w/glycol, ice), LWT setpoint and capacity limit are determined by local settings in the HMI.
- Network Unit is enable by a remote switch, chiller mode, LWT setpoint and capacity limit are determined by an external BMS. This function requires:
Remote enable connection to a BMS (unit on/off switch must be in remote)
Communication module and its connection to a BMS.

4.1.2 Operating Mode

The following operating modes can be selected through the Available modes setpoint.

Mode	Description
Cool	Set if only chilled water temperature up to 4°C is required. No glycol is generally needed in the water circuit, unless ambient temperature may reach low values.
Cool w/Glycol	Set if only chilled water temperature below 4°C is required. This operation requires proper glycol/water mixture in the evaporator water circuit.
Cool/Ice w/Glycol	Set in case only a dual cool/ice mode is required. This setting implies an operation with double setpoint which is activated through a customer supplied switch, according to the following logic: Switch OFF: The chiller will work in cooling mode with the Cool LWT 1 being as the Active Setpoint. Switch ON: The chiller will work in ice mode with the Ice LWT as the Active Setpoint.
Ice w/Glycol	Set if only ice storage is required. The application requires the compressors to operate at full load until the ice bank is completed, and then to stop for at least 12 hours. In this mode the compressor(s) will not operate at part load, but will work only in on/off mode.
MultiPurpose	Set in case a contemporary cool/heat mode is required. This setting implies an operation with double functioning, <ul style="list-style-type: none"> • with the Cool LWT 1 as the cooling Active Setpoint and • with the Heat LWT 1 as the heating Active Setpoint.
MultiPurpose w/Glycol	Set in case a contemporary cool/heat mode is required. This setting implies an operation with double functioning, <ul style="list-style-type: none"> • with the Cool LWT 1 as the cooling Active Setpoint and • with the Heat LWT 1 as the heating Active Setpoint.
MultiPurpose/Ice w/Glycol	Set in case a contemporary cool/heat mode is required. This setting implies an operation with double functioning, <ul style="list-style-type: none"> • with the Ice LWT as the cooling Active Setpoint and • with the Heat LWT 1 as the heating Active Setpoint.
Test	Enables the Manual Control of the unit. The manual test feature helps in debugging and checking the operational status of sensors and actuators. This feature is accessible only with the maintenance password in the main menu. To activate the test feature is required to disable the Unit from the Q0 switch and change the available mode to Test (see section 4.2.1).

4.1.3 Temperature Settings

Setpoint range is limited according to the selected operating mode. The controller includes:

- two set points in cooling mode (either standard cool or cool w/glycol)
- two set points in heating mode
- one set point in ice mode

The above setpoints are activated according to Operating mode, Double Setpoint or Scheduler selection. If the Time Scheduler is enabled the Double Setpoint input state will be ignored by the controller.

The table below lists the LWT Setpoint being activated according to the operation mode, the double setpoint switch status and the scheduler state. The table also reports the defaults and the range allowed for each setpoint.

Operating Mode	Double Input	Setpoint	Scheduler	LWT Setpoint	Default	Range
Cool	OFF		Off, On Setpoint 1	Cool LWT 1	7.0°C	4.0°C ÷ 15.0°C
	ON		On Setpoint 2	Cool LWT 2	7.0°C	4.0°C ÷ 15.0°C
Ice	N/A		N/A	Ice LWT	-4.0°C	-8.0°C ÷ 4.0°C
Heat	OFF		Off, On Setpoint 1	Heat LWT 1	45.0°C	30.0°C ÷ 60.0°C(*)
	ON		On Setpoint 2	Heat LWT 2	45.0°C	30.0°C ÷ 60.0°C(*)

(*) 30.0°C ÷ 65.0 for HT unit type

The LWT setpoint can be overridden in case the setpoint reset or the quiet mode are activated.

4.1.4 Pumps settings

The UC can manages one or two water pumps for both evaporator and, for W/C units, condenser. Number of pumps and their priority can be set from the HMI. The following options are available to control the pump(s):

- #1 Only Set to this in case of single pump or twin pump with only #1 operational (f.e. in case of maintenance on #2)
- #2 Only Set to this in case of twin pump with only #2 operational (f.e. in case of maintenance on #1)
- Auto Set for automatic pump start management. At each chiller start, the pump with the least number of hours will be activated.
- #1 Primary Set to this in case of twin pump with #1 running and #2 as a backup
- #2 Primary Set to this in case of twin pump with #2 running and #1 as a backup

4.1.5 Alarm Settings

If glycol is present in the water circuits, factory defaults values for the Alarm Limits listed below must be adjusted:

Parameter	Description
Low Press Hold	Set the minimum refrigerant pressure of the unit. It is generally recommended to set to a value whose saturated temperature is 8 to 10°C below the minimum active setpoint. This will allow a safe operation and a proper control of compressor suction superheat.
Low Press Unload	Set lower than the hold threshold enough to allow a suction pressure recovery from fast transients without unloading the compressor. A 20 kPa differential is generally appropriate for most applications.
Evap Water Frz	Stops the unit in case the leaving temperature falls below a given threshold. To allow a safe operation of the chiller, this setting must be adequate to the minimum temperature allowed by the mixture water/glycol present in the evaporator water circuit.
Cond Water Frz	Stops the unit in case the leaving temperature falls below a given threshold. To allow a safe operation of the chiller, this setting must be adequate to the minimum temperature allowed by the mixture water/glycol present in the condenser water circuit.



When glycol is used in the plant, always disconnect antifreeze electric heater.

4.1.6 Power Conservation

4.1.6.1 Demand Limit

Demand limit function allows the unit to be limited to a specified maximum load. Capacity limit level is defined with an external 4-20 mA signal and linear relationship. 4 mA indicate maximum capacity available whereas 20 mA indicates minimum capacity available.

With demand limit function is not possible shutdown the unit but only unload it until minimum admissible capacity. Demand limit related setpoints available through this menu are listed in the table below.

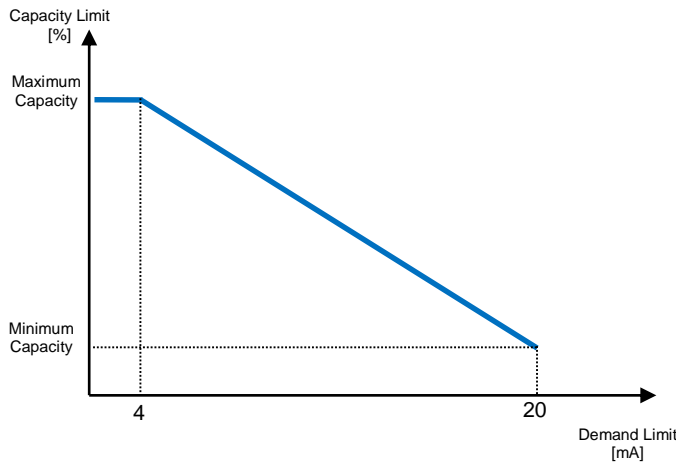

Parameter	Description
Unit Capacity	Displays current unit capacity
Demand Limit En	Enables demand limit
Demand Limit	Displays active demand limit

4.1.6.2 Current Limit (Optional)

Current limit function allows to control unit power consumption taking current drawn below a specific limit. Starting from the Current Limit Setpoint defined through the HMI or BAS communication, user can decrease the real limit using an external 4-20mA signal as indicate in the graph below. With 20 mA real current limit is set to Current Limit Setpoint, whereas with 4 mA signal the unit is unloaded until minimum capacity.

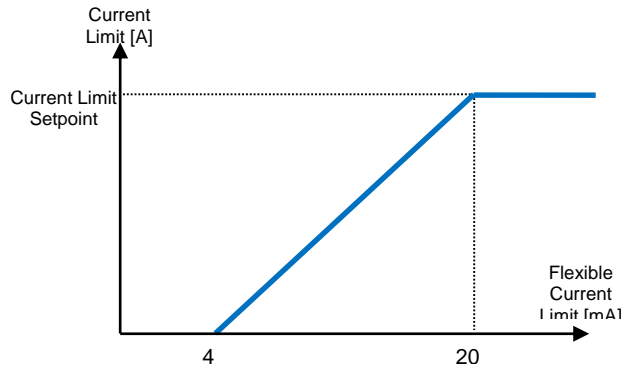

4.1.6.3 Setpoint Reset

The setpoint reset function overrides the water temperature setpoints selected through the interface, when certain circumstances occur. This feature helps in reducing energy consumption optimizing comfort as well. Three different control strategies can be selected:

- Setpoint Reset by Outside Air Temperature (OAT)
- Setpoint Reset by an external signal (4-20mA)
- Setpoint Reset by Evaporator ΔT (Return)

The following setpoints are available through this menu:

Parameter	Description
Setpoint Reset	Set the Setpoint Reset mode (None, 4-20 mA, Return, OAT)
Max Reset	Max Setpoint Reset (valid for all active modes)
Start Reset DT	Used on Setpoint Reset by Evaporator DT
Max Reset OAT	See Setpoint Reset by OAT Reset
Strt Reset OAT	See Setpoint Reset by OAT Reset

4.1.6.4 Setpoint Reset by OAT Reset

The active setpoint is calculated applying a correction which is a function of ambient temperature (OAT). As temperature drops below the Start Reset OAT (SROAT), Cool LWT setpoint is gradually increased until OAT reaches the Max Reset OAT value (MROAT). Beyond this value, the Cool LWT setpoint is increased by the Max Reset (MR) value. As temperature grow over the Start Reset OAT (SROAT), Heat LWT setpoint is gradually reduced until OAT reaches the Max Reset OAT value (MROAT). Above this value, the Heat LWT setpoint is decreased by the Max Reset (MR) value.

4.1.6.5 Setpoint Reset by External 4-20 mA Signal

The active setpoint is calculated applying a correction based on an external 4-20mA signal. 4 mA corresponds to 0°C correction, while 20 mA corresponds to a correction of the active setpoints as set in Max Reset (MR).

4.1.6.6 Setpoint Reset by Evaporator Return Temperature

The active cooling setpoint is calculated applying a correction that depends on the evaporator entering (return) water temperature. The active heating setpoint is calculated applying a correction that depends on the condenser entering (return) water temperature.



The Return Reset may affect negatively the chiller operation when operated with variable flow. Avoid to use this strategy in case of inverter water flow control.

4.1.7 Date/Time

4.1.7.1 Date, Time and UTC Settings

Date, time and UTC settings are available in the HMI.

4.1.7.2 Quiet Mode Scheduling

The Quiet Mode can be used to reduce chiller noise in certain hours of the day when noise reduction is more important than cooling operation, like for example in night time. When Quiet Mode is activated, the LWT setpoint is increased by the maximum setpoint reset (MR) described in the chapter “Setpoint Reset”, thus forcing a capacity limitation to the unit without losing control on chilled water temperature. Also, condenser temperature target is increased by a value set in “QM Cond Offset”. In this way condenser fans are forced to reduce speed without losing control on condensation. Quiet mode is timer enabled.



The Quiet Mode may affect negatively chiller efficiency due to the increased condenser setpoint

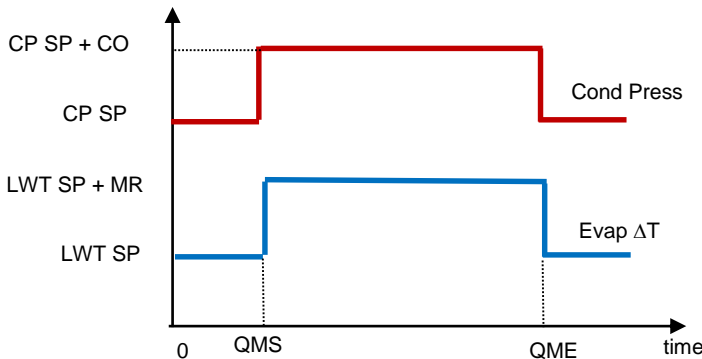

Parameter	Default	Range
Quiet Mode	Disable	Disable, Enable
QM Start Hr (QMS)	21h	0...24h
QM Start Min	0min	0...60min
QM End Hr (QME)	6h	0...24h
QM End Min	0min	0...60min
QM Cond Offset (CO)	5°C	0...10°C

4.1.8 Scheduler

Unit On/Off can be managed automatically through the function Time Scheduler enabled when the parameter Unit Enable is set to Scheduler. **Errore. L'origine riferimento non è stata trovata.** For each day of the week user can define six time slots and choose for each time slot one of following mode:

Parameter	Description
Off	Unit Off
On Setpoint 1	Unit On and Cool LWT 1 is the active setpoint
On Setpoint 2	Unit On and Cool LWT 2 is the active setpoint

4.2 Unit/Circuit Start-up

In this section, starting and stopping sequence of the unit will be described. status will be briefly described to allow a better understanding of what is going on into the chiller control.

4.2.1 Prepare the unit to start

4.2.1.1 Unit Enable



The unit starts only if all the enable setpoints/signals are active:

- Unit Switch Enable (signal) = Enable
- Keypad Enable (setpoint) = Enable
- BMS Enable (setpoint) = Enable

Switch Enable		Software Enable		BMS Enable	Unit Status
Q0	State	Chiller Enable (KeyPad Enable set point)	Control Source (set point)	BAS request	
0	X	X	X	X	DISABLED
LOCAL	X	Disable	X	X	DISABLED
LOCAL	X	X	Network	DISABLE	DISABLED
LOCAL	X	Enable	Local	X	ENABLED
LOCAL	X	Enable	Network	ENABLE	ENABLED
REMOTE	Open	X	X	X	DISABLED
REMOTE	X	Disable	X	X	DISABLED
REMOTE	Closed	Enable	Network	DISABLE	DISABLED
REMOTE	Closed	Enable	Local	X	ENABLED
REMOTE	Closed	Enable	Network	ENABLE	ENABLED

Switch Enable

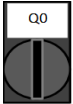
Each unit is equipped with a Main selector installed outside the front panel of the unit switchbox. As shown in the pictures below, for TZ and TZ B units three different positions can be selected: Local, Disable, Remote:

	Local	<i>With the Q0 switch in this position the unit is enabled. Pump will start if all other enable signals are set to enable and at least one compressor is available to run</i>
	Disable	<i>With the Q0 switch in this position the unit is disabled. Pump will not start in normal operational condition. Compressor are kept disabled independently from the status of the individual enable switches.</i>
	Remote	<i>With the Q0 switch in this position the unit can be enabled using the additional connections available on the connection terminals. A closed loop will identify an enable signal, this can come from a remote switch or a timer by example.</i>

Keypad Enable

The Keypad enable setpoint is not accessible by user password level. If it is set to “Disable”, contact your local maintenance service to check if it can be changed to Enable.

BMS Enable

The last enable signal is coming through the high level interface, that is from a Building Management System. The unit can be enabled/disabled from a BMS connected to the UC using a communication protocol. In order to control the unit over the network, the Control Source setpoint must be turned in “Network” (default is Local) and Network En Sp must be “Enable”(Errore. L'origine riferimento non è stata trovata.). If disabled, check with your BAS company how the chiller is operated.

4.2.2 Unit Status

One of the texts strings listed in the table below will inform, on the HMI, about the Unit Status.

Overall Status	Status text	Description
Off:	Keypad Disable	The Unit has been disabled by keypad. Check with your local maintenance if it can be enabled.
	Loc/Rem Switch	The Local/Remote enable switch is set to disable. Turn it to Local to enable the unit to start its starting sequence.

Overall Status	Status text	Description
Auto Auto:	BAS Disable	Unit is disabled by BAS/BMS system. Check with the BAS company how to start the unit.
	Master Disable	Unit is disabled by the Master Slave function
	Scheduler Disabled	Unit is disabled by the time scheduler.
	Unit Alarm	A unit alarm is active. Check the alarm list to see what is the active alarm inhibiting the unit to start and check if the alarm can be cleared. Refer to section 5. before proceeding.
	Test Mode	Unit mode set to Test. This mode is activated to check operability of onboard actuators and sensors. Check with the local maintenance if the Mode can be reverted to the one compatible with unit application (View/Set Unit – Set-Up – Available Modes).
	All Cir Disabled	No circuit is available to run. All circuits can be disabled by their individual enable switch or can be disabled by a component safety condition active or can be disabled by keypad or can be all in alarms. Check the individual circuit status for further details.
	Ice Mode Tmr	This status can be shown only if the unit can work in Ice Mode. The unit is off because the Ice setpoint has been satisfied. Unit will remain off until the Ice Timer has expired.
	OAT Lockout	The unit cannot run because the Outside Air Temperature is below the limit foreseen for the condenser temperature control system installed in this Unit. If the Unit has to run anyway check with your local maintenance how to proceed.
	Evap Recirc	Unit is in Auto control. The pump is running and at least one compressor is running.
	Wait For Flow	Unit is running the evaporator pump to equalize the water temperature in the evaporator.
	Wait For Load	Unit pump is running but the flow signal still indicate a lack of flow through the evaporator.
	Unit Cap Limit	Unit is in standby because the thermostat control satisfied the active setpoint.
	Current Limit	Demand limit has been hit. Unit capacity will not further increase.
	Noise Reduction	Maximum current has been hit. Unit capacity will not further increase.
	Max Pulldn	Unit is running with the Quiet Mode activated. Active setpoint may differ from what has been set as cooling setpoint.
Pumpdn	Unit thermostat control is limiting the unit capacity because the water temperature is dropping at a rate that could exceed the active setpoint.	
		Unit is shutting down.

4.2.3 Circuits Enable

As for the unit enable, the circuits can start only if all the enable setpoints/signals are active:

- Circuit Switch Enable (signal) = Enable
- Keypad Enable (setpoint) = Enable
-

Switch Enable		Software Enable	Circuit Status
Q1/Q2	State	Circuit Enable (Keypad Enable set point)	
0	Disabled	X	DISABLED
0	Disabled	X	DISABLED
1	Enabled	Disable	DISABLED
1	Enabled	Enable	ENABLED

4.2.4 Circuit Status

One of the texts strings listed in the table below will inform, on the HMI, about the Circuit Status.

Overall Status	Status	Description
Off:	Ready	Circuit is off waiting for a stage up signal from thermostat control
	Stage Up Delay	Circuit is off waiting for the stage up delay to expire.
	Cycle Timer	Circuit is off waiting for the compressor cycle timer to expire
	BAS Disable	Circuit is off by BAS signal. Check with the BAS company how to start the unit.
	Keypad Disable	Circuit is off by the local or remote HMI. Check with your local maintenance if it can be enabled.
	Circuit Switch	Circuit is off by Enable switch. Turn the Enable switch to 1 to allow the circuit start up procedure to start
	Oil Heating	Circuit is off because the oil temperature is too low to guarantee a proper lubrication of compressor. Heating resistor is activated to eliminate this temporary condition. It's suggested to power up the unit in advance to avoid this limiting condition.
	Alarm	A circuit alarm is active. Check the alarm list to see what is the active alarm inhibiting the circuit to start and check if the alarm can be cleared. Refer to section 5.before proceeding.
	Test Mode	Circuit mode set to Test. This mode is activated to check operability of onboard circuit actuators and sensors. Check with the local maintenance if the Mode can be reverted to Enable.
	Max Comp Starts	Compressor starts exceed the maximum number of starts per hour.
EXV Run:	VFD Heating	Inverter on compressor cannot start because of low internal temperature. Heating resistor is activated to eliminate this temporary condition. It's suggested to power up the unit in advance to avoid this limiting condition.
	Maintenance Preopen	A component needs to be replaced or maintained. Refer to section 5.before proceeding.
	Pumpdown	EXV repositioning before compressor starts.
	Normal	Circuit is shutting down because of thermostat control or pumpdown alarm or because the enable switch has been turned to off.
	Disch SH Low	Circuit is running within the expected operational conditions.
	Evap Press Low	Discharge superheat is below the acceptable value. This is a temporary condition that should disappear after few minutes of operation.
	Cond Press High	Circuit is running with low evaporator pressure. This could be due to a transitory condition or a lack of refrigerant. Check with the local maintenance if corrective actions are required. Circuit is protected by preventive logic.
	High LWT Limit	Circuit is running with high condenser pressure. This could be due to a transitory condition or high ambient temperature or problems with the condenser fans. Check with the local maintenance if corrective actions are required. Circuit will be protected by preventive logic.
	High VFD Amps	Circuit is running with a high water temperature. This is a temporary condition that will limit the maximum compressor capacity. Reduction of the water temperature will allow the compressor to reach the full capacity.

4.2.5 Circuit Preventions

4.2.5.1 High Water Temperature Limit

The only prevention that can activate at unit level will limit the maximum unit capacity to 80% when the leaving water temperature exceeds 25°C in cooling or 60°C in heating. This condition will be displayed at circuit level to indicate the capacity limitation.

Symptom	Cause	Solution
Unit maximum capacity equal to 80%	Leaving Evaporator water temperature higher than 25°C or Leaving Condenser water temperature higher than 60°C	Wait until the water temperature drops below 25°C

4.2.5.2 Low Evaporating Pressure

When the circuit is running and the evaporating pressure drops below the safety limits the circuit control logic reacts at two different levels in order to recover the normal running conditions.

If the evaporating pressure drops below the Low Pressure Hold limit, compressor is inhibited to increase its running capacity. This condition is indicated on the controller display in the circuit status as "Run: Evap Press Low". The status is automatically cleared when the evaporating pressure rise above the Low Pressure Hold limit by 14 kPa.

If the evaporating pressure drops below the Low Pressure Unld limit, compressor is unloaded in order to recover the normal operating conditions. This condition is indicated on the controller display in the circuit status as "Run: Evap Press Low". The status is automatically cleared when the evaporating pressure rise above the Low Pressure Hold limit by 14 kPa.

See section 5.6.18 to troubleshoot this problem.

4.2.5.3 High Condensing Pressure

When the circuit is running and the condensing pressure rises above the safety limits the circuit control logic reacts at two different levels in order to recover the normal running conditions.

The two different levels, called High Pressure Hold and High Pressure Unload limits, are calculated by the controller from the maximum condenser pressure allowed by the compressor envelope. This value depends from evaporating pressure as reported in the figure below.

If the condensing pressure rises above the High Pressure Hold limit, compressor is inhibited to increase its running capacity. This condition is indicated on the controller display in the circuit status as “Run: Cond Press High”. The limit is calculated in terms of saturated condensing temperature; the status is automatically cleared when the saturated condensing temperature rises above the High Pressure Hold limit by 5.6°C.

If the condensing pressure rises above the High Pressure Unload limit, compressor is unloaded in order to recover the normal operating conditions. This condition is indicated on the controller display in the circuit status as “Run: Cond Press High”. The status is automatically cleared when the saturated condensing temperature rises above the High Pressure Hold limit by 5.6°C. See section 5.6.17 to troubleshoot this problem.

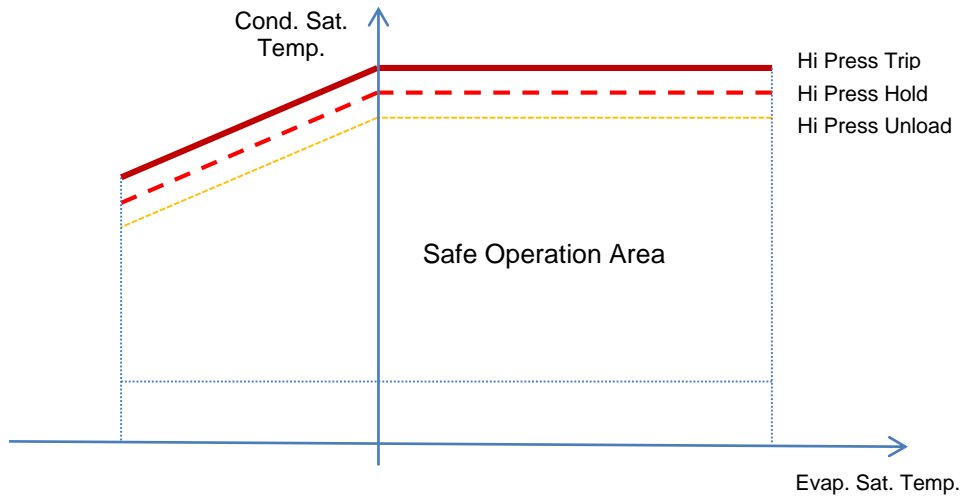

4.2.5.4 High Vfd Current

When the compressor is running and its output current rises above the safety limits the circuit control logic reacts at two different levels in order to recover the normal running conditions. Safety limits are calculated by the controller based on the selected compressor type.

If the running current rises above the Running Current Hold limit (101% of RLA), compressor is inhibited to increase its running capacity. This condition is indicated on the controller display in the circuit status as “Run: High VFD Amps”.

If the condensing pressure rises above the Running Current Unload limit (105% of RLA), compressor is unloaded in order to recover the normal operating conditions. This condition is indicated on the controller display in the circuit status as “Run: High VFD Amps”. The status is automatically cleared when the running amps falls below the hold limit.

4.2.5.5 High Discharge Temperature

When the compressor is running and its discharge temperature rises above the safety limits the circuit control logic reacts at two different levels in order to recover the normal running conditions.

If the discharge temperature rises above the Discharge Temperature Hold limit (95°C), compressor is inhibited to increase its running capacity. This condition is indicated on the controller display in the circuit status as “Run: High Discharge Temp”.

If the discharge temperature rises above the Discharge Temperature Unload limit (100°C), compressor is unloaded in order to recover the normal operating conditions. This condition is indicated on the controller display in the circuit status as “Run: High Discharge Temp”. The status is automatically cleared when the discharge temperature falls below the hold limit.

5 TROUBLESHOOTING

The UC protects the unit and the components from operating in abnormal conditions. Protections can be divided in preventions and alarms. Alarms can then be divided in pump-down and rapid stop alarms. Pump-down alarms are activated when the system or sub-system can perform a normal shutdown in spite of the abnormal running conditions. Rapid stop alarms are activated when the abnormal running conditions require an immediate stop of the whole system or sub-system to prevent potential damages.

The UC displays the active alarms in a dedicated page and keep an history of the last 50 entries divided between alarms and acknowledgements occurred. Time and date for each alarm event and of each alarm acknowledgement are stored.

The UC also stores alarm snapshot of each alarm occurred. Each item contains a snapshot of the running conditions right before the alarm has occurred. Different sets of snapshots are programmed corresponding to unit alarms and circuit alarms holding different information to help the failure diagnosis.

In the following sections it will also be indicated how each alarm can be cleared between local HMI, Network (by any of the high level interfaces Modbus, Bacnet or Lon) or if the specific alarm will clear automatically. The following symbols are used:

- Allowed
- Not allowed
- Not foreseen

5.1 Unit Alerts

5.1.1 Bad Current Limit Input

This alarm is generated when the Flexible Current Limit option has been enabled and the input to the controller is out of the admitted range.

Symptom	Cause	Solution
Unit status is Run. Bell icon is moving on controller's display. Flexible Current Limit function cannot be used. String in the alarm list: BadCurrentLimitInput String in the alarm log: ± BadCurrentLimitInput String in the alarm snapshot BadCurrentLimitInput	Flexible current limit input out of range. For this warning out of range is considered to be a signal less than 3mA or more than 21mA.	Check for values of input signal to the unit controller. It has to be in the allowed mA range. Check for electrical shielding of wirings. Check for right value of the unit's controller output in case input signal is into allowed range.
Reset		Notes
Local HMI	<input type="checkbox"/>	Automatically clears when the signal returns in the allowed range.
Network	<input type="checkbox"/>	
Auto	<input checked="" type="checkbox"/>	

5.1.2 Bad Demand Limit Input

This alarm is generated when the Demand Limit option has been enabled and the input to the controller is out of the admitted range.

Symptom	Cause	Solution
Unit status is Run. Bell icon is moving on controller's display. Demand Limit function cannot be used. String in the alarm list: BadDemandLimitInput String in the alarm log: ±BadDemandLimitInput String in the alarm snapshot BadDemandLimitInput	Demand limit input out of range For this warning out of range is considered to be a signal less than 3mA or more than 21mA.	Check for values of input signal to the unit controller. It has to be in the allowed mA range; Check for electrical shielding of wirings. Check for right value of the unit's controller output in case input signal is into allowed range.
Reset		Notes
Local HMI	<input type="checkbox"/>	Automatically clears when the signal returns in the allowed range.
Network	<input type="checkbox"/>	
Auto	<input checked="" type="checkbox"/>	

5.1.3 Bad Leaving Water Temperature Reset Input

This alarm is generated when the Setpoint Reset option has been enabled and the input to the controller is out of the admitted range.

Symptom	Cause	Solution
Unit status is Run. Bell icon is moving on controller's display. LWT Reset function cannot be used. String in the alarm list: BadSetPtOverrideInput String in the alarm log: ± BadSetPtOverrideInput String in the alarm snapshot BadSetPtOverrideInput	LWT reset input signal is out of range. For this warning out of range is considered to be a signal less than 3mA or more than 21mA.	Check for values of input signal to the unit controller. It has to be in the allowed mA range. Check for electrical shielding of wirings. Check for right value of the unit's controller output in case input signal is into allowed range.
Reset		Notes
Local HMI	<input type="checkbox"/>	Automatically clears when the signal returns in the allowed range.
Network	<input type="checkbox"/>	
Auto	<input checked="" type="checkbox"/>	

5.1.4 Condenser Pump #1 Failure

This alarm is generated if the pump is started but the flow switch is not able to close within the recirculate time. This can be a temporary condition or may be due to a broken flowswitch, the activation of circuit breakers, fuses or to a pump breakdown.

Symptom	Cause	Solution
Unit could be ON. Bell icon is moving on controller's display. Backup pump is used or stop of all circuits in case of pump #2 failure. String in the alarm list: CondPump1Fault String in the alarm log: ± CondPump1Fault String in the alarm snapshot CondPump1Fault	Pump #1 may not be operating. Flow Switch doesn't operate properly	Check for problem in electrical wiring of the pump #1. Check that electrical breaker of pump #1 is tripped. If fuses are used to protect the pump, check the integrity of fuses. Check for problem in wiring connection between pump starter and unit controller. Check the water pump filter and the water circuit for obstructions. Check flow switch connection and calibration.
Reset		Notes
Local HMI	<input checked="" type="checkbox"/>	
Network	<input checked="" type="checkbox"/>	
Auto	<input type="checkbox"/>	

5.1.5 Condenser Pump #2 Failure

This alarm is generated if the pump is started but the flow switch is not able to close within the recirculate time. This can be a temporary condition or may be due to a broken flowswitch, the activation of circuit breakers, fuses or to a pump breakdown.

Symptom	Cause	Solution
Unit could be ON. Bell icon is moving on controller's display. Backup pump is used or stop of all circuits in case of pump #1 failure. String in the alarm list: CondPump2Fault String in the alarm log: ± CondPump2Fault String in the alarm snapshot CondPump2Fault	Pump #1 may not be operating. Flow Switch doesn't operate properly	Check for problem in electrical wiring of the pump #1. Check that electrical breaker of pump #1 is tripped. If fuses are used to protect the pump, check the integrity of fuses. Check for problem in wiring connection between pump starter and unit controller. Check the water pump filter and the water circuit for obstructions. Check flow switch connection and calibration.
Reset		Notes
Local HMI	<input checked="" type="checkbox"/>	
Network	<input checked="" type="checkbox"/>	
Auto	<input type="checkbox"/>	

5.1.6 Energy Meter Communication Fail

This alarm is generated in case of communication problems with the energy meter.

Symptom	Cause	Solution
---------	-------	----------

Bell icon is moving on controller's display.
String in the alarm list:
EnergyMtrCommFail
String in the alarm log:
± EnergyMtrCommFail
String in the alarm snapshot
EnergyMtrCommFail

Module has no power supply

Wrong cabling with the Unit Controller

Modbus parameters not properly set

Module is broken

Refer to the datasheet of the specific component to see if it is correctly powered

Check if the polarity of the connections is respected.

Referring to the datasheet of the specific component to see if the modbus parameters are set correctly:
Address = 20
Baud Rate =19200 kBs
Parity = None
Stop bits =1
Check if the display shows something and the power supply is present.

Reset

Local HMI
Network
Auto

Notes

Automatically clears when the communication is re-established.

5.1.7 Evaporator Pump #1 Failure

This alarm is generated if the pump is started but the flow switch is not able to close within the recirculate time. This can be a temporary condition or may be due to a broken flowswitch, the activation of circuit breakers, fuses or to a pump breakdown.

Symptom	Cause	Solution
Unit could be ON. Bell icon is moving on controller's display. Backup pump is used or stop of all circuits in case of pump #2 failure. String in the alarm list: EvapPump1Fault String in the alarm log: ± EvapPump1Fault String in the alarm snapshot EvapPump1Fault	Pump #1 may not be operating. Flow Switch doesn't operate properly	Check for problem in electrical wiring of the pump #1. Check that electrical breaker of pump #1 is tripped. If fuses are used to protect the pump, check the integrity of fuses. Check for problem in wiring connection between pump starter and unit controller. Check the water pump filter and the water circuit for obstructions. Check flow switch connection and calibration.

Reset

Local HMI
Network
Auto

Notes

5.1.8 Evaporator Pump #2 Failure

This alarm is generated if the pump is started but the flow switch is not able to close within the recirculate time. This can be a temporary condition or may be due to a broken flowswitch, the activation of circuit breakers, fuses or to a pump breakdown.

Symptom	Cause	Solution
Unit could be ON. Bell icon is moving on controller's display. Backup pump is used or stop of all circuits in case of pump #1 failure. String in the alarm list: EvapPump2Fault String in the alarm log: ± EvapPump2Fault String in the alarm snapshot EvapPump2Fault	Pump #2 may not be operating. Flow Switch doesn't operate properly	Check for problem in electrical wiring of the pump #2. Check that electrical breaker of pump #2 is tripped. If fuses are used to protect the pump, check the integrity of fuses. Check for problem in wiring connection between pump starter and unit controller. Check the water pump filter and the water circuit for obstructions. Check flow switch connection and calibration.

Reset

Local HMI
Network
Auto

Notes

5.1.9 External Event

This alarm indicates that a device, whose operation is linked with this unit, is reporting a problem on the dedicated input.

Symptom	Cause	Solution
Unit status is Run. Bell icon is moving on controller's display. String in the alarm list: UnitExternalEvent String in the alarm log: ±UnitExternalEvent String in the alarm snapshot UnitExternalEvent	There is an external event that has caused the opening, for at least 5 seconds, of the digital input on the controller board.	Check for reasons of external event and if it can be a potential problem for a correct chiller operation.

Reset	Notes
Local HMI <input type="checkbox"/>	The alarm is automatically cleared when the problem is solved.
Network <input type="checkbox"/>	
Auto <input checked="" type="checkbox"/>	
NOTE: What above applies in case of configuration of the external fault digital input as Event	

5.1.10 Fan Alarm Module Communication Fail

This alarm is generated in case of communication problems with the FAC module.

Symptom	Cause	Solution
Bell icon is moving on controller's display. String in the alarm list: FanMdlCommFail String in the alarm log: ± FanMdlCommFail String in the alarm snapshot FanMdlCommFail	Module has no power supply	Check the power supply from the connector on the side of the module. Check if LEDs are both green. Check if the connector on the side is tightly inserted in the module
	Module address is not properly set	Check if module's address is correct referring to the wiring diagram.
	Module is broken	Check if LED are on and both green. If BSP LED is solid red replace the module Check if power supply is ok but LEDs are both off. In this case replace the module

Reset	Notes
Local HMI <input checked="" type="checkbox"/>	
Network <input checked="" type="checkbox"/>	
Auto <input type="checkbox"/>	

5.1.11 Heat Recovery Entering Water Temperature sensor fault

This alarm is generated any time that the input resistance is out of an acceptable range.

Symptom	Cause	Solution
Unit status is Off. All circuits are stopped with a normal shutdown procedure. Bell icon is moving on controller's display. String in the alarm list: UnitAlHREwtSen String in the alarm log: ± UnitAlHREwtSen String in the alarm snapshot UnitAlHREwtSen	Sensor is broken.	Check for sensor integrity according table and allowed kOhm (kΩ) range. Check correct sensors operation
	Sensor is shorted.	Check if sensor is shorted with a resistance measurement.
	Sensor is not properly connected (open).	Check for absence of water or humidity on electrical contacts. Check for correct plug-in of the electrical connectors. Check for correct sensors wiring also according electrical scheme.

Reset	Notes
Local HMI <input checked="" type="checkbox"/>	
Network <input checked="" type="checkbox"/>	
Auto <input type="checkbox"/>	

5.1.12 Heat Recovery Leaving Water Temperature sensor fault

This alarm is generated any time that the input resistance is out of an acceptable range.

Symptom	Cause	Solution
Heat Recovery is Off Bell icon is moving on controller's display. String in the alarm list: UnitAlHRLvgSen String in the alarm log: ± UnitAlHRLvgSen String in the alarm snapshot UnitAlHRLvgSen	Sensor is broken.	Check for sensor integrity according table and allowed kOhm (kΩ) range. Check correct sensors operation
	Sensor is shorted.	Check if sensor is shorted with a resistance measurement.
	Sensor is not properly connected (open).	Check for absence of water or humidity on electrical contacts.

Check for correct plug-in of the electrical connectors.
Check for correct sensors wiring also according electrical scheme.

Reset		Notes
Local HMI	<input checked="" type="checkbox"/>	
Network	<input checked="" type="checkbox"/>	
Auto	<input type="checkbox"/>	

5.1.13 Heat Recovery Water Temperatures inverted

This alarm is generated any time that the heat recovery entering water temperature is lower than the leaving by 1°C and at least one compressor is running.

Symptom	Cause	Solution
Bell icon is moving on controller's display. Bell icon is moving on controller's display. String in the alarm list: Unit HRInvAl	Entering and leaving water temperature sensors are inverted.	Check cabling of the sensors on the unit controller. Check offset of the two sensors with the water pump running
String in the alarm log: ± Unit HRInvAl	Entering and leaving water pipes are reversed	Check if the water flows in counter flow respect to refrigerant.
String in the alarm snapshot Unit HRInvAl	Water pump operate reverse.	Check if the water flows in counter flow respect to refrigerant.

Reset		Notes
Local HMI	<input checked="" type="checkbox"/>	
Network	<input checked="" type="checkbox"/>	
Auto	<input type="checkbox"/>	

5.1.14 Rapid Recovery Module Communication Fail

This alarm is generated in case of communication problems with the RRC module.

Symptom	Cause	Solution
Bell icon is moving on controller's display. String in the alarm list: RpdRcvryCommFail	Module has no power supply	Check the power supply from the connector on the side of the module. Check if LEDs are both green.
String in the alarm log: ± RpdRcvryCommFail		Check if the connector on the side is tightly inserted in the module
String in the alarm snapshot RpdRcvryCommFail	Module address is not properly set	Check if module's address is correct referring to the wiring diagram.
	Module is broken	Check if LED are on and both green. If BSP LED is solid red replace the module Check if power supply is ok but LEDs are both off. In this case replace the module

Reset		Notes
Local HMI	<input checked="" type="checkbox"/>	
Network	<input checked="" type="checkbox"/>	
Auto	<input type="checkbox"/>	

5.1.15 Switch Box Temperature sensor fault

This alarm is generated any time that the input resistance is out of an acceptable range.

Symptom	Cause	Solution
Unit status is On Bell icon is moving on controller's display. Bell icon is moving on controller's display.	Sensor is broken.	Check for sensor integrity according table and allowed kOhm (kΩ) range. Check correct sensors operation
String in the alarm list: SwitchBoxTempSen		
String in the alarm log: ± SwitchBoxTempSen	Sensor is shorted.	Check if sensor is shorted with a resistance measurement.
String in the alarm snapshot SwitchBoxTempSen	Sensor is not properly connected (open).	Check for absence of water or humidity on electrical contacts. Check for correct plug-in of the electrical connectors. Check for correct sensors wiring also according electrical scheme.

Reset		Notes
Local HMI	<input checked="" type="checkbox"/>	
Network	<input checked="" type="checkbox"/>	
Auto	<input type="checkbox"/>	

5.2 Unit Pumpdown Stop Alarms

5.2.1 Condenser Entering Water Temperature (EWT) sensor fault

This alarm is generated any time the input resistance is out of an acceptable range.

Symptom	Cause	Solution
Unit status is Off. All circuits are stopped with a normal shutdown procedure. Bell icon is moving on controller's display. String in the alarm list: UnitOffCndEntWTempSen String in the alarm log: ± UnitOffCndEntWTempSen String in the alarm snapshot UnitOffcndEntWTempSen	Sensor is broken. Sensor is shorted. Sensor is not properly connected (open).	Check for sensor integrity, according table and allowed kOhm (kΩ) range. Check correct sensors operation Check if sensor is shorted with a resistance measurement. Check for absence of water or humidity on electrical contacts. Check for correct plug-in of the electrical connectors. Check for correct sensors wiring also according electrical scheme.
Reset		Notes
Local HMI	<input checked="" type="checkbox"/>	
Network	<input checked="" type="checkbox"/>	
Auto	<input type="checkbox"/>	

5.2.2 Condenser Leaving Water Temperature (LWT) sensor fault

This alarm is generated any time the input resistance is out of an acceptable range.

Symptom	Cause	Solution
Unit status is Off. All circuits are stopped with a normal shutdown procedure. Bell icon is moving on controller's display. String in the alarm list: UnitOffCndLvgWTempSen String in the alarm log: ± UnitOffCndLvgWTempSen String in the alarm snapshot UnitOffcndLvgWTempSen	Sensor is broken. Sensor is shorted. Sensor is not properly connected (open).	Check for sensor integrity, according table and allowed kOhm (kΩ) range. Check correct sensors operation Check if sensor is shorted with a resistance measurement. Check for absence of water or humidity on electrical contacts. Check for correct plug-in of the electrical connectors. Check for correct sensors wiring also according electrical scheme.
Reset		Notes
Local HMI	<input checked="" type="checkbox"/>	
Network	<input checked="" type="checkbox"/>	
Auto	<input type="checkbox"/>	

5.2.3 Evaporator Entering Water Temperature (EWT) sensor fault

This alarm is generated any time the input resistance is out of an acceptable range.

Symptom	Cause	Solution
Unit status is Off. All circuits are stopped with a normal shutdown procedure. Bell icon is moving on controller's display. String in the alarm list: UnitOffEvpEntWTempSen String in the alarm log: ± UnitOffEvpEntWTempSen String in the alarm snapshot UnitOffEvpEntWTempSen	Sensor is broken. Sensor is shorted. Sensor is not properly connected (open).	Check for sensor integrity, according table and allowed kOhm (kΩ) range. Check correct sensors operation Check if sensor is shorted with a resistance measurement. Check for absence of water or humidity on electrical contacts. Check for correct plug-in of the electrical connectors. Check for correct sensors wiring also according electrical scheme.
Reset		Notes
Local HMI	<input checked="" type="checkbox"/>	
Network	<input checked="" type="checkbox"/>	

5.2.4 Evaporator Water Temperatures inverted

This alarm is generated any time the entering water temperature is lower than the leaving by 1°C and at least one compressor is running since 90 seconds.

Symptom	Cause	Solution
Unit status is Off. All circuits are stopped with a normal shutdown procedure. Bell icon is moving on controller's display. String in the alarm list: UnitOffEvpWTempInvrtd String in the alarm log: ± UnitOffEvpWTempInvrtd String in the alarm snapshot UnitOffEvpWTempInvrtd	Entering and leaving water temperature sensors are inverted. Entering and leaving water pipes are reversed Water pump operate reverse.	Check cabling of the sensors on the unit controller. Check offset of the two sensors with the water pump running Check if the water flows in counter flow respect to refrigerant. Check if the water flows in counter flow respect to refrigerant.
Reset	Notes	
Local HMI	<input checked="" type="checkbox"/>	
Network	<input checked="" type="checkbox"/>	
Auto	<input type="checkbox"/>	

5.2.5 Outside Air Temperature (OAT) Lockout

This alarm prevents the unit to start if the outside air temperature is too low. Purpose is to prevent low pressure trips at startup. The limit depends on the fan regulation that is installed on the unit. By default this value is set to 10°C.

Symptom	Cause	Solution
Unit Status is OAT Lockout. All circuits are stopped with a normal shutdown procedure. Bell icon is moving on controller's display. String in the alarm list: StartInhbtAmbTempLo String in the alarm log: ± StartInhbtAmbTempLo String in the alarm snapshot StartInhbtAmbTempLo	Outside ambient temperature is lower than value set into unit's controller. Improper operation of Outside Ambient Temperature sensor.	Check the minimum outside ambient temperature value set into the unit's controller. Check if this value is in accordance with chiller application, therefore check about the proper application and utilization of the chiller. Check for proper operation of OAT sensor according information about kOhm (kΩ) range related to temperature values.
Reset	Notes	
Local HMI	<input type="checkbox"/>	It clears automatically with a 2.5°C of hysteresis.
Network	<input type="checkbox"/>	
Auto	<input checked="" type="checkbox"/>	

5.2.6 Outside Air Temperature sensor fault alarm

This alarm is generated any time the input resistance is out of an acceptable range.

Symptom	Cause	Solution
Unit status is Off. All circuits are stopped with a normal shutdown procedure. Bell icon is moving on controller's display. String in the alarm list: UnitOffAmbTempSen String in the alarm log: ± UnitOffAmbTempSen String in the alarm snapshot UnitOffAmbTempSen	Sensor is broken. Sensor is shorted. Sensor is not properly connected (open).	Check for sensor integrity. Check correct sensors operation according table and allowed kOhm (kΩ) range. Check if sensor is shorted with a resistance measurement. Check for absence of water or humidity on electrical contacts. Check for correct plug-in of the electrical connectors. Check for correct sensors wiring also according electrical scheme.
Reset	Notes	
Local HMI	<input checked="" type="checkbox"/>	
Network	<input checked="" type="checkbox"/>	
Auto	<input type="checkbox"/>	

5.3 Unit Rapid Stop Alarms

5.3.1 Condenser Water Freeze alarm

This alarm is generated to indicate that the water temperature (entering or leaving) has dropped below a safety limit. Control tries to protect the heat exchanger starting the pump and letting the water circulate.

Symptom	Cause	Solution
---------	-------	----------

Unit status is Off. All circuits are stopped immediately. Bell icon is moving on controller's display. String in the alarm list: UnitOffCondWaterTmpLo String in the alarm log: ± UnitOffCondWaterTmpLo String in the alarm snapshot UnitOffCondWaterTmpLo	Water flow too low. Inlet temperature to the evaporator is too low. Flow switch is not working or no water flow. Refrigerant temperature become too low (< -0.6°C). Sensors readings (entering or leaving) are not properly calibrated Wrong freeze limit setpoint	Increase the water flow. Increase the inlet water temperature. Check the flow switch and the water pump. Check the water flow and filter. No good heat exchange condition into the evaporator. Check the water temperatures with a proper instrument and adjust the offsets The freeze limit has not been changed as a function of glycol percentage.
--	---	--

Reset		Notes
Local HMI	<input checked="" type="checkbox"/>	It's required to check if the condenser has any damage due to this alarm.
Network	<input checked="" type="checkbox"/>	
Auto	<input type="checkbox"/>	

5.3.2 Condenser Water Flow Loss alarm

This alarm is generated in case of flow loss to the chiller to protect the unit against Mechanical High Pressure trips.

Symptom	Cause	Solution
Unit status is Off. All circuits are stopped immediately. Bell icon is moving on controller's display. String in the alarm list: UnitOffCondWaterFlow String in the alarm log: ± UnitOffCondWaterFlow String in the alarm snapshot UnitOffCondWaterFlow	No water flow sensed for 3 minutes continuously or water flow too low.	Check the water pump filler and the water circuit for obstructions. Check the flow switch calibration and adapt to minimum water flow. Check if pump impeller can rotate freely and has no damages. Check pumps protection devices (circuit breakers, fuses, inverters, etc.) Check if water filter is clogged. Check flow switch connections.

Reset		Notes
Local HMI	<input checked="" type="checkbox"/>	
Network	<input checked="" type="checkbox"/>	
Auto	<input type="checkbox"/>	

5.3.3 Emergency Stop

This alarm is generated any time the Emergency Stop button is activated.



Before resetting the Emergency Stop button please verify that the harmful condition has been removed.

Symptom	Cause	Solution
Unit status is Off. All circuits are stopped immediately. Bell icon is moving on controller's display. String in the alarm list: UnitOffEmergencyStop String in the alarm log: ± UnitOffEmergencyStop String in the alarm snapshot UnitOffEmergencyStop	Emergency stop button has been pushed.	Turning counterclockwise the emergency stop button, the alarm should be cleared.

Reset		Notes
Local HMI	<input checked="" type="checkbox"/>	Please see note on the top.
Network	<input checked="" type="checkbox"/>	
Auto	<input type="checkbox"/>	

5.3.4 Evaporator Flow Loss alarm

This alarm is generated in case of flow loss to the chiller to protect the unit against freezing.

Symptom	Cause	Solution
Unit status is Off. All circuits are stopped immediately. Bell icon is moving on controller's display. String in the alarm list: UnitOffEvapWaterFlow	No water flow sensed for 3 minutes continuously or water flow too low.	Check the water pump filler and the water circuit for obstructions. Check the flow switch calibration and adapt to minimum water flow.

String in the alarm log:
± UnitOffEvapWaterFlow
String in the alarm snapshot
UnitOffEvapWaterFlow

Check if pump impeller can rotate freely and has no damages.
Check pumps protection devices (circuit breakers, fuses, inverters, etc.)
Check if water filter is clogged.
Check flow switch connections.

Reset		Notes
Local HMI	<input checked="" type="checkbox"/>	
Network	<input checked="" type="checkbox"/>	
Auto	<input type="checkbox"/>	

5.3.5 Evaporator Leaving Water Temperature (LWT) sensor fault

This alarm is generated any time that the input resistance is out of an acceptable range.

Symptom	Cause	Solution
Unit status is Off. All circuits are stopped with a normal shutdown procedure. Bell icon is moving on controller's display. String in the alarm list: UnitOffLvgEntWTempSen String in the alarm log: ± UnitOffLvgEntWTempSen String in the alarm snapshot UnitOffEvpLvgWTempSen	Sensor is broken.	Check for sensor integrity, according table and allowed kOhm (kΩ) range. Check correct sensors operation
	Sensor is shorted.	Check if sensor is shorted with a resistance measurement.
	Sensor is not properly connected (open).	Check for absence of water or humidity on electrical contacts. Check for correct plug-in of the electrical connectors. Check for correct sensors wiring also according electrical scheme.

Reset		Notes
Local HMI	<input checked="" type="checkbox"/>	
Network	<input checked="" type="checkbox"/>	
Auto	<input type="checkbox"/>	

5.3.6 Evaporator Water Freeze alarm

This alarm is generated to indicate that the water temperature (entering or leaving) has dropped below a safety limit. Control tries to protect the heat exchanger starting the pump and letting the water circulate.

Symptom	Cause	Solution
Unit status is Off. All circuits are stopped immediately. Bell icon is moving on controller's display. String in the alarm list: UnitOffEvapWaterTmpLo String in the alarm log: ± UnitOffEvapWaterTmpLo String in the alarm snapshot UnitOffEvapWaterTmpLo	Water flow too low.	Increase the water flow.
	Inlet temperature to the evaporator is too low.	Increase the inlet water temperature.
	Flow switch is not working or no water flow.	Check the flow switch and the water pump.
	Sensors readings (entering or leaving) are not properly calibrated.	Check the water temperatures with a proper instrument and adjust the offsets
	Wrong freeze limit setpoint.	The freeze limit has not been changed as a function of glycol percentage.

Reset		Notes
Local HMI	<input checked="" type="checkbox"/>	
Network	<input checked="" type="checkbox"/>	It's required to check if the evaporator has any damage due to this alarm.
Auto	<input type="checkbox"/>	

5.3.7 External alarm

This alarm is generated to indicate that an external device whose operation is linked with this unit operation. This external device could be a pump or an inverter.

Symptom	Cause	Solution
Unit status is Off. All circuits are switched off with the normal shutdown procedure. Bell icon is moving on controller's display. String in the alarm list: UnitOffExternalAlarm String in the alarm log: ± UnitOffExternalAlarm String in the alarm snapshot UnitOffExternalAlarm	There is an external event that has caused the opening, for at least 5 seconds, of the port on the controller board.	Check causes of the external event or alarm. Check electrical wiring from unit controller to the external equipment in case of any external events or alarms have been occurred.

Reset	Notes
Local HMI <input checked="" type="checkbox"/>	
Network <input checked="" type="checkbox"/>	
Auto <input type="checkbox"/>	
NOTE: What above applies in case of configuration of the external fault digital input as Alarm.	

5.3.8 Gas Leakage Alarm

This alarm is generated when the external leak detector(s) detects a refrigerant concentration higher than a threshold. To clear this alarm is required to clear the alarm either locally and, if needed, on the leak detector itself.

Symptom	Cause	Solution
Unit status is Off. All circuits are stopped immediately. Bell icon is moving on controller's display. String in the alarm list: UnitOffGasLeakage String in the alarm log: ± UnitOffGasLeakage String in the alarm snapshot UnitOffGasLeakage	Refrigerant leakage Leak detector is not properly powered Leak detector is not properly connected to the controller. Leak detector is broken Leak detector is not required/needed	Locate the leakage with a sniffer and fix the leakage Check the power supply of the leak detector. Check the connection of the detector with reference to the wiring diagram of the unit. Replace the leak detector. Check the configuration on the unit controller and disable this option.

Reset	Notes
Local HMI <input checked="" type="checkbox"/>	
Network <input checked="" type="checkbox"/>	
Auto <input type="checkbox"/>	

5.3.9 Heat Recovery Water Freeze Protect alarm

This alarm is generated to indicate that the heat recovery water temperature (entering or leaving) has dropped below a safety limit. Control tries to protect the heat exchanger starting the pump and letting the water circulate.

Symptom	Cause	Solution
Unit status is Off. All circuits are stopped immediately. Bell icon is moving on controller's display. String in the alarm list: UnitOff HRFreeze String in the alarm log: ± UnitOff HRFreeze String in the alarm snapshot UnitOff HRFreeze	Water flow too low. Inlet temperature to the heat recovery is too low. Sensors readings (entering or leaving) are not properly calibrated	Increase the water flow. Increase the inlet water temperature. Check the water temperatures with a proper instrument and adjust the offsets

Reset	Notes
Local HMI <input checked="" type="checkbox"/>	
Network <input checked="" type="checkbox"/>	
Auto <input type="checkbox"/>	

5.3.10 OptionCtrlrCommFail

This alarm is generated in case of communication problems with the AC module.

Symptom	Cause	Solution
Unit status is Off. All circuits are stopped immediately. Bell icon is moving on controller's display. String in the alarm list: OptionCtrlrCommFail String in the alarm log: ± OptionCtrlrCommFail String in the alarm snapshot OptionCtrlrCommFail	Module has no power supply Module address is not properly set Module is broken	Check the power supply from the connector on the side of the module. Check if LEDs are both green. Check if the connector on the side is tightly inserted in the module Check if module's address is correct referring to the wiring diagram. Check if LED are on and both green. If BSP LED is solid red replace the module Check if power supply is ok but LEDs are both off. In this case replace the module

Reset	Notes
Local HMI <input checked="" type="checkbox"/>	
Network <input checked="" type="checkbox"/>	
Auto <input type="checkbox"/>	

5.3.11 Power Fault

This alarm is generated when the main power is Off and the unit controller is powered by the UPS.



Resolution of this fault requires a direct intervention on the power supply of this unit. Direct intervention on the power supply can cause electrocution, burns or even death. This action must be performed only by trained persons. In case of doubts contact your maintenance company.

Symptom	Cause	Solution
Unit status is Off. All circuits are stopped immediately. Bell icon is moving on controller's display. String in the alarm list: Power Fault String in the alarm log: ± Power Fault String in the alarm snapshot Power Fault	Loss of one phase. Not correct sequence connection of L1,L2,L3. Voltage level on the unit's panel is not in the allowed range (±10%). There is a short-circuit on the unit.	Check voltage level on each of the phases. Check sequence of L1, L2, L3 connections according indication on chiller's electrical scheme. Check that voltage level on each phases is into the allowed range that is indicated on the chiller label. Is important to check the voltage level on each phases not only with chiller not running, but mainly with chiller running from minimum capacity up to full load capacity. That's because voltage drop can occur from a certain unit cooling capacity level, or because of certain working condition (i.e. high values of OAT); In these cases the issue can be related with the sizing of power cables. Check for correct electrical isolation condition of each unit's circuit with a Megger tester.
Reset		Notes
Local HMI	<input checked="" type="checkbox"/>	
Network	<input checked="" type="checkbox"/>	
Auto		

5.3.12 PVM alarm

This alarm is generated in case of problems with the power supply to the chiller.



Resolution of this fault requires a direct intervention on the power supply of this unit. Direct intervention on the power supply can cause electrocution, burns or even death. This action must be performed only by trained persons. In case of doubts contact your maintenance company.

Symptom	Cause	Solution
Unit status is Off. All circuits are stopped immediately. Bell icon is moving on controller's display. String in the alarm list: UnitOffPhaveVoltage String in the alarm log: ± UnitOffPhaveVoltage String in the alarm snapshot UnitOffPhaveVoltage	Loss of one phase. Not correct sequence connection of L1,L2,L3. Voltage level on the unit's panel is not in the allowed range (±10%). There is a short-circuit on the unit.	Check voltage level on each of the phases. Check sequence of L1, L2, L3 connections according indication on chiller's electrical scheme. Check that voltage level on each phases is into the allowed range that is indicated on the chiller label. Is important to check the voltage level on each phases not only with chiller not running, but mainly with chiller running from minimum capacity up to full load capacity. That's because voltage drop can occur from a certain unit cooling capacity level, or because of certain working condition (i.e. high values of OAT); In these cases the issue can be related with the sizing of power cables. Check for correct electrical isolation condition of each unit's circuit with a Megger tester.
Reset		Notes
Local HMI	<input type="checkbox"/>	
Network	<input type="checkbox"/>	
Auto	<input checked="" type="checkbox"/>	

5.4 Circuit Alerts

5.4.1 Economizer Pressure Sensor fault

This alarm is generated to indicate that the sensor is not reading properly.

Symptom	Cause	Solution
Circuit status is On. Economizer is Off. Bell icon is moving on controller's display. String in the alarm list: Cx EcoPressSen String in the alarm log: ± Cx EcoPressSen String in the alarm snapshot Cx EcoPressSen	Sensor is broken. Sensor is shorted. Sensor is not properly connected (open).	Check for sensor integrity. Check correct sensors operation according information about mVolt (mV) range related to pressure values in kPa. Check if sensor is shorted with a resistance measurement. Check for correct installation of the sensor on refrigerant circuit pipe. The transducer must be able to sense the pressure through the valve's needle. Check for absence of water or humidity on sensor electrical contacts. Check for correct plug-in of the electrical connectors. Check for correct sensors wiring also according electrical scheme.
Reset		Notes
Local HMI Network Auto	<input checked="" type="checkbox"/> <input checked="" type="checkbox"/> <input type="checkbox"/>	

5.4.2 Economizer Temperature Sensor fault

This alarm is generated to indicate that the sensor is not reading properly.

Symptom	Cause	Solution
Circuit status is On. Economizer is Off. Bell icon is moving on controller's display. String in the alarm list: Cx EcoTempSen String in the alarm log: ± Cx EcoTempSen String in the alarm snapshot Cx EcoTempSen	Sensor is shorted. Sensor is broken. Sensor is not good connected (open).	Check for sensor integrity. Check correct sensors operation according information about kOhm (kΩ) range related to temperature values. Check if sensor is shorted with a resistance measurement. Check for correct installation of the sensor on refrigerant circuit pipe. Check for absence of water or humidity on sensor electrical contacts. Check for correct plug-in of the electrical connectors. Check for correct sensors wiring also according with electrical scheme.
Reset		Notes
Local HMI Network Auto	<input checked="" type="checkbox"/> <input checked="" type="checkbox"/> <input type="checkbox"/>	

5.4.3 Failed Pumpdown

This alarm is generated to indicate that the circuit hadn't been able to remove all the refrigerant from the evaporator. It automatically clear as soon as the compressor stops just to be logged in the alarm history. It may not be recognized from BMS because the communication latency can give enough time for the reset. It may not even be seen on the local HMI.

Symptom	Cause	Solution
Circuit status is Off. No indications on the screen String in the alarm list: -- String in the alarm log: ± Cx Failed Pumpdown String in the alarm snapshot Cx Failed Pumpdown	EEXV is not closing completely, therefore there's "short-circuit" between high pressure side with low pressure side of the circuit. Evaporating pressure sensor is not working properly. Compressor on circuit is internally damaged with a mechanical problems for example on internal check-valve, or on internal spirals or vanes.	Check for proper operation and full closing position of EEXV. Sight glass should not show refrigerant flow after the valve is closed. Check LED on the top of the valve, C LED should be solid green. If both LED are blinking alternately the valve motor is not properly connected. Check for proper operation of evaporating pressure sensor. Check compressors on circuits.
Reset		Notes
Local HMI Network Auto	<input type="checkbox"/> <input type="checkbox"/> <input checked="" type="checkbox"/>	

5.4.4 Fan Fault

This alarm indicates that at least one of the fans could has some problems

Symptom	Cause	Solution
Circuit status is On. The compressor keep operating as normal. Bell icon is moving on controller's display. String in the alarm list: Cx FanAlm String in the alarm log: ± Cx FanAlm String in the alarm snapshot Cx FanAlm	At least one of the fan has some problems	In case of on/off fan check the thermal magnetic circuit breaker of each fan. The fan could absorbs too much current In case of fan with VFD check the alarm output of the and message error provided by each fan VFD
Reset		Notes
Local HMI	<input checked="" type="checkbox"/>	
Network	<input checked="" type="checkbox"/>	
Auto	<input type="checkbox"/>	

5.4.5 Gas Leakage Sensor fault

This alarm is generated to indicate that the sensor is not reading properly.

Symptom	Cause	Solution
Circuit status is On. Bell icon is moving on controller's display. String in the alarm list: Cx GasLeakSen String in the alarm log: ± Cx GasLeakSen String in the alarm snapshot Cx GasLeakSen	Sensor is broken. Sensor is shorted. Sensor is not properly connected (open).	Check for sensor integrity. Check correct sensors operation according information about mVolt (mV) range related to ppm values. Check if sensor is shorted with a resistance measurement. Check for correct installation of the sensor. Check for absence of water or humidity on sensor electrical contacts. Check for correct plug-in of the electrical connectors. Check for correct sensors wiring also according electrical scheme.
Reset		Notes
Local HMI	<input checked="" type="checkbox"/>	
Network	<input checked="" type="checkbox"/>	
Auto	<input type="checkbox"/>	

5.4.6 CxCmp1 MaintCode01

This alarm indicates that a component in the inverter may require verification or even a replacement.

Symptom	Cause	Solution
Circuit status is On. The compressor keep operating as normal. Bell icon is moving on controller's display. String in the alarm list: CxCmp1 MainCode01 String in the alarm log: ± CxCmp1 MainCode01 String in the alarm snapshot CxCmp1 MainCode01	The inverter cooling valve in the inverter, may require a verification or a replacement.	Contact your service organization to get the problem solved.
Reset		Notes
Local HMI	<input checked="" type="checkbox"/>	
Network	<input checked="" type="checkbox"/>	
Auto	<input type="checkbox"/>	

5.4.7 CxCmp1 MaintCode02

This alarm indicates that a component in the inverter may require verification or even a replacement.

Symptom	Cause	Solution
Circuit status is On. The compressor keep operating as normal. Bell icon is moving on controller's display. String in the alarm list: CxCmp1 MainCode02 String in the alarm log: ± CxCmp1 MainCode02 String in the alarm snapshot	The capacitors in the inverter, may require a verification or a replacement.	Contact your service organization to get the problem solved.

CxCmp1 MainCode02

Reset	Notes
Local HMI	<input checked="" type="checkbox"/>
Network	<input checked="" type="checkbox"/>
Auto	<input type="checkbox"/>

5.4.8 Power Loss

This alarm indicates that a short under voltage on main power supply, that does not turn off the unit, has occurred.



Resolution of this fault requires a direct intervention on the power supply of this unit. Direct intervention on the power supply can cause electrocution, burns or even death. This action must be performed only by trained persons. In case of doubts contact your maintenance company.

Symptom	Cause	Solution
Circuit status is On. The controller brings the compressor to the minimum speed and then normal operation is recovered (default 1200rpm) Bell icon is moving on controller's display. String in the alarm list: Cx FanAlm String in the alarm log: ± Cx FanAlm String in the alarm snapshot Cx FanAlm	Chiller main power supply had a down peak which caused the trip.	Check if main power supply is within the acceptable tolerance for this chiller

Reset	Notes
Local HMI	<input checked="" type="checkbox"/>
Network	<input checked="" type="checkbox"/>
Auto	<input type="checkbox"/>

5.5 Circuit Pumpdown Stop Alarms

5.5.1 Discharge Temperature Sensor fault

This alarm is generated to indicate that the sensor is not reading properly.

Symptom	Cause	Solution
Circuit status is Off. The circuit is switched off with the normal shutdown procedure. Bell icon is moving on controller's display. String in the alarm list: CxCmp1 OffDischTmpSen String in the alarm log: ± CxCmp1 OffDischTmpSen String in the alarm snapshot CxCmp1 OffDischTmpSen	Sensor is shorted. Sensor is broken. Sensor is not properly connected (open).	Check for sensor integrity. Check correct sensors operation according information about kOhm (kΩ) range related to temperature values. Check if sensor is shorted with a resistance measurement. Check for correct installation of the sensor on refrigerant circuit pipe. Check for absence of water or humidity on sensor electrical contacts. Check for correct plug-in of the electrical connectors. Check for correct sensors wiring also according with electrical scheme.

Reset	Notes
Local HMI	<input checked="" type="checkbox"/>
Network	<input checked="" type="checkbox"/>
Auto	<input type="checkbox"/>

5.5.2 Gas Leakage fault

This alarm indicates a gas leakage in the compressor box.

Symptom	Cause	Solution
Circuit status is Off.	Gas leakage in the compressors box .	Switch off the unit and perform a gas leakage test.

The circuit is switched off with the shutdown procedure performing a deep pumpdown of the circuit.
Bell icon is moving on controller's display.
String in the alarm list:
Cx OffGasLeakage
String in the alarm log:
± Cx OffGasLeakage
String in the alarm snapshot
Cx OffGasLeakage

Gas Leakage in the plant room.

Check if there are leakage on the unit with a detector eventually starting suction fans to change the air in the room.

Gas leakage sensor fault.

Put the sensor in open air and check that the alarm can be cleared. In case replace the sensor or disable the option before getting a new part.

Reset

Notes

- Local HMI
- Network
- Auto

5.5.3 High Compressor Vfd Temperature fault

This alarm is generated to indicate that the Vfd temperature is too high to allow the compressor to run.

Symptom	Cause	Solution
Circuit status is Off. The circuit is switched off with the normal shutdown procedure. Bell icon is moving on controller's display. String in the alarm list: CxCmp1 VfdOverTemp String in the alarm log: ± CxCmp1 VfdOverTemp String in the alarm snapshot CxCmp1 VfdOverTemp	Cooling solenoid valve is not operating properly. Vfd Heater not properly connected.	Check electrical connection of the solenoid valve. Check refrigerant charge. Low refrigerant charge can cause overheating of the Vfd electronic. Check for obstructions in the pipe. Check if Vfd heater is switched off when the Vfd temperature increases. Check if the contactor that commands the Vfd heater can switch properly.

Reset

Notes

- Local HMI
- Network
- Auto

5.5.4 Liquid Temperature Sensor fault

This alarm is generated to indicate that the sensor is not reading properly.

Symptom	Cause	Solution
Circuit status is Off. The circuit is switched off with the normal shutdown procedure. Bell icon is moving on controller's display. String in the alarm list: CxCmp1 OffLiquidTempSen String in the alarm log: ± CxCmp1 OffLiquidTempSen String in the alarm snapshot CxCmp1 OffLiquidTempSen	Sensor is shorted. Sensor is broken. Sensor is not properly connected (open).	Check for sensor integrity. Check correct sensors operation according information about kOhm (kΩ) range related to temperature values. Check if sensor is shorted with a resistance measurement. Check for correct installation of the sensor on refrigerant circuit pipe. Check for absence of water or humidity on sensor electrical contacts. Check for correct plug-in of the electrical connectors. Check for correct sensors wiring also according with electrical scheme.

Reset

Notes

- Local HMI
- Network
- Auto

5.5.5 Low Compressor Vfd Temperature fault

This alarm is generated to indicate that the Vfd temperature is too low to allow the compressor to run safely.

Symptom	Cause	Solution
Circuit status is Off. The circuit is switched off with the normal shutdown procedure. Bell icon is moving on controller's display. String in the alarm list: CxCmp1 VfdLowTemp String in the alarm log:	Cooling solenoid valve is not operating properly. It's always open when compressor runs.	Check electrical connection of the solenoid valve. Check operation of the valve to see if it can close properly.

± CxCmp1 VfdLowTemp
String in the alarm snapshot
CxCmp1 VfdLowTemp

Vfd heater is not working.

Check operating cycles of the valve. It has a limited number of cycles.
Check if the Vfd heater is powered.

Check if the Vfd heater is commanded on when Vfd temperature is low.

Reset	Notes
Local HMI <input checked="" type="checkbox"/>	
Network <input checked="" type="checkbox"/>	
Auto <input type="checkbox"/>	

5.5.6 Low Oil Level fault

This alarm indicates that the oil level inside the oil separator has become too low to allow for a safe operation of the compressor.

This switch may not be installed on the unit because in regular operations the oil separation is always granted.

Symptom	Cause	Solution
Circuit status is Off. The circuit is switched off with the normal shutdown procedure. Bell icon is moving on controller's display. String in the alarm list: CxCmp1 OffOilLevelLo String in the alarm log: ± CxCmp1 OffOilLevelLo String in the alarm snapshot CxCmp1 OffOilLevelLo	Oil Level switch not operating correctly.	Check the cabling between switch and controller feedback and power Check if switch operates correctly. Check if digital input of the controller operates correctly.
	Check the oil charge	Verify if there is enough oil inside the circuit.

Reset	Notes
Local HMI <input checked="" type="checkbox"/>	
Network <input checked="" type="checkbox"/>	
Auto <input type="checkbox"/>	

5.5.7 Low Discharge Superheat fault

This alarm indicates that the unit has worked for too long with low discharge super heat.

Symptom	Cause	Solution
Circuit status is Off. The circuit is switched off with the shutdown procedure. Bell icon is moving on controller's display. String in the alarm list: CxCmp1 OffDishSHLo String in the alarm log: ± CxCmp1 OffDishSHLo String in the alarm snapshot CxCmp1 OffDishSHLo	EEXV is not working correctly. It's not opening enough or it's moving in the opposite direction.	Check if pump-down can be finished for pressure limit reached; Check expansion valve movements. Check connection to the valve driver on the wiring diagram. Measure the resistance of each winding, it has to be different from 0 Ohm.

Reset	Notes
Local HMI <input checked="" type="checkbox"/>	
Network <input checked="" type="checkbox"/>	
Auto <input checked="" type="checkbox"/> x 2 attempts (W/C only)	

5.5.8 Oil Pressure Sensor fault

This alarm is generated to indicate that the sensor is not reading properly.

Symptom	Cause	Solution
Circuit status is Off. The circuit is switched off with the normal shutdown procedure. Bell icon is moving on controller's display. String in the alarm list: CxCmp1 OffOilFeedPSen String in the alarm log: ± CxCmp1 OffOilFeedPSen String in the alarm snapshot CxCmp1 OffOilFeedPSen	Sensor is broken. Sensor is shorted. Sensor is not properly connected (open).	Check for sensor integrity. Check correct sensors operation according information about mVolt (mV) range related to pressure values in kPa. Check if sensor is shorted with a resistance measurement. Check for correct installation of the sensor on refrigerant circuit pipe. The transducer must be able to sense the pressure through the valve's needle. Check for absence of water or humidity on sensor electrical contacts.

Check for correct plug-in of the electrical connectors.
Check for correct sensors wiring also according electrical scheme.

Reset		Notes
Local HMI	<input checked="" type="checkbox"/>	
Network	<input checked="" type="checkbox"/>	
Auto	<input type="checkbox"/>	

5.5.9 Suction Temperature Sensor fault

This alarm is generated to indicate that the sensor is not reading properly.

Symptom	Cause	Solution
Circuit status is Off. The circuit is switched off with the normal shutdown procedure. Bell icon is moving on controller's display. String in the alarm list: CxComp1 OffSuctTempSen	Sensor is shorted.	Check for sensor integrity.
String in the alarm log: ± CxComp1 OffSuctTempSen	Sensor is broken.	Check correct sensors operation according information about kOhm (kΩ) range related to temperature values. Check if sensor is shorted with a resistance measurement.
String in the alarm snapshot CxComp1 OffSuctTempSen	Sensor is not good connected (open).	Check for correct installation of the sensor on refrigerant circuit pipe. Check for absence of water or humidity on sensor electrical contacts. Check for correct plug-in of the electrical connectors. Check for correct sensors wiring also according with electrical scheme.

Reset		Notes
Local HMI	<input checked="" type="checkbox"/>	
Network	<input checked="" type="checkbox"/>	
Auto	<input type="checkbox"/>	

5.6 Circuit Rapid Stop Alarms

5.6.1 Compressor Extension Communication Error

This alarm is generated in case of communication problems with the CCx module.

Symptom	Cause	Solution
Circuit status is Off. All circuits are stopped immediately. Bell icon is moving on controller's display. String in the alarm list: Cx OffCmpCtrlrComFail	Module has no power supply	Check the power supply from the connector on the side of the module. Check if LEDs are both green.
String in the alarm log: ± Cx OffCmpCtrlrComFail	Module address is not properly set	Check if the connector on the side is tightly inserted in the module Check if module's address is correct referring to the wiring diagram.
String in the alarm snapshot Cx OffCmpCtrlrComFail	Module is broken	Check if LED are on and both green. If BSP LED is solid red replace the module Check if power supply is ok but LEDs are both off. In this case replace the module

Reset		Notes
Local HMI	<input checked="" type="checkbox"/>	
Network	<input checked="" type="checkbox"/>	
Auto	<input type="checkbox"/>	

5.6.2 EXV Driver Extension Communication Error

This alarm is generated in case of communication problems with the EEXVx module.

Symptom	Cause	Solution
Circuit status is Off. All circuits are stopped immediately. Bell icon is moving on controller's display. String in the alarm list: Cx OffEXVCtrlrComFail	Module has no power supply	Check the power supply from the connector on the side of the module. Check if LEDs are both green.
String in the alarm log: ± Cx OffEXVCtrlrComFail	Module address is not properly set	Check if the connector on the side is tightly inserted in the module Check if module's address is correct referring to the wiring diagram.
String in the alarm snapshot Cx OffEXVCtrlrComFail	Module is broken	Check if LED are on and both green. If BSP LED is solid red replace the module Check if power supply is ok but LEDs are both off. In this case replace the module

Reset	Notes
Local HMI	<input checked="" type="checkbox"/>
Network	<input checked="" type="checkbox"/>
Auto	<input type="checkbox"/>

5.6.3 Compressor VFD Fault

This alarm indicates an abnormal condition that forced the inverter to stop.

Symptom	Cause	Solution
Circuit status is Off. The compressor does not load anymore, circuit is immediately stopped. Bell icon is moving on controller's display. String in the alarm list: CxComp1 OffVfdFault String in the alarm log: ± CxComp1 OffVfdFault String in the alarm snapshot CxComp1 OffVfdFault	Inverter is operating in an unsafe condition and for this reason the inverter must be stopped.	Check the alarm snapshot to identify the alarm code from the inverter. Contact your service organization to get the problem solved.

Reset	Notes
Local HMI	<input checked="" type="checkbox"/>
Network	<input checked="" type="checkbox"/>
Auto	<input type="checkbox"/>

5.6.4 Compressor VFD OverTemp

This alarm indicates that the Inverter temperature has exceeded a safety limits and the inverter has to be stopped in order to avoid damages to components.

Symptom	Cause	Solution
Circuit status is Off. The circuit is stopped. Bell icon is moving on controller's display. String in the alarm list: CxComp1 OffVfdOverTemp String in the alarm log: ± CxComp1 OffVfdOverTemp String in the alarm snapshot CxComp1 OffVfdOverTemp	Insufficient motor cooling Motor temperature sensor could not operate properly.	Check refrigerant charge. Check if operational envelope of the unit is respected. Check operation of the cooling solenoid valve Check the readings of the motor temperature sensor and check the Ohmic value. A correct reading should be around hundreds of Ohm at ambient temperature. Check the electrical connection of the sensor with the electronic board.

Reset	Notes
Local HMI	<input checked="" type="checkbox"/>
Network	<input checked="" type="checkbox"/>
Auto	<input type="checkbox"/>

5.6.5 Condensing Pressure sensor fault

This alarm indicates that the condensing pressure transducer is not operating properly.

Symptom	Cause	Solution
Circuit status is Off. The circuit is stopped. Bell icon is moving on controller's display. String in the alarm list: CxComp1 CondPressSen String in the alarm log: ± CxComp1 CondPressSen String in the alarm snapshot CxComp1 CondPressSen	Sensor is broken. Sensor is shorted. Sensor is not properly connected (open).	Check for sensor integrity. Check correct sensors operation according information about mVolt (mV) range related to pressure values in kPa. Check if sensor is shorted with a resistance measurement. Check for correct installation of the sensor on refrigerant circuit pipe. The transducer must be able to sense the pressure through the valve's needle. Check for absence of water or humidity on sensor electrical contacts. Check for correct plug-in of the electrical connectors. Check for correct sensors wiring also according electrical scheme.

Reset	Notes
Local HMI	<input checked="" type="checkbox"/>
Network	<input checked="" type="checkbox"/>
Auto	<input type="checkbox"/>

5.6.6 Economizer EXV Driver Error

This alarm indicates an abnormal condition of the Economizer EXV Driver.

Symptom	Cause	Solution
Circuit is stopped if the discharge temperature reach the high limit value. Bell icon is moving on controller's display. String in the alarm list: Cx EcoEXVDrvError String in the alarm log: ± Cx OffEcoEXVDrvError String in the alarm snapshot Cx OffEcoEXVDrvError	Hardware Error	Contact your service organization to get the problem solved.

Reset	Notes
Local HMI <input checked="" type="checkbox"/>	
Network <input checked="" type="checkbox"/>	
Auto <input type="checkbox"/>	

5.6.7 Economizer EXV Motor Not Connected

This alarm indicates an abnormal condition of the Economizer EXV Driver.

Symptom	Cause	Solution
Circuit is stopped if the discharge temperature reach the high limit value. Bell icon is moving on controller's display. String in the alarm list: Cx EcoEXVMotor String in the alarm log: ± Cx EcoEXVMotor String in the alarm snapshot Cx EcoEXVMotor	Valve not connected.	Referring to the wiring diagram check if the valve is correctly connected to the module.

Reset	Notes
Local HMI <input checked="" type="checkbox"/>	
Network <input checked="" type="checkbox"/>	
Auto <input type="checkbox"/>	

5.6.8 Evaporating Pressure sensor fault

This alarm indicates that the evaporating pressure transducer is not operating properly.

Symptom	Cause	Solution
Circuit status is Off. The circuit is stopped. Bell icon is moving on controller's display. String in the alarm list: CxCmp1 EvapPressSen String in the alarm log: ± CxCmp1 EvapPressSen String in the alarm snapshot CxCmp1 EvapPressSen	Sensor is broken. Sensor is shorted. Sensor is not properly connected (open).	Check for sensor integrity. Check correct sensors operation according information about mVolt (mV) range related to pressure values in kPa. Check if sensor is shorted with a resistance measurement. Check for correct installation of the sensor on refrigerant circuit pipe. The transducer must be able to sense the pressure through the valve's needle. Check for absence of water or humidity on sensor electrical contacts. Check for correct plug-in of the electrical connectors. Check for correct sensors wiring also according electrical scheme.

Reset	Notes
Local HMI <input checked="" type="checkbox"/>	
Network <input checked="" type="checkbox"/>	
Auto <input type="checkbox"/>	

5.6.9 EXV Driver Error

This alarm indicates an abnormal condition of the EXV Driver.

Symptom	Cause	Solution
Circuit status is Off. Circuit is immediately stopped. Bell icon is moving on controller's display. String in the alarm list: Cx OffEXVDrvError String in the alarm log: ± Cx OffEXVDrvError String in the alarm snapshot Cx OffEXVDrvError	Hardware Error	Contact your service organization to get the problem solved.

Reset	Notes
Local HMI <input checked="" type="checkbox"/>	
Network <input checked="" type="checkbox"/>	
Auto <input type="checkbox"/>	

5.6.10 EXV Motor Not Connected (TZ B, MP)

This alarm indicates an abnormal condition of the EXV Driver.

Symptom	Cause	Solution
Circuit status is Off. Circuit is immediately stopped. Bell icon is moving on controller's display. String in the alarm list: Cx OffEXVMotor String in the alarm log: ± Cx OffEXVMotor String in the alarm snapshot Cx OffEXVMotor	Valve not connected.	Referring to the wiring diagram check if the valve is correctly connected to the module.

Reset	Notes
Local HMI <input checked="" type="checkbox"/>	
Network <input checked="" type="checkbox"/>	
Auto <input type="checkbox"/>	

5.6.11 Fail Start Low Pressure

This alarm indicates that at the compressor start the evaporating pressure or condensing pressure is below a minimum fixed limit at compressor start.

Symptom	Cause	Solution
Circuit status is Off. The circuit is stopped. Bell icon is moving on controller's display. String in the alarm list: Cx OffStartFailEvpPrLo String in the alarm log: ± Cx OffStartFailEvpPrLo String in the alarm snapshot Cx OffStartFailEvpPrLo	Ambient temperature is too low or water temperature is too low Circuit refrigerant charge is too low	Check the operating envelope for this unit. Check refrigerant charge. Check for gas leakage with a sniffer.

Reset	Notes
Local HMI <input checked="" type="checkbox"/>	
Network <input checked="" type="checkbox"/>	
Auto <input type="checkbox"/>	

5.6.12 Fan VFD Over Current

This alarm indicates that the Inverter current has exceeded a safety limits and the inverter has to be stopped in order to avoid damages to components.

Symptom	Cause	Solution
Circuit status is Off. The circuit is stopped.	The ambient temperature is too high.	Check the unit selection to see if the unit can operate at full load.

Bell icon is moving on controller's display.
 String in the alarm list:
 CxCmp1 OffVfdOverCurr
 String in the alarm log:
 ± CxCmp1 OffVfdOverCurr
 String in the alarm snapshot
 CxCmp1 OffVfdOverCurr

Check if all fans are operating properly and are able to keep the condensing pressure at the proper level.
 Clean condenser coils to allow a lower condensing pressure.

Reset		Notes
Local HMI	<input checked="" type="checkbox"/>	
Network	<input checked="" type="checkbox"/>	
Auto	<input type="checkbox"/>	

5.6.13 High Discharge Temperature Alarm

This alarm indicates that the temperature at the discharge port of the compressor exceeded a maximum limit which may cause damages to the mechanical parts of the compressor.



When this alarm occurs compressor's crankcase and discharge pipes may become very hot. Be careful when getting in contact with the compressor and discharge pipes in this condition.

Symptom	Cause	Solution
Circuit status is Off. The compressor does not load anymore or even unload, circuit is stopped. Bell icon is moving on controller's display. String in the alarm list: CxCmp1 OffDischTmpHi String in the alarm log: ± CxCmp1 OffDischTmpHi String in the alarm snapshot CxCmp1 OffDischTmpHi	Liquid Injection solenoid valve is not operating properly.	Check the electrical connection between the controller and the liquid injection solenoid valve. Check if the solenoid coil operates properly Check if the digital output operates correctly. Check if when the liquid injection solenoid is activated the temperature can be controlled between the limits.
	Liquid injection orifice is small.	Check that the liquid injection line is not obstructed by observing the discharge temperature when it is activated.
	Discharge temperature sensor could not operate properly.	Check for proper operation of the discharge temperature

Reset		Notes
Local HMI	<input checked="" type="checkbox"/>	
Network	<input checked="" type="checkbox"/>	
Auto	<input type="checkbox"/>	

5.6.14 High Motor Current Alarm

This alarm indicates that the compressor absorbed current is exceeding a predefined limit.

Symptom	Cause	Solution
Circuit status is Off. The compressor does not load anymore or even unload, circuit is stopped. Bell icon is moving on controller's display. String in the alarm list: CxCmp1 OffMtrAmpsHi String in the alarm log: ± CxCmp1 OffMtrAmpsHi String in the alarm snapshot CxCmp1 OffMtrAmpsHi	The ambient temperature is too high or condenser water temperature is higher than the limit set on the unit.	Check the unit selection to see if the unit can operate at full load. Check if all fans are operating properly and are able to keep the condensing pressure at the proper level. Clean condenser coils to allow a lower condensing pressure Check if condenser pump is operating correctly, giving enough water flow. Clean condenser water heat exchanger.
	The wrong compressor model has been selected.	Check the compressor model for this unit.

Reset		Notes
Local HMI	<input checked="" type="checkbox"/>	
Network	<input checked="" type="checkbox"/>	
Auto	<input type="checkbox"/>	

5.6.15 High Motor Temperature Alarm

This alarm indicates that the motor temperature has exceeded the maximum temperature limit for safe operations.

Symptom	Cause	Solution
Circuit status is Off. The compressor does not load anymore or even unload, circuit is stopped. Bell icon is moving on controller's display. String in the alarm list: CxComp1 OffMotorTempHi String in the alarm log: ± CxComp1 OffMotorTempHi String in the alarm snapshot CxComp1 OffMotorTempHi	Insufficient motor cooling. Motor temperature sensor could not operate properly.	Check refrigerant charge. Check if operational envelope of the unit is respected. Check the readings of the motor temperature sensor and check the Ohmic value. A correct reading should be around hundreds of Ohm at ambient temperature. Check the electrical connection of the sensor with the electronic board.
Reset	Notes	
Local HMI	<input checked="" type="checkbox"/>	
Network	<input checked="" type="checkbox"/>	
Auto	<input type="checkbox"/>	

5.6.16 High Oil Pressure Differential Alarm

This alarm indicates that the oil filter is clogged and needs to be replaced.

Symptom	Cause	Solution
Circuit status is Off. The circuit is stopped. Bell icon is moving on controller's display. String in the alarm list: CxComp1 OffOilPrDiffHi String in the alarm log: ± CxComp1 OffOilPrDiffHi String in the alarm snapshot CxComp1 OffOilPrDiffHi	Oil filter is clogged. Oil Pressure Transducer is reading incorrectly. Condensing Pressure Transducer is reading incorrectly.	Replace oil filter. Check Oil Pressure Transducer readings with a gauge. Check Condensing Pressure Transducer readings with a gauge.
Reset	Notes	
Local HMI	<input checked="" type="checkbox"/>	
Network	<input checked="" type="checkbox"/>	
Auto	<input type="checkbox"/>	

5.6.17 High Pressure alarm

This alarm is generated in case the Condensing saturated temperature rise above the Maximum condensing saturated temperature and the control is not able to compensate to this condition. The maximum condenser saturated temperature is 68.5°C but it can decrease when the evaporator saturated temperature become negative.

In case of water cooled chillers operating at high condenser water temperature, if the Condensing saturated temperature exceeds the Maximum condenser saturated temperature, the circuit is only switched off without any notification on the screen as this condition is considered acceptable in this range of operation.

Symptom	Cause	Solution
Circuit status is Off. The compressor does not load anymore or even unload, circuit is stopped. Bell icon is moving on controller's display. String in the alarm list: CxComp1 OffCndPressHi String in the alarm log: ± CxComp1 OffCndPressHi String in the alarm snapshot CxComp1 OffCndPressHi	One or more condenser fans do not operate properly . Condenser pump may not be operating correctly Dirty or partially blocked condenser coil . Dirty condenser heat exchanger Inlet air temperature of the condenser is too high .	Check if fans protections have been activated. Check that the fans can turn freely. Check that there is not any obstacle to the free ejection of the air blown. Check if the pump can run and give the required water flow. Remove any obstacle; Clean the condenser coil using soft brush and blower. Clean the condenser heat exchanger. The air temperature measured at the inlet of the condenser may not exceed the limit indicated in the operational range (working envelope) of the chiller. Check the location where the unit is installed and check that there are no any short circuit of the hot-air blown from the fans of the same unit, or even from fans of next chillers (Check IOM for proper installation).

<p>Entering water temperature at condenser is too high .</p>	<p>Check the cooling tower operation and settings.</p>
<p>One or more condenser fan turning in wrong direction .</p>	<p>Check the three way valve operation and settings.</p>
<p>Excessive charge of refrigerant into the unit.</p>	<p>Check for correct phases sequence (L1, L2, L3) in the electrical connection of the fans.</p> <p>Check liquid sub-cooling and suction super-heat to control indirectly the correct charge of refrigerant. If necessary recover all the refrigerant to weight the entire charge and to control if the value is in line with kg indication on unit label.</p>
<p>Condensing pressure transducer could not operate properly.</p>	<p>Check for proper operation of the high pressure sensor.</p>
<p>Wrong unit configuration .</p>	<p>Check that the unit has been configured for high condenser temperature applications.</p>

Reset	Notes
Local HMI <input checked="" type="checkbox"/>	
Network <input checked="" type="checkbox"/>	
Auto <input type="checkbox"/>	

5.6.18 Low Pressure alarm

This alarm is generated in case the evaporating pressure drops below the Low Pressure Unload and the control is not able to compensate to this condition.

Symptom	Cause	Solution
<p>Circuit status is Off. The compressor does not load anymore or even unload, circuit is stopped immediately. Bell icon is moving on controller's display. String in the alarm list: CxComp1 OffEvPressLo String in the alarm log: ± CxComp1 OffEvPressLo String in the alarm snapshot CxComp1 OffEvPressLo</p>	<p>Transitory condition like a fan staging .</p>	<p>Wait until the condition is recovered by EXV control</p>
	<p>Refrigerant charge is low.</p>	<p>Check sight glass on liquid line to see if there is flash gas. Measure sub-cooling to see if the charge is correct.</p>
	<p>Protection limit not set to fit customer application.</p>	<p>Check the evaporator approach and the corresponding water temperature to evaluate the low pressure hold limit.</p>
	<p>High Evaporator Approach.</p>	<p>Clean the evaporator Check the quality of the fluid that flows into heat exchanger.</p>
	<p>Water flow into water heat exchanger is too low.</p>	<p>Check the glycol percentage and type (ethilenic or propilenic) Increase the water flow. Check that evaporator water pump is operating correctly providing the required water flow.</p>
	<p>Evaporating pressure transducer is not working properly. EEXV is not working correctly. It's not opening enough or it's moving in the opposite direction.</p>	<p>Check the sensor for proper operation and calibrate the readings with a gauge. Check if pump-down can be finished for pressure limit reached; Check expansion valve movements. Check connection to the valve driver on the wiring diagram.</p>
	<p>Water temperature is low</p>	<p>Measure the resistance of each winding, it has to be different from 0 Ohm. Increase inlet water temperature. Check the low pressure safeties settings.</p>

Reset	Notes	Reset
Local HMI <input checked="" type="checkbox"/>	<input checked="" type="checkbox"/>	
Network <input checked="" type="checkbox"/>	<input checked="" type="checkbox"/>	
Auto <input type="checkbox"/>	<input type="checkbox"/>	

5.6.19 Low Pressure Ratio Alarm

This alarm indicates that the ratio between evaporating and condensing pressure is below a limit which depends on compressor speed and guarantees the proper lubrication to compressor.

Symptom	Cause	Solution
<p>Circuit status is Off. The circuit is stopped. Bell icon is moving on controller's display. String in the alarm list: CxComp1 OffPrRatioLo</p>	<p>Compressor is not able to develop the minimum compression.</p>	<p>Check fan setpoint and settings, it could be too low . Check compressor absorbed current and discharge superheat. Compressor can be damaged.</p>

String in the alarm log:
± CxCmp1 OffPrRatioLo
String in the alarm snapshot
CxCmp1 OffPrRatioLo

Check the correct operation of suction / delivery pressure sensors.

Check the internal relief valve didn't opened during previous operation (check the unit history).

Note:

If the difference between delivery and suction pressure exceed 22bar, the internal relief valve open and need to be replaced.

Inspect the gate rotors / screw rotor for possible damages.

Check if the cooling tower or three way valves are operating correctly and properly set.

Reset		Notes
Local HMI	<input checked="" type="checkbox"/>	
Network	<input checked="" type="checkbox"/>	
Auto	<input type="checkbox"/>	

5.6.20 Maximum Number of Restart Alarm

This alarm indicates that for three consecutive times after the compressor start the evaporating pressure is under a minimum limit for too much time

Symptom	Cause	Solution
Circuit status is Off. The circuit is stopped. Bell icon is moving on controller's display. String in the alarm list: Cx OffNbrRestarts String in the alarm log: ± Cx OffNbrRestarts String in the alarm snapshot Cx OffNbrRestarts	Ambient temperature is too low	Check the operating envelope for this unit.

Reset		Notes
Local HMI	<input checked="" type="checkbox"/>	
Network	<input checked="" type="checkbox"/>	
Auto	<input type="checkbox"/>	

5.6.21 Mechanical High Pressure Alarm

This alarm is generated when the condenser pressure rises above the mechanical high pressure limit causing this device to open the power supply to all the auxiliary relays. This causes an immediate shutdown of compressor and all the other actuators in this circuit.

Symptom	Cause	Solution
Circuit status is Off. The compressor does not load anymore or even unload, circuit is stopped. Bell icon is moving on controller's display. String in the alarm list: CxCmp1 OffMechPressHi String in the alarm log: ± CxCmp1 OffMechPressHi String in the alarm snapshot CxCmp1 OffMechPressHi	One or more condenser fans do not operate properly . Condenser pump may not be operating correctly Dirty or partially blocked condenser coil . Dirty condenser heat exchanger Inlet air temperature of the condenser is too high . One or more condenser fan turning in wrong direction.	Check if fans protections have been activated. Check that the fans can turn freely. Check that there is not any obstacle to the free ejection of the air blown. Check if the pump can run and give the required water flow. Remove any obstacle; Clean the condenser coil using soft brush and blower. Clean the condenser heat exchanger. The air temperature measured at the inlet of the condenser may not exceed the limit indicated in the operational range (working envelope) of the chiller . Check the location where the unit is installed and check that there are no any short circuit of the hot-air blown from the fans of the same unit, or even from fans of next chillers (Check IOM for proper installation). Check for correct phases sequence (L1, L2, L3) in the electrical connection of the fans.

Entering water temperature at condenser is too high .	Check the cooling tower operation and settings. Check the three way valve operation and settings.
Mechanical high pressure switch is damaged or not calibrated.	Check for proper operation of the high pressure switch.

Reset		Notes
Local HMI	<input checked="" type="checkbox"/>	Reset of this alarm requires a manual action on the high pressure switch.
Network	<input checked="" type="checkbox"/>	
Auto	<input type="checkbox"/>	

5.6.22 Mechanical Low Pressure Alarm

This alarm is generated when the evaporating pressure drops below the mechanical low pressure limit causing this device to open. This causes an immediate shutdown of compressor to prevent from freezing.

Symptom	Cause	Solution
Circuit status is Off. The compressor does not load anymore or even unload, circuit is stopped. Bell icon is moving on controller's display. String in the alarm list: CxComp1 OffMechPressLo String in the alarm log: ± CxComp1 OffMechPressLo String in the alarm snapshot CxComp1 OffMechPressLo	Refrigerant charge is low.	Check sight glass on liquid line to see if there is flash gas. Measure sub-cooling to see if the charge is correct.
	High Evaporator Approach.	Clean the evaporator Check the quality of the fluid that flows into heat exchanger.
	Water flow into water heat exchanger is too low.	Check the glycol percentage and type (ethilenic or propilenic) Increase the water flow. Check that evaporator water pump is operating correctly providing the required water flow.
	Evaporating pressure transducer is not working properly. EEXV is not working correctly. It's not opening enough or it's moving in the opposite direction.	Check the sensor for proper operation and calibrate the readings with a gauge. Check if pump-down can be finished for pressure limit reached; Check expansion valve movements. Check connection to the valve driver on the wiring diagram. Measure the resistance of each winding, it has to be different from 0 Ohm.

Reset		Notes
Local HMI	<input checked="" type="checkbox"/>	
Network	<input checked="" type="checkbox"/>	
Auto	<input type="checkbox"/>	

5.6.23 No Pressure At Start Alarm

This alarm is used to indicate a condition where the pressure at the evaporator or at the condenser is lower than 35kPa, so the circuit is potentially empty of refrigerant.

Symptom	Cause	Solution
Circuit status is Off. The compressor does not start Bell icon is moving on controller's display. String in the alarm list: Cx OffNoPressAtStart String in the alarm log: ± Cx OffNoPressAtStart String in the alarm snapshot Cx OffNoPressAtStart	Evaporator or condenser pressure are below 35kPa	Check transducers calibration with an appropriate gauge. Check transducers cabling and readout.
		Check refrigerant charge and set it to the proper value.

Reset		Notes
Local HMI	<input checked="" type="checkbox"/>	
Network	<input checked="" type="checkbox"/>	
Auto	<input type="checkbox"/>	

5.6.24 No Pressure Change At Start Alarm

This alarm indicates that the compressor is not able to start or to create a certain minimum variation of the evaporating or condensing pressures after start.

Symptom	Cause	Solution
Circuit status is Off. The circuit is stopped.	Compressor cannot start	Check if the start signal is properly connected to the inverter.

Bell icon is moving on controller's display. String in the alarm list: Cx OffNoPressChgStart String in the alarm log: ± Cx OffNoPressChgStart String in the alarm snapshot Cx OffNoPressChgStart	Compressor is turning in wrong direction. Refrigerant circuit is empty of refrigerant. Not proper operation of evaporating or condensing pressure transducers.	Check correct phases sequence to the compressor (L1, L2, L3) according to the electrical scheme. Inverter is not properly programmed with the right direction of rotation Check circuit pressure and presence of refrigerant. Check proper operation of evaporating or condensing pressure transducers.
--	--	--

Reset		Notes
Local HMI	<input checked="" type="checkbox"/>	
Network	<input checked="" type="checkbox"/>	
Auto	<input type="checkbox"/>	

5.6.25 Overvoltage Alarm

This alarm indicates that chiller supply voltage exceeded the maximum limit which allows proper operations of the components. This is estimated looking at the DC voltage on the inverter which depends of course from the main power.



Resolution of this fault requires a direct intervention on the power supply of this unit. Direct intervention on the power supply can cause electrocution, burns or even death. This action must be performed only by trained persons. In case of doubts contact your maintenance company.

Symptom	Cause	Solution
Circuit status is Off. The circuit is stopped. Bell icon is moving on controller's display. String in the alarm list: Cx OffOverVoltage String in the alarm log: ± Cx OffOverVoltage String in the alarm snapshot Cx OffOverVoltage	Chiller main power supply had an up peak which caused the trip. Main power supply setting on the Microtech III is not suitable with the power supply in use .	Check if main power supply is within the acceptable tolerance for this chiller Measure the power supply to the chiller and select the proper value on the Microtech III HMI.

Reset		Notes
Local HMI	<input checked="" type="checkbox"/>	
Network	<input checked="" type="checkbox"/>	
Auto	<input checked="" type="checkbox"/>	The alarm clears automatically when the voltage is reduced to an acceptable limit.

5.6.26 Undervoltage Alarm

This alarm indicates that chiller supply voltage exceeded the minimum limit which allows proper operations of the components.



Resolution of this fault requires a direct intervention on the power supply of this unit. Direct intervention on the power supply can cause electrocution, burns or even death. This action must be performed only by trained persons. In case of doubts contact your maintenance company.

Symptom	Cause	Solution
Circuit status is Off. The circuit is stopped. Bell icon is moving on controller's display. String in the alarm list: Cx OffUnderVoltage String in the alarm log: ± Cx OffUnderVoltage String in the alarm snapshot Cx OffUnderVoltage	Chiller main power supply had a down peak which caused the trip. Main power supply setting on the Microtech III is not suitable with the power supply in use .	Check if main power supply is within the acceptable tolerance for this chiller Measure the power supply to the chiller and select the proper value on the Microtech III HMI.

Reset		Notes
Local HMI	<input checked="" type="checkbox"/>	
Network	<input checked="" type="checkbox"/>	
Auto	<input checked="" type="checkbox"/>	The alarm clears automatically when the voltage is increased to an acceptable limit.

5.6.27 VFD Communication Failure

This alarm indicates a communication problem with the inverter.

Symptom	Cause	Solution
Circuit status is Off. The compressor does not load anymore, circuit is immediately stopped. Bell icon is moving on controller's display.	RS485 network is not properly cabled.	Check the continuity of the RS485 network with the unit off. There should be continuity from the main controller to the last inverter as indicated on the wiring diagram.
String in the alarm list: CxComp1 OffVfdCommFail	Modbus communication is not running properly.	Check inverter addresses and addresses of all the additional devices in the RS485 network (for example the energy meter). All the addresses must be different.
String in the alarm log: ± CxComp1 OffVfdCommFail		Check with your service organization to evaluate this possibility and eventually replace the board.
String in the alarm snapshot CxComp1 OffVfdCommFail	Modbus interface card can be faulty	

Reset		Notes
Local HMI	<input checked="" type="checkbox"/>	The alarm clears automatically when the communication is re-established.
Network	<input checked="" type="checkbox"/>	
Auto	<input checked="" type="checkbox"/>	

6 OPTIONS

6.1 Energy Meter including Current Limit (Optional)

An energy meter can be optionally installed on the unit. The energy meter is connected through Modbus to the unit controller, which can display all relevant electrical data such as:

- Line to Line Voltage (per phase and average)
- Line Current (per phase and average)
- Active Power
- Cos Phi
- Active Energy

More details are described in chapter **Errore. L'origine riferimento non è stata trovata.** All these data can be also accessed from a BMS by connecting it to a communication module. See the communication module manual for details on the device and parameter settings.

Both the energy meter device and the unit controller need to be properly set. The instructions below detail how to set the energy meter. Refer to the specific instructions of the energy meter for more detail on the operation of the device.

Energy Meter Settings (Nemo D4-L / Nemo D4-Le)		
Password (Down+Enter)	1000	
Connection	3-2E	three phase Aron System
Address	020	
Baud	19.2	kbps
Par	None	parity bit
Time Out	3	sec
Password 2	2001	
CT ratio	see CT label	current transformer ratio (i.e if CT is 600:5, set to 120)
VT ratio	1	no voltage transformers (unless 690V chiller)

Once the energy meter has been configured, do the following steps in the unit controller:

- From Main Menu, go to View/Set Unit → Commission Unit → Configuration → Unit
- Set Energy Mtr = Nemo D4-L or Nemo D4-Le

The energy meter option integrates the current limit function, which allows the unit to limit its capacity in order not to exceed a pre-defined current setpoint. This setpoint can be set in the unit display or can be changed from an external 4-20 mA signal.

The current limit must be set according to the following instructions:

- From Main Menu, go to View/Set Unit → Power Conservation

The following settings related to current limit option are available into the menu:

Unit Current	Displays the unit current
Current Limit	Displays the active current limit (which can be given by an external signal if unit is in network mode)
Current Lim Sp	Set the current limit setpoint (if unit is in local mode)

The present publication is drawn up by of information only and does not constitute an offer binding upon Daikin Applied Europe S.p.A.. Daikin Applied Europe S.p.A. has compiled the content of this publication to the best of its knowledge. No express or implied warranty is given for the completeness, accuracy, reliability or fitness for particular purpose of its content, and the products and services presented therein. Specification are subject to change without prior notice. Refer to the data communicated at the time of the order. Daikin Applied Europe S.p.A. explicitly rejects any liability for any direct or indirect damage, in the broadest sense, arising from or related to the use and/or interpretation of this publication. All content is copyrighted by Daikin Applied Europe S.p.A..

DAIKIN APPLIED EUROPE S.p.A.

Via Piani di Santa Maria, 72 - 00040 Ariccia (Roma) - Italia
Tel: (+39) 06 93 73 11 - Fax: (+39) 06 93 74 014
<http://www.daikinapplied.eu>