

**DAIKIN**



# OPERATION MANUAL

## Wireless remote controller kit

BRC7FA532F

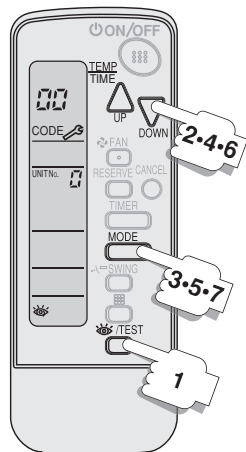
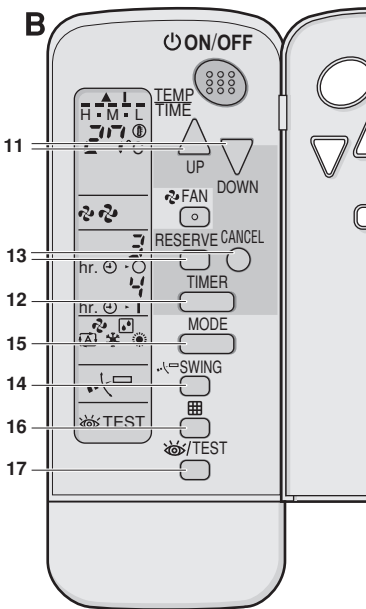
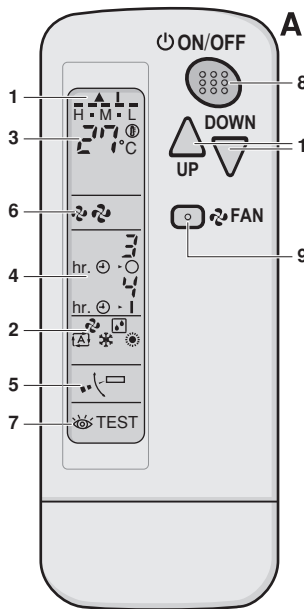

1

2

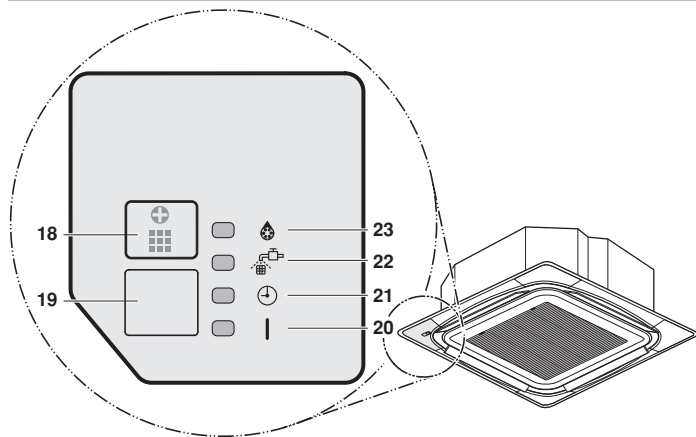

3

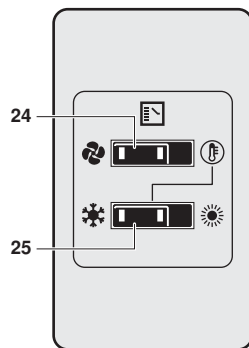

4

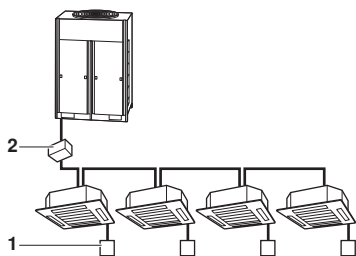

5

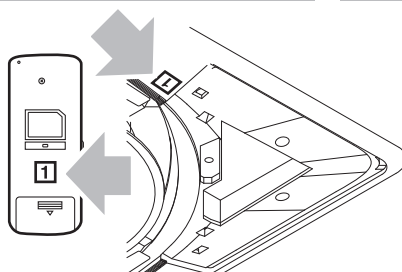

6

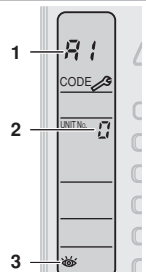

7

## CONTENTS

	Page
Safety considerations .....	1
Names and functions of the operating section .....	2
Handling for wireless remote controller .....	3
Precautions in handling remote controller .....	3
Installation site .....	3
Placing the remote controller in the remote controller holder .....	3
How to put the batteries .....	3
When to change batteries .....	3
In case of a centralized control system .....	3
Operation range .....	4
Operation procedure .....	4
Cooling, Heating, Automatic, Fan and Program dry operation .....	4
Adjustment .....	5
Program timer operation .....	6
How to set master remote controller (only for VRV system) .....	6
How to designate the master remote controller .....	7
Emergency operation .....	7
Precautions for group control system or two remote control system .....	7
How to diagnose trouble spots .....	7
Emergency stop .....	7
In case besides emergency stop .....	8
Not malfunction of the air conditioner .....	8
Disposal requirements .....	9



Thank you for purchasing this Daikin remote controller. Carefully read this operation manual before using the air conditioner. It will tell you how to use the unit properly and help you if any trouble occurs. After reading the manual, file it away for future reference.

The English text is the original instruction. Other languages are translations of the original instructions.

## SAFETY CONSIDERATIONS

To gain full advantage of the air conditioner's functions and to avoid malfunction due to mishandling, we recommend that you read this instruction manual carefully before use.

The precautions described herein are classified as WARNING and CAUTION. They both contain important information regarding safety. Be sure to observe all precautions without fail.



### WARNING

Failure to follow these instructions properly may result in personal injury or loss of life.

### CAUTION

Failure to observe these instructions properly may result in property damage or personal injury, which may be serious depending on the circumstances.

Information classified as **NOTE** contains instructions to ensure proper use of the equipment.

After reading, keep this manual in a convenient place so that you can refer to it whenever necessary. If the equipment is transferred to a new user, be sure also to hand over the manual.



### WARNING

- Be aware that prolonged, direct exposure to cool or warm air from the air conditioner, or to air that is too cool or too warm can be harmful to your physical condition and health.
- When the air conditioner is malfunctioning (giving off a burning odour, etc.) turn off power to the unit and contact your local dealer. Continued operation under such circumstances may result in a failure, electric shocks or fire hazards.
- Do not attempt to install or repair the air conditioner yourself. Improper workmanship may result in water leakage, electric shocks or fire hazards. Please contact your local dealer or qualified personnel for installation and maintenance work.
- Ask your dealer to perform servicing or repairs whenever necessary. Improper servicing or repairs may result in water leaks, electric shock or fire.
- Do not place objects, including rods, your fingers, etc., in the air inlet or outlet. Injury may result due to contact with the air conditioner's highspeed fan blades.
- Consult your local dealer regarding relocation and reinstallation of the air conditioner. Improper installation work may result in leakage, electric shocks or fire hazards.



### CAUTION

- Do not use the air conditioner for purposes other than those for which it is intended. Do not use the air conditioner for cooling precision instruments, food, plants, animals or works of art as this may adversely affect the performance, quality and/or longevity of the object concerned.
- To avoid oxygen depletion, ensure that the room is adequately ventilated if equipment such as a burner is used together with the air conditioner.
- Do not expose plants or animals directly to air flow from the unit as this may cause adverse effects.
- To avoid electric shocks, do not operate with wet hands.
- Do not place burners or heaters in places exposed to the air flow from the unit as this may impair combustion of the burner or heater.
- Do not place flammable sprays or operate spray containers near the unit as this may result in fire.

## NAMES AND FUNCTIONS OF THE OPERATING SECTION

See **figure 1**, (figure 1B shows the remote controller with front cover opened)

- 1 DISPLAY "▲" (SIGNAL TRANSMISSION)  
This lights up when a signal is being transmitted.
- 2 DISPLAY "🌀" "📺" "📺" "🌞" "🌞" (OPERATION MODE)  
This display shows the current OPERATION MODE.
- 3 DISPLAY "🌡️" (SET TEMPERATURE)  
This display shows the set temperature.
- 4 DISPLAY "hr. Ⓞ" "🕒" "hr. Ⓞ" "🕒" (PROGRAMMED TIME)  
This display shows PROGRAMMED TIME of the system start or stop.
- 5 DISPLAY "↔️" (SWING FLAP)  
Refer to "AIR FLOW DIRECTION ADJUST" on page 5.
- 6 DISPLAY "🌀" "🌀" (FAN SPEED)  
The display shows the set fan speed.
- 7 DISPLAY "🔍TEST" (INSPECTION/ TEST OPERATION)  
When the INSPECTION/TEST OPERATION BUTTON is pressed, the display shows the system mode is in.
- 8 ON/OFF BUTTON  
Press the button and the system will start. Press the button again and the system will stop.
- 9 FAN SPEED CONTROL BUTTON  
Press this button to select the fan speed, HIGH or LOW, of your choice.
- 10 TEMPERATURE SETTING BUTTON  
Use this button for SETTING TEMPERATURE (Operates with the front cover of the remote controller closed.)
- 11 PROGRAMMING TIMER BUTTON  
Use this button for programming "START and/or STOP" time. (Operates with the front cover of the remote controller opened.)
- 12 TIMER MODE START/STOP BUTTON  
Refer to "TIMER MODE START/STOP" on page 6.
- 13 TIMER RESERVE/CANCEL BUTTON  
Refer to "PROGRAMMING TIME" on page 6.
- 14 AIR FLOW DIRECTION ADJUST BUTTON  
Refer to "AIR FLOW DIRECTION ADJUST" on page 5.
- 15 OPERATION MODE SELECTOR BUTTON  
Press this button to select OPERATION MODE.

- 16 FILTER SIGN RESET BUTTON  
Refer to the section of MAINTENANCE in the operation manual attached to the indoor unit.
- 17 INSPECTION/TEST OPERATION BUTTON  
This button is used only by qualified service persons for maintenance purposes.

See **figure 3**, (receiver on decoration panel)

- 18 EMERGENCY OPERATION SWITCH  
This switch is readily used if the remote controller does not work.
- 19 RECEIVER  
This receives the signals from the remote controller.
- 20 OPERATING INDICATOR LAMP (Red)  
This lamp stays lit while the air conditioner runs. It flashes when the unit is in trouble.
- 21 TIMER INDICATOR LAMP (Green)  
This lamp stays lit while the timer is set.
- 22 AIR FILTER CLEANING TIME INDICATOR LAMP (Red)  
Lights up when it is time to clean the air filter.
- 23 DEFROST LAMP (Orange)  
Lights up when the defrosting operation has started.

See **figure 4**, (cool/heat changeover switch)

In a VRV system, the wireless remote controller can be used together with a cool/heat changeover switch.

- 24 FAN/AIR CONDITIONING SELECTOR SWITCH  
Set the switch to "🌀" (FAN) and "🌡️" (A/C) for HEAT or COOL.
- 25 COOL/HEAT CHANGEOVER SWITCH  
Set the switch to "❄️" (COOL) for COOL and "🌞" (HEAT) for HEAT

### NOTE



- For the sake of explanation, all indications are shown on the display in **figure 1** contrary to actual running situations.
- If the air filter cleaning time indicator lamp lights up, clean the air filter as explained in the operation manual provided with the indoor unit. After cleaning and reinstalling the air filter, press the filter sign reset button on the remote controller. The air filter cleaning time indicator lamp on the receiver will go out.
- The defrost lamp will flash when the power is turned on. This is not a malfunction.

## HANDLING FOR WIRELESS REMOTE CONTROLLER

### Precautions in handling remote controller

- Direct the transmitting part of the remote controller to the receiving part of the air conditioner.
- If something blocks the transmitting and receiving path of the indoor unit and the remote controller as curtains, it will not operate.

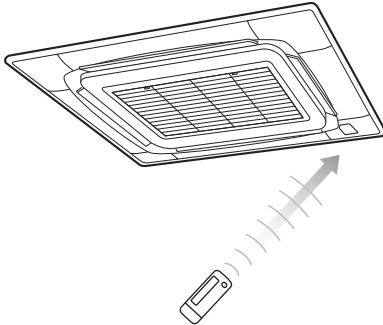

- Transmitting distance is approximately 7 m.
- 2 short beeps from the receiver indicates that the transmission is properly done.
- Do not drop or get it wet. It may get damaged.
- Never press the button of the remote controller with a hard, pointed object. The remote controller may get damaged.

### Installation site

- It is possible that signals will not be received in rooms that have electronic fluorescent lighting. Please consult with the salesman before buying new fluorescent lights.
- If the remote controller operated some other electrical apparatus, move that machine away or consult your dealer.

### Placing the remote controller in the remote controller holder

Install the remote controller holder to a wall or a pillar with the attached screw. Make sure the remote controller transmits.

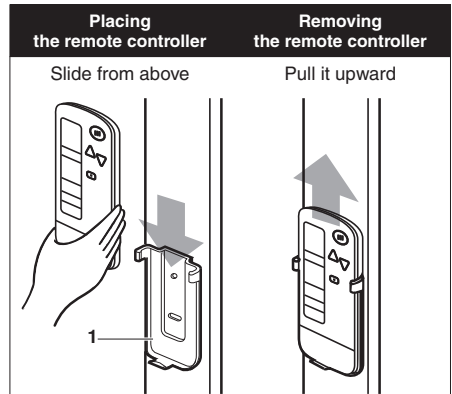

1 Remote controller holder

### How to put the batteries

- 1 Remove the back cover of the remote controller to the direction pointed by the arrow mark.
- 2 Insert the batteries. Use two alkaline batteries of type AAA.LR03. Put the batteries correctly to fit their (+) and (-). Close the cover.

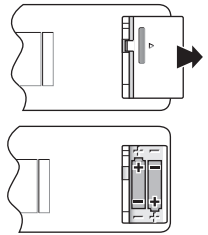

### When to change batteries

Under normal use, batteries last about a year. However, change them whenever the indoor unit doesn't respond or responds slowly to commands, or if the display becomes dark.

<b>NOTE</b> 	Replace the two batteries at the same time, do not use new and old batteries intermixed.
	In case the remote controller is not used for a long time, take out all batteries in order to prevent liquid leak of the battery.

### In case of a centralized control system

If the indoor unit is under centralized control, it is necessary to switch the remote controller's setting. In this case, contact your dealer.

## OPERATION RANGE

- Refer to the operation manual provided with the indoor unit or with the outdoor unit.
- If the indoor temperature or humidity is beyond operating conditions as listed in the indoor unit or outdoor unit manuals, it may happen
  - that safety devices work,
  - that the air conditioner does not operate,
  - that water drips from the indoor unit.
- The setting temperature range of the remote controller is 16°C to 32°C.

## OPERATION PROCEDURE

- To protect the unit, turn on the main power switch 6 hours before operation.
- If the main power supply is turned off during operation, operation will restart automatically after the power turns back on again.

## Cooling, Heating, Automatic, Fan and Program dry operation

Operate in the following order:





AUTOMATIC OPERATION can be selected only by heat pump system or heat recovery VRV system.

For systems without a cool/heat changeover remote control switch

### 1 OPERATION MODE SELECTOR

See figure 1

Press the OPERATION MODE SELECTOR button several times and select the OPERATION MODE of your choice as follows:

- COOLING operation ..... 
- HEATING operation ..... 
- AUTOMATIC operation ..... 
  - In this operation mode, COOL/HEAT changeover is automatically conducted.
- FAN operation ..... 
- DRY operation ..... 
  - The function of this program is to decrease the humidity in your room with the minimum temperature decrease.
  - The set point is the air temperature when starting operation by dry operation.
  - Micro computer automatically determines TEMPERATURE and FAN SPEED.
  - This system does not go into operation if the room temperature is below 16°C.

### 2 ON/OFF

Press ON/OFF button.  
OPERATION lamp lights up or goes off and the system starts or stops OPERATION.



Do not turn OFF power immediately after the unit stops. Then, wait no less than 5 minutes.

Water is leaking or there is something else wrong with the unit.

For systems with cool/heat changeover remote control switch

### 1 OPERATION MODE SELECTOR

See figure 4

Select OPERATION MODE with the COOL/HEAT CHANGEOVER REMOTE CONTROL SWITCH as follows.

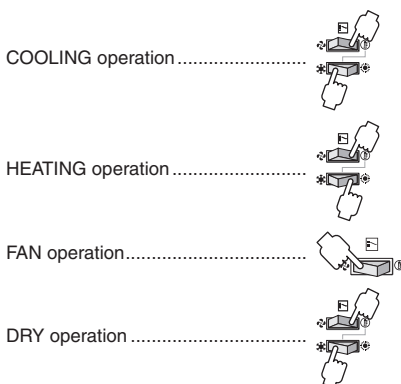

Press OPERATION MODE SELECTOR button several times and select "  ".

See "For systems without a cool/heat changeover remote control switch" on page 4 for details on dry operation.

(This operation is only available during dry operation.)

### 2 ON/OFF

Press ON/OFF button.  
OPERATION lamp lights up or goes off and the system starts or stops OPERATION.



Do not turn OFF power immediately after the unit stops. Then, wait no less than 5 minutes.

Water is leaking or there is something else wrong with the unit.

Explanation of heating operation  
Defrost operation

- As the frost on the coil of an outdoor unit increase, heating effect decreases and the system goes into DEFROST OPERATION.
- The fan operation stops and the DEFROST lamp of the indoor unit goes on.  
After 6 to 8 minutes (maximum 10 minutes) of DEFROST OPERATION, the system returns to HEATING OPERATION.

**Heating capacity and outdoor air temperature**

- Heating capacity drops as outdoor air temperature lowers. If feeling cold, use another heater at the same time as this air conditioner.
- Hot air is circulated to warm the room. It will take some time from when the air conditioner is first started until the entire room becomes warm. The internal fan automatically turns at low speed until the air conditioner reaches a certain temperature on the inside. In this situation, all you can do is wait.
- If hot air accumulates on the ceiling and feet are left feeling cold, it is recommended to use a circulator. For details, contact the place of purchase.

**Adjustment**

For programming TEMPERATURE, FAN SPEED and AIR FLOW DIRECTION, follow the procedure shown below.

 **TEMPERATURE SETTING**

Press TEMPERATURE SETTING button and program the setting temperature.



UP

Each time this button is pressed, setting temperature rises 1°C.



DOWN

Each time this button is pressed, setting temperature lowers 1°C.

**In case of automatic operation**



UP

Each time this button is pressed, setting temperature shifts to "H" side.



DOWN

Each time this button is pressed, setting temperature shifts to "L" side.

	°C				
	H	•	M	•	L
Setting temperature	25	23	22	21	19

• The setting is impossible for fan operation

- The setting temperature range of the remote controller is 16°C to 32°C.



**FAN SPEED CONTROL**

Press FAN SPEED CONTROL button.

- High, Medium or Low fan speed can be selected.
- The micro computer may sometimes control the fan speed in order to protect the unit.



**AIR FLOW DIRECTION ADJUST**

The movable limit of the flap is changeable. Contact your dealer for details.

- Up and down adjustment

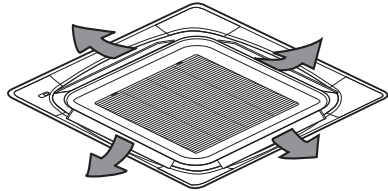

Press the AIR FLOW DIRECTION ADJUST button to select the air direction as shown below.



Display appears and the air flow direction continuously varies. (Automatic swing setting.)



Press AIR FLOW DIRECTION ADJUST button to select the air direction of your choice.

Display vanishes and the air flow direction is fixed. (Fixed air flow direction setting.)

- Movement of the swing flap  
For the following conditions, the micro computer controls the air flow direction so it may be different from the display.

Operation mode	Heating
Operation conditions	<ul style="list-style-type: none"> <li>■ When starting operation.</li> <li>■ When room temperature is higher than the set temperature.</li> <li>■ At defrost operation. (The flaps blow horizontally to avoid blowing cold air directly on the occupants of the room.)</li> </ul>

**NOTE**



- If you try cooling or programmed drying, while the flaps are facing downward, air flow direction may change unexpectedly. There is nothing wrong with the equipment. This serves to prevent dew formed on parts in the air discharge outlet from dripping.

- Operation mode includes automatic operation.

## Program timer operation

Operate in the following order.

- The timer is operated in the following two ways:
  - Programming the stop time (⊕ ▶ ○).
  - The system stops operating after the set time has elapsed.
  - Programming the start time (⊕ ▶ |).
  - The system starts operating after the set time has elapsed.
- The timer can be programmed for a maximum of 72 hours.
- The start and the stop time can be simultaneously programmed.

### 1 TIMER MODE START/STOP

Press the **TIMER MODE START/STOP** button several times and select the mode on the display. The display flashes.

- For setting the timer stop ..... ⊕ ▶ ○
- For setting the timer start ..... ⊕ ▶ |

### 2 PROGRAMMING TIME

Press the **PROGRAMMING TIME** button and set the time for stopping or starting the system.

 When this button is pressed, the time advances by 1 hour.

UP

 When this button is pressed, the time goes backward by 1 hour.

DOWN

### 3 TIMER RESERVE

Press the **TIMER RESERVE** button.

- The timer setting procedure ends.
- The display or changes from flashing light to a constant light.

4

CANCEL



TIMER CANCEL

Press the **CANCEL** button to cancel programming. The display vanishes.

*For example.*

When the timer is programmed to stop the system after 3 hours and start the system after 4 hours, the system will stop after 3 hours and then 1 hour later the system will start.

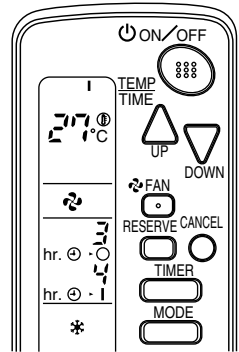

**NOTE**



After the timer is programmed, the display shows the remaining time.

## How to set master remote controller (only for VRV system)

(See figure 5)

When the system is installed as shown below, it is necessary to designate the master remote controller.

- For Heat pump system
    - When one outdoor unit is connected with several indoor units.
  - For Heat recovery system
    - When one BS unit is connected with several indoor units.
- 1 One of these remote controllers needs to be designated as the master remote controller.
  - 2 BS unit (for Heat recovery system only)
- Only the master remote controller can select HEATING, COOLING or AUTOMATIC (only Heat recovery system) OPERATION.
  - When the indoor unit with master remote controller is set to "COOL", you can switch over operation mode between "FAN", "DRY" and "COOL".
  - When the indoor unit with master remote controller is set to "HEAT", you can switch over operation mode between "FAN" and "HEAT".
  - When the indoor unit with master remote controller is set to "FAN", you cannot switch operation mode.
  - When attempting settings than that consented above, a "peep" is emitted as a warning.
  - You cannot set the indoor unit to AUTOMATIC, except with a VRV heat recovery system.



## How to designate the master remote controller

Operate in the following order.

1



Continuously press the OPERATION MODE SELECTOR button for 4 seconds.

The displays showing "⌚" of all slave indoor units connected to the same outdoor unit or BS unit flash.

2



Press the OPERATION MODE SELECTOR button to the indoor unit that you wish to designate as the master remote controller. Then designation is completed. This indoor unit is designated as the master the remote controller and the display showing "⌚" vanishes.

To change settings, repeat steps 1 and 2.

## Emergency operation

When the remote controller does not work due to battery failure or the absence thereof, use the switch which is located beside the discharge grille on the indoor unit.

When the remote controller does not work, but the battery low indicator on the remote controller is not lit, contact your dealer.

1

### START

To press the emergency operation switch.

- The machine runs in the previous mode.
- The system operates with the previously set air flow direction.

2

### STOP

Press the emergency operation switch again.

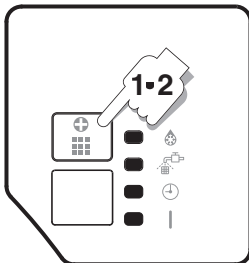

## Precautions for group control system or two remote control system

This system provides two other control systems beside individual control (one remote controller controls one indoor unit) system. Confirm the following if your unit is of the following control system type:

- Group control system  
One remote controller controls up to 16 indoor units. All indoor units are equally set.
- Two remote controller control system  
Two remote controllers control one indoor unit. (In case of group control system, one group of indoor units.)  
The unit follows individual operation.

### NOTE



- Cannot have a two remote controller control system with only wireless remote controllers. (It will be a two remote controller control system having one wired remote controller and one wireless remote controller.)
- Under two remote controller control system, wireless remote controller cannot control timer operation.
- Only the operating indicator lamp out of 3 other lamps on the indoor unit display functions

Contact your dealer in case of changing the combination or setting of group control and two remote controller control systems.

## HOW TO DIAGNOSE TROUBLE SPOTS

### Emergency stop

(See figure 2)

When the air conditioner stops in emergency, the operation lamp on the indoor unit starts blinking.

Take the following steps yourself to read the malfunction code that appears on the display. Contact your dealer with this code. It will help pinpoint the cause of the trouble and speeding up the repair.

1



Press the INSPECTION/TEST button to select the inspection mode "⌚". "⌚" appears on the display and blinks. "UNIT" lights up.

2



Press PROGRAMMING TIMER button and change the unit number.

Press to change the unit number until the indoor unit beeps and perform the following operation according to the number of beeps:

#### Number of beeps

- 3 short beeps.....perform all steps from 3 to 6
- 1 short beep .....perform 3 and 6 steps
- 1 long beep .....normal state

### 3

Press OPERATION MODE SELECTOR button.  
"U" on the left-hand of the malfunction code blinks.

### 4

Press PROGRAMMING TIMER button and change the malfunction code.  
Press until the indoor unit beeps twice.

### 5

Press OPERATION MODE SELECTOR button .  
"U" on the right-hand of the malfunction code blinks.

### 6

Press PROGRAMMING TIMER button and change the malfunction code.  
Press until the indoor unit makes a long beep.  
The malfunction code is fixed when the indoor unit makes a long beep.

### 7 Reset of the display.

Press OPERATION MODE SELECTOR button to get the display back to its normal state.

## In case besides emergency stop

- The unit does not operate at all.
  - Check if the receiver is exposed of sunlight or strong light. Keep receiver away from light.
  - Check if there are batteries in the remote controller. Place the batteries.
  - Check if the indoor unit number and wireless remote controller number are equal. See [figure 6](#). Operate the indoor unit with the remote controller of the same number.  
Signals transmitted from a remote controller of a different number cannot be accepted. (If the number is not mentioned, it is considered as "1".)
- The system operates but it does not sufficiently cool or heat.
  - If the set temperature is not proper.
  - If the FAN SPEED is set to LOW SPEED.
  - If the air flow angle is not proper.

Contact the place of purchase in the following case.



When you detect a burning odor, shut OFF power immediately and contact the place of purchase. Using the equipment in anything but proper working condition can result in equipment damage, electric shock and/or fire.

## Trouble

The RUN lamp of the indoor unit is flashing and the unit does not work at all. See [figure 7](#).

- Malfunction code
- Unit No. which sensed trouble
- INSPECTION display

## Remedial action

Check the malfunction code (*R I-UF*) on the remote controller.

Notify and inform the model name and what the malfunction code indicates to your dealer.

## NOT MALFUNCTION OF THE AIR CONDITIONER

The following symptoms do not indicate air conditioner malfunction:

### Symptom 1: The system does not operate

Example	Reason
The system does not restart immediately after the ON/OFF button is pressed.	If the OPERATION lamp lights, the system is in normal condition. It does not restart immediately because a safety device operates to prevent overload of the system. After 3 minutes, the system will turn on again automatically.
The system does not restart immediately when TEMPERATURE SETTING button is returned to the former position after pushing the button.	It does not restart immediately because a safety device operates to prevent overload of the system. After 3 minutes, the system will turn on again automatically.
If the reception beep is rapidly repeated 3 times (It sounds only twice when operating normally.)	Control is set to the optional controller for centralized control.
If the defrost lamp on the indoor unit's display is lit when heating is started.	This indication is to warn against cold air being blown from the unit. There is nothing wrong with the equipment.
The outdoor unit stops.	Because the room temperature reaches to the set temperature. The indoor unit goes into fan operation.

**Symptom 2: The unit stops once in a while**

Example	Reason
The remote controller indicates "U4" and "U5", the unit stops. Within several minutes the unit restarts.	Due to electrical noise other than that from the air conditioner, the communication between the units is cut off and the unit stops. When the noise is gone, the unit automatically restarts.

**Symptom 3: No changeover is available between heating and cooling modes**

Example	Reason
The indoor unit makes a "PEEE" receiving sound.	When operation changeover is under control, the control is set to the mode that cannot be carried out.

**Symptom 4: Air flow rate cannot be obtained as set**

Example	Reason
Even if the air flow rate adjusting button is pressed, the air flow rate does not change.	When the room temperature reaches the indoor unit set temperature, the outdoor unit stops and the air flow rate of indoor unit drops to the minimum. This is to avoid the cold air from getting in contact with the people in the room.

**Symptom 5: Air discharge direction is not as set**

Example	Reason
The remote controller indication and the air discharge direction is not the same. Air discharge direction swing is impossible.	Because it is controlled by microcomputer. Refer to " <a href="#">AIR FLOW DIRECTION ADJUST</a> " on <a href="#">page 5</a> .

**Symptom 6: Only a part of indication shows**

Example	Reason
Even if the unit is operated, only the operation indication shows, or even if the indication shows, soon after, the indication other than that for operation disappears.	The corresponding indoor unit is that for multi-system and the remote controller is set to the multi-system.

**Symptom 7: No indication shows or all indication show**

Example	Reason
When the remote controller button is pressed.	The battery is dead.

**Symptom 8: Insufficient cooling**

Example	Reason
It is in program dry operation.	The program dry operation is an operation mode trying to keep the room temperature constant as much as possible. Refer to " <a href="#">Cooling, Heating, Automatic, Fan and Program dry operation</a> " on <a href="#">page 4</a> .

**DISPOSAL REQUIREMENTS**

Batteries supplied with the remote controller are marked with this symbol.

This means that the batteries shall not be mixed with unsorted household waste.

If a chemical symbol is printed beneath the symbol, this chemical symbol means that the battery contains a heavy metal above a certain concentration. Possible chemical symbols are:

■ Pb: lead (>0.004%)

Waste batteries must be treated at a specialized treatment facility for re-use.

By ensuring waste batteries are disposed of correctly, you will help to prevent potential negative consequences for the environment and human health.



\*4PW72923-1 000000A\*

Copyright 2012 Daikin

**DAIKIN EUROPE N.V.**

Zandvoordestraat 300, B-8400 Oostende, Belgium

4PW72923-1 01.2012