

EWYD 4Z-B

Multipurpose unit with
inverter driven single
screw compressor

Product manual



Nominal capacity range 400 – 800 kW
Full Inverter Technology
2 sound configurations
Best performances at full load and part load
Design for commercial and industrial applications

Refrigerant: 134a

Code	CSS release 10.34
Date	December 2021

A single system to provide COOLING and HEATING

DAIKIN 4Z multipurpose system is the result of careful design, aimed to optimize the efficiency and functionalities bringing down the operating costs. The units' design features are high efficient single screw Inverter driven compressors, optimized refrigerant circuit, new performant fans and "shell & tube" heat exchangers for both cold and hot loops.

The EWYD~4Z range comes in one high efficiency level allowing a flexible selection. According to the specific needs, it is possible to optimize the performances or to reduce the cost per kilowatt increasing the efficiency.

In addition to the **standard** a **reduced sound** configuration is available: the noise attenuation is due to decreased fans' speed and compressors' soundproof cabinet especially designed to minimize the sound emissions, enhanced insulations on refrigerant pipe and special connections at the suction of each compressor to reduce drastically the vibrations transmission.

An extensive list of mechanical, electrical, control and installation related options is available.

Outstanding reliability DAIKIN 4Z units have two truly independent refrigerant circuits to assure maximum safety for any maintenance, whether planned or not. They are equipped with rugged compressors designed with advanced composite material gate rotors, an advanced control logic and fully in factory run-tested to ensure trouble-free operations.

Inverter stepless regulation plus variable volume ratio control A multipurpose unit provides chilled and hot water all year round facing variable climatic conditions, operating both in "Air to Water" and in "Water to Water" modes according to the plant needs. This together with the plant loads fluctuation makes the operating conditions of the compressors extremely variable. For these reasons DAIKIN Inverter Single Screw Compressor with Variable Volume Ratio Technology is the perfect technology for the 4Z multipurpose units. Inverter drive modulates unit' capacity at part load in the most efficient way, while VVR (Variable Volume Ratio) adjusts compressor operations at any condition. More in detail, sliding valves adjust refrigerant discharge pressure to the operating condensing pressure. In this way the refrigerant is compressed to the right pressure level reducing at the minimum the typical energy losses of standard compressors designed with fixed volume ratio.

Inverter drive for capacity control and VVR for pressure ratio fine-tuning are working together synergistically to optimize unit efficiency at any operating condition.

Dynamic System Management A superior software logic has been developed to get the highest efficiency at whichever operating condition. DAIKIN 4Z controls its two circuits always looking for the most efficient combination between "Air to Water" and "Water to Water" mode.

Superior control logic The MicroTech 4 controller provides an easy to use control environmental. The control logic is designed to provide maximum efficiency, to continue operation in unusual operating conditions and to provide a history of unit operation. One of the greatest benefits is the easy interface with LonWorks, Bacnet, Ethernet TCP/IP or Modbus communications. Integrated sequencing control is provided allowing to connect units (up to 4) operating as a single bigger chiller.

Quick comfort conditions and low water content required from the unit The ability of varying the output power in direct relation to the cooling and heating requirements of the system, allows to reach the set-point conditions very quickly. Also, the switches between the different operating modes occur in less than one minute allowing to operate properly with the same amount of water as in the loop of a cooling only inverter chiller.

Seasonal quietness Very low sound levels at part load conditions are achieved by modulating the fans' speed and especially thanks to the variation of compressors frequency which ensures the minimum sound level at all the time. During the "Water to Water" operation, the unit stops completely the fans reducing even more the sound emissions.

NO starting current No current spikes at start-up. The starting current is always lower than current absorbed in the maximum operating conditions (FLA).

Displacement power factor always > 0.95 The EWYD~4Z range can operate always with a displacement power factor > 0.95, which allows building owners to avoid power factor penalties and to decrease electrical losses in cable and transformers.

Code requirements – Safety and observant of laws/directives Units are designed and manufactured in accordance with applicable selections of the following.

Certifications Units are CE marked, complying with European directives in force, concerning manufacturing and safety. On request units can be produced complying with laws in force in non-European countries (ASME, GOST, etc.) and with other applications, such as the naval (RINA, etc.).

- Construction of pressure vessel 2014/68/EU
- Machinery Directive 2006/42/EC
- Low Voltage 2014/35/EU
- Electromagnetic Compatibility 2014/30/EU
- Electrical & Safety codes EN 60204-1
- Manufacturing Quality Standards UNI – UNI EN ISO 14001

Additional information related to F-GAS Regulation (EU) No 517/2014 OF THE European Parliament and of the Council of 16 April 2014 on fluorinated greenhouse gases and repealing Regulation (EC) No 842/2006

Unit model	Refrigerant type	Refrigerant GWP	N. of circuits	Refrigerant charge circuit 1 [kg]	Refrigerant charge circuit 1 [equivalent Co2 tons]	Refrigerant charge circuit 2 [kg]	Refrigerant charge circuit 2 [equivalent CO ₂ tons]
EWYD4004ZXSB2	R134a	1430	2	92	132	106	152
EWYD4504ZXSB2	R134a	1430	2	94	134	113	162
EWYD5004ZXSB2	R134a	1430	2	100	143	100	143
EWYD5504ZXSB2	R134a	1430	2	110	157	109	156
EWYD6004ZXSB2	R134a	1430	2	116	166	131	187
EWYD6504ZXSB2	R134a	1430	2	130	186	130	186
EWYD7004ZXSB2	R134a	1430	2	164	235	164	235
EWYD8004ZXSB2	R134a	1430	2	177	253	177	253

Unit model	Refrigerant type	Refrigerant GWP	N. of circuits	Refrigerant charge circuit 1 [kg]	Refrigerant charge circuit 1 [equivalent Co2 tons]	Refrigerant charge circuit 2 [kg]	Refrigerant charge circuit 2 [equivalent CO ₂ tons]
EWYD4004ZXR2	R134a	1430	2	93	133	113	162
EWYD4504ZXR2	R134a	1430	2	91	130	116	166
EWYD5004ZXR2	R134a	1430	2	112	160	112	160
EWYD5504ZXR2	R134a	1430	2	113	162	113	162
EWYD6004ZXR2	R134a	1430	2	120	172	128	183
EWYD6504ZXR2	R134a	1430	2	130	186	130	186
EWYD7004ZXR2	R134a	1430	2	160	229	160	229
EWYD8004ZXR2	R134a	1430	2	174	249	174	249

Note: Equipment contains fluorinated greenhouse gases. Actual refrigerant charge depends on the final unit construction, details can be found on the unit labels.

DAIKIN 4Z: The Multipurpose Technology

Multipurpose classification

There are two different kind of multipurpose units classified according to the application. The Eurovent certification program uses on the following classification.

2+2 pipe:

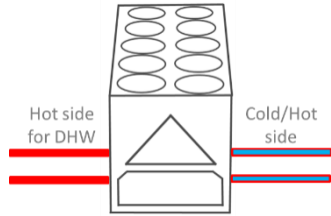

For seasonal comfort cooling/heating + production of domestic hot water

Typical use in residential application

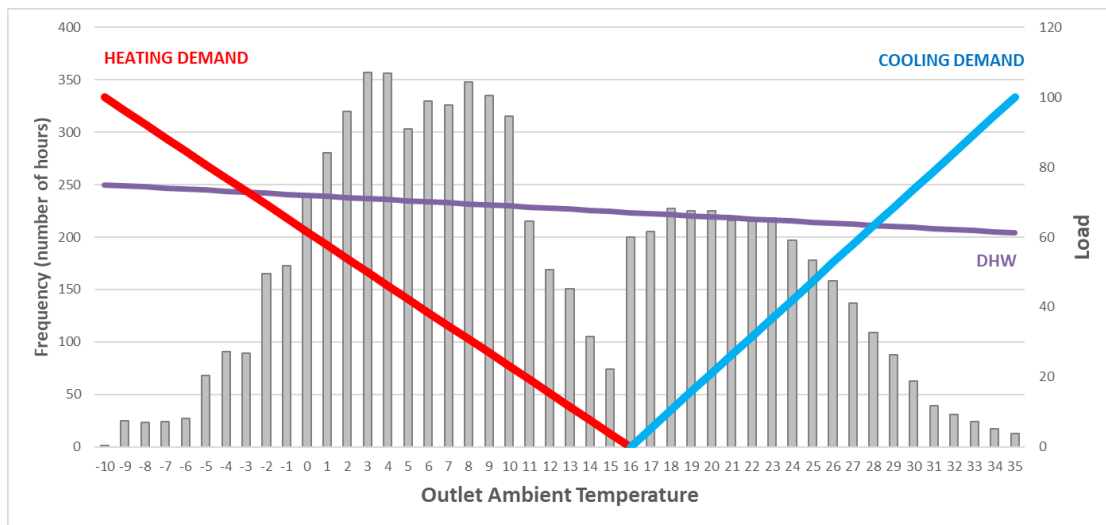

4 pipes:

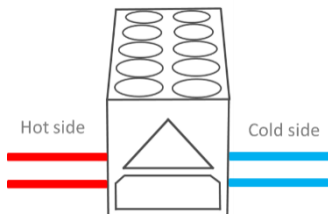

For annual comfort cooling and heating

Industrial and commercial application

4Z is this kind of 4 pipe multipurpose unit.

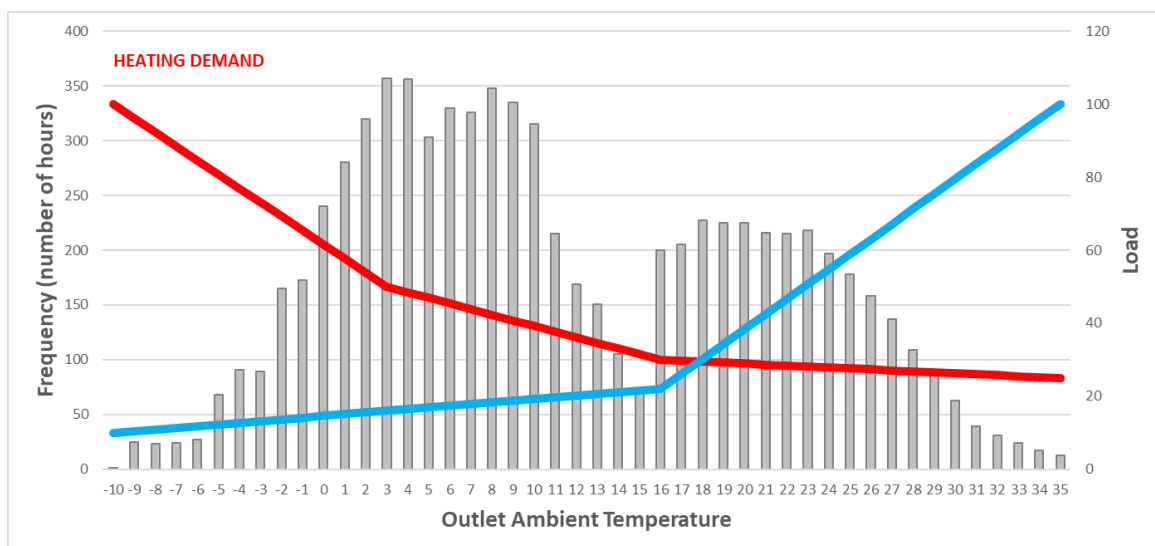

The multipurpose technology is suitable for application when there is a request for cooling and heating energy, often at the same time, during all the year. If compared to the traditional application with reversible heat pump, the main difference is that cooling and heating are required at the same time on different water loops regardless the season. The multipurpose unit does not need a seasonal changeover as the reversible heat pumps and it is able to control the two refrigerant circuits independently according to the actual demand for cooling and heating. The unit will recover cooling or heating energy whenever is possible to ensure the lower power consumption.

Below a typical annual load profile for a multipurpose application.

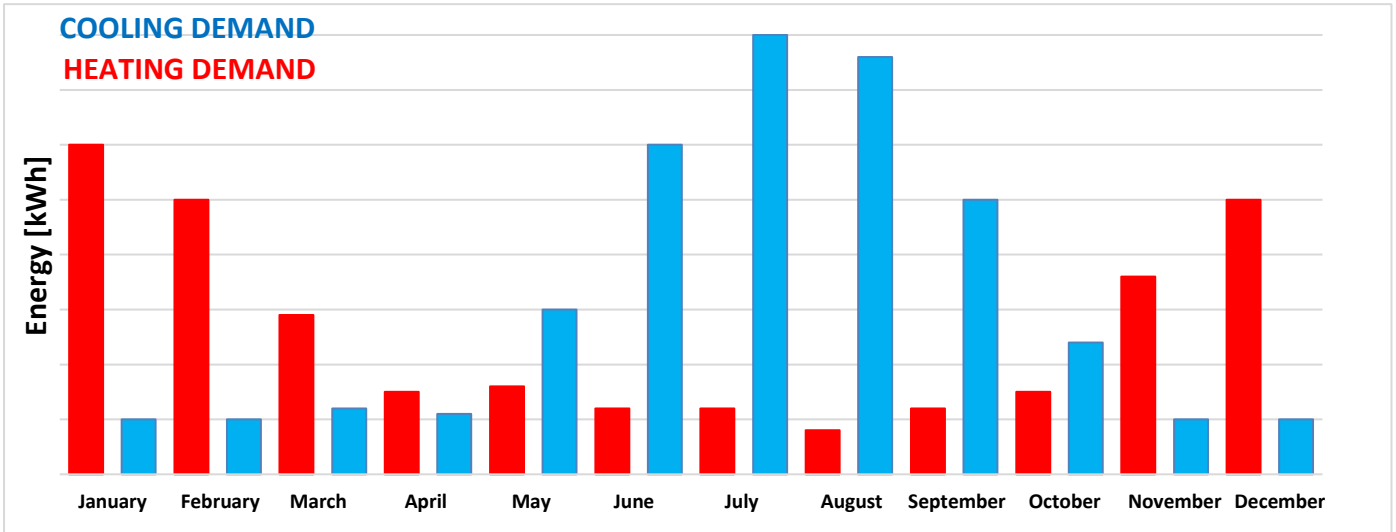

Exploiting the contemporary request for cooling and heating, DAIKIN 4Z can recover cooling or heating energy according to the operating conditions.

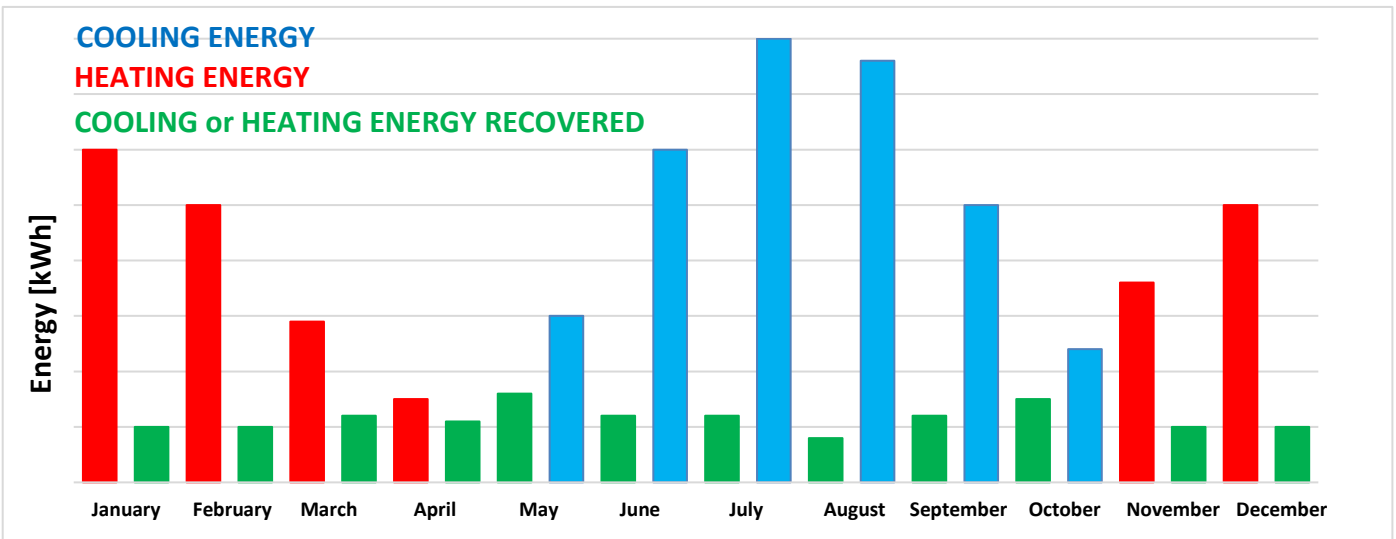

EWYD-4Z: How does it works

DAIKIN 4Z is provided with two Shell & Tube heat exchangers on water side: one operating always as evaporator (cold heat exchanger) and the other one always as condenser (hot heat exchanger). The fins & tubes Cu/Al coils are used to reject the exceeding cooling or heating energy.

Below the functional scheme of 4Z.

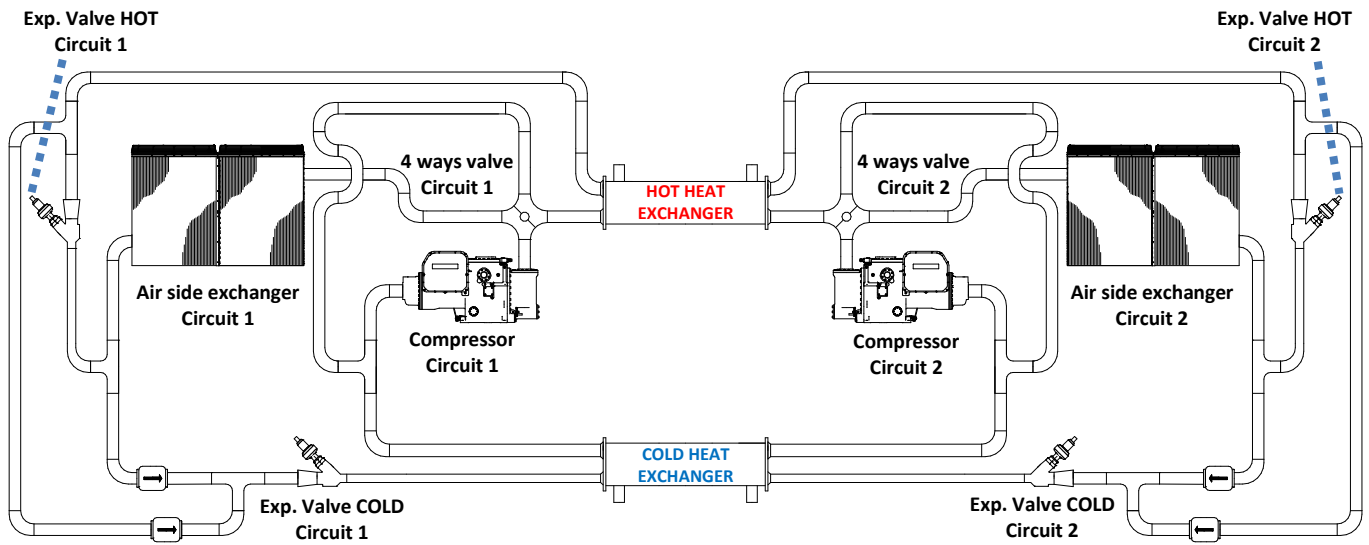

According to the variation of cooling and heating during the year, there are five possible situations that can occur:

1. Request for Cooling only

The 4Z unit operates as a chiller providing only chilled water while the hot heat exchanger is OFF and the heating energy is rejected to the air.

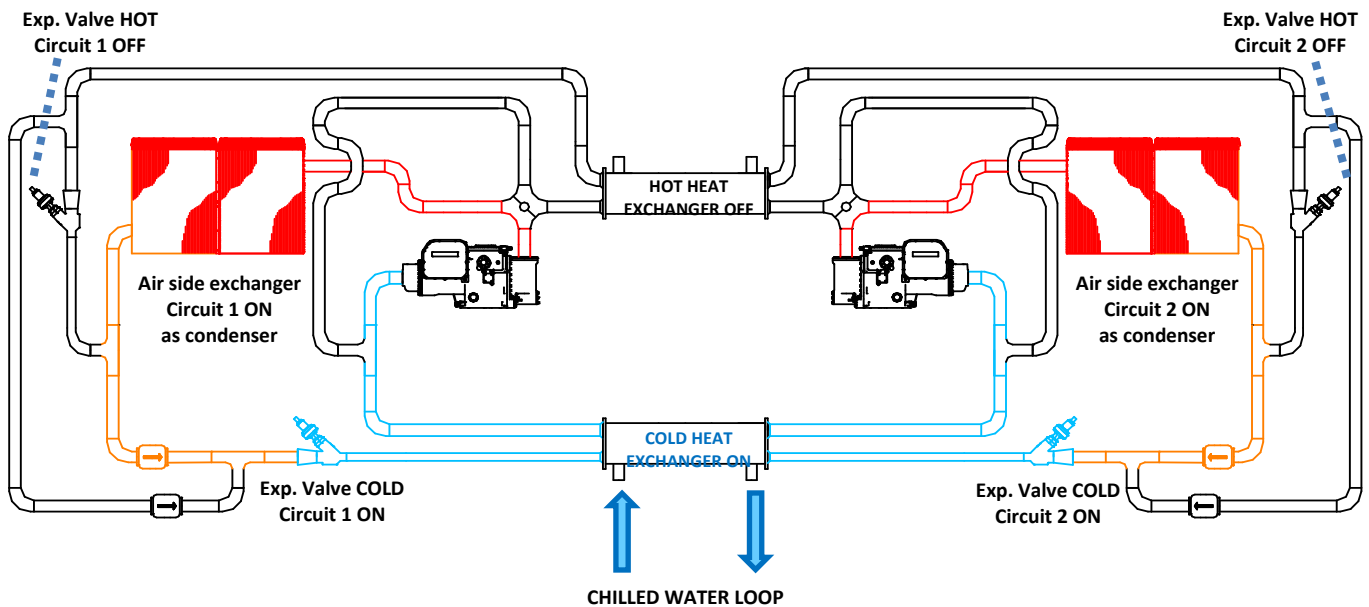

2. Request for Cooling > Heating

In this case, a circuit operates in water to water mode providing the heating load and part of the cooling load while the other circuit provides the remaining part of cooling load operating in air to water mode and the exceeded heating energy is rejected to the air.

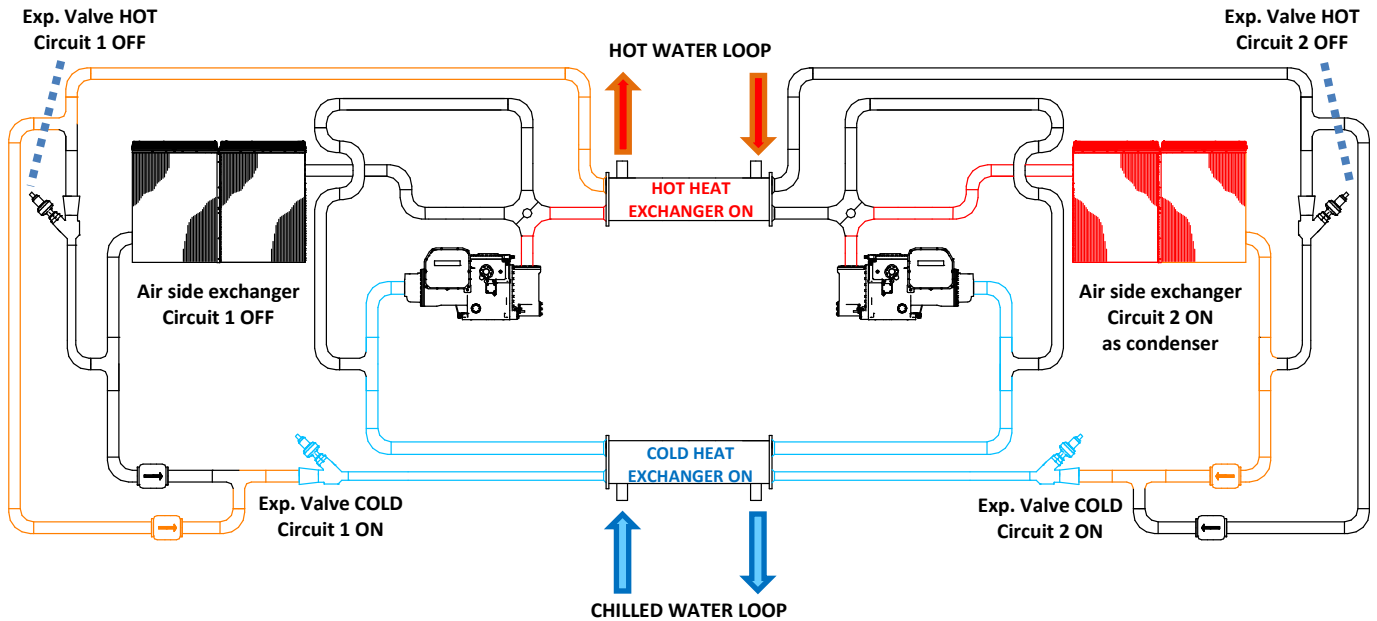

3. Request for Cooling ≈ Heating

The unit operates only in water to water mode providing chilled and hot water while the air side Heat Exchanger is OFF.

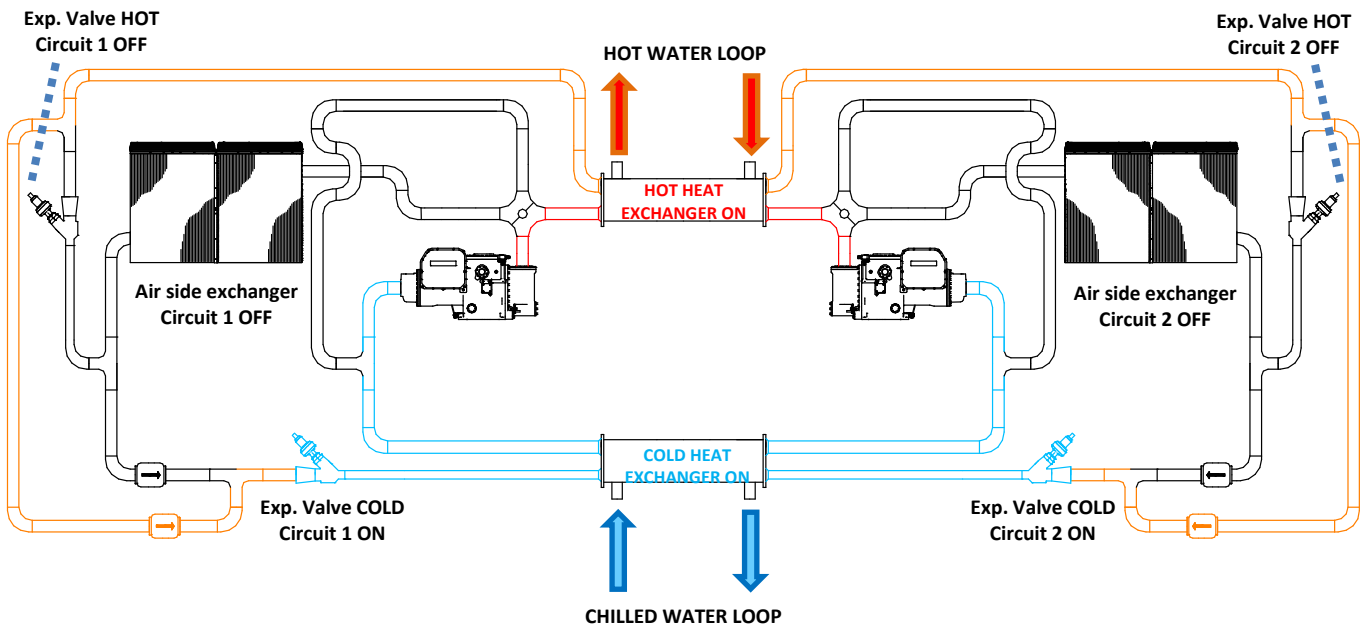

4. Request for Cooling < Heating

In this case, a circuit operates in water to water mode providing the cooling load and part of the heating load; the other circuit provides the remaining part of heating load operating in air to water mode while the exceeded cooling energy is rejected to the air.

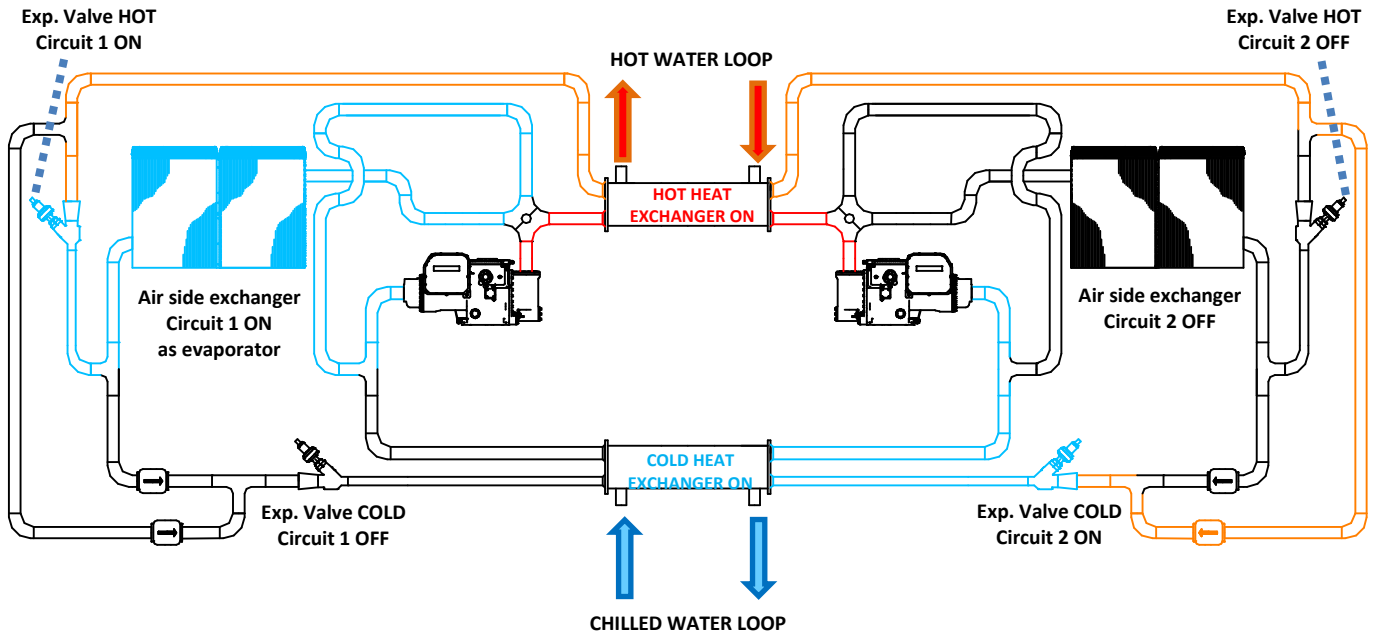

5. Request for Heating only

The 4Z operates as a heat pump providing only hot water while the Cold Heat Exchanger is OFF and the Cooling energy is rejected to the air.

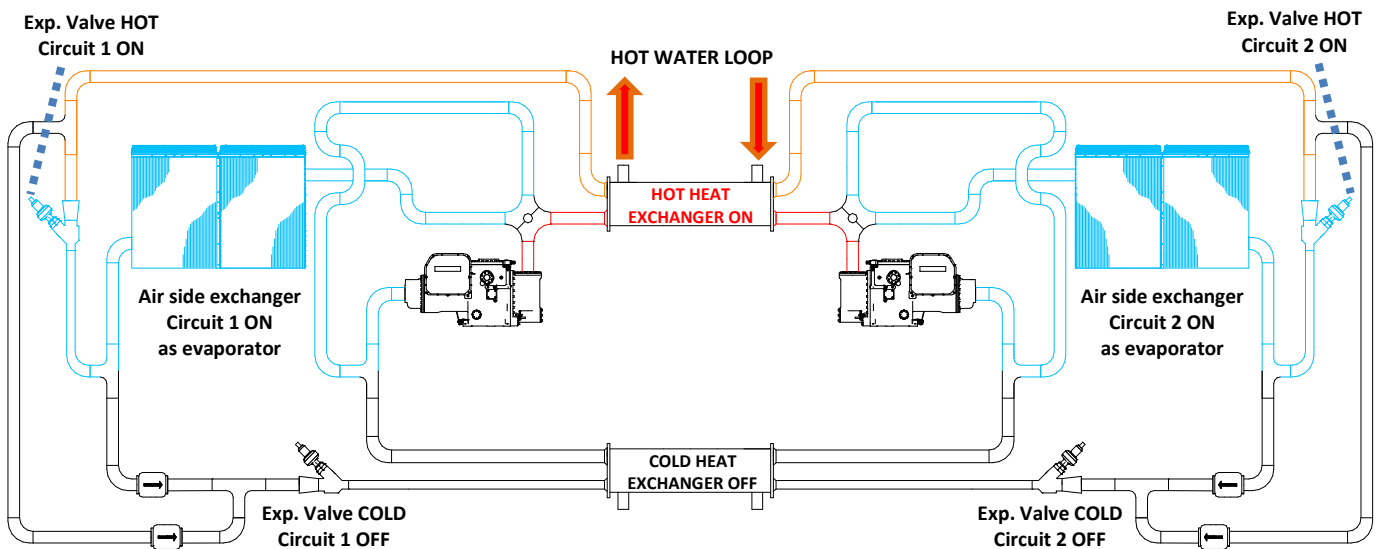

DAIKIN 4Z: Technology

During the last years, DAIKIN strategy has been based on developing technology for chillers and heat pumps focusing on efficiency, especially looking at part load operation. This made possible for Daikin to achieve the highest level of efficiency in screw chillers market. Daikin’s chiller technology is a combination of several components (compressor, fans, controls), each one carefully designed looking at the final product performances.

The key component developed by DAIKIN is the Single Screw Compressor.



Single screw compressor with Inverter and Variable Volume Ratio technology

DAIKIN 4Z is equipped with the latest technology of single screw compressors. Thanks to the careful design, result of years of experience, the single screw compressor by DAIKIN has highly balanced mechanical loads resulting in reduced stress for the components, extending the useful life and improving reliability. Vibration and sound emissions are also reduced. The superior volumetric efficiency, typical of single screw compressors, makes them an ideal solution for variable speed applications. The whole geometry of the compressor is optimized for variable speed operation even at high rotational speed.

Thanks to the Inverter technology, 4Z can match the actual load required from the plant on both cold and hot loop in any circumstance continuously modulating the compressor’s speed motor, which is the most efficient way to perform the capacity control of the compressor.

Compared to a screw compressor with mechanical unloading the resulting efficiency at part load condition (the most frequent condition) is much higher.

Other benefits of Inverter are:

- Reduced mechanical stress
- Higher displacement power factor
- No inrush current
- Lower noise at part load

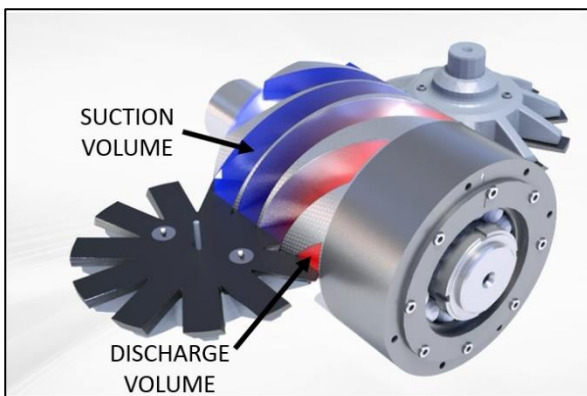
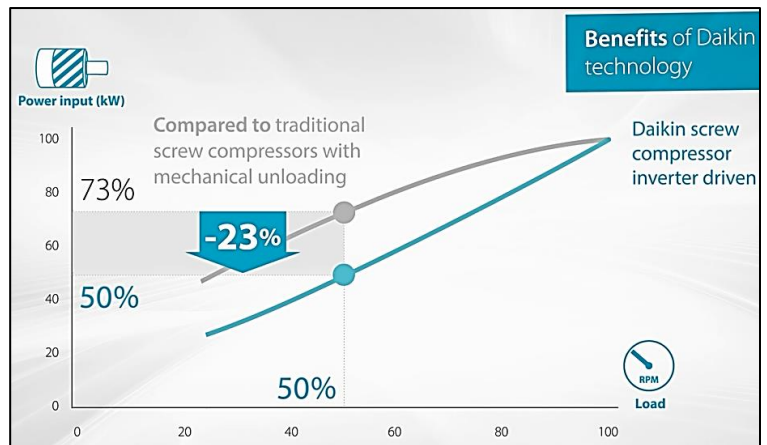

Variable Volume Ratio Technology

Screw compressors increase the refrigerant pressure by forcing it into a progressive smaller volume, from the suction to the discharge port. Once that the shape of the compressor is defined, the volume ratio of the compressor is also determined. The pressure ratio and the volume ratio are defined as follow and linked through the equation of the gas’ state.

$$\text{Volume ratio} = \frac{\text{refrigerant volume at compressor suction}}{\text{refrigerant volume at compressor discharge}}$$

$$\text{pressure ratio} = \frac{\text{refrigerant pressure at compressor discharge}}{\text{refrigerant pressure at compressor suction}}$$

$$\text{pressure ratio} = (\text{volume ratio})^k$$

Where k is a constant depending on the refrigerant used.

As a result the shape of the compressor defines the characteristic pressure ratio. On the market are available compressors optimized for different pressure ratios. A compressor optimized for low compression ratio will not be efficient in operations with high compression ratio and vice-versa.

The so called "internal" pressure ratio is one of the defining parameters of compressors used to choose the proper model according to the application.

For instance, in water-cooled chiller applications, where the operating pressure ratios are typically low, the best compressor is the one with lower internal pressure ratio. For an air-cooled chiller instead, the operating pressure ratios are typically higher and so the best solution could be a higher internal pressure ratio compressor.

Of course, the operating conditions of an air-cooled chiller are subject to change frequently because of the variation of ambient temperature and the fluctuations of the load.

An air-cooled chiller equipped with a compressor characterized by high volume ratio will have good performances at full load with high ambient temperatures; while in case of moderate ambient temperatures and during part load operation, the operating pressure ratio for the chiller will be lower than the compressor's internal pressure ratio. In such situation, the refrigerant will result more compressed than the actual needs.

This leads to a phenomenon named "over-compression". The "extra-work" of the compressor results in an unnecessary waste of energy.

On the other side, a chiller equipped with a compressor characterized by low volume ratio will have good performance during part load operation and low ambient temperature, but it will be less efficient during full load operation or with high ambient temperature.

In this case, the operating pressure ratio for the chiller will be higher than internal pressure ratio, so at the discharge of the compressor, the refrigerant will be at a lower pressure than the refrigerant already in the condenser. For this reason, part of the refrigerant will go from the condenser back to the compressor and the compressor will spend additional work to re-send it to the condenser. This phenomenon is known as "under-compression".

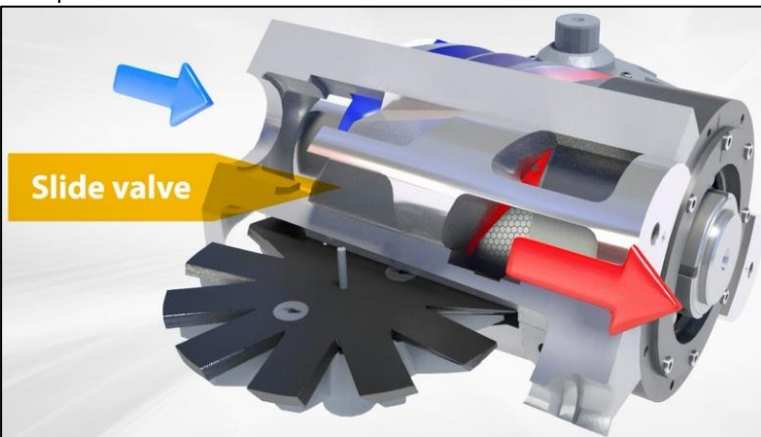

To obtain the best possible efficiency at every working condition, Daikin compressors can adjust the geometry of the discharge port according to the real operating conditions slightly delaying or anticipating the discharge phase of the refrigerant minimizing the losses for under or over compression and so enhancing the efficiency. This is possible thanks to a sliding valve.

So, while the Inverter modulates the compressors capacity in the most efficient way, the VVR controls the pressure ratio keeping the efficiency as the highest possible in every situation.

Refrigerant The compressors have been designed to operate with R-134a, ecological refrigerant with zero ODP (Ozone Depletion Potential) and low GWP (Global Warming Potential), resulting in low TEWI (Total Equivalent Warming Impact).

Cold heat exchanger The unit is equipped with a direct expansion shell & tube heat exchanger with refrigerant evaporating inside the tubes and water flowing outside. The tubes are enhanced for maximum heat transfer and rolled into steel tube sheet and sealed.

The cold heat exchanger is single-pass on water side and double-pass on the refrigerant side. Both the characteristics contribute to the heat exchanger effectiveness and total unit's outstanding efficiency. The water side is designed for 10 bar of maximum operating pressure and is provided with vents and drain.

The external shell is covered with a 20mm closed cell insulation material and the cold heat exchanger water connections are provided with Victaulic connections. The heat exchanger has 2 circuits, one for each compressor and it is manufactured in accordance to 2014/68/EU. A flow switch on cold heat exchanger is available as option (shipped loose). Water filter is not available as option from the factory.

Note: the installation of the filter is mandatory.

Hot heat exchanger The unit is equipped with a direct expansion shell & tube heat exchanger. The tubes are enhanced for maximum heat transfer and rolled into steel tube sheet and sealed.

The hot heat exchanger is single-pass on water side and double-pass on the refrigerant side. Both the characteristics contribute to the heat exchanger effectiveness and total unit's outstanding efficiency. The water side is designed for 10 bar of maximum operating pressure and is provided with vents and drain.

The external shell is covered with a 20mm closed cell insulation material and the hot heat exchanger water connections are provided with Victaulic connections. The heat exchanger has 2 circuits, one for each compressor and is manufactured in accordance to 2014/68/EU. A flow switch on hot heat exchanger is available as option (shipped loose). Water filter is not available as option from the factory.

Note: the installation of the filter is mandatory.

Source side air heat exchanger The air heat exchangers are manufactured with internally enhanced seamless copper tubes arranged in a staggered row pattern and mechanically expanded into lanced and rippled aluminum fins with full fin collars. The coil's fins are

Fans The fans are propeller type with high efficiency design blades to maximize performances. The material of the blades is glass reinforced resin and each fan is protected by a guard. Fans are installed in a belt-mouth with a diffuser to improve the air flow. The fan motors are AC with 6 poles and controlled by inverter.

The motors are protected by circuit breakers installed inside the electrical panel as a standard. The motors are IP54.

Electronic expansion valves The unit is equipped with the most advanced electronic expansion valves to achieve precise control of refrigerant mass flow. Each refrigerant circuit is equipped with 4 electronic expansion valves.

As today's systems require improved energy efficiency, tighter temperature control, wider range of operating conditions and incorporate features like remote monitoring and diagnostics, the application of electronic expansion valves becomes mandatory.

Electronic expansion valves possess unique features: short opening and closing time, high resolution, positive shut-off function to eliminate use of additional solenoid valve, continuous modulation of mass flow without stress in the refrigerant circuit and corrosion resistance stainless steel body.

Electronic expansion valves are typically working with lower ΔP between high and low-pressure side, than a thermostatic expansion valve. The electronic expansion valve allows the system to work with low condensing pressure (winter time) without any refrigerant flow problems and with a perfect chilled water leaving temperature control.

Refrigerant circuit

Each unit has two independent refrigerant circuits and each one includes:

- compressor Inverter driven with integrated oil separator;
- refrigerant;
- cold heat exchanger;
- hot heat exchanger;
- source side air heat exchanger;
- electronic expansion valves;
- discharge line shut off valve;
- sight glass with moisture indicator;
- filter drier;
- economizer circuit with electronic expansion valve;
- charging valves;
- high pressure switch;
- high pressure transducers;
- low pressure transducers;
- oil pressure transducer;
- suction temperature sensor.

Electrical control panel Power and control are in the main panel that is manufactured to ensure protection against all weather conditions. The electrical panel is IP54 and (when opening the doors) internally protected against possible accidental contact with live parts. The main panel is fitted with a main switch interlocked door that shuts off power supply when opening.

Power Section The power section includes compressors and fans protection devices, fans starters and control circuit power supply.

MicroTech 4 controller

The new MicroTech 4 controller is installed as standard in all Daikin chillers.

It gives the possibility to check the most relevant control parameters and modify unit set points. A built-in display shows unit operating status. Additionally, temperatures and pressures of water, refrigerant and air, programmable values, set-points can be accessed based on a preset list of user profiles.

A sophisticated software with adaptive logic, selects the most energy efficient combination of compressors, EEXV and fans to keep stable operating conditions to maximize unit energy efficiency and reliability. MicroTech 4 protects critical components based on external signals from onboard sub system (such as motor temperatures, refrigerant and oil pressures and temperatures, correctness of phase sequence, pressure switches and freezing of heat exchanger).

The input coming from high-pressure switches cuts all digital output from the controller in less than 50ms, as an additional security for the equipment. Fast program cycle (less than 200ms) for a precise monitoring of the system and sub systems. Floating point calculations supported for increased accuracy in Pressure / Temperature conversions.

Control main features

Control system has the following feature:

Management of compressors and fans modulation;

Control of cooling or heating leaving water temperatures;

Management of cooling and heating capacities according to the load;

Switch of operating modes in less than 1 minute;

Return reset (set point reset based on return water temperature);

- Set point reset (optional);
- Unit operation in partial failure condition;
- Managed operations during critical conditions:
 - High ambient temperature;
 - High thermal load;
 - Startup with high and low differential operating conditions;
 - Startup with high entering water temperature in cooling mode;
 - Startup with low entering water temperature in heating mode;
- Optimized management of compressor load;
- Optimized fan management according to condensing pressure;
- General faults alarm relay;
- Automatic re-start in case of power failure;

- Rapid Restart to recover full load in the shortest possible time for Data Centre application;
- ICM Standard control for multiple chillers management;
- Soft load (optimized management of the compressor load during the start-up);
- Start at high cold heat exchanger water temperature;
- Visualization of:
 - cooling and heating entering/leaving water temperature of heat exchangers;
 - outdoor ambient temperature;
 - condensing-evaporating temperature and pressure, suction and discharge superheat for each circuit;
 - hours and starts counter for compressors and pumps;
 - status safety devices;

Control additional features

- System upgrade with commercial SD cards;
- Save/Restore of configuration parameters with a commercial SD card;
- Ethernet port for remote or local servicing using standard web browsers;
- Daikin on Site connectivity for cloud based services

Safety device / logic for each refrigerant circuit

The following devices / logics are available:

- high pressure (pressure switch);
- high pressure (transducer);
- low pressure (transducer);
- fans circuit breakers;
- high compressor discharge temperature;
- high motor winding temperature;
- phase monitor;
- low pressure ratio;
- high oil pressure drops;
- low oil pressure;
- no pressure changes at start.

System security

The following securities are available:

- phase monitor;
- low ambient temperature lock-out;
- freeze protection.

Regulation type

Proportional integral derivative regulation on the cold heat exchanger leaving water output probe.

MicroTech 4

MicroTech 4 built-in terminal has the following features:

- Liquid crystal display with white back lighting, supports Unicode fonts for multi-lingual;
- Key-pad consisting of 3 keys;
- Push'n'roll control for an increased usability;
- Flash memory to protect the data;
- Password access to modify the setting;
- Application security to prevent application tampering or hardware usability with third party applications;
- Alarm history memory to allow an easy fault analysis.

Supervising systems (on request) MicroTech 4 remote communication

MicroTech 4 can communicate to BMS (Building Management System) based on the most common protocols as:

- ModbusRTU (Native);
- LonWorks,
- BACnet BTP certified over IP and MS/TP (class 4) (Native);
- Ethernet TCP/IP (Native).

Nomenclature

EWY D 500 4 Z X S B 2

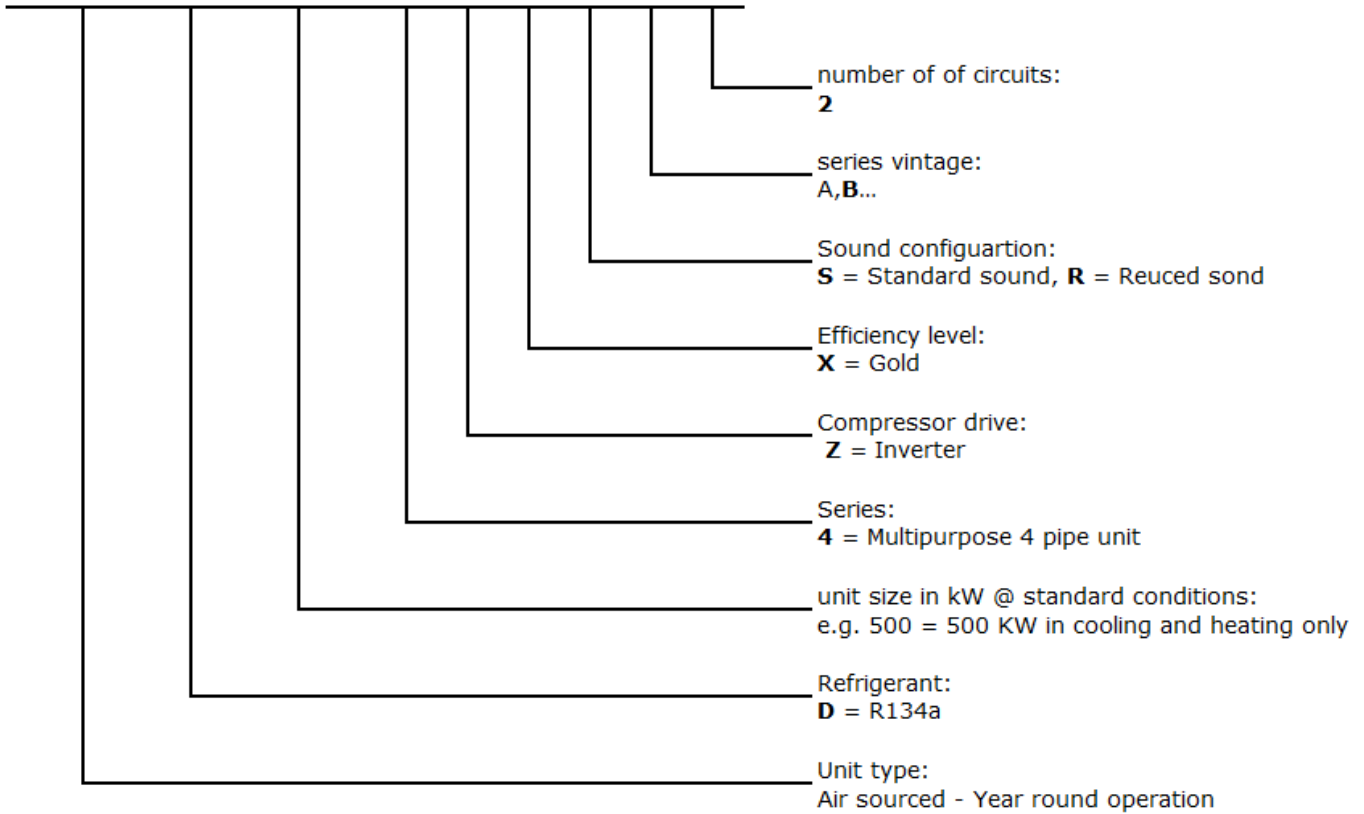

Options (provided as standard)

Evaporator Victaulic KIT (opt. code 20)

Condenser Victaulic KIT (opt. code 36)

20mm evaporator insulation (opt. code 29)

The heat exchanger is covered with a 20mm closed cell insulation material

20mm condenser insulation (opt. code 33)

The heat exchanger is covered with a 20mm closed cell insulation material

Discharge line shut-off valve (opt. code 61)

Installed on the discharge port of the compressor to facilitate maintenance operation.

Alucoat fins coil (opt. code 49)

Aluminum roll pre-coated with a thin layer of baked on acrylic anticorrosion coating prior to the fin stamping process. The treatment consists of a chemical degreasing (basic), a covering process with acrylic anticorrosive middle layer and a covering process with hydrophilic top layer.

The pre-coating material ensures the separation between copper tubes and aluminum fins, breaking the electrical connection and preventing galvanic corrosion, providing also a good protection in mildly corrosive coastal environments with NO impact on performance. When the air heat exchanger operates as evaporator, the hydrophilic layer helps to drain condensation from the coil's surface.

Note: Alucoat is not recommended in industrial settings or severe coastal environments.

Evaporator electric heater (opt. code 57)

Double set point (opt. code 10)

Dual leaving water temperature set-points.

Set point reset, demand limit and alarm from external device (opt. code 90)

Setpoint Reset: The leaving water temperature set-point can be overwritten with an external 4-20mA, through the ambient temperature or through the evaporator water temperature ΔT .

Demand Limit: Unit capacity can be limited through an external 4-20mA signal or via network.

Alarm from external device: The unit controller can receive an external alarm signal. The user can decide whether this alarm signal will stop the unit or not.

Ambient outside temperature sensor and setpoint reset (opt. code 67)

Compressor thermal overloads relays (opt. code 11)

Phase monitor (opt. code 13)

Device that monitors input voltage and stops the unit in case of phase loss or wrong phase sequence.

Electronic expansion valve (opt. code 60)

Hour run meter (opt. code 68)

General fault contactor (opt. code 69)

Main switch interlock door (opt. code 97)

Under over voltage control (opt. code 15)

Electronic device that monitors and displays input voltage and stops the unit in case of phase loss, wrong phase sequence or voltage exceeding minimum and maximum allowed values.

Fans circuit breakers (opt. code 96)

Safety devices that, added to the standard protection devices, protect fan motors against overload and overcurrent.

Fans speed regulation (INVERTER) (opt. code 99a)

The unit is equipped as standard with 6 poles AC fans controlled by inverter.

Master / Slave (opt. code 128)

4Z features DAIKIN Master/Slave (M/S) control. Once established which unit has the role of master, the other(s) will operate as slave(s) based on the inputs provided by the master.

The units must be installed in parallel in the hydronic plant on both cold and hot side.

Note: in case more units are installed in parallel check valves must be installed at the outlet of each unit.

It is possible to connect to four EWYD-4Z together. The units are connected by means of a two poles wire.

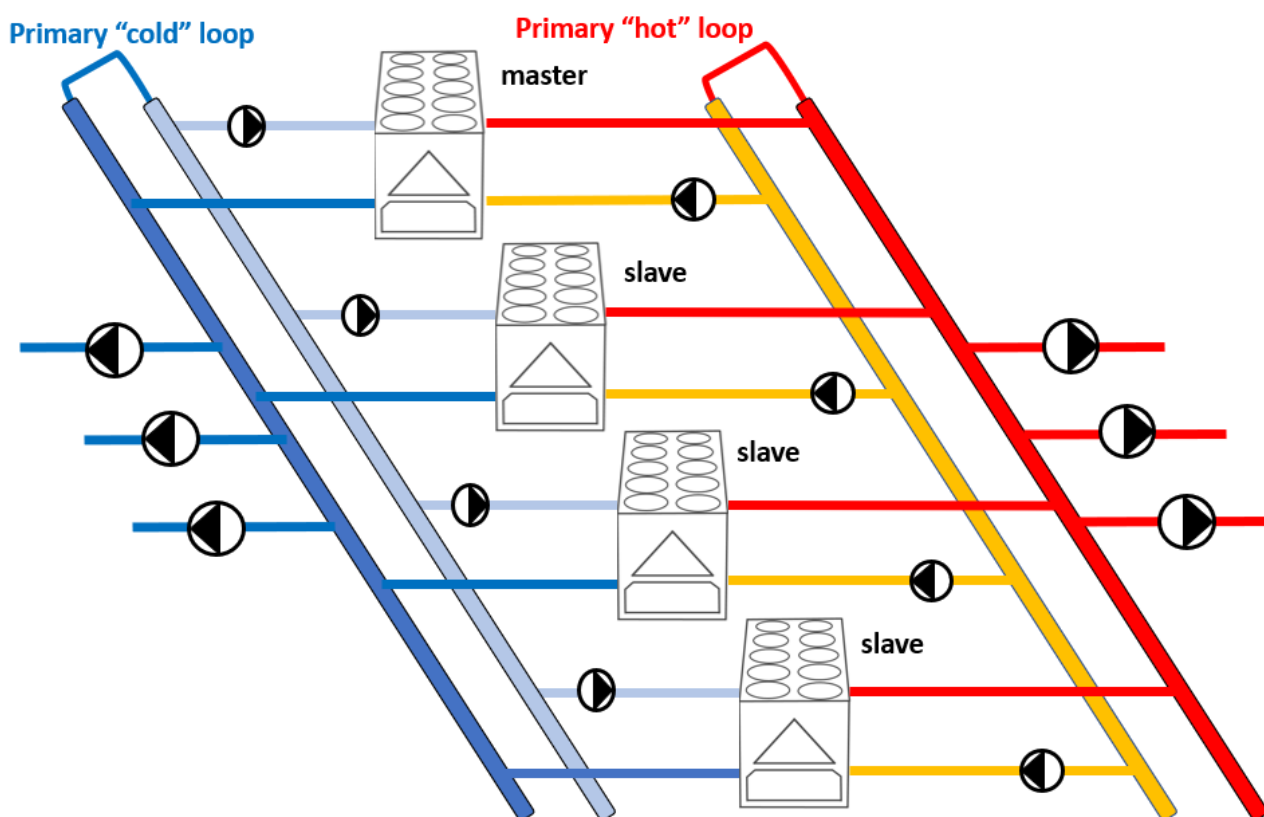

With Master / Slave is possible:

- to balance the working hours of the compressors enhancing reliability and extending the life of the system;
- improve the efficiency of the system
- to assign different priorities to the units connected.

With Master / Slave is not possible:

- to control mixed plant including 4Z and any other series among Daikin portfolio;
- to control multiple units' plant with variable flow logic (even if all 4Z are used);
- to control units with Rapid Restart functionality;

For all the above cases the Intelligent Chiller Manager (iCM) customized must be provided.

The option 143 Variable Primary Flow is not compatible with Master/Slave.

To operate with Master/Slave in Variable Primary flow Plants iCM must be provided. Contact the product specialist for information. To operate in Master/Slave (up to 4 EWYD-4Z connected) an additional probe (PT1000 or NTC10K) must be installed on the common line of the plant (cold and hot loop) and connected to the master unit for operating in Master / Slave mode. The additional probes are not provided by the factory.

Options (on request)

Brine Version (opt. code 08)

For operation with temperature at the outlet of the cold heat exchanger below +4°C the unit must operate with glycol mixture (with ethylene or propylene glycol) and the Brine Version option must be selected. The Brine version provides a dedicated control function and optimized heat exchanger (to be evaluated according to the operating condition).

Note: In case of order for unit including option 08, please submit the selection sheet together with all the information.

SOUND PROOF SYSTEM (COMPRESSOR) (opt. code 76b) Selecting this option the unit is provided with compressors enclosure for enhanced protection of the compressors, acoustic attenuation and improve aesthetics of the unit. In addition to the compressor enclosure, a flexible joint is inserted on compressor suction line significantly reduces the transmission of the vibration from the compressor to the chiller structure.

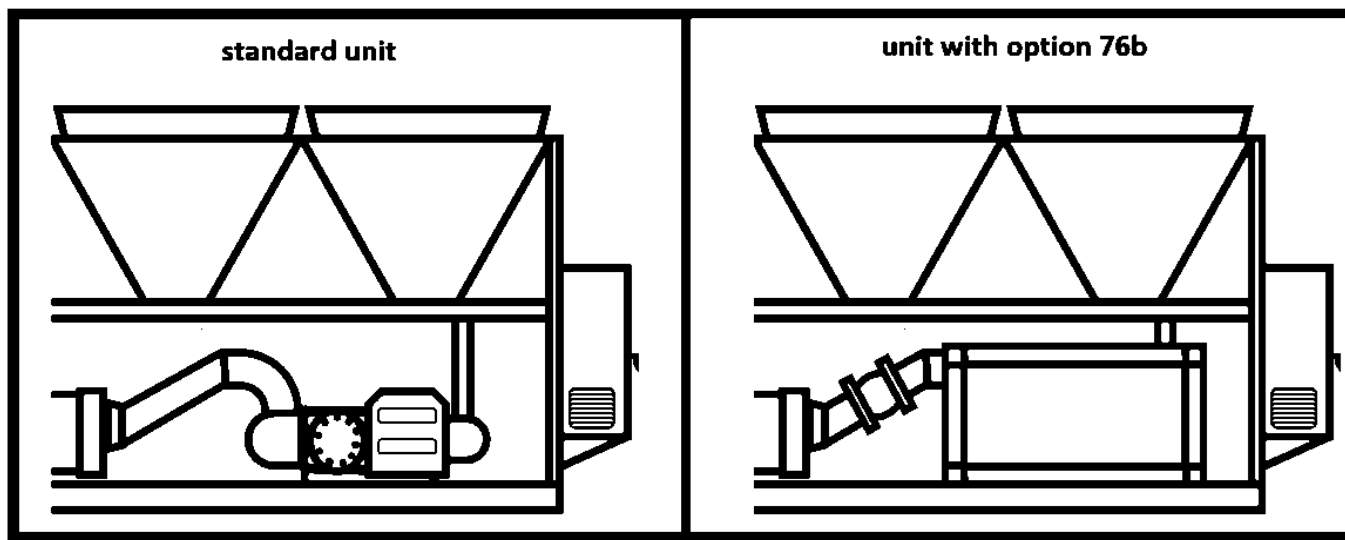

High Ambient kit (opt. code 142)

The 4Z is provided as standard with the inverter controlling the compressors speed integrated in the compressor's body and cooled by the refrigerant. As result, the inverter operation is not affected by the ambient temperature (even above +46°C). Other components (e.g. the inverter for the fans) could be affected by the ambient temperature. For this reason, in case the unit is going to operate frequently with ambient temperature equal or higher than +46°C, the option "High ambient kit" is advised.

The high ambient kit provides enhanced electrical components, EC fans instead of the AC fans controlled by inverter, enhanced electrical box ventilation (to be evaluated according to the unit set-up with options).

Nordic kit (opt. code 114)

Enhanced insulation on refrigerant piping and electric heater under the condensate tray

Evaporator flange kit (opt. code 21)

Condenser flange kit (opt. code 26)

Suction line shut-off valve (opt. code 62)

Installed on the suction port of the compressor to facilitate maintenance operation.

High pressure side manometers (opt. code 63)

Low pressure side manometers (opt. code 64)

Double pressure relief valve with diverter (opt. code 91)

Cu-Cu condenser coil (opt. code 45)

A copper wavy fin pattern is mechanically bonded to the standard copper tubes. The result is having condenser coils completely characterized by a unique material and this implies no potential differential and so no galvanic effects. The option is not suitable for polluted or industrial applications since many pollutants attack copper. The overall weight of the unit is higher compared to a traditional Cu-Al coil. Coastal corrosion durability in unpolluted marine environments can be substantially improved with absence of galvanic corrosion.

Blygold treatment (opt. code 117)

The air heat exchangers are treated with Blygold PoluAIXT consisting of a metallic impregnated polyurethane coating specifically designed for application to aluminum finned copper tube coils. It is a thin (25 microns), flexible, UV and impact resistant coating that exhibits excellent adherence to aluminum surfaces. PoluAIXT protects the parent metal against a wide range of corrosive salts, acids and other elements found in the atmosphere and provides protection superior to that of Cu/Cu coils. In addition to a superior ability to resist corrosion, the unique characteristics of PoluAIXT result in it having only a negligible effect on pressure drop and heat transfer of the coated coil. The unit coated with PoluAIXT receives all the benefits of corrosion protection without losing efficiency.

Refrigerant leak detection (opt. code 121)

Automated permanent refrigerant leak detection system installed on board. The refrigerant sensors are installed within the compressor acoustic enclosures and are specifically calibrated for R134a refrigerant. When leaks above a certain concentration are detected, the sensor sends a signal to the unit controller (a specific alarm is visualized on the unit microprocessor). The automatic shut down and pump down of refrigerant into the condensing section occurs on the detection of refrigerant leakage. The alarm threshold that triggers automatic pump down upon detection of refrigerant is set to a maximum of 2000ppm.

Note: Available only with unit equipped with option 76b SOUND PROOF SYSTEM (COMPRESSOR)

Compressors circuit breakers (opt. code 95)

Safety devices that include in a single option all safety functions otherwise provided by standard fuses and optional thermal relays, such as protection against overcurrent, overload, current unbalance.

Flow switch (opt. code 58a)

2 flow switches supplied separately to be wired and installed on the evaporator and condenser water piping (by the customer).

Note: The installation of the flow switches on both side (cold and hot) is mandatory.

Brushless fans up to 900 RPM (opt. code 158)

Selecting this option, the unit fans are equipped with Electronically Commuted (brushless) motor.

100 PA ESP fans (opt. code 160)

The performances of the unit are declared with no external static pressure. In case the installation requires additional static pressure on the discharge of the fans it is possible to install bigger EC motor fans capable to deliver up to 100 Pa of external static pressure.

200 PA ESP fans (opt. code 161)

The performances of the unit are declared with no external static pressure. In case the installation requires additional static pressure on the discharge of the fans it is possible to install bigger EC motor fans capable to deliver up to 200 Pa of external static pressure.

Hydronic kits:

- **One centrifugal pump (Low lift) (opt. code 78)**
- **One centrifugal pump (High lift) (opt. code 79)**
- **Two centrifugal pumps (Low lift) (opt. code 80)**
- **Two centrifugal pumps (High lift) (opt. code 81)**

Hydronic kits are installed on board of the unit on a dedicated part of the frame. The length of the unit provided with hydronic kit option is increased by approximately 1500 mm compared to the standard unit.

Please refer to the relative table in the "Options (Technical data)" chapter.

The Low lift hydronic kits provide an average available head of about 150 – 200 kPa or more at chiller standard conditions.

The High lift hydronic kits provide an average available head of about 250 - 300 kPa or more at unit standard conditions.

Please refer to the relative graphs in the " Options (Technical data)" chapter.

The kit is completed with pressure gauge, safety valve, drain valve. The motor pump is protected by a circuit breaker installed in control panel. The kit is assembled and wired to the control panel. The pipe and pump are protected from freezing with an additional electrical heater.

Note: In case of unit equipped with hydronic kit on board selected to operate with over 30% of glycol mixture, contact factory.

Inverter kit for pumps:

- **Inverter kit for 1 centrifugal pump Low lift (opt. code 120e)**
- **Inverter kit for 1 centrifugal pump High lift (opt. code 120f)**
- **Inverter kit for 2 centrifugal pumps Low lift (opt. code 120g)**
- **Inverter kit for 2 centrifugal pumps High lift (opt. code 120h)**

Note: The Inverter kit must be associated with the corresponding hydronic kit (opt. code 78/79/80/81).

The inverter kit can be used for the following purposes:

- **Possibility to manage, independently on both heat exchangers, the variable or fixed water flow**
It is possible, for example, to produce chilled water with variable flow and hot water with fixed flow.

All possible combinations:

- Chilled water with fixed flow & Hot water with fixed flow
- Chilled water with fixed flow & Hot water with variable flow
- Chilled water with variable flow & Hot water with fixed flow
- Chilled water whit variable flow & hot water whit variable flow

NOTE: For a single installation only

In case of multiple installation, iCM is required

- **Tuning the water flow during unit commissioning**

- **Control the pump speed via external input from Building Management System (BMS)**

For this application, a 0-10V signal for the pump speed must be provided from the plant manager according to the specific control strategy of the plant. The water must be within the minimum and maximum value allowed for the unit (refer to the "Operating limit" chapter). The change in water flow rate must not be exceed more than 10% of the design water flow rate per minute.

- **Set a "thermostat off" pump speed**

Providing the unit with the inverter kit for the on-board pump it is possible to manage two different water flow settings. A setting for water flow during the "Thermostat ON" mode (when the unit is now providing cooling to the plant) and a set for the "thermostat OFF" mode (when the plant load is satisfied and the compressors are waiting to start). This feature allows to achieve energy saving on plant operating cost by reducing the speed of the pumps when the unit has reached the set point.

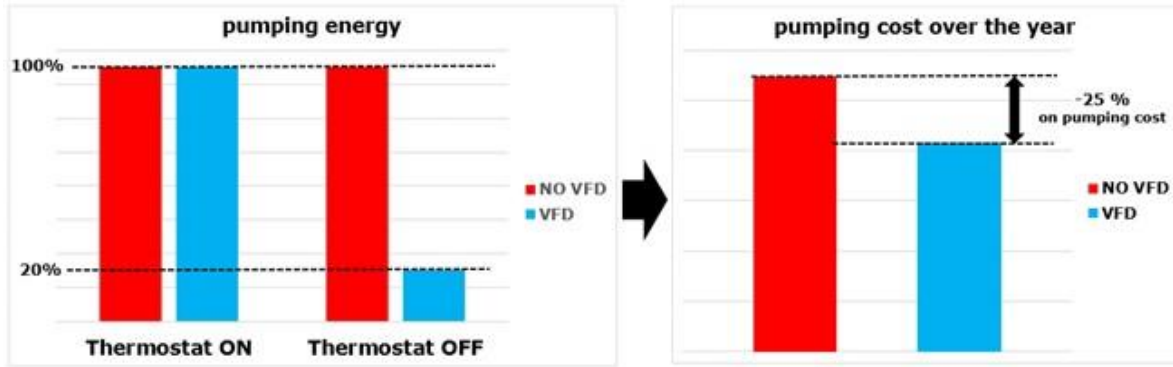

Thanks to the saving on pumping cost, the payback time for the Inverter Kit is approximately one year.

Variable Primary Flow (opt. code 143)

The Variable Primary Flow (VPF) configuration is an alternative to the more “traditional” Primary/Secondary (P/S) plant configuration.

An installation must follow all the design criteria for such systems to be defined as Variable Primary Flow.

For this reason, the option 143 should be ordered only if the customer asks for unit capable to manage the speed of the pump in a system designed to operate according to the Variable Primary Flow configuration and not as a general answer to “variable pump speed”.

By selecting opt. 143, the 4Z can manage the variable primary water flow according to the differential pressure measured in a specific point of the plant, selected by the plant designer.

Daikin Applied Europe is not responsible for the plant configuration and cannot confirm the optimal position of the differential pressure transducer.

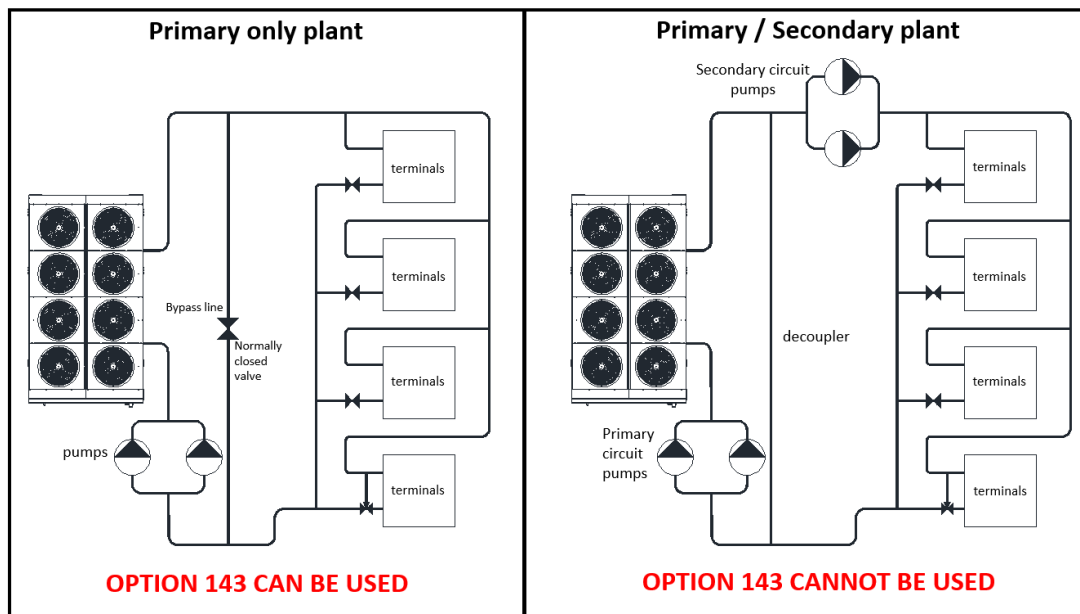

For unit installed in Primary/Secondary plants the option Variable Primary Flow is not applicable. In this case a different a different control is required.

For different kind of water flow management iCM must be provided.

In order to operate in Primary/Secondary plants with variable flow in primary loop the iCM must be provided.

The option 143 can be selected only together with the other hydronic kit option (see the table below).

	Fixed speed	Variable speed pump (for “thermostat off” pump speed function or to be controlled with external BMS)	Variable Primary Flow management
ONE CENTRIFUGAL PUMP (LOW LIFT)	Opt 78	Opt 78 + Opt 120e	Opt 78 + Opt 120e + Opt 143
ONE CENTRIFUGAL PUMP (HIGH LIFT)	Opt 79	Opt 79 + Opt 120f	Opt 79 + Opt 120f + Opt 143
TWO CENTRIFUGAL PUMP (LOW LIFT)	Opt 80	Opt 80 + Opt 120g	Opt 80 + Opt 120g + Opt 143
TWO CENTRIFUGAL PUMP (HIGH LIFT)	Opt 81	Opt 81 + Opt 120h	Opt. 81 + Opt 120h + Opt 143

Note: the option 143 Variable Primary Flow (VPF) is intended for a single unit installation. In case of multiple units’ system in VPF plant iCM must be provided.

A bypass line (field supply) needs to be installed to guarantee that the minimum water flow of the unit is always supplied (refer to the “Operating limit” chapter for indication on minimum water flow). The bypass valve will be an ON/OFF normally closed valve controlled by the unit controller. In case the minimum water flow allowed is not reached, the unit will command the valve to open the bypass line restoring the water flow above the minimum value.

The option 143 includes:

- dedicated control logic;
- differential pressure transducers on cold and hot side installed and wired on the unit.

The unit with option 143 cannot manage external variable speed pumps. For such control iCM must be provided.

Differential pressure transducer (opt. code 144)

The differential pressure transducer is available as option from the factory (opt. code 144). Once placed on the plant, the differential pressure transducer must be connected to the unit. As alternative, the unit controller can receive directly the differential pressure value from an external BMS communicating with the standard communication protocols (e.g. MODBUS).

Is customer responsibility to evaluate the proper position for the differential pressure transducer.

In case of multiple units' installations in a primary only plant operating with variable flow, the DAIKIN Intelligent Chiller Manager (iCM) must be installed. Contact the iCM product specialist for more information.

Evaporator area guards (opt. code 44)

Wire mesh that covers the access to the bottom part around the unit.

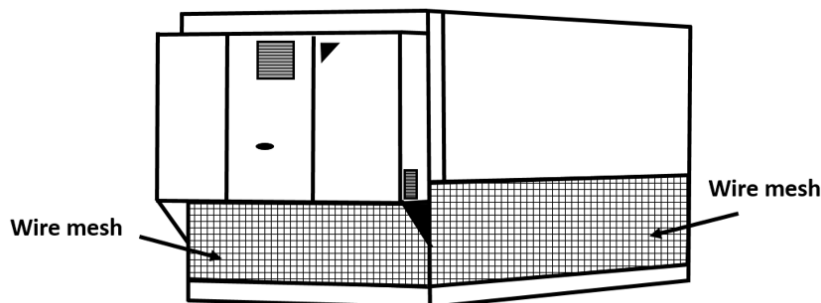

Condenser coil guards (opt. code 43)

Wire mesh that covers the air heat exchangers.

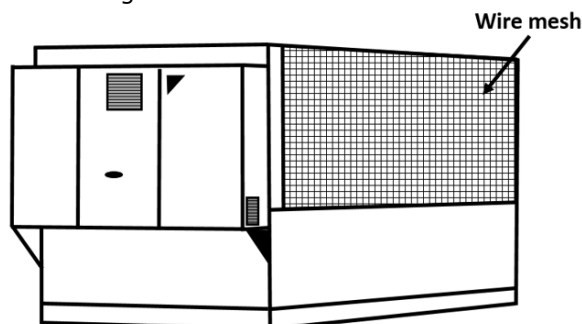

Energy meter (including current limit) (opt. code 16a)

Device installed inside the control box that displays all unit electrical power parameters at line input such as line voltage and phase current, input active and reactive power, active and reactive energy, including current limit option. An integrated RS485 module allows a Modbus communication to an external BMS.

Ground fault relay (opt. code 102)

To shut down the entire unit if a ground fault condition is detected.

Rapid restart (opt. code 110)

Rapid Restart is the ideal solution for those applications where we cannot afford the loose of cooling and heating such as data centers, health care facilities, process cooling ...etc. For this kind of applications, in case of a power failure, unit equipment is required to restore the cooling supply to the system as fast as possible. Standard unit (without the Rapid Restart option) will be starting within 310 seconds after the power is restored and it will be reaching full load cooling capacity within 20 ÷ 25 minutes (obviously depending on the load demand). With Rapid Restart, the unit is equipped with UPS module which keeps the unit controller always powered, avoiding the reboot time allowing the unit to start as right after power is restored and to reach full load capacity in less than 3 minutes from the unit restart.

Note: the time needed to restore the full capacity is depending from both cooling and heating load required. The maximum time required is 3 minutes in air-to water mode (when only cooling is required).

For more details about this option, please refer to the Control Manual.

Daikin on Site (DoS) modem with antenna (opt. code 155)

With Daikin On Site it is possible to have complete access to the unit controller through the cloud. The unit is equipped with a modem and a GSM card providing autonomous internet connection. In alternative, a LAN connection can be used if available.

The main functionalities of DoS are:

- predefined set of data points (~300 to >500 per controller/plant);
- predefined Read/Write access to data points;
- predefined set of Dashboards;
- Functionality for Users to create their own Dashboards;
- Alarm application and Alarm history;
- Alarm notification via email;
- Scheduling of Alarm notification;
- WEB-Access to local HMI;
- Dynamic WEB-Graphic;
- Possibility to upgrade firmware and software from remote (For some user roles);
- History log for cloud-based user interactions (e.g. change of a set point);
- Scheduler application;
- Documentation folder (E.g. release notes).

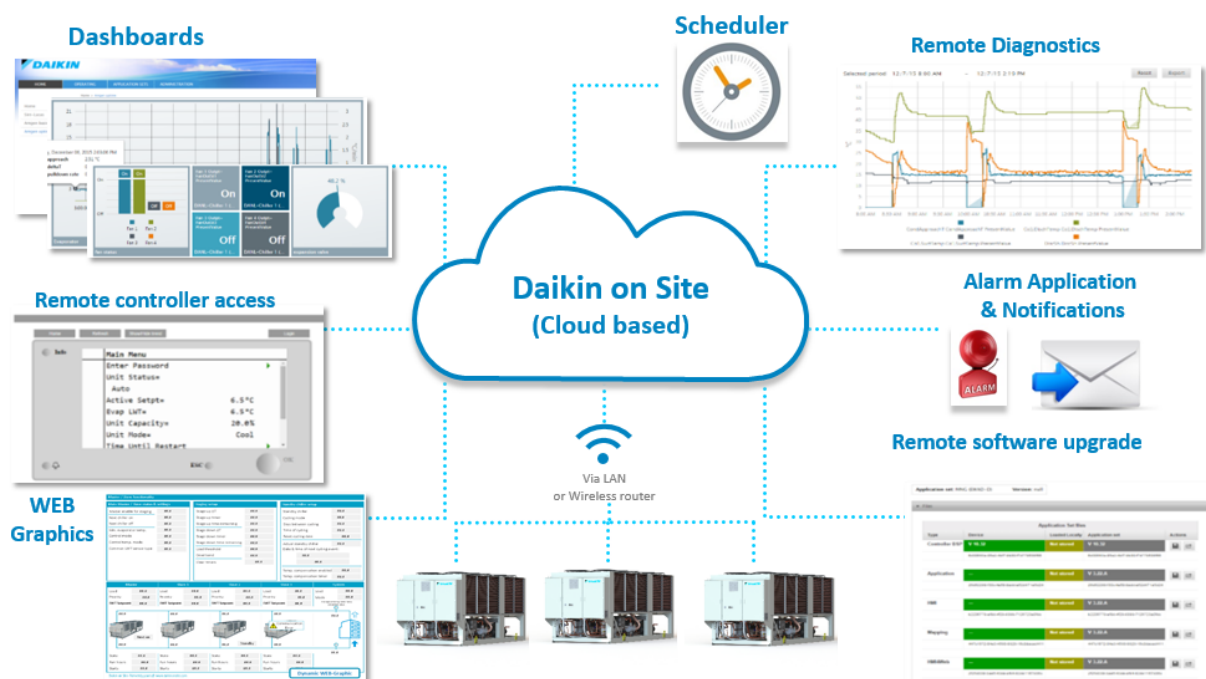

Rubber anti vibration mounts (opt. code 75)

Supplied separately, these are positioned under the base of the unit during installation. Ideal to reduce the vibrations when the unit is floor mounted.

Spring anti vibration mounts (opt. code 77)

Supplied separately, these are positioned under the base of the unit during installation. Ideal for dampening vibrations for installation on roofs and metallic structures.

Container Kit (opt. code 71)

Transport kit (opt. code 112)

EWYD~4ZXSB2 – standard unit

MODEL	notes		400	450	500	550	600	650	700	800
Cooling Capacity - C/O	(1)	kW	402,4	438,4	502,8	523,4	602,4	653,7	702,9	785,7
Power Input - C/O	(1)	kW	126,9	139,0	154,7	170,2	185,7	205,0	208,8	238,7
EER - C/O	(1)	kW/kW	3,17	3,15	3,25	3,08	3,25	3,19	3,37	3,29
Minimum Capacity - C/O	(1)	%	17	15	15	13	13	12	11	10
Heating Capacity - H/O										
Heating Capacity - H/O	(2)	kW	402,7	439,7	503,5	545,2	600,9	654,7	702,4	803,0
Power Input - H/O	(2)	kW	121,0	128,8	146,1	158,5	174,1	193,6	197,6	226,6
COP - H/O	(2)	kW/kW	3,33	3,41	3,45	3,44	3,45	3,38	3,55	3,54
Cooling Capacity - C+H										
Cooling Capacity - C+H	(3)	kW	313,2	351,6	393,9	430,4	479,4	516,0	553,3	634,4
Heating Capacity - C+H	(3)	kW	402,4	449,3	503,4	549,4	608,8	658,3	707,1	808,9
Power input - C+H	(3)	kW	89,1	97,8	109,4	119,0	129,5	142,4	153,7	174,4
TER - C+H	(3)	kW/kW	8,03	8,19	8,20	8,24	8,40	8,25	8,20	8,27
Evaporator										
Evaporator water flow rate	(1)	l/s	19,3	21,0	24,1	25,1	28,8	31,3	33,6	37,6
Evaporator pressure drop	(1) (4)	kPa	42,0	50,8	40,1	47,8	48,0	34,2	40,7	37,1
Evaporator water volume	(8)	lt	126	126	214	214	369	361	468	468
Evaporator minimum water flow rate	(9)	l/s	9,1	9,1	13,4	13,4	14,6	19,5	20,8	26,1
Condenser										
Condenser water flow rate	(2)	l/s	19,4	21,2	24,3	26,3	29,0	31,6	33,9	38,7
Condenser pressure drop	(2) (4)	kPa	38,3	45,3	34,5	38,3	36,1	26,5	30,8	29,5
Condenser water volume	(8)	lt	126	126	214	214	369	361	468	468
Condenser minimum water flow rate	(9)	l/s	9,1	9,1	13,4	13,4	14,6	19,5	20,8	26,1
Sound										
Sound Power	(1) (5)	dB(A)	99	98	99	99	100	100	102	102
Sound Pressure @ 1 meter	(1) (6)	dB(A)	78	77	77	78	78	79	80	80
Fans										
Number of fans		n	10	10	12	12	14	16	16	16
Air flow	(7)	l/s	56550	56550	67860	67860	79170	90480	90480	90480
Charges										
Oil charge		lt	28	28	28	28	28	28	38	38
Refrigerant Charge	(8)	kg	198	207	200	219	247	260	328	354
Dimensions										
Unit length	(8)	mm	5825	5825	6725	6725	7625	8525	8525	8525
Unit width	(8)	mm	2285	2285	2285	2285	2285	2285	2285	2285
Unit height	(8)	mm	2465	2465	2465	2465	2465	2465	2465	2465
Unit weight - shipping	(8)	kg	6075	6095	6870	6870	7850	8435	9405	9430
Unit weight - operation	(8)	kg	6540	6560	7560	7560	8935	9540	10785	10820
Water connection size	(8)	mm	219,1	219,1	219,1	219,1	219,1	219,1	219,1	219,1
Water connection type		-	Victaulic							
<p>(1) – (standard conditions Air to water - Cooling Only) evaporator water in/out = 12/7°C; ambient = 35.0°C, unit at full load operation in Cooling Only; operating fluid: Water; fouling factor = 0°C/W</p> <p>(2) – (standard conditions Air to water - Heating Only) condenser water in/out = 40/45°C; ambient = 7.0°C, unit at full load operation in Heating Only; operating fluid: Water; fouling factor = 0°C/W</p> <p>(3) – (standard conditions Water to water - Cooling + Heating) evaporator water out = 7°C; condenser water out = 45°C operating fluid: Water; fouling factor = 0°C/W</p> <p>(4) - not including filter pressure drop. The installation of the filter is mandatory.</p> <p>(5) - sound power level referred to standard conditions in Air to water - Cooling Only; full load operation is measured in accordance with ISO 9614</p> <p>(6) - Sound pressure level referred to standard conditions in Air to water - Cooling Only; full load operation is measured in accordance with ISO 3744</p> <p>(7) – referred to unit with free discharge on condenser fans.</p> <p>(8) – data subject to change in case of options or unit with customizations. Refer to unit's name plate for actual value.</p> <p>(9) – minimum flow rate applicable in variable flow application when the unit is running at minimum load.</p> <p>The above data are referred to the unit without additional optional.</p> <p>The above data are referred the unit installed in compliancy with installation prescription.</p> <p>All the data are subject to change without notice. For updated information on project base refer to Chiller Selection Software and unit's certified drawing.</p>										

EWYD~4ZXSb2 + OPT76b - Sound proof system (compressor)

MODEL	notes		400	450	500	550	600	650	700	800
Cooling Capacity - C/O	(1)	kW	402,4	438,4	502,8	523,4	602,4	653,7	702,9	785,7
Power Input - C/O	(1)	kW	126,9	139,0	154,7	170,2	185,7	205,0	208,8	238,7
EER - C/O	(1)	kW/kW	3,17	3,15	3,25	3,08	3,25	3,19	3,37	3,29
Minimum Capacity - C/O	(1)	%	17	15	15	13	13	12	11	10
Heating Capacity - H/O	(2)	kW	402,7	439,7	503,5	545,2	600,9	654,7	702,4	803,0
Power Input - H/O	(2)	kW	121,0	128,8	146,1	158,5	174,1	193,6	197,6	226,6
COP - H/O	(2)	kW/kW	3,33	3,41	3,45	3,44	3,45	3,38	3,55	3,54
Cooling Capacity - C+H	(3)	kW	313,2	351,6	393,9	430,4	479,4	516,0	553,3	634,4
Heating Capacity - C+H	(3)	kW	402,4	449,3	503,4	549,4	608,8	658,3	707,1	808,9
Power input - C+H	(3)	kW	89,1	97,8	109,4	119,0	129,5	142,4	153,7	174,4
TER - C+H	(3)	kW/kW	8,03	8,19	8,20	8,24	8,40	8,25	8,20	8,27
Evaporator water flow rate	(1)	l/s	19,3	21,0	24,1	25,1	28,8	31,3	33,6	37,6
Evaporator pressure drop	(1) (4)	kPa	42,0	50,8	40,1	47,8	48,0	34,2	40,7	37,1
Evaporator water volume	(8)	lt	126	126	214	214	369	361	468	468
Evaporator minimum water flow rate	(9)	l/s	9,1	9,1	13,4	13,4	14,6	19,5	20,8	26,1
Condenser water flow rate	(2)	l/s	19,4	21,2	24,3	26,3	29,0	31,6	33,9	38,7
Condenser pressure drop	(2) (4)	kPa	38,3	45,3	34,5	38,3	36,1	26,5	30,8	29,5
Condenser water volume	(8)	lt	126	126	214	214	369	361	468	468
Condenser minimum water flow rate	(9)	l/s	9,1	9,1	13,4	13,4	14,6	19,5	20,8	26,1
Sound Power	(1) (5)	dB(A)	96	95	96	96	97	96	98	98
Sound Pressure @ 1 meter	(1) (6)	dB(A)	75	74	74	75	75	75	76	76
Number of fans		n	10	10	12	12	14	16	16	16
Air flow	(7)	l/s	56550	56550	67860	67860	79170	90480	90480	90480
Oil charge		lt	28	28	28	28	28	28	38	38
Refrigerant Charge	(8)	kg	198	207	200	219	247	260	328	354
Unit length	(8)	mm	5825	5825	6725	6725	7625	8525	8525	8525
Unit width	(8)	mm	2285	2285	2285	2285	2285	2285	2285	2285
Unit height	(8)	mm	2465	2465	2465	2465	2465	2465	2465	2465
Unit weight - shipping	(8)	kg	6240	6260	7035	7035	8015	8600	9690	9715
Unit weight - operation	(8)	kg	6705	6725	7725	7725	9100	9705	11075	11110
Water connection size	(8)	mm	219,1	219,1	219,1	219,1	219,1	219,1	219,1	219,1
Water connection type		-	Victaulic							
<p>(1) - (standard conditions Air to water - Cooling Only) evaporator water in/out = 12/7°C; ambient = 35.0°C, unit at full load operation in Cooling Only; operating fluid: Water; fouling factor = 0°C/W</p> <p>(2) - (standard conditions Air to water - Heating Only) condenser water in/out = 40/45°C; ambient = 7.0°C, unit at full load operation in Heating Only; operating fluid: Water; fouling factor = 0°C/W</p> <p>(3) - (standard conditions Water to water - Cooling + Heating) evaporator water out = 7°C; condenser water out = 45°C operating fluid: Water; fouling factor = 0°C/W</p> <p>(4) - not including filter pressure drop. The installation of the filter is mandatory.</p> <p>(5) - sound power level referred to standard conditions in Air to water - Cooling Only; full load operation is measured in accordance with ISO 9614</p> <p>(6) - Sound pressure level referred to standard conditions in Air to water - Cooling Only; full load operation is measured in accordance with ISO 3744</p> <p>(7) - referred to unit with free discharge on condenser fans.</p> <p>(8) - data subject to change in case of options or unit with customizations. Refer to unit's name plate for actual value.</p> <p>(9) - minimum flow rate applicable in variable flow application when the unit is running at minimum load.</p> <p>The above data are referred to the unit without additional optional.</p> <p>The above data are referred the unit installed in compliancy with installation prescription.</p> <p>All the data are subject to change without notice. For updated information on project base refer to Chiller Selection Software and unit's certified drawing.</p>										

EWYD~4ZXRB2 – standard unit

MODEL	notes		400	450	500	550	600	650	700	800
Cooling Capacity - C/O	(1)	kW	357,9	400,4	451,9	496,2	548,0	596,5	619,1	690,0
Power Input - C/O	(1)	kW	117,4	131,0	145,0	162,4	176,4	194,6	194,0	224,1
EER - C/O	(1)	kW/kW	3,05	3,06	3,12	3,06	3,11	3,07	3,19	3,08
Minimum Capacity - C/O	(1)	%	20	18	17	14	14	13	12	11
Heating Capacity - H/O	(2)	kW	358,3	398,7	452,2	493,4	550,7	601	620,9	690,8
Power Input - H/O	(2)	kW	103,0	109,3	124,0	136,0	153,5	169,1	169,2	186,3
COP - H/O	(2)	kW/kW	3,48	3,65	3,65	3,63	3,59	3,55	3,67	3,71
Cooling Capacity - C+H	(3)	kW	281,5	312,7	351,1	383,1	435,2	473,1	489,3	543,8
Heating Capacity - C+H	(3)	kW	361,4	399,5	448,1	487,9	550,5	602,1	625,3	693,3
Power input - C+H	(3)	kW	79,9	86,9	97,0	104,8	115,3	129,1	136,0	149,6
TER - C+H	(3)	kW/kW	8,04	8,20	8,24	8,31	8,55	8,33	8,19	8,27
Evaporator water flow rate	(1)	l/s	17,1	19,2	21,6	23,7	26,2	28,5	29,6	33,0
Evaporator pressure drop	(1) (4)	kPa	31,8	37,1	31,7	38,7	39,0	27	33,7	28,1
Evaporator water volume	(8)	lt	126	126	214	214	369	361	468	468
Evaporator minimum water flow rate	(9)	l/s	9,1	9,1	13,4	13,4	14,6	19,5	20,8	26,1
Condenser water flow rate	(2)	l/s	17,3	19,2	21,8	23,8	26,6	29,0	30,0	33,3
Condenser pressure drop	(2) (4)	kPa	31,8	38,5	27,7	33,6	32,0	23,8	28,5	24,4
Condenser water volume	(8)	lt	126	126	214	214	369	361	468	468
Condenser minimum water flow rate	(9)	l/s	9,1	9,1	13,4	13,4	14,6	19,5	20,8	26,1
Sound Power	(1) (5)	dB(A)	87	86	87	87	88	88	90	90
Sound Pressure @ 1 meter	(1) (6)	dB(A)	66	66	66	66	66	66	68	69
Number of fans		n	10	10	12	12	14	16	16	16
Air flow	(7)	l/s	36110	36110	43332	43332	50554	57776	57776	57776
Oil charge		lt	28	28	28	28	28	28	38	38
Refrigerant Charge	(8)	kg	206	207	224	226	248	260	320	348
Unit length	(8)	mm	5825	5825	6725	6725	7625	8525	8525	8525
Unit width	(8)	mm	2285	2285	2285	2285	2285	2285	2285	2285
Unit height	(8)	mm	2465	2465	2465	2465	2465	2465	2465	2465
Unit weight - shipping	(8)	kg	6240	6260	7035	7035	8015	8600	9690	9715
Unit weight - operation	(8)	kg	6705	6725	7725	7725	9100	9705	11075	11110
Water connection size	(8)	mm	219,1	219,1	219,1	219,1	219,1	219,1	219,1	219,1
Water connection type		-	Victaulic							

- (1) – (standard conditions Air to water - Cooling Only) evaporator water in/out = 12/7°C; ambient = 35.0°C, unit at full load operation in Cooling Only; operating fluid: Water; fouling factor = 0°C/W
- (2) – (standard conditions Air to water - Heating Only) condenser water in/out = 40/45°C; ambient = 7.0°C, unit at full load operation in Heating Only; operating fluid: Water; fouling factor = 0°C/W
- (3) – (standard conditions Water to water - Cooling + Heating) evaporator water out = 7°C; condenser water out = 45°C operating fluid: Water; fouling factor = 0°C/W
- (4) – not including filter pressure drop. The installation of the filter is mandatory.
- (5) – sound power level referred to standard conditions in Air to water - Cooling Only; full load operation is measured in accordance with ISO 9614
- (6) – Sound pressure level referred to standard conditions in Air to water - Cooling Only; full load operation is measured in accordance with ISO 3744
- (7) – referred to unit with free discharge on condenser fans.
- (8) – data subject to change in case of options or unit with customizations. Refer to unit's name plate for actual value.
- (9) – minimum flow rate applicable in variable flow application when the unit is running at minimum load.

The above data are referred to the unit without additional optional.

The above data are referred to the unit installed in compliance with installation prescription.

All the data are subject to change without notice. For updated information on project base refer to Chiller Selection Software and unit's certified drawing.

EWYD~4ZXSB2 – standard unit										
MODEL	notes		400	450	500	550	600	650	700	800
SEER	(1)	kW/kW	4,56	4,60	4,87	4,72	4,92	5,03	5,17	5,14
SCOP	(2)		3,21	3,24	3,40	3,31	3,46	3,30	3,36	3,49

(1) SEER according to EN14825, fan coils application 12.0/7.0°C water temperature (for indication only).
 (2) SCOP as per EN14825, average climate, low temperature application (for indication only)

EWYD~4ZXSB2 + OPT76b - Sound proof system (compressor)										
MODEL	notes		400	450	500	550	600	650	700	800
SEER	(1)	kW/kW	4,56	4,60	4,87	4,72	4,92	5,03	5,17	5,14
SCOP	(2)		3,21	3,24	3,40	3,31	3,46	3,30	3,36	3,49

(1) SEER according to EN14825, fan coils application 12.0/7.0°C water temperature (for indication only).
 (2) SCOP as per EN14825, average climate, low temperature application (for indication only)

EWYD~4ZXRB2 – standard unit										
MODEL	notes		400	450	500	550	600	650	700	800
SEER	(1)	kW/kW	4,64	4,56	4,79	4,84	5,08	5,17	5,06	5,14
SCOP	(2)		3,20	3,22	3,32	3,29	3,30	3,27	3,33	3,38

(1) SEER according to EN14825, fan coils application 12.0/7.0°C water temperature (for indication only).
 (2) SCOP as per EN14825, average climate, low temperature application (for indication only)

EWYD~4ZXSB2 – standard unit										
MODEL	notes		400	450	500	550	600	650	700	800
Phases	(3)	n	3							
Frequency	(3)	Hz	50							
Voltage	(3)	V	400							
Tolerances Min/Max	(3)	%	-10/+10							
Compressor starting method		-	Variable Frequency Drive							
Starting current	(2)	A	0							
Nominal Running Current C/O	(1) (3)	A	239	279	288	337	350	384	384	456
Max. running current	(3) (4)	A	335	374	396	451	473	524	550	656
Max. current for wire sizing	(3) (5)	A	369	411	436	496	520	576	605	722
Fan starting method		-	Variable Frequency Drive							
Running current per fan	(1) (3)	A	3,2							
Total fans running current	(1) (3)	A	32,0	32,0	38,4	38,4	44,8	51,2	51,2	51,2
<p>(1) – (standard conditions Air to water - Cooling Only) evaporator water in/out = 12/7°C; ambient = 35.0°C, unit at full load operation in Cooling Only; operating fluid: Water; fouling factor = 0°C/W</p> <p>(2) – In case of Variable frequency drive starting method, the inrush current is equal to zero</p> <p>(3) – data subject to change in case of options or unit with customizations. Refer to unit's name plate for actual value.</p> <p>(4) – Maximum current absorbed by the unit (compressors and fans) @ 400 Volts</p> <p>(5) – Calculated as Max. running current x 1,1</p> <p>The above data are referred to the unit without additional optional.</p> <p>The above data are referred the unit installed in compliancy with installation prescription.</p> <p>All the data are subject to change without notice.</p> <p>For updated information on project base refer to Chiller Selection Software and unit's certified drawing and wiring diagram.</p>										

EWYD~4ZXR2 – standard unit										
MODEL	notes		400	450	500	550	600	650	700	800
Phases	(3)	n	3							
Frequency	(3)	Hz	50							
Voltage	(3)	V	400							
Tolerances Min/Max	(3)	%	-10/+10							
Compressor starting method		-	Variable Frequency Drive							
Starting current	(2)	A	0							
Nominal Running Current C/O	(1) (3)	A	199	228	245	297	305	321	344	385
Max. running current	(3) (4)	A	335	374	396	451	473	524	550	656
Max. current for wire sizing	(3) (5)	A	369	411	436	496	520	576	605	722
Fan starting method		-	Variable Frequency Drive							
Running current per fan	(1) (3)	A	0,5							
Total fans running current	(1) (3)	A	5	5	6	6	7	8	8	8
<p>(1) – (standard conditions Air to water - Cooling Only) evaporator water in/out = 12/7°C; ambient = 35.0°C, unit at full load operation in Cooling Only; operating fluid: Water; fouling factor = 0°C/W</p> <p>(2) – In case of Variable frequency drive starting method, the inrush current is equal to zero</p> <p>(3) – data subject to change in case of options or unit with customizations. Refer to unit's name plate for actual value.</p> <p>(4) – Maximum current absorbed by the unit (compressors and fans) @ 400 Volts</p> <p>(5) – Calculated as Max. running current x 1,1</p> <p>The above data are referred to the unit without additional optional.</p> <p>The above data are referred the unit installed in compliancy with installation prescription.</p> <p>All the data are subject to change without notice.</p> <p>For updated information on project base refer to Chiller Selection Software and unit's certified drawing and wiring diagram.</p>										

EWYD~4ZXS2 - standard unit									
MODEL		400	450	500	550	600	650	700	800
Main switch size	A	630	630	630	800	800	800	800	1000
Cable per phase	-	2x185 mm ²	2x185 mm ²	2x185 mm ²	2x240 mm ²	2x240 mm ²	2x240 mm ²	2x240 mm ²	2x300 mm ²
Short circuit current l _{cw} 1 sec.	kA	20	20	20	20	20	20	20	25

EWYD~4ZXS2 + OPT76b - standard unit									
MODEL		400	450	500	550	600	650	700	800
Main switch size	A	630	630	630	800	800	800	800	1000
Cable per phase	-	2x185 mm ²	2x185 mm ²	2x185 mm ²	2x240 mm ²	2x240 mm ²	2x240 mm ²	2x240 mm ²	2x300 mm ²
Short circuit current l _{cw} 1 sec.	kA	20	20	20	20	20	20	20	25

EWYD~4ZXR2 - standard unit									
MODEL		400	450	500	550	600	650	700	800
Main switch size	A	630	630	630	800	800	800	800	1000
Cable per phase	-	2x185 mm ²	2x185 mm ²	2x185 mm ²	2x240 mm ²	2x240 mm ²	2x240 mm ²	2x240 mm ²	2x300 mm ²
Short circuit current l _{cw} 1 sec.	kA	20	20	20	20	20	20	20	25

EWYD~4ZXS2 - OPT142									
MODEL		400	450	500	550	600	650	700	800
Main switch size	A	630	630	630	800	800	1000	1000	1000
Cable per phase	-	2x185 mm ²	2x185 mm ²	2x185 mm ²	2x240 mm ²	2x240 mm ²	2x300 mm ²	2x300 mm ²	2x300 mm ²
Short circuit current lcw 1 sec.	kA	20	20	20	20	20	25	25	25

EWYD~4ZXS2 + OPT76b - OPT142									
MODEL		400	450	500	550	600	650	700	800
Main switch size	A	630	630	630	800	800	1000	1000	1000
Cable per phase	-	2x185 mm ²	2x185 mm ²	2x185 mm ²	2x240 mm ²	2x240 mm ²	2x300 mm ²	2x300 mm ²	2x300 mm ²
Short circuit current lcw 1 sec.	kA	20	20	20	20	20	25	25	25

EWYD~4ZXR2 - OPT142									
MODEL		400	450	500	550	600	650	700	800
Main switch size	A	630	630	630	800	800	1000	1000	1000
Cable per phase	-	2x185 mm ²	2x185 mm ²	2x185 mm ²	2x240 mm ²	2x240 mm ²	2x300 mm ²	2x300 mm ²	2x300 mm ²
Short circuit current lcw 1 sec.	kA	20	20	20	20	20	25	25	25

EWYD~4ZXSB2 – standard unit										
Model	Sound pressure level @ 1 m from the unit (rif. 2 x10 ⁻⁵ Pa)								Sound pressure Lp @ 1 m	Sound power Lw
	63 Hz	125 Hz	250 Hz	500 Hz	1000 Hz	2000 Hz	4000 Hz	8000 Hz		
	dB								dB(A)	dB(A)
400	78	75	75	78	73	68	60	53	78	99
450	78	75	74	77	72	67	60	52	77	98
500	78	75	75	77	72	68	60	52	77	99
550	78	75	75	77	72	68	60	52	78	99
600	78	75	75	78	73	68	60	53	78	100
650	79	76	76	78	73	69	61	53	79	100
700	80	77	77	80	75	70	62	55	80	102
800	80	77	77	80	75	70	62	55	80	102

Data referred to standard conditions: Air to water - Cooling Onl; evaporator water in/out = 12/7°C; ambient = 35.0°C, unit at full load operation in Cooling Only; operating fluid: Water; fouling factor = 0°C/W

Sound Power levels are measured in accordance with ISO 9614

Sound Pressure levels are measured in accordance with ISO 3744

The sound data in the Octave band spectrum is based on calculation, thus intended for reference only and not considering binding.

All data are subject to change without notice. For updated information on project base refer to specific selections.

NOTE: with exception of OPT76b Sound proof system (COMPRESSOR) the other options from Price List have no impact on sound performances

Customized selection made to meet specific project's requirements could lead to change in sound performances. Refer to the customized selection for specific data.

EWYD~4ZXSB2 + OPT76b - Sound proof system (compressor)										
Model	Sound pressure level @ 1 m from the unit (rif. 2 x10 ⁻⁵ Pa)								Sound pressure Lp @ 1 m	Sound power Lw
	63 Hz	125 Hz	250 Hz	500 Hz	1000 Hz	2000 Hz	4000 Hz	8000 Hz		
	dB								dB(A)	dB(A)
400	75	72	72	75	70	65	57	50	75	96
450	75	72	71	74	69	64	57	49	74	95
500	75	72	72	74	69	65	57	49	74	96
550	75	72	72	74	69	65	57	49	75	96
600	75	72	72	75	70	65	57	50	75	97
650	75	72	72	74	69	65	57	49	75	96
700	76	73	73	76	71	66	58	51	76	98
800	76	73	73	76	71	66	58	51	76	98

Data referred to standard conditions: Air to water - Cooling Onl; evaporator water in/out = 12/7°C; ambient = 35.0°C, unit at full load operation in Cooling Only; operating fluid: Water; fouling factor = 0°C/W

Sound Power levels are measured in accordance with ISO 9614

Sound Pressure levels are measured in accordance with ISO 3744

The sound data in the Octave band spectrum is based on calculation, thus intended for reference only and not considering binding.

All data are subject to change without notice. For updated information on project base refer to specific selections.

NOTE: with exception of OPT76b Sound proof system (COMPRESSOR) the other options from Price List have no impact on sound performances

Customized selection made to meet specific project's requirements could lead to change in sound performances. Refer to the customized selection for specific data.

EWYD~4ZXRB2 – standard unit										
Model	Sound pressure level @ 1 m from the unit (rif. 2 x10⁻⁵ Pa)								Sound pressure Lp @ 1 m	Sound power Lw
	63 Hz	125 Hz	250 Hz	500 Hz	1000 Hz	2000 Hz	4000 Hz	8000 Hz		
	dB								dB(A)	dB(A)
400	67	64	63	66	61	56	49	41	66	87
450	66	63	63	66	60	56	48	41	66	86
500	66	63	63	66	60	56	48	41	66	87
550	66	63	63	66	61	56	48	41	66	87
600	67	64	63	66	61	56	49	41	66	88
650	67	64	64	66	61	57	49	41	66	88
700	68	65	65	68	63	58	50	43	68	90
800	69	66	66	68	63	59	51	43	69	90

Data referred to standard conditions: Air to water - Cooling On; evaporator water in/out = 12/7°C; ambient = 35.0°C, unit at full load operation in Cooling Only; operating fluid: Water; fouling factor = 0°C/W

Sound Power levels are measured in accordance with ISO 9614

Sound Pressure levels are measured in accordance with ISO 3744

The sound data in the Octave band spectrum is based on calculation, thus intended for reference only and not considering binding.

All data are subject to change without notice. For updated information on project base refer to specific selections.

NOTE: with exception of OPT76b Sound proof system (COMPRESSOR) the other options from Price List have no impact on sound performances

Customized selection made to meet specific project's requirements could lead to change in sound performances. Refer to the customized selection for specific data.

NOTES:

Despite "Sound power" and "Sound pressure" both share the same unit of measure, the decibel (dB), and the term "sound level" is commonly substituted for each they represent two distinct characteristics of sound.

Sound power is the acoustical energy emitted by the sound source. it is an absolute value and is not affected by the environment.

Sound pressure is a pressure disturbance in the atmosphere whose intensity is influenced not only by the strength of the source, but also by the surroundings and the distance from the source to the receiver.

Although dB is commonly used when referring to measuring sound, humans do not hear all frequencies equally. To account for this, corrections have been created to give a loudness measurement that takes into account how the human ear actually perceives sound. The most common of these corrections is the "A" weighting (different weights are applied at different frequencies). Values that have been corrected using the "A" weighting system are shown using units of dB(A). Values not corrected to account for human hearing are written using units of dB. The sound spectrum in octave band is reported in dB while the overall value of Sound power and pressure are in dB(A).

EWYD~4ZXSb2 – standard unit										
Model	Sound pressure at different distances [dB(A)]									
	@ 1 m	@ 2 m	@ 3 m	@ 4 m	@ 5 m	@ 6 m	@ 7 m	@ 8 m	@ 9 m	@ 10 m
400	78	76	74	72	71	70	69	68	67	67
450	77	75	73	71	70	69	68	67	66	66
500	77	76	74	72	71	70	69	68	67	66
550	78	76	74	72	71	70	69	68	67	66
600	78	76	75	73	72	71	70	69	68	67
650	79	76	74	73	72	71	70	69	68	67
700	80	78	76	75	74	73	72	71	70	69
800	80	78	76	75	74	73	72	71	70	69

EWYD~4ZXSb2 + OPT76b - Sound proof system (compressor)										
Model	Sound pressure at different distances [dB(A)]									
	@ 1 m	@ 2 m	@ 3 m	@ 4 m	@ 5 m	@ 6 m	@ 7 m	@ 8 m	@ 9 m	@ 10 m
400	75	73	71	69	68	67	66	65	64	64
450	74	72	70	68	67	66	65	64	63	63
500	74	73	71	69	68	67	66	65	64	63
550	75	73	71	69	68	67	66	65	64	63
600	75	73	72	70	69	68	67	66	65	64
650	75	72	70	69	68	67	66	65	64	63
700	76	74	72	71	70	69	68	67	66	65
800	76	74	72	71	70	69	68	67	66	65

EWYD~4ZXRB2 – standard unit										
Model	Sound pressure at different distances [dB(A)]									
	@ 1 m	@ 2 m	@ 3 m	@ 4 m	@ 5 m	@ 6 m	@ 7 m	@ 8 m	@ 9 m	@ 10 m
400	66	64	62	60	59	58	57	56	55	55
450	66	63	61	59	58	57	56	55	54	54
500	66	64	62	60	59	58	57	56	55	54
550	66	64	62	60	59	58	57	56	55	54
600	66	64	63	61	60	59	58	57	56	55
650	66	64	62	61	60	59	58	57	56	55
700	68	66	64	63	62	61	60	59	58	57
800	69	66	64	63	62	61	60	59	58	57

Note:
To calculate the sound pressure at different distances from the chiller the generic calculation of sound power from sound pressure is as follows:

$$L_p = L_w - 10 * \log_{10} A_d$$

Where Ad is the surface around the chiller calculated at the specific distance d; Lw is the sound power.

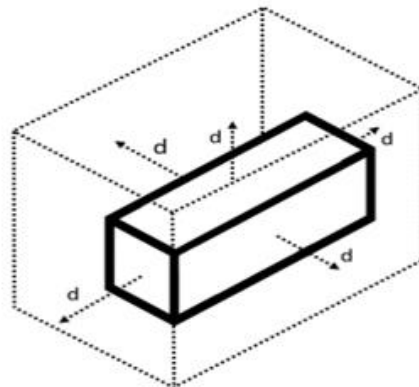

Operating limits Air to Water operation

Cooling only operation

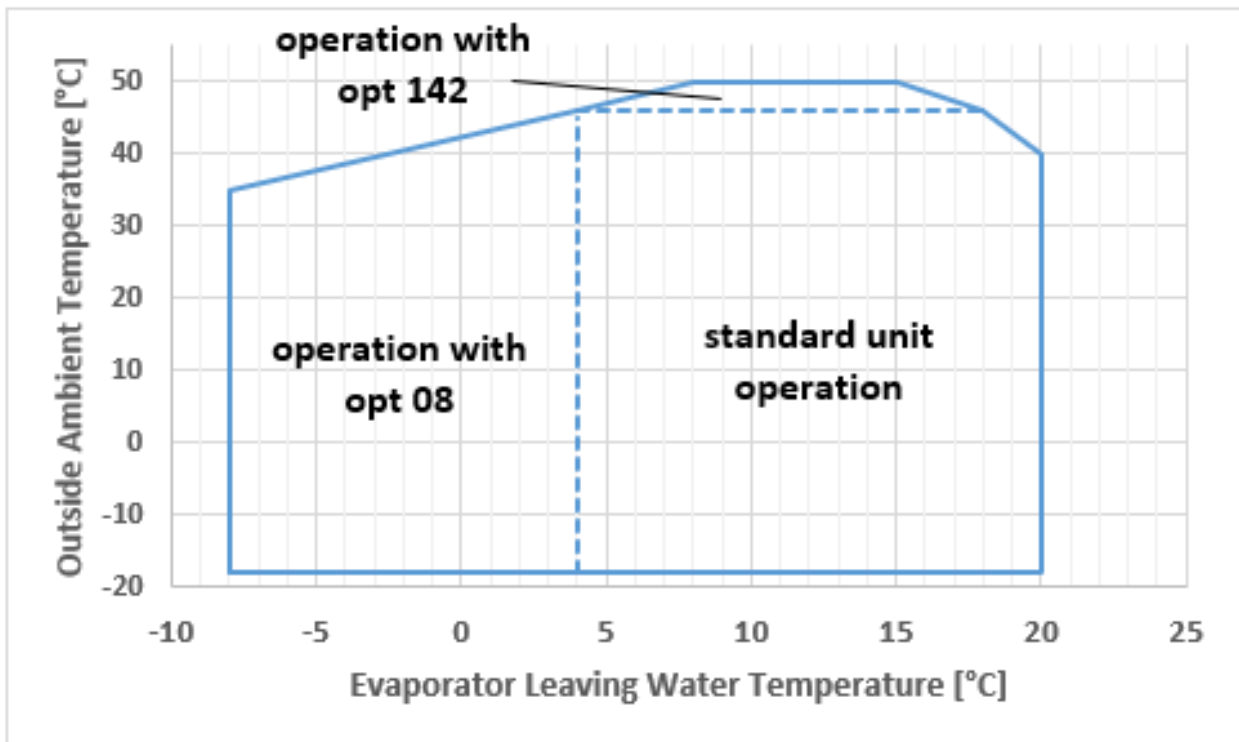

Heating only operation

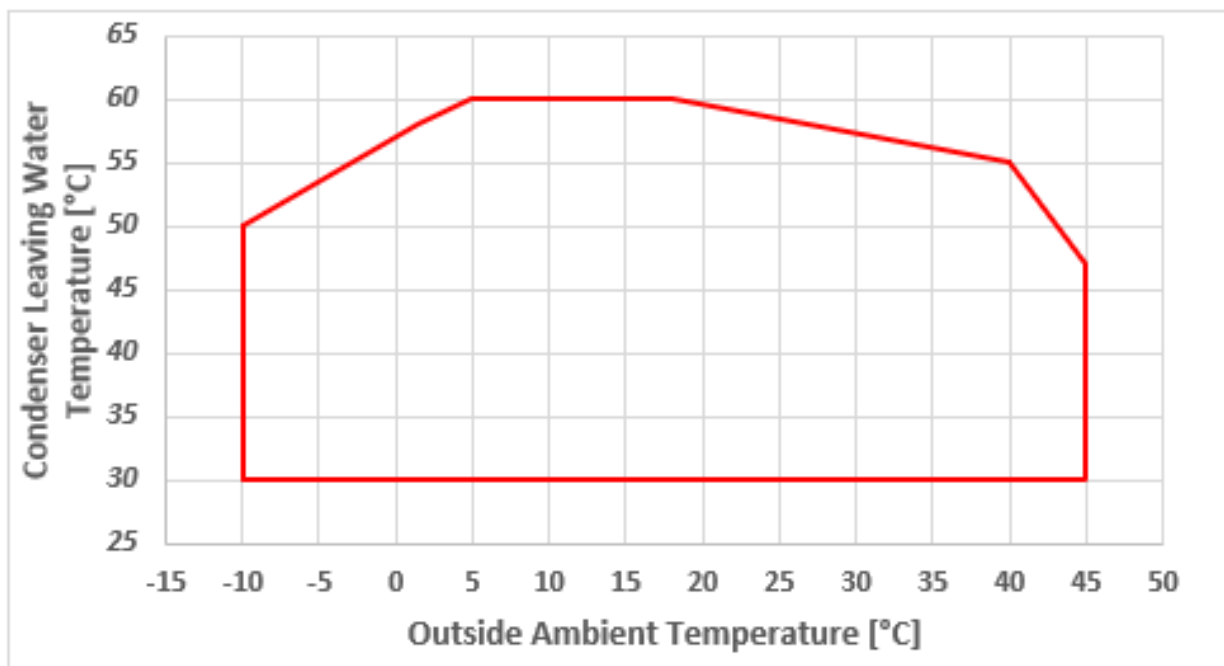

Note:

- The above graph refers to the unit operating at full load. Unit may be able to operate outside the above envelope with compressors unloading. Please contact factory for further details.
- For operation with temperature at the outlet of the cold heat exchanger below +4°C, the unit must operate with glycol mixture (ethylene or propylene glycol). The glycol percentage must be provided according to the minimum ELWT needed.
- The above graphic represents a guideline about the operating limits of the range. Please refer to the latest Chiller Selection Software (CSS) for real operating limits working conditions for each size.
- Opt. 142 provides EC motors fans. The performances will differ from the standards.

Operating limits Water to Water operation

Cooling + Heating operation

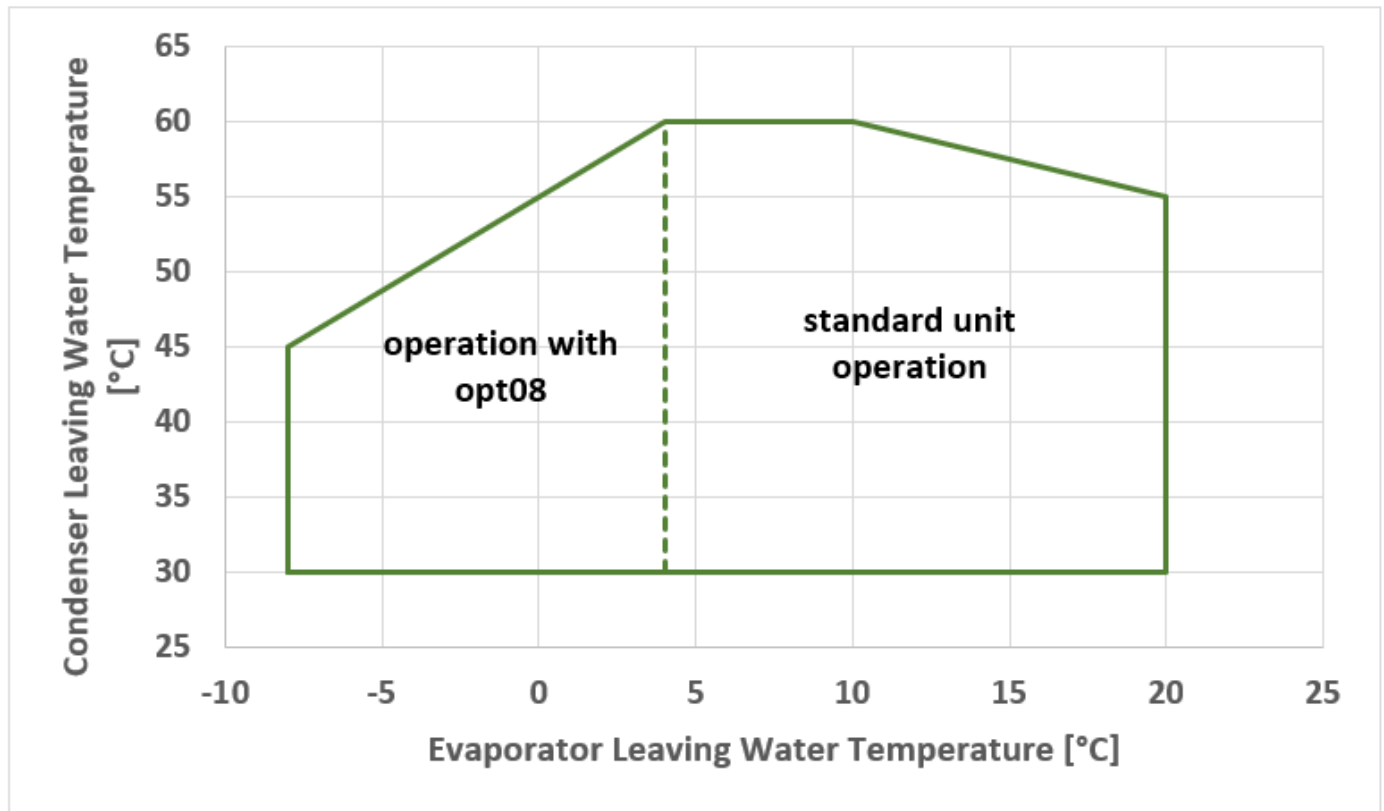

Note:

- The above graph refers to the unit operating at full load. Unit may be able to operate outside the above envelope with compressors unloading. Please contact factory for further details.
- For operation with temperature at the outlet of the cold heat exchanger below +4°C, the unit must operate with glycol mixture (ethylene or propylene glycol). The glycol percentage must be provided according to the minimum ELWT needed.
- The above graphic represents a guideline about the operating limits of the range. Please refer to the latest Chiller Selection Software (CSS) for real operating limits working conditions for each size.

Water heat exchanger - maximum/maximum water Δt

The minimum and maximum allowed Δt at full load conditions are respectively 4 °C and 8°C. Contact factory in case lower or higher Δt are required.

Minimum glycol percentage for low air ambient temperature to prevent freezing of the hydraulic circuit

Ambient temperature [°C]	-3	-8	-15	-20
Ethylene glycol [%]	10	20	30	40
Propylene Glycol [%]	10	20	30	40

In presence of glycol in the water system the performance will be affected. Refer to the selection software. All machine protection systems, such as antifreeze, and low-pressure protection will need to be adjusted in accordance to the type and percentage of the glycol.

Air heat exchanger - Altitude correction factors

Elevation above sea level	[m]	0	300	600	900	1200	1500	1800
barometric pressure	[mbar]	1013	977	942	908	875	843	812
Cooling capacity correction factors		1	0,993	0,986	0,979	0,973	0,967	0,96
Power input correction factors		1	1,005	1,009	1,015	1,021	1,026	1,031

Maximum operating altitude is 1800 m above sea level.

Contact factory if the unit has to be installed 1000 m above the sea level.

Operating limits for Storage Environmental conditions must be within the following limits:

- Minimum ambient temperature: -20°C
- Maximum ambient temperature: 57°C
- Maximum R.H.: 95% not condensing

Storage below the minimum temperature may cause damage to components. Storage above the maximum temperature causes opening of safety valves.

Storage in condensing atmosphere may damage electronic components.

Operating limits for Storage

Environmental conditions must be within the following limits:

- Minimum ambient temperature: -20°C
- Maximum ambient temperature: 57°C
- Maximum R.H.: 95% not condensing

Storage below the minimum temperature may cause damage to components. Storage above the maximum temperature causes opening of safety valves.

Storage in condensing atmosphere may damage electronic components.

Water treatment Before putting the unit into operation, clean the water circuit. Dirt, scales, corrosion debits and other material can accumulate inside the heat exchanger and reduce its heat exchanging capacity. Pressure drop can increase as well, thus reducing water flow. Proper water treatment therefore reduces the risk of corrosion, erosion, scaling, etc. The most appropriate water treatment must be determined locally, according to the type of system and water characteristics. The manufacturer is not responsible for damage to or malfunctioning of equipment caused by failure to treat water or by improperly treated water.

ACCEPTABLE WATER QUALITY LIMITS

Water quality requirements	Shell&tube
Ph (25 °C)	6.8 ÷ 8.4
Electrical conductivity [μ S/cm] (25°C)	< 800
Chloride ion [mg Cl ⁻ / l]	< 150
Sulphate ion [mg SO ₄ ²⁻ / l]	< 100
Alkalinity [mg CaCO ₃ / l]	< 100
Total Hardness [mg CaCO ₃ / l]	< 200
Iron [mg Fe / l]	< 1
Ammonium ion [mg NH ₄ ⁺ / l]	< 1
Silica [mg SiO ₂ / l]	< 50
Chlorine molecular (mg Cl ₂ /l)	< 5

Water-glycol mixture with the passing of time decays and it gives rise to acid products that can start corrosion processes. Also, the degradation of products in the water-glycol mixture may allow biological proliferation and thus bacteria formation can give rise to corrosion. For these reasons' glycol has to be used with suitable corrosion inhibitors.

The corrosion inhibitors have a lifespan (1 or 2 years) so it is important to periodically verify the percentage of the water-glycol mixture

Inhibitors may become insufficient due to "top ups" of water in the circuit (if water is added to the mixture due to low level, the percentage of glycol must remain as per requirements therefore the correct % of glycol should also be integrated.

The parameters to be checked regularly are the antifreeze concentration and the pH of water-glycol mixture

Single pump Low lift for models EWYD 400 ÷ 800 XSB2

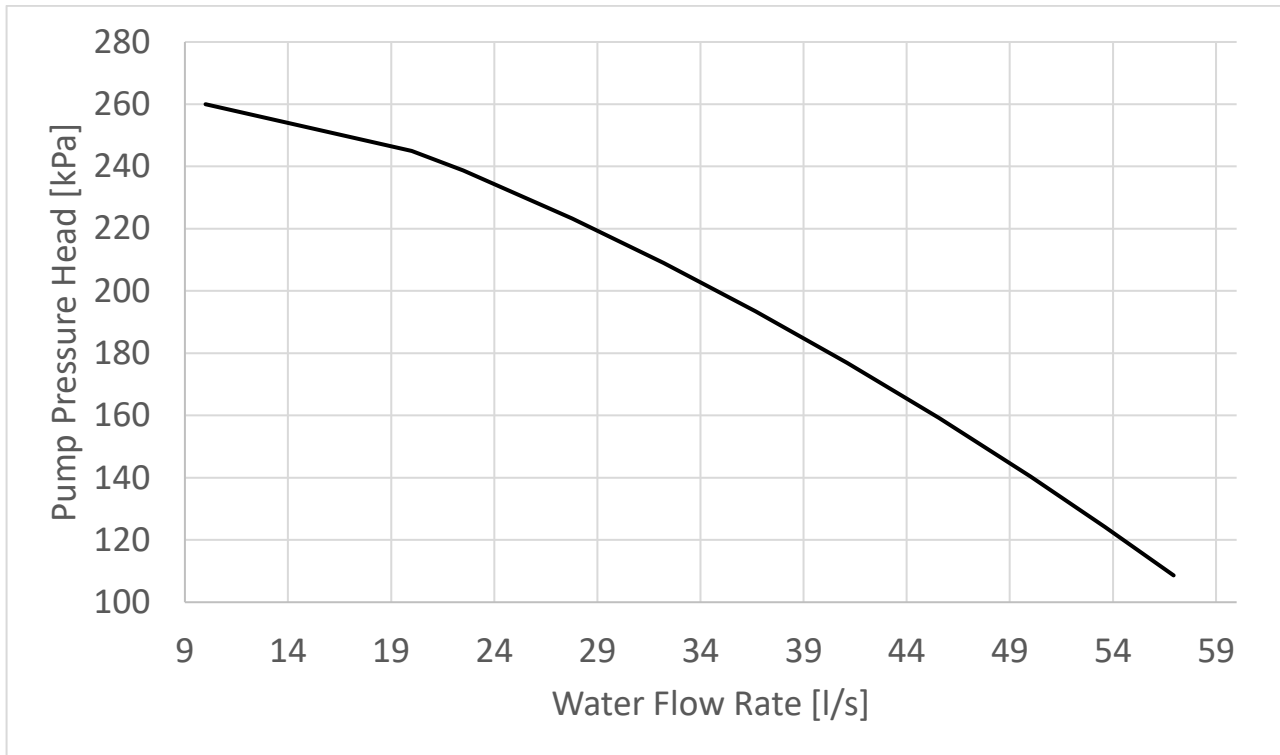

Technical data

EWYD~4ZXSB2 – standard unit								
	Pump motor power input	Pump moto current	Power supply	PN	Motor protection	Insulation class	Available water head @ std condition Cooling (1)	Available water head @ std condition Heating (2)
models	kW	A	V – ph. – Hz	-	-	-	kPa (3)	KPa (3)
400	22	40,4	400 - 3 - 50	10	IP55	F	204	215
450	22	40,4	400 - 3 - 50	10	IP55	F	190	202
500	22	40,4	400 - 3 - 50	10	IP55	F	194	207
550	22	40,4	400 - 3 - 50	10	IP55	F	180	194
600	22	40,4	400 - 3 - 50	10	IP55	F	172	188
650	22	40,4	400 - 3 - 50	10	IP55	F	178	188
700	22	40,4	400 - 3 - 50	10	IP55	F	164	176
800	22	40,4	400 - 3 - 50	10	IP55	F	150	163

- (1) - (standard conditions Air to water - Cooling Only) evaporator water in/out = 12/7°C; ambient = 35.0°C, unit at full load operation in Cooling Only; operating fluid: Water; fouling factor = 0°C/W
- (2) - (standard conditions Air to water - Heating Only) condenser water in/out = 40/45°C; ambient = 7.0°C, unit at full load operation in Heating Only; operating fluid: Water; fouling factor = 0°C/W
- (3) - not including filter pressure drop. The installation of the filter is mandatory.

Note: For calculating the total electrical data of the base unit selected with hydronic kit, the electrical data of the pump must be added to the electrical data of the base unit.

The electrical data refers to both pumps (cooling and heating side)

The above data are referred to the unit without additional optional.

The above data are referred the unit installed in compliancy with installation prescription.

All the data are subject to change without notice. For updated information on project base refer to Chiller Selection Software and unit's certified drawing and wiring diagram

The single pump kit is intended on both water side of the unit including 1 pump for cooling side, 1 pump for heating side.

Single pump High lift for models EWYD 400 ÷ 500 XSB2

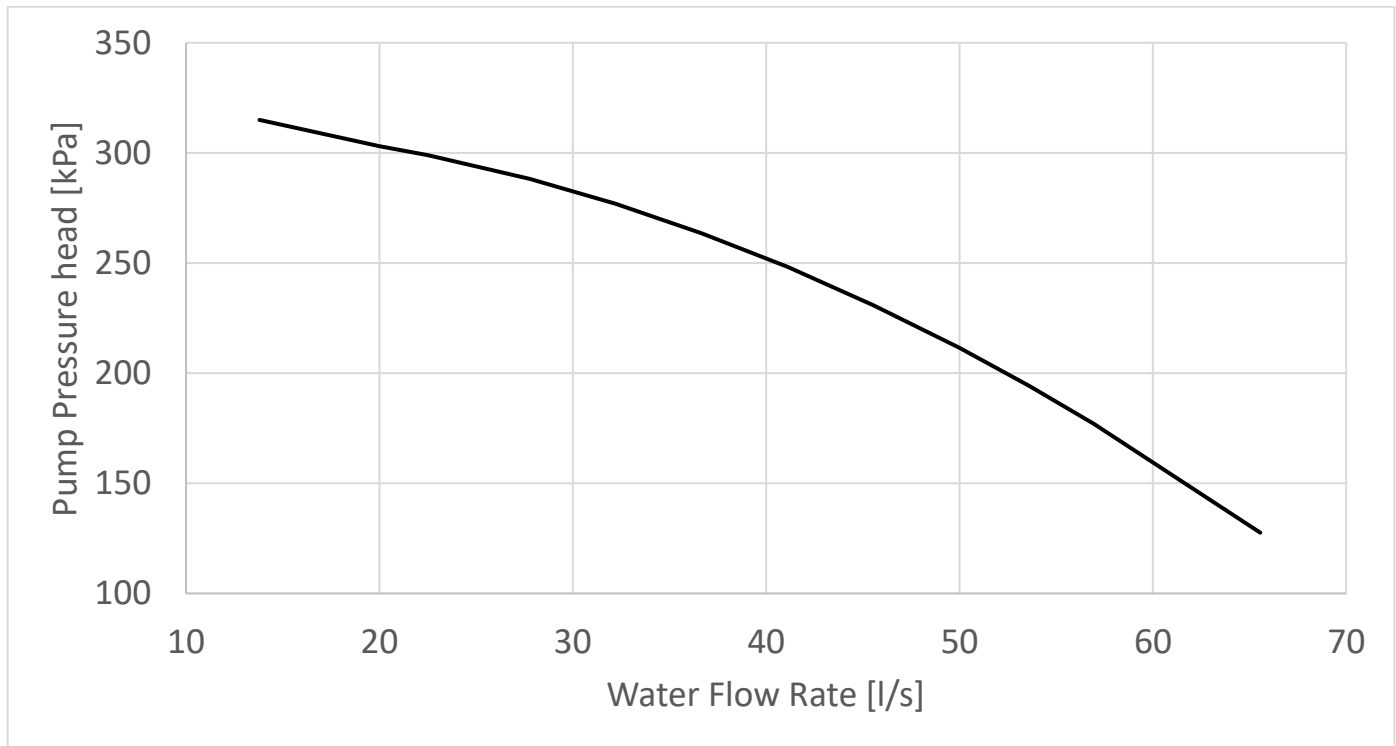

Technical data

EWYD~4ZXSB2 – standard unit								
	Pump motor power input	Pump motor current	Power supply	PN	Motor protection	Insulation class	Available water head @ std condition Cooling (1)	Available water head @ std condition Heating (2)
models	kW	A	V – ph. – Hz	-	-	-	kPa (3)	KPa (3)
400	30	53,2	400 - 3 - 50	10	IP55	F	262	272
450	30	53,2	400 - 3 - 50	10	IP55	F	250	262
500	30	53,2	400 - 3 - 50	10	IP55	F	256	268

- (1) - (standard conditions Air to water - Cooling Only) evaporator water in/out = 12/7°C; ambient = 35.0°C, unit at full load operation in Cooling Only; operating fluid: Water; fouling factor = 0°C/W
- (2) - (standard conditions Air to water - Heating Only) condenser water in/out = 40/45°C; ambient = 7.0°C, unit at full load operation in Heating Only; operating fluid: Water; fouling factor = 0°C/W
- (3) - not including filter pressure drop. The installation of the filter is mandatory.

Note: For calculating the total electrical data of the base unit selected with hydronic kit, the electrical data of the pump must be added to the electrical data of the base unit.

The electrical data refers to both pumps (cooling and heating side)

The above data are referred to the unit without additional optional.

The above data are referred the unit installed in compliancy with installation prescription.

All the data are subject to change without notice. For updated information on project base refer to Chiller Selection Software and unit's certified drawing and wiring diagram

The single pump kit is intended on both water side of the unit including 1 pump for cooling side, 1 pump for heating side.

Single pump High lift for models EWYD 550 ÷ 800 XSB2

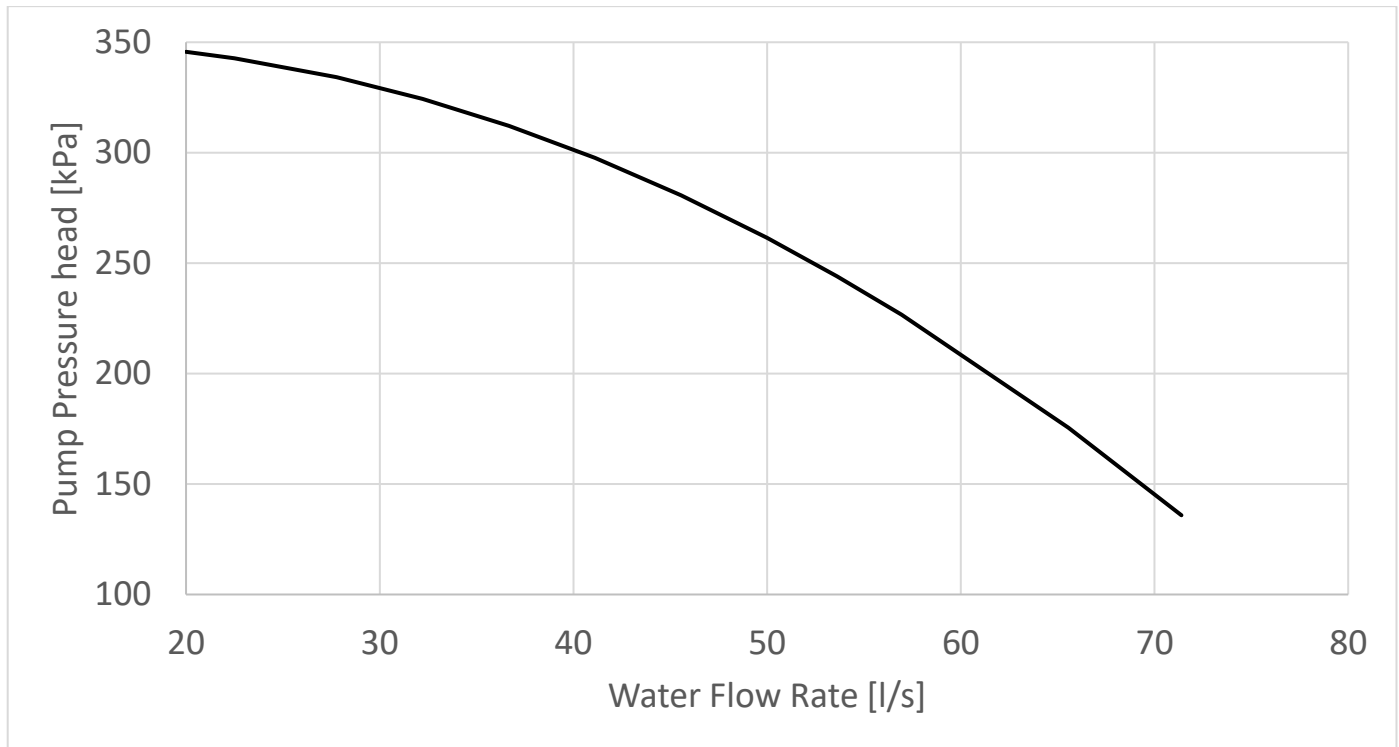

Technical data

EWYD~4ZXSB2 – standard unit								
	Pump motor power input	Pump moto current	Power supply	PN	Motor protection	Insulation class	Available water head @ std condition Cooling (1)	Available water head @ std condition Heating (2)
models	kW	A	V – ph. – Hz	-	-	-	kPa (3)	KPa (3)
550	37	66	400 - 3 - 50	10	IP55	F	243	291
600	37	66	400 - 3 - 50	10	IP55	F	284	332
650	37	66	400 - 3 - 50	10	IP55	F	292	327
700	37	66	400 - 3 - 50	10	IP55	F	280	321
800	37	66	400 - 3 - 50	10	IP55	F	270	307

- (1) – (standard conditions Air to water - Cooling Only) evaporator water in/out = 12/7°C; ambient = 35.0°C, unit at full load operation in Cooling Only; operating fluid: Water; fouling factor = 0°C/W
- (2) – (standard conditions Air to water - Heating Only) condenser water in/out = 40/45°C; ambient = 7.0°C, unit at full load operation in Heating Only; operating fluid: Water; fouling factor = 0°C/W
- (3) - not including filter pressure drop. The installation of the filter is mandatory.

Note: For calculating the total electrical data of the base unit selected with hydronic kit, the electrical data of the pump must be added to the electrical data of the base unit.

The electrical data refers to both pumps (cooling and heating side)

The above data are referred to the unit without additional optional.

The above data are referred the unit installed in compliancy with installation prescription.

All the data are subject to change without notice. For updated information on project base refer to Chiller Selection Software and unit's certified drawing and wiring diagram

The single pump kit is intended on both water side of the unit including 1 pump for cooling side, 1 pump for heating side.

Dual pump Low lift for models EWYD 400 ÷ 800 XSB2

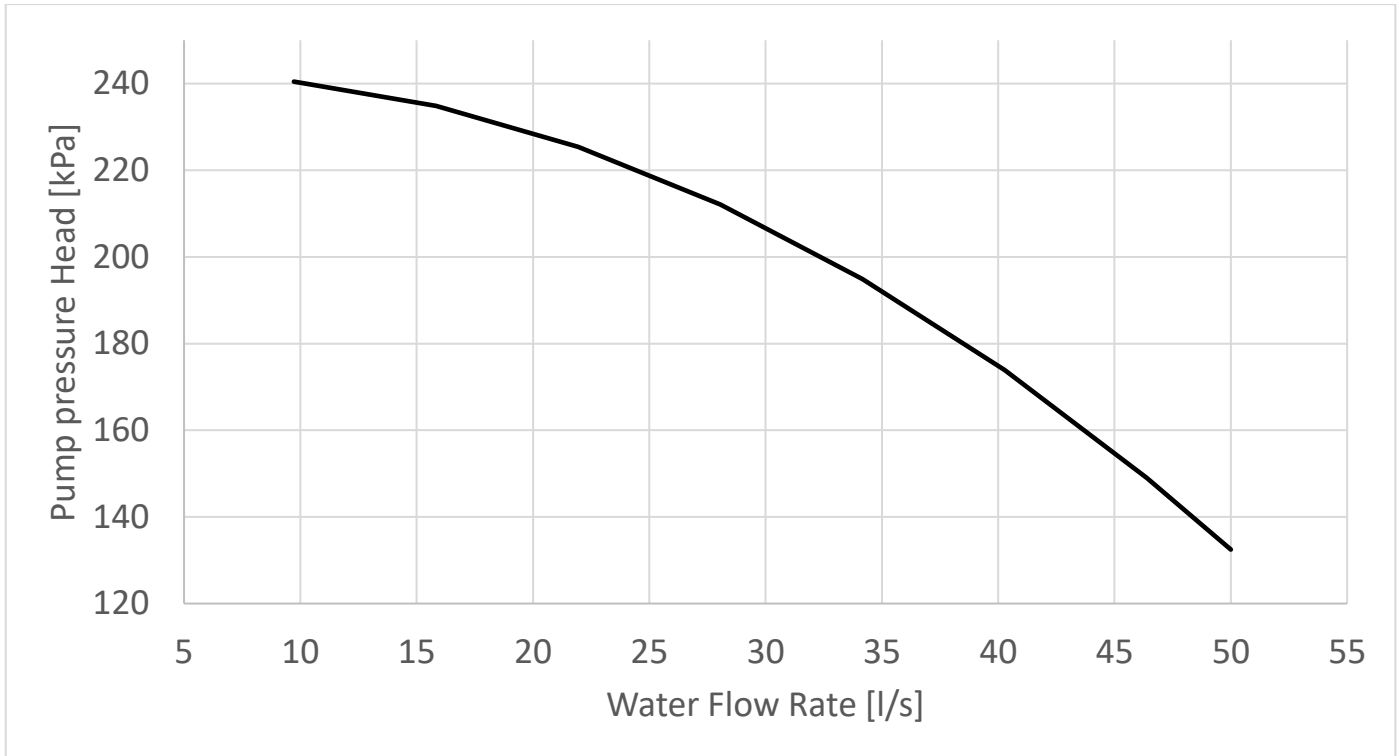

Technical data

EWYD~4ZXSB2 – standard unit								
	Pump motor power input	Pump moto current	Power supply	PN	Motor protection	Insulation class	Available water head @ std condition Cooling (1)	Available water head @ std condition Heating (2)
models	kW	A	V – ph. – Hz	-	-	-	kPa (3)	KPa (3)
400	22	40,4	400 - 3 - 50	10	IP55	F	188	198
450	22	40,4	400 - 3 - 50	10	IP55	F	175	187
500	22	40,4	400 - 3 - 50	10	IP55	F	181	193
550	22	40,4	400 - 3 - 50	10	IP55	F	168	182
600	22	40,4	400 - 3 - 50	10	IP55	F	162	178
650	22	40,4	400 - 3 - 50	10	IP55	F	169	180
700	22	40,4	400 - 3 - 50	10	IP55	F	156	168
800	22	40,4	400 - 3 - 50	10	IP55	F	144	156

- (1) - (standard conditions Air to water - Cooling Only) evaporator water in/out = 12/7°C; ambient = 35.0°C, unit at full load operation in Cooling Only; operating fluid: Water; fouling factor = 0°C/W
- (2) - (standard conditions Air to water - Heating Only) condenser water in/out = 40/45°C; ambient = 7.0°C, unit at full load operation in Heating Only; operating fluid: Water; fouling factor = 0°C/W
- (3) - not including filter pressure drop. The installation of the filter is mandatory.

Note: For calculating the total electrical data of the base unit selected with hydronic kit, the electrical data of the pump must be added to the electrical data of the base unit.

The electrical data refers to both pumps (cooling and heating side)

The above data are referred to the unit without additional optional.

The above data are referred the unit installed in compliancy with installation prescription.

All the data are subject to change without notice. For updated information on project base refer to Chiller Selection Software and unit's certified drawing and wiring diagram

The double pump kit is intended on both water side of the unit including 1 double pump for cooling side, 1 double pump for heating side.

Dual pump High lift for models EWYD 400 ÷ 500 XSB2

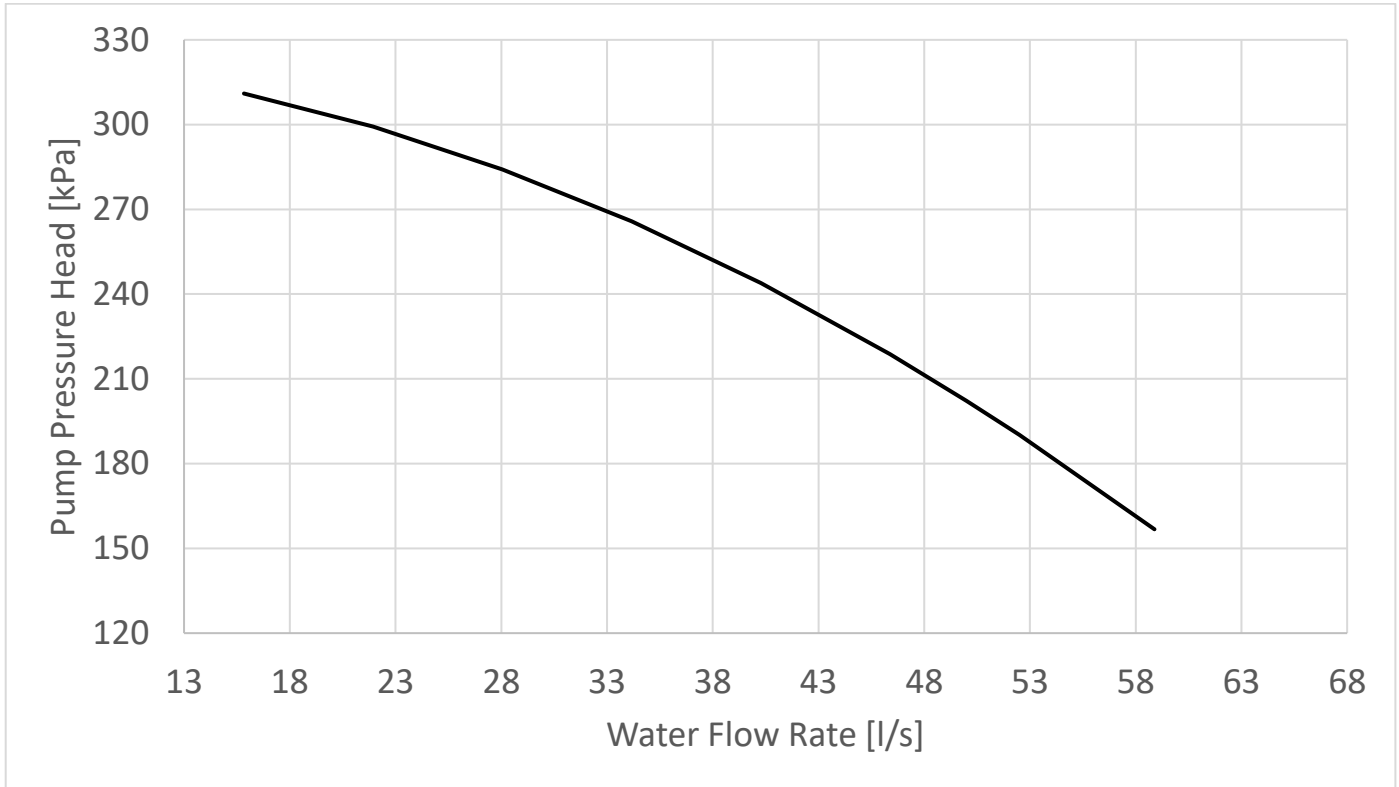

Technical data

EWYD~4ZXSB2 – standard unit								
	Pump motor power input	Pump moto current	Power supply	PN	Motor protection	Insulation class	Available water head @ std condition Cooling (1)	Available water head @ std condition Heating (2)
models	kW	A	V – ph. – Hz	-	-	-	kPa (3)	KPa (3)
400	30	53,2	400 - 3 - 50	10	IP55	F	263	272
450	30	53,2	400 - 3 - 50	10	IP55	F	249	262
500	30	53,2	400 - 3 - 50	10	IP55	F	254	268

- (4) – (standard conditions Air to water - Cooling Only) evaporator water in/out = 12/7°C; ambient = 35.0°C, unit at full load operation in Cooling Only; operating fluid: Water; fouling factor = 0°C/W
- (5) – (standard conditions Air to water - Heating Only) condenser water in/out = 40/45°C; ambient = 7.0°C, unit at full load operation in Heating Only; operating fluid: Water; fouling factor = 0°C/W
- (6) - not including filter pressure drop. The installation of the filter is mandatory.

Note: For calculating the total electrical data of the base unit selected with hydronic kit, the electrical data of the pump must be added to the electrical data of the base unit.

The electrical data refers to both pumps (cooling and heating side)

The above data are referred to the unit without additional optional.

The above data are referred the unit installed in compliancy with installation prescription.

All the data are subject to change without notice. For updated information on project base refer to Chiller Selection Software and unit’s certified drawing and wiring diagram

The double pump kit is intended on both water side of the unit including 1 double pump for cooling side, 1 double pump for heating side.

Dual pump High lift for models EWYD 550 ÷ 800 XSB2

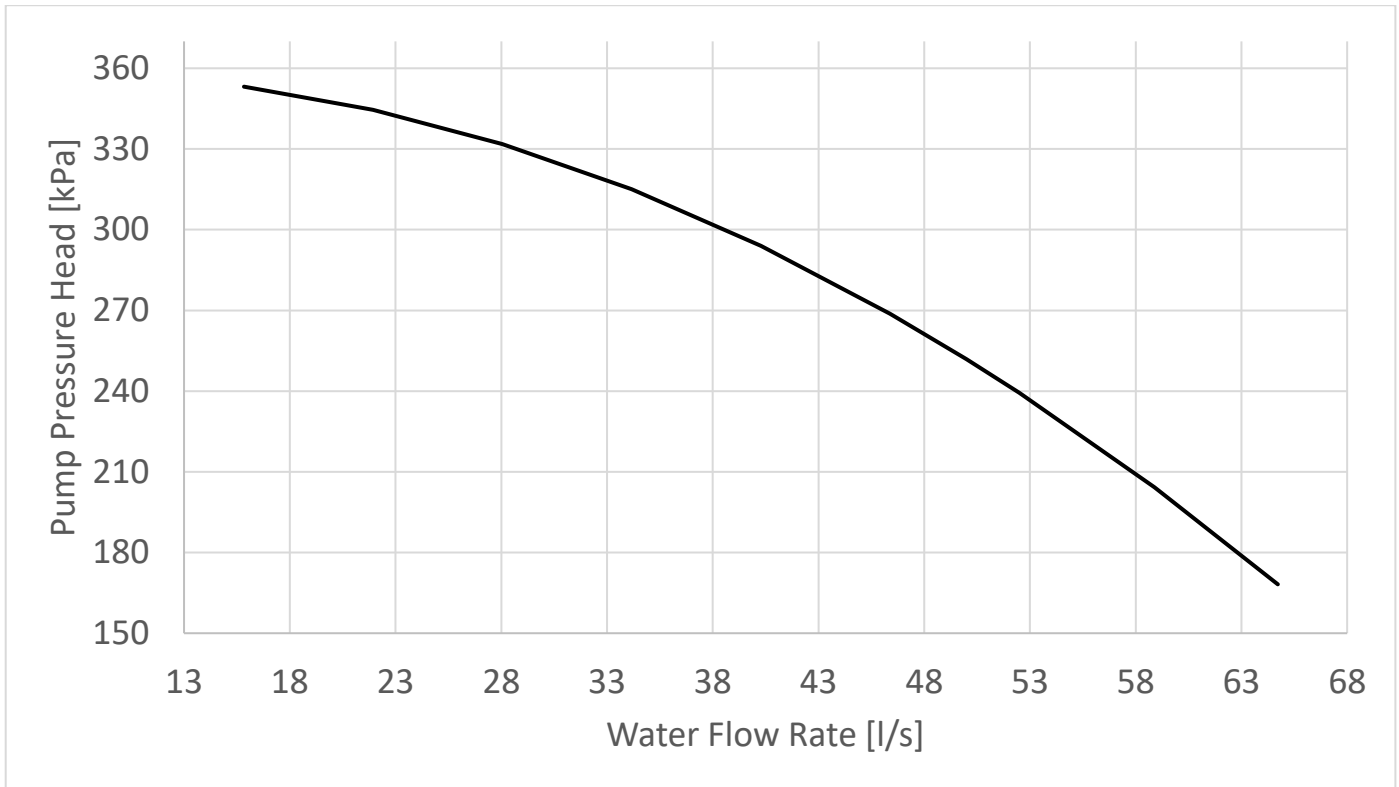

Technical data

EWYD~4ZXSB2 – standard unit								
	Pumps motor power input	Pump moto current	Power supply	PN	Motor protection	Insulation class	Available water head @ std condition Cooling (1)	Available water head @ std condition Heating (2)
models	kW	A	V – ph. – Hz	-	-	-	kPa (3)	KPa (3)
550	37	66	400 - 3 - 50	10	IP55	F	241	255
600	37	66	400 - 3 - 50	10	IP55	F	282	298
650	37	66	400 - 3 - 50	10	IP55	F	289	300
700	37	66	400 - 3 - 50	10	IP55	F	276	288
800	37	66	400 - 3 - 50	10	IP55	F	264	276

- (4) - (standard conditions Air to water - Cooling Only) evaporator water in/out = 12/7°C; ambient = 35.0°C, unit at full load operation in Cooling Only; operating fluid: Water; fouling factor = 0°C/W
- (5) - (standard conditions Air to water - Heating Only) condenser water in/out = 40/45°C; ambient = 7.0°C, unit at full load operation in Heating Only; operating fluid: Water; fouling factor = 0°C/W
- (6) - not including filter pressure drop. The installation of the filter is mandatory.

Note: For calculating the total electrical data of the base unit selected with hydronic kit, the electrical data of the pump must be added to the electrical data of the base unit.

The electrical data refers to both pumps (cooling and heating side)

The above data are referred to the unit without additional optional.

The above data are referred the unit installed in compliancy with installation prescription.

All the data are subject to change without notice. For updated information on project base refer to Chiller Selection Software and unit's certified drawing and wiring diagram

The double pump kit is intended on both water side of the unit including 1 double pump for cooling side, 1 double pump for heating side.

Single pump Low lift for models EWYD 400 ÷ 800 XRB2

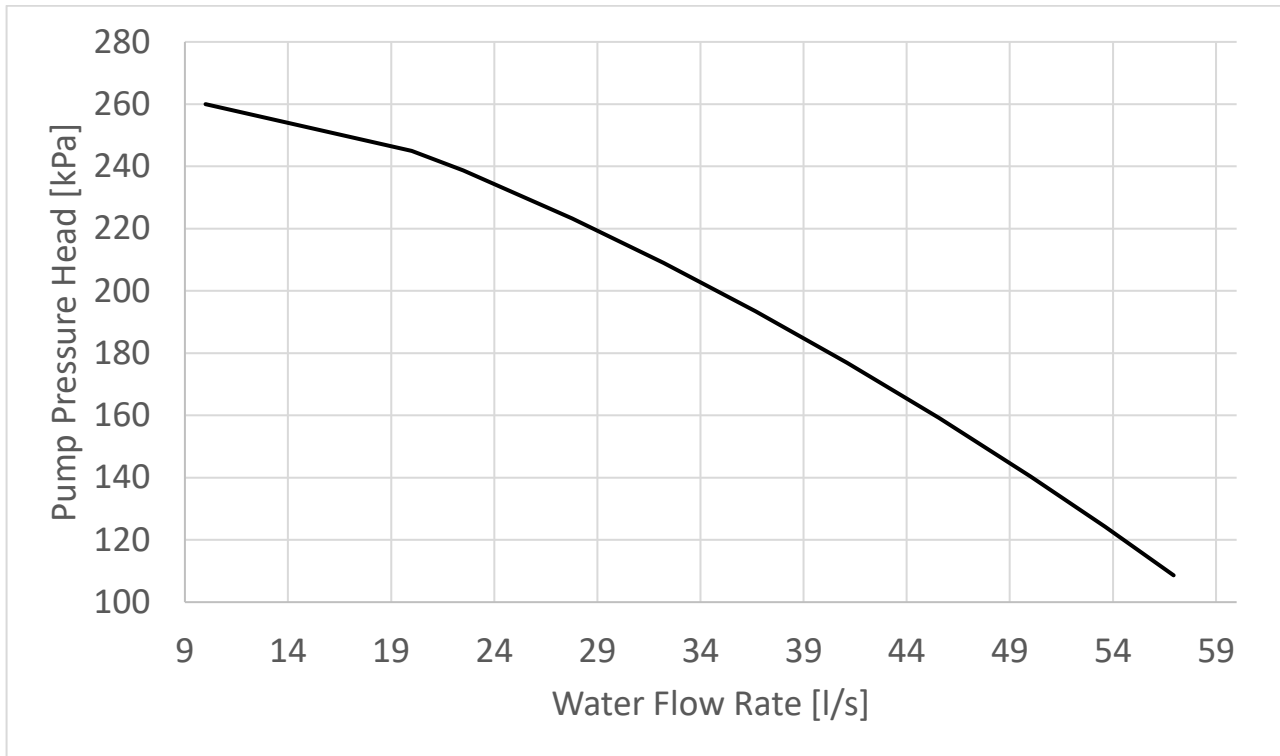

Technical data

EWYD~4ZXRB2 – standard unit								
	Pump motor power input	Pump moto current	Power supply	PN	Motor protection	Insulation class	Available water head @ std condition Cooling (1)	Available water head @ std condition Heating (2)
models	kW	A	V – ph. – Hz	-	-	-	kPa (3)	KPa (3)
400	22	40,4	400 - 3 - 50	10	IP55	F	215	215
450	22	40,4	400 - 3 - 50	10	IP55	F	204	202
500	22	40,4	400 - 3 - 50	10	IP55	F	203	207
550	22	40,4	400 - 3 - 50	10	IP55	F	189	194
600	22	40,4	400 - 3 - 50	10	IP55	F	181	188
650	22	40,4	400 - 3 - 50	10	IP55	F	185	188
700	22	40,4	400 - 3 - 50	10	IP55	F	171	176
800	22	40,4	400 - 3 - 50	10	IP55	F	159	163

(4) - (standard conditions Air to water - Cooling Only) evaporator water in/out = 12/7°C; ambient = 35.0°C, unit at full load operation in Cooling Only; operating fluid: Water; fouling factor = 0°C/W

(5) - (standard conditions Air to water - Heating Only) condenser water in/out = 40/45°C; ambient = 7.0°C, unit at full load operation in Heating Only; operating fluid: Water; fouling factor = 0°C/W

(6) - not including filter pressure drop. The installation of the filter is mandatory.

Note: For calculating the total electrical data of the base unit selected with hydronic kit, the electrical data of the pump must be added to the electrical data of the base unit.

The electrical data refers to both pumps (cooling and heating side)

The above data are referred to the unit without additional optional.

The above data are referred to the unit installed in compliancy with installation prescription.

All the data are subject to change without notice. For updated information on project base refer to Chiller Selection Software and unit's certified drawing and wiring diagram

The single pump kit is intended on both water side of the unit including 1 pump for cooling side, 1 pump for heating side.

Single pump High lift for models EWYD 400 ÷ 500 XRB2

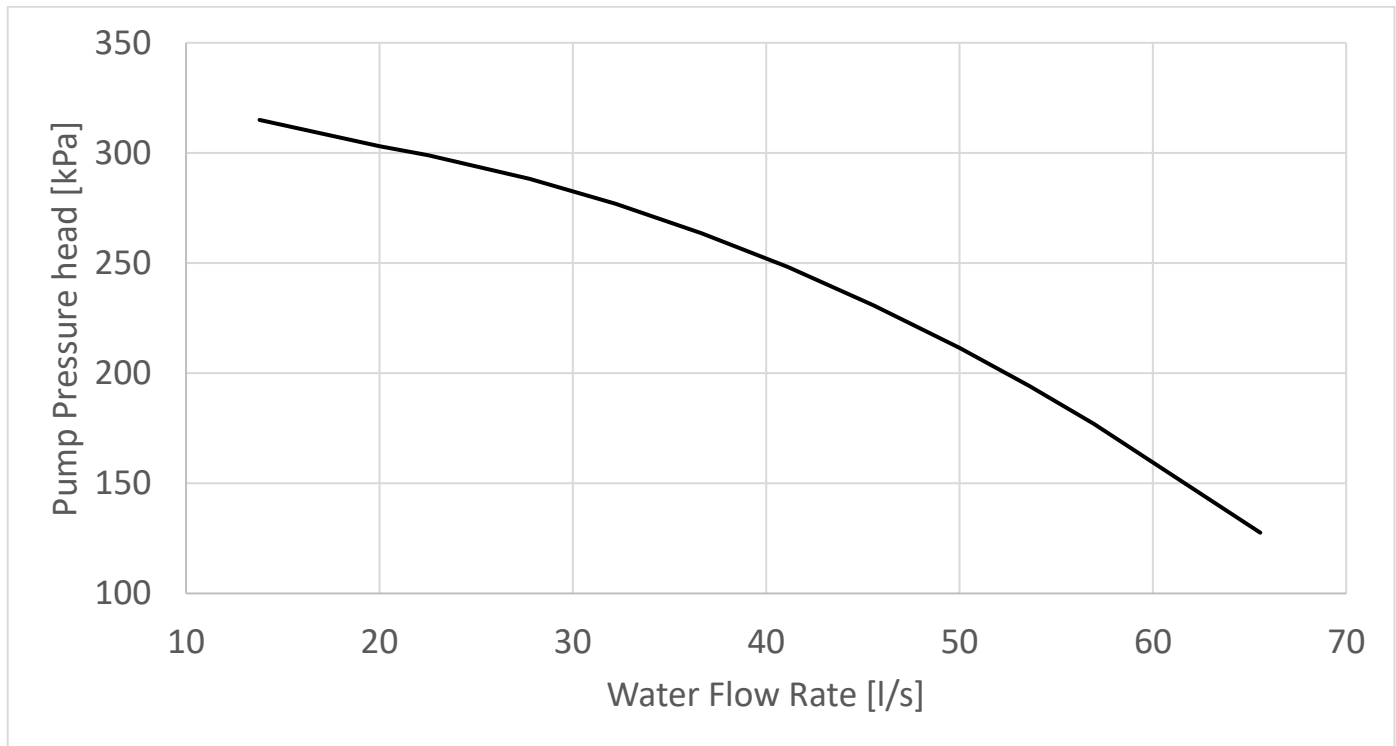

Technical data

EWYD~4ZXRB2 – standard unit								
	Pump motor power input	Pump moto current	Power supply	PN	Motor protection	Insulation class	Available water head @ std condition Cooling (1)	Available water head @ std condition Heating (2)
models	kW	A	V – ph. – Hz	-	-	-	kPa (3)	KPa (3)
400	30	53,2	400 - 3 - 50	10	IP55	F	272	272
450	30	53,2	400 - 3 - 50	10	IP55	F	263	262
500	30	53,2	400 - 3 - 50	10	IP55	F	264	268

- (7) - (standard conditions Air to water - Cooling Only) evaporator water in/out = 12/7°C; ambient = 35.0°C, unit at full load operation in Cooling Only; operating fluid: Water; fouling factor = 0°C/W
- (8) - (standard conditions Air to water - Heating Only) condenser water in/out = 40/45°C; ambient = 7.0°C, unit at full load operation in Heating Only; operating fluid: Water; fouling factor = 0°C/W
- (9) - not including filter pressure drop. The installation of the filter is mandatory.

Note: For calculating the total electrical data of the base unit selected with hydronic kit, the electrical data of the pump must be added to the electrical data of the base unit.

The electrical data refers to both pumps (cooling and heating side)

The above data are referred to the unit without additional optional.

The above data are referred the unit installed in compliancy with installation prescription.

All the data are subject to change without notice. For updated information on project base refer to Chiller Selection Software and unit's certified drawing and wiring diagram

The single pump kit is intended on both water side of the unit including 1 pump for cooling side, 1 pump for heating side.

Single pump High lift for models EWYD 550 ÷ 800 XRB2

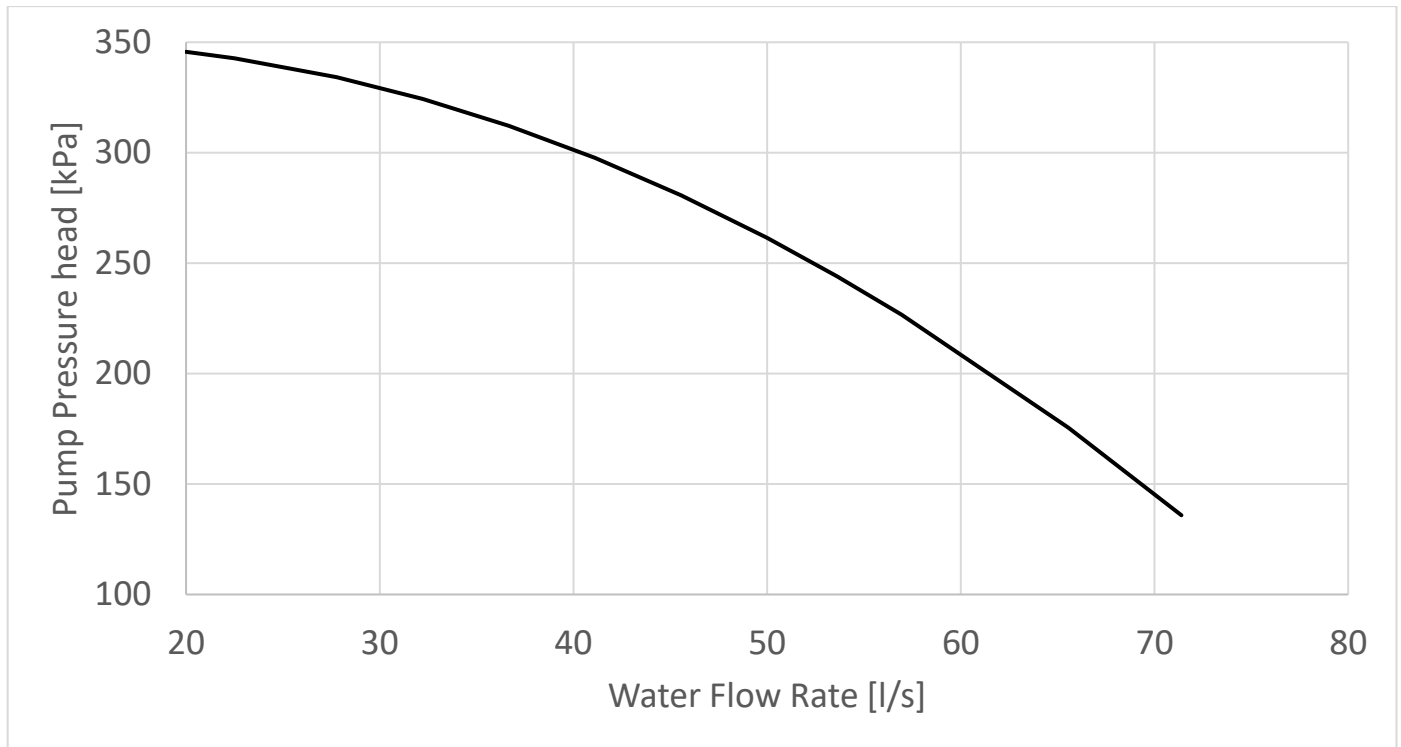

Technical data

EWYD~4ZXRB2 – standard unit								
	Pump motor power input	Pump moto current	Power supply	PN	Motor protection	Insulation class	Available water head @ std condition Cooling (1)	Available water head @ std condition Heating (2)
models	kW	A	V – ph. – Hz	-	-	-	kPa (3)	KPa (3)
550	37	66	400 - 3 - 50	10	IP55	F	253	291
600	37	66	400 - 3 - 50	10	IP55	F	293	332
650	37	66	400 - 3 - 50	10	IP55	F	300	327
700	37	66	400 - 3 - 50	10	IP55	F	287	321
800	37	66	400 - 3 - 50	10	IP55	F	279	307

- (7) – (standard conditions Air to water - Cooling Only) evaporator water in/out = 12/7°C; ambient = 35.0°C, unit at full load operation in Cooling Only; operating fluid: Water; fouling factor = 0°C/W
- (8) – (standard conditions Air to water - Heating Only) condenser water in/out = 40/45°C; ambient = 7.0°C, unit at full load operation in Heating Only; operating fluid: Water; fouling factor = 0°C/W
- (9) - not including filter pressure drop. The installation of the filter is mandatory.

Note: For calculating the total electrical data of the base unit selected with hydronic kit, the electrical data of the pump must be added to the electrical data of the base unit.

The electrical data refers to both pumps (cooling and heating side)

The above data are referred to the unit without additional optional.

The above data are referred the unit installed in compliancy with installation prescription.

All the data are subject to change without notice. For updated information on project base refer to Chiller Selection Software and unit's certified drawing and wiring diagram

The single pump kit is intended on both water side of the unit including 1 pump for cooling side, 1 pump for heating side.

Dual pump Low lift for models EWYD 400 ÷ 800 XRB2

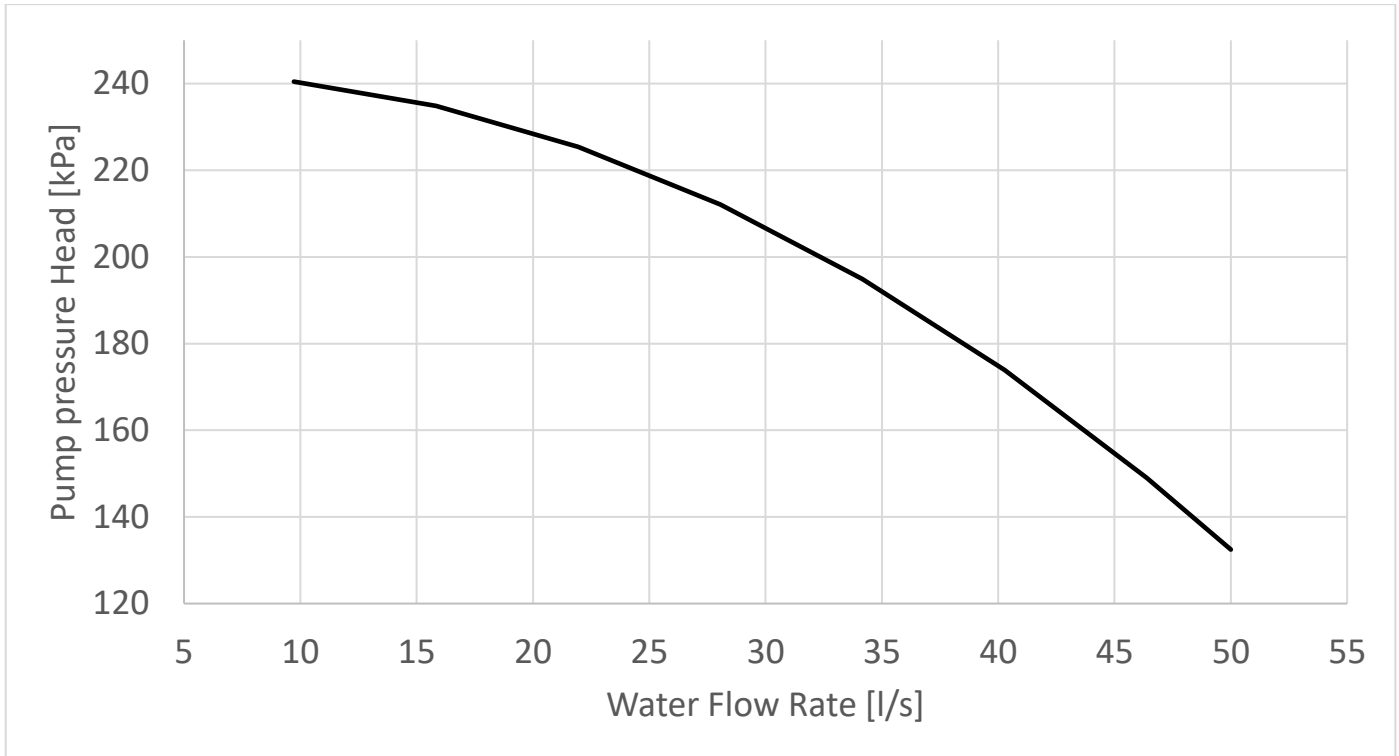

Technical data

EWYD~4ZXRB2 – standard unit								
	Pump motor power input	Pump moto current	Power supply	PN	Motor protection	Insulation class	Available water head @ std condition Cooling (1)	Available water head @ std condition Heating (2)
models	kW	A	V – ph. – Hz	-	-	-	kPa (3)	KPa (3)
400	22	40,4	400 - 3 - 50	10	IP55	F	198	198
450	22	40,4	400 - 3 - 50	10	IP55	F	189	187
500	22	40,4	400 - 3 - 50	10	IP55	F	189	193
550	22	40,4	400 - 3 - 50	10	IP55	F	177	182
600	22	40,4	400 - 3 - 50	10	IP55	F	171	178
650	22	40,4	400 - 3 - 50	10	IP55	F	176	180
700	22	40,4	400 - 3 - 50	10	IP55	F	163	168
800	22	40,4	400 - 3 - 50	10	IP55	F	153	156

- (4) - (standard conditions Air to water - Cooling Only) evaporator water in/out = 12/7°C; ambient = 35.0°C, unit at full load operation in Cooling Only; operating fluid: Water; fouling factor = 0°C/W
- (5) - (standard conditions Air to water - Heating Only) condenser water in/out = 40/45°C; ambient = 7.0°C, unit at full load operation in Heating Only; operating fluid: Water; fouling factor = 0°C/W
- (6) - not including filter pressure drop. The installation of the filter is mandatory.

Note: For calculating the total electrical data of the base unit selected with hydronic kit, the electrical data of the pump must be added to the electrical data of the base unit.

The electrical data refers to both pumps (cooling and heating side)

The above data are referred to the unit without additional optional.

The above data are referred the unit installed in compliancy with installation prescription.

All the data are subject to change without notice. For updated information on project base refer to Chiller Selection Software and unit's certified drawing and wiring diagram

The double pump kit is intended on both water side of the unit including 1 double pump for cooling side, 1 double pump for heating side.

Dual pump High lift for models EWYD 400 ÷ 500 XRB2

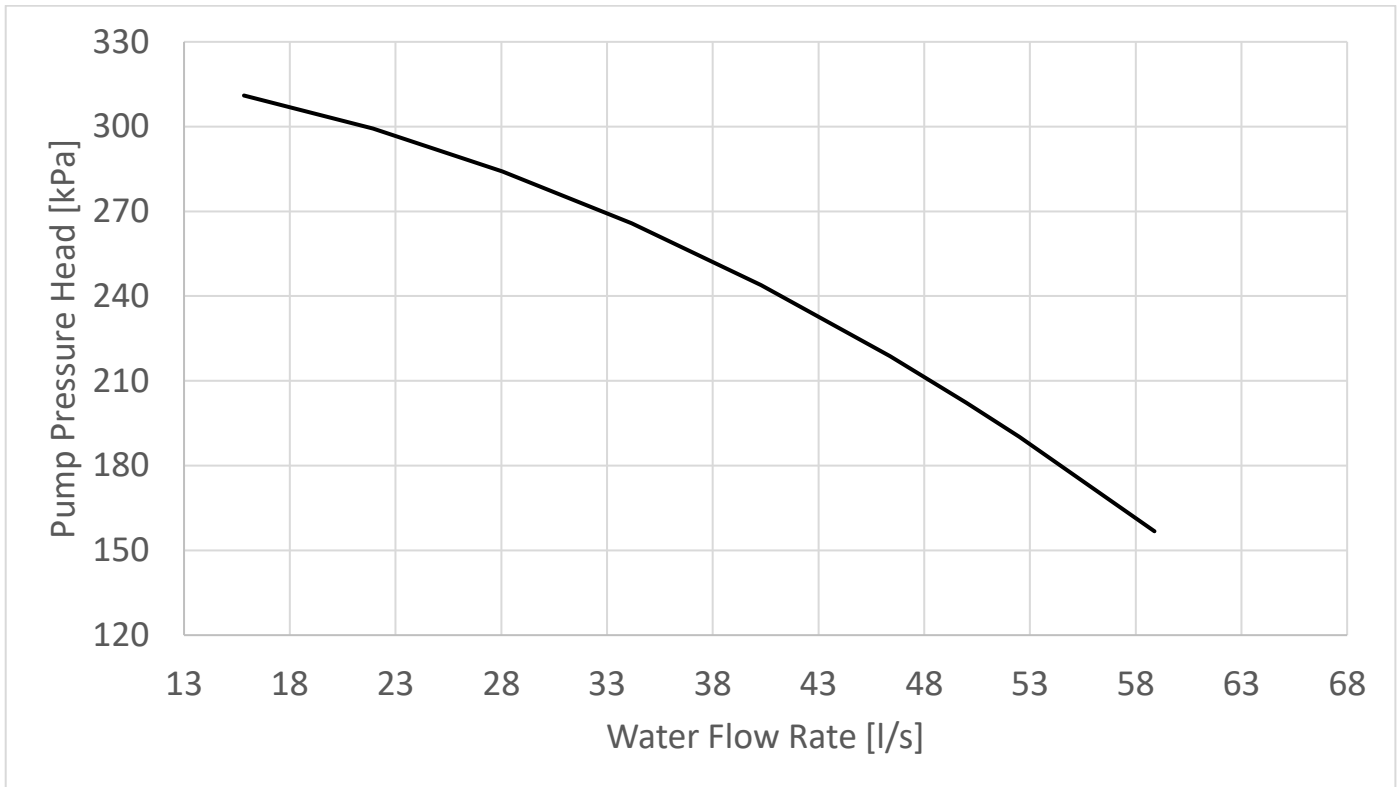

Technical data

EWYD~4ZXRB2 – standard unit								
	Pump motor power input	Pump moto current	Power supply	PN	Motor protection	Insulation class	Available water head @ std condition Cooling (1)	Available water head @ std condition Heating (2)
models	kW	A	V – ph. – Hz	-	-	-	kPa (3)	KPa (3)
400	30	53,2	400 - 3 - 50	10	IP55	F	273	272
450	30	53,2	400 - 3 - 50	10	IP55	F	263	262
500	30	53,2	400 - 3 - 50	10	IP55	F	263	268

(10) – (standard conditions Air to water - Cooling Only) evaporator water in/out = 12/7°C; ambient = 35.0°C, unit at full load operation in Cooling Only; operating fluid: Water; fouling factor = 0°C/W

(11) – (standard conditions Air to water - Heating Only) condenser water in/out = 40/45°C; ambient = 7.0°C, unit at full load operation in Heating Only; operating fluid: Water; fouling factor = 0°C/W

(12) - not including filter pressure drop. The installation of the filter is mandatory.

Note: For calculating the total electrical data of the base unit selected with hydronic kit, the electrical data of the pump must be added to the electrical data of the base unit.

The electrical data refers to both pumps (cooling and heating side)

The above data are referred to the unit without additional optional.

The above data are referred the unit installed in compliancy with installation prescription.

All the data are subject to change without notice. For updated information on project base refer to Chiller Selection Software and unit’s certified drawing and wiring diagram

The double pump kit is intended on both water side of the unit including 1 double pump for cooling side, 1 double pump for heating side.

Dual pump High lift for models EWYD 550 ÷ 800 XRB2

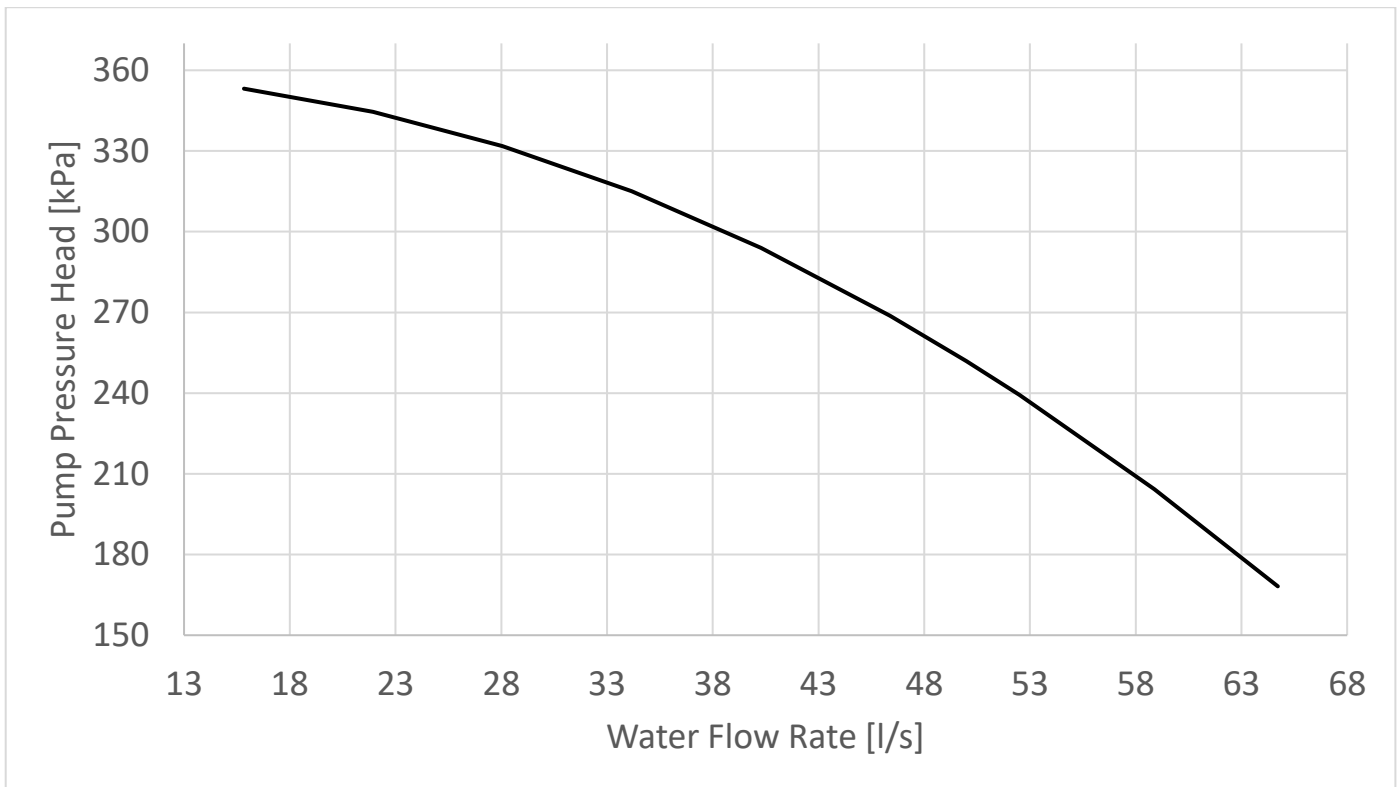

Technical data

EWYD~4ZXRB2 – standard unit								
models	Pumps motor power input kW	Pump moto current A	Power supply V – ph. – Hz	PN -	Motor protection -	Insulation class -	Available water head @ std condition Cooling (1) kPa (3)	Available water head @ std condition Heating (2) KPa (3)
550	37	66	400 - 3 - 50	10	IP55	F	250	255
600	37	66	400 - 3 - 50	10	IP55	F	291	298
650	37	66	400 - 3 - 50	10	IP55	F	296	300
700	37	66	400 - 3 - 50	10	IP55	F	283	288
800	37	66	400 - 3 - 50	10	IP55	F	273	276

(10) – (standard conditions Air to water - Cooling Only) evaporator water in/out = 12/7°C; ambient = 35.0°C, unit at full load operation in Cooling Only; operating fluid: Water; fouling factor = 0°C/W

(11) – (standard conditions Air to water - Heating Only) condenser water in/out = 40/45°C; ambient = 7.0°C, unit at full load operation in Heating Only; operating fluid: Water; fouling factor = 0°C/W

(12) - not including filter pressure drop. The installation of the filter is mandatory.

Note: For calculating the total electrical data of the base unit selected with hydronic kit, the electrical data of the pump must be added to the electrical data of the base unit.

The electrical data refers to both pumps (cooling and heating side)

The above data are referred to the unit without additional optional.

The above data are referred the unit installed in compliancy with installation prescription.

All the data are subject to change without notice. For updated information on project base refer to Chiller Selection Software and unit's certified drawing and wiring diagram

The double pump kit is intended on both water side of the unit including 1 double pump for cooling side, 1 double pump for heating

The hydronic kits are mounted on an additional base frame connected to the standard unit base frame. The length of the unit is increased compared to the standard unit by 1500 mm. In case the inverter kit for pumps is selected the inverters are included in a dedicated electrical box on the additional frame.

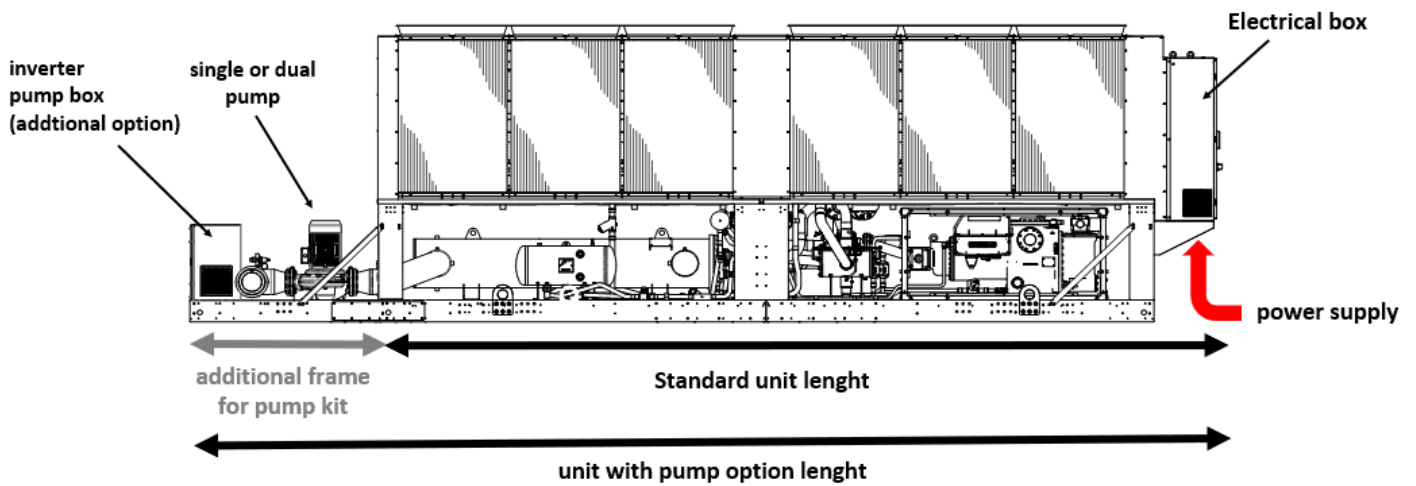

EWYD~4ZXSB2 / EWYD~4ZXR2 with Hydronic kit options									
MODEL		400	450	500	550	600	650	700	800
Unit length	mm	7330	7330	8230	8230	9130	10030	10030	10030

NOTE: All the data are subject to change without notice. For updated information on project base refer to Chiller Selection Software and unit's certified drawing.

The dual pump arrangement consists of 2 sets of dual pumps. The dual pump operation is for 1 pump operating and 1 pump stand-by for each side (cold and hot)

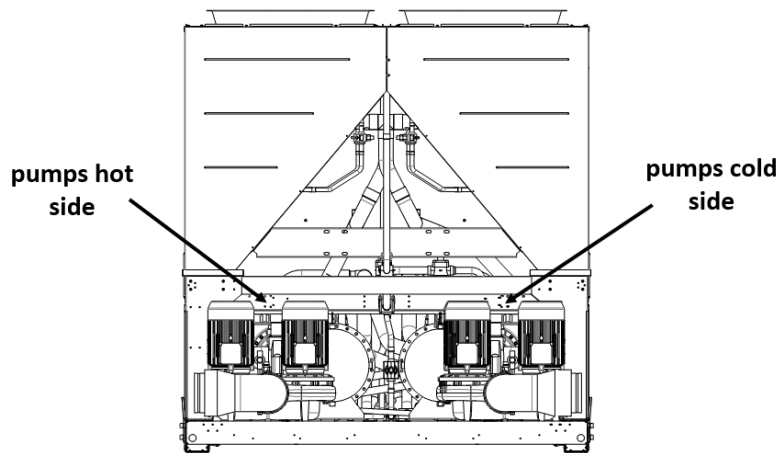

When the Inverter Kit for pump is selected the 1 inverter for each motor pump is provided.

Hydraulic scheme

The below schemes are intended for hot and cold side exchangers:

Unit without hydronic kit

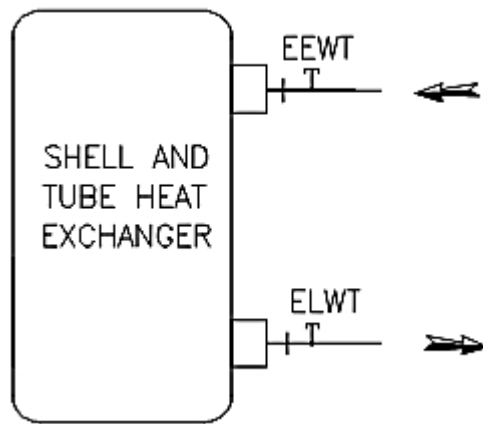

EEWT PROBE	EVAPOR. ENTERING WATER TEMPERATURE	EEWT PROBE	EVAPOR. LEAVING WATER TEMPERATURE
---------------	------------------------------------	---------------	-----------------------------------

Unit with single pump Low/High lift or double pump Low/High lift

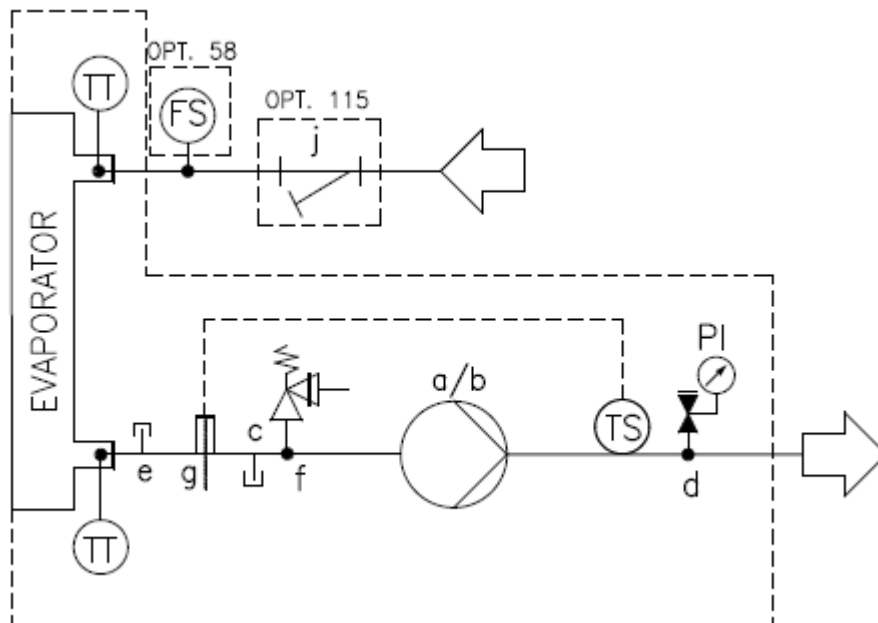

a	SINGLE PUMP (pompa singola)
b	TWIN PUMP (pompa gemellare)
c	DRAIN (manicotto di drenaggio) ½ " NPT
d	AUTOMATIC FILLING VALVE (gruppo di riempimento automatico)
e	PLUGGED FITTING ¼ " NPT
f	SAFETY VALVE (valvola di sicurezza) 10 BAR 1/2"G
g	ELECTRICAL HEATER (immersion) ¾"G 100W 230V
j	WATER FILTER

TT	TEMPERATURE SENSOR (sensore di temperatura)
TS	TEMPERATURE SWITCH (termostato a contatto)
PI	PRESSURE GAUGE (manometro)
FS	FLOWSWITCH (flussostato)

Water piping

The water system must have:

1. Anti-vibration joint to reduce transmission of vibrations to the structures.
2. Isolating valves to isolate the unit from the water system during maintenance.
3. Flow switch.
4. Manual or automatic air venting device at the system's highest point.; drain device at the system's lowest point.
5. A suitable device that can maintain the water system under pressure (expansion tank, etc.).
6. Water temperature and pressure indicators to assist the operator during service and maintenance.
7. A filter or device that can remove particles from the fluid. The installation of the filter is mandatory. The use of a filter extends the life of the evaporator and pump and helps to keep the water system in a better condition.
8. Precautions should be provided to protect the unit against freezing.
9. The heat recovery device must be emptied of water during the winter season, unless an ethylene glycol mixture in appropriate percentage is added to the water circuit.
10. If case of unit substitution, the entire water system must be emptied and cleaned before the new unit is installed. Regular tests and proper chemical treatment of water are recommended after starting up the new unit.
11. If glycol is added to the water system as anti-freeze protection, pay attention to the fact that suction pressure will be lower, the unit's performance will be lower and water pressure drops will be greater. All unit-protection systems, such as anti-freeze, and low-pressure protection will need to be readjusted.
12. Before insulating water piping, check that there are no leaks.

Warning Installation and maintenance of the unit must be performed only by qualified personnel who have knowledge with local codes and regulations, and experience with this type of equipment. Must be avoided the unit installation in places that could be considered dangerous for all the maintenance operations.

Handling Care should be taken to avoid rough handling or shock due to dropping the unit. Do not push or pull the unit from anything other than the base frame. Never allow the unit to fall during unloading or moving as this may result in severe damage. To lift the unit, rings are provided in the base frame of the unit. Spreader bar and cables should be arranged to prevent damage to cabinet.

Location The units are produced for outdoor installation on roofs, floors or below ground level on condition that the area is free from obstacles for the passage of the condenser air. The unit should be positioned on solid foundations and perfectly leveled; in the case of installation on roofs or floors, it may be advisable to arrange the use of suitable weight distribution beams. When the units are installed on the ground, a concrete base at least 250 mm wider and longer than the unit's footprint should be laid. Furthermore, this base should withstand the unit weight mentioned in the technical data table.

Space requirements It is important to respect the minimum distances which guarantee the best ventilation of the condenser coils. Limitations of space reducing the air flow could cause significant reductions in cooling capacity and an increase in electricity consumption.

To determinate unit placement, careful consideration must be given to assure a sufficient air flow across the condenser heat transfer surface. Two conditions must be avoided to achieve the best performance: warm air recirculation and coil starvation. Both these conditions cause an increase of condensing pressures that results in reductions in unit efficiency and capacity. Moreover, the unique microprocessor can calculate the operating environment of the multipurpose unit and the capacity to optimize its performance staying on-line during abnormal conditions.

Each side of the unit must be accessible after installation for periodic service. The following pictures shows you minimum recommended clearance requirements.

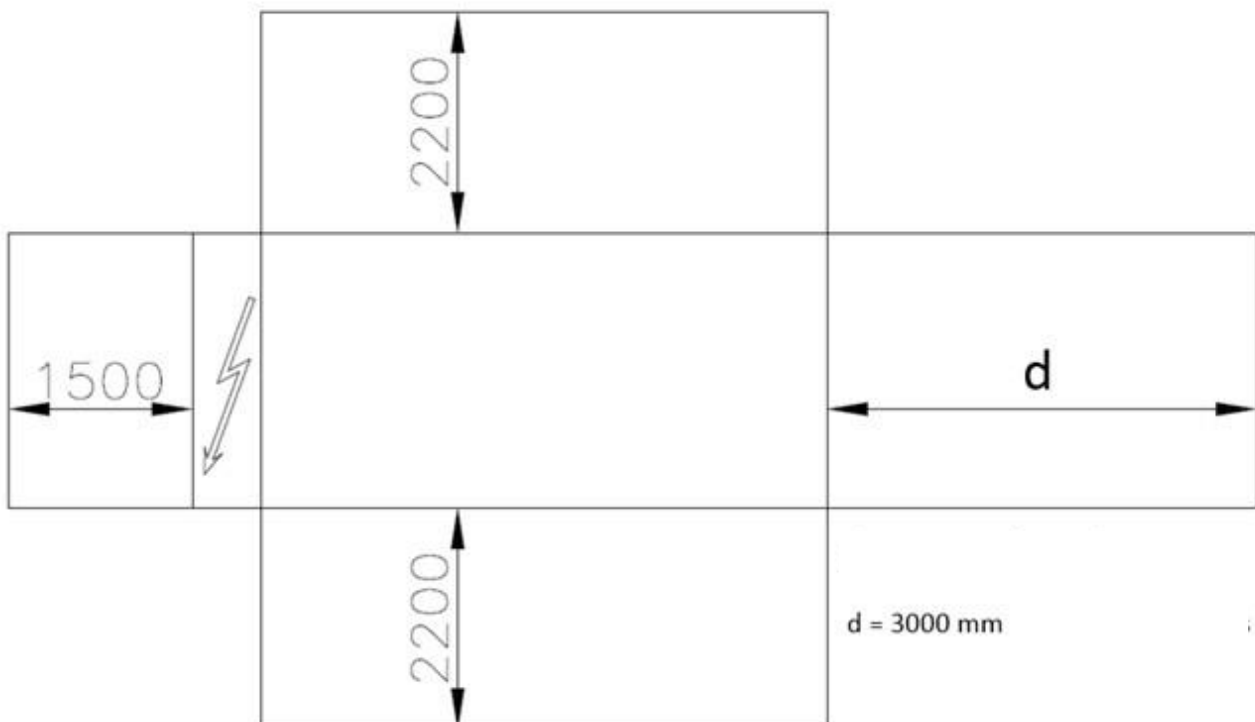

For single unit installation in proximity of a wall the following indications are recommended:

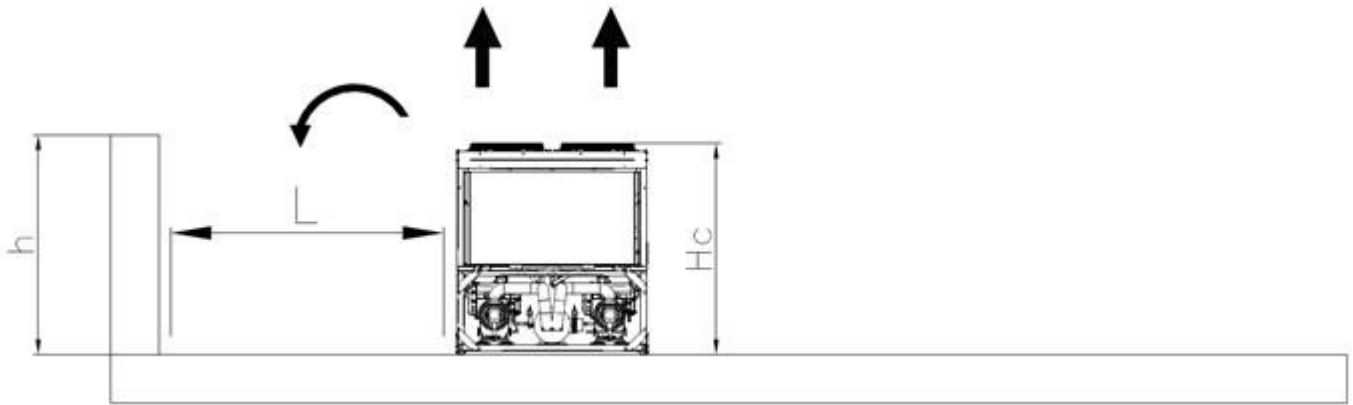

-if $h < H_c$ → L must at least 3 m

-if $h \geq H_c$ or $L < 3$ m contact local Daikin representative to evaluate possible arrangements

In case of two units installed side by side in free filed, the minimum distance recommended is indicated in the below picture

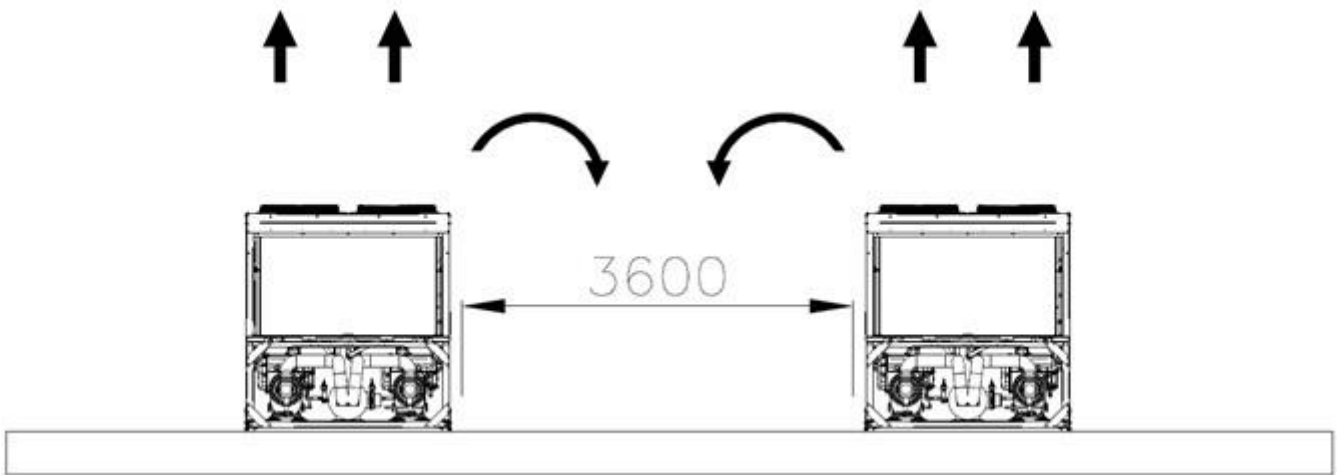

In case of two units installed in a compound contact local Daikin representative to evaluate possible arrangements. For multiple units' installation, it is recommended to install the units in a single row as shown in the below picture

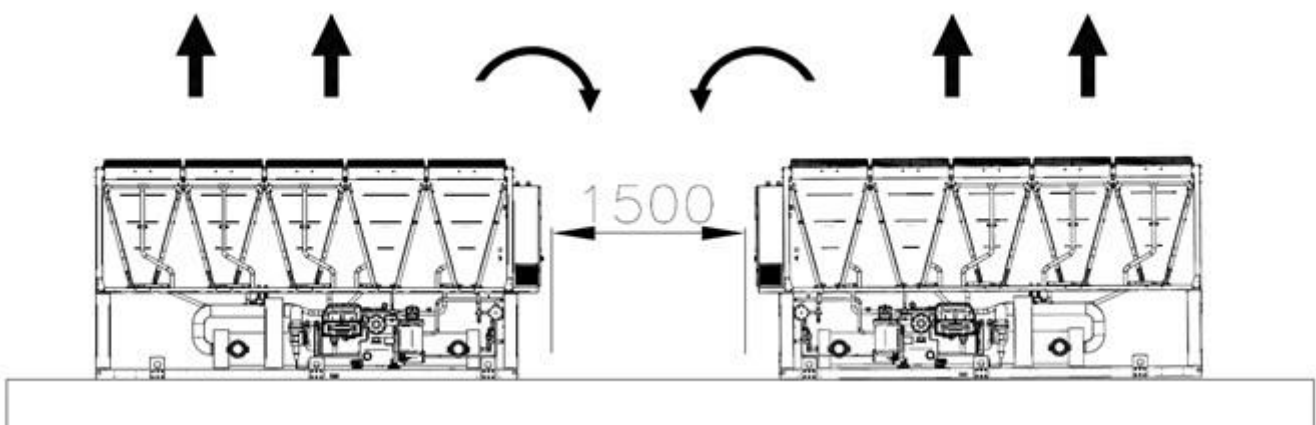

For additional information, refer to the Installation Manual.

If the site does not allow this kind of installation contact Daikin representative to evaluate possible arrangements.

General The unit will be designed and manufactured in accordance with the following European directives:

- Construction of pressure vessel 2014/68/EU
- Machinery Directive 2006/42/EC
- Low Voltage 2014/35/EU
- Electromagnetic Compatibility 2014/30/EU
- Electrical & Safety codes EN 60204-1 / EN 60335-2-40
- Manufacturing Quality Standards UNI – UNI EN ISO 1400
- Environmental Management System UNI EN ISO 14001:2004
- Health & Safety Management System BS OHSAS 18001:2007

To avoid any losses, the unit will be tested at full load in the factory (at the nominal working conditions and water temperatures). The unit will be delivered to the job site completely assembled and charged with refrigerant and oil.

The installation of the unit must comply with the manufacturer’s instructions for rigging and handling equipment.

The unit will be able to start up and operate (as standard) at full load with:

- Outside air temperature from °C to °C
- Cold heat exchanger leaving fluid temperature between °C and °C
- Hot heat exchanger leaving fluid temperature between °C and °C

Refrigerant HFC 134a

Performance Unit shall supply the following performances:

- Number of unit(s): unit(s)

Air to water “Cooling only” mode:

- Cooling capacity for single unit: kW
- Power input for single unit: kW
- Cold heat exchanger entering water temperature: °C
- Cold heat exchanger leaving water temperature: °C
- Cold heat exchanger water flow: l/s
- Nominal outside working ambient temperature: °C
- Minimum full load efficiency (EER): (kW/kW)

Air to water “Heating only” mode:

- Heating capacity for single unit: kW
- Power input for single unit: kW
- Hot heat exchanger entering water temperature: °C
- Hot heat exchanger leaving water temperature: °C
- Hot heat exchanger water flow: l/s
- Nominal outside working ambient temperature: °C
- Minimum full load efficiency (COP): (kW/kW)

Water to water “Cooling + Heating” mode:

- Cooling capacity for single unit: kW
- Heating capacity for single unit: kW
- Power input for single unit: kW
- Cold heat exchanger entering water temperature: °C
- Cold heat exchanger leaving water temperature: °C
- Cold heat exchanger water flow: l/s
- Hot heat exchanger entering water temperature: °C
- Hot heat exchanger leaving water temperature: °C
- Hot heat exchanger water flow: l/s
- Minimum full load efficiency (TER): (kW/kW)

Operating voltage range should be 400V ±10%, 3ph, 50Hz (or 380V ±10%, 3ph, 60Hz), voltage unbalance maximum 3%, without neutral conductor and shall only have one power connection point.

Unit description Unit shall include two independent refrigerant circuits, semi-hermetic type rotary single screw compressors, refrigerant cooled inverter drive for each compressor, electronic expansion device (EEXV), direct expansion shell & tube heat exchangers, air-cooled heat exchanger made with copper tubes and aluminum condenser fins technology, R-134a refrigerant, lubrication system, motor starting components, discharge line shut-off valve, control system and all components necessary for a safe and stable unit operation.

The unit will be factory assembled on a robust base frame made of galvanized steel, protected by an epoxy paint. Each circuit must switch its operating mode between Air to water and Water to water one in less than 1 minute to guarantee the maximum performance in all cooling and heating loads combination.

Sound level and vibrations Sound power level shall not exceeddB(A). The sound power levels must be rated in accordance to ISO 9614 (other types of rating cannot be used). Vibration on the base frame should not exceed 2 mm/s.

Dimensions Unit dimensions shall not exceed following indications:

- Unit length mm
- Unit width mm
- Unit height mm

Compressors

Semi-hermetic, single-screw type with one main helical rotor matching with gate rotor. The gate rotor will be constructed of a carbon impregnated engineered composite material. The gate rotor supports will be constructed of cast iron.

Each compressor shall be fitted with inverter drive for variable capacity control. Inverter shall be integrated within the compressor casing and it shall be cooled by liquid refrigerant.

Each compressor shall be provided with Variable Volume Ratio (VVR) technology. The system shall modify the volumetric compression ratio according to the operating conditions to enhance the efficiency.

The oil injection shall be used to get highest performances also at high condensing pressure and low sound pressure levels in each load condition.

Refrigerant system differential pressure shall provide oil flow through service replaceable, 0.5 micron, full flow, cartridge type oil filter internal to compressor.

Refrigerant system differential pressure shall provide oil injection on all moving compressor parts to correctly lubricate them. Electrical oil pump lubricating system is not acceptable.

The compressor's oil cooling must be realized, when necessary, by refrigerant liquid injection. External dedicated heat exchanger and additional piping to carry the oil from the compressor to heat exchanger and viceversa will be not accepted.

The compressor shall be provided with an integrated, high efficiency, cyclonic type oil separator and with built-in oil filter, cartridge type.

The compressor shall be direct electrical driven, without gear transmission between the screw and the electrical motor.

The compressor casing shall be provided with ports to realize economized refrigerant cycles.

The economizer cycle shall be provided with electronic expansion valve.

The unit shall be provided with two thermal protections realized by a thermistor for high temperature protection: one temperature sensor to protect electrical motor and another sensor to protect unit and lubricating oil from high discharge gas temperature.

The compressor shall be equipped with an electric oil-crankcase heater.

Compressor shall be fully field serviceable. Its removal and return to the factory for service shall be unacceptable.

Capacity control system The unit will have a microprocessor for the control of the compressor capacity through inverter to continuously modulate the compressor's rotational speed.

The unit capacity control shall be infinitely modulating between 100% and the minimum. The unit shall be capable of stable operation to minimum capacity without hot gas bypass.

The unit must be able to follow the loads switching Air to water and Water to water mode in less than 1 minute.

The system shall control the unit based on the leaving water temperature that shall be controlled by PID (Proportional Integral Derivative) logic.

Unit control logic shall manage frequency level of the compressor electric motor to exactly match plant load request to keep constant the set point for delivered chilled or hot water temperature.

The microprocessor unit control shall detect conditions that approach protective limits and take self-corrective action prior to an alarm occurring. The system shall automatically reduce the unit capacity when any of the following parameters are outside their normal operating range:

- High condensing pressure
- Low evaporating refrigerant temperature

Unit-mounted Compressor's Inverter and Electrical Requirement Customer Electrical connection for compressor motor power shall be limited to the main power lead to the single point power connection located into electrical panel.

The Inverter shall be refrigerant cooled. Water cooled or air-cooled inverter cooling are not acceptable.

Base motor frequency shall permit motor to be utilized at nameplate voltage. Adjustable frequency range, monitored by unit's microprocessor control, shall permit a stable unit capacity control down to minimum capacity without hot-gas bypass.

Unit displacement power factor shall be not less than 0.95 on entire unit capacity range, from 100% down to minimum capacity.

Cold heat exchanger The units shall be equipped with a direct expansion shell & tube heat exchanger with copper tubes rolled into steel tube sheets. The heat exchanger shall be single-pass on water side and double pass on refrigerant side. The external shell shall be linked with an electrical heater to prevent freezing down to -28°C ambient temperature, controlled by a thermostat and shall be insulated with flexible, closed cell polyurethane insulation material (20-mm thick). The water side is designed for 10 bar of maximum operating pressure and is provided with vents and drain.

The cold heat exchanger will have 2 circuits, one for each compressor and shall be single refrigerant pass.

The water connections shall be VICTAULIC type connections as standard to ensure quick mechanical disconnection between the unit and the hydronic network.

The cold heat exchanger will be manufactured in accordance to PED approval.

A flow switch on cold heat exchanger is available as option (shipped loose). Water filter is not available as option from the factory. Water filter needs to be provided on the plant.

Hot heat exchanger The units shall be equipped with a direct expansion shell & tube heat exchanger with copper tubes rolled into steel tube sheets. The heat exchanger shall be single-pass on water side and double pass on refrigerant side. The external shell shall be linked with an electrical heater to prevent freezing down to -28°C ambient temperature, controlled by a thermostat and shall be insulated with flexible, closed cell polyurethane insulation material (20-mm thick). The water side is designed for 10 bar of maximum operating pressure and is provided with vents and drain.

The hot heat exchanger will have 2 circuits, one for each compressor and shall be single refrigerant pass.

The water connections shall be VICTAULIC type connections as standard to ensure quick mechanical disconnection between the unit and the hydronic network.

The hot heat exchanger will be manufactured in accordance to PED approval.

A flow switch on cold heat exchanger is available as option (shipped loose). Water filter is not available as option from the factory. Water filter needs to be provided on the plant.

Source side air heat exchanger The air heat exchangers are manufactured with internally enhanced seamless copper tubes arranged in a staggered row pattern and mechanically expanded into lanced and rippled aluminum fins with full fin collars. An integral sub-cooler circuit provides sub-cooling to effectively eliminate liquid flashing and increases cooling capacity without increasing the power input.

Fins are made of aluminum roll pre-coated with a thin layer of baked on acrylic anticorrosion coating prior to the fin stamping process. The treatment consists of a chemical degreasing (basic), a covering process with acrylic anticorrosive middle layer and a covering process with hydrophilic top layer.

The pre-coating material ensures the separation between copper tubes and aluminum fins, breaking the electrical connection and preventing galvanic corrosion, providing also a good protection in mildly corrosive coastal environments with NO impact on performance. When the air heat exchanger operates as evaporator, the hydrophilic layer helps to drain condensation from the coil's surface.

Special treatments ensure enhanced resistance to the corrosion by atmospheric agents extending the life time (available on request).

Fans The fans must be direct propeller type AC Inverter Driven. The material of the blades is glass reinforced resin and each fan is protected by a guard. Fans are installed in a belt-mouth with a diffuser to improve the air flow.

The air discharge shall be vertical and each fan must be coupled to the electrical motor, supplied as standard to IP54 and capable to work to ambient temperatures of - 20°C to + 65°C.

The fans shall have as a standard a thermally protection by internal thermal motor protection and protected by circuit breaker installed inside the electrical panel as a standard.

Refrigerant circuit The unit has two independent refrigerant circuits and one variable electrical frequency driver per compressor (Inverter) with integrated oil separator.

The circuit shall include as standard:

- 3 electronic expansion valves piloted by unit's microprocessor control, one for each operating cycle (Cooling, Heating and Defrost operation);
- compressor discharge shut-off valves;
- economizer circuit with dedicated electronic expansion valve;
- sight glass with moisture indicator;
- replaceable filter drier;
- charging valves;
- high pressure switch;
- high and low pressure transducers;
- oil pressure transducer.

Condensation control The units will be provided with an automatic control for condensing pressure which ensures the working at low external temperatures down to - 18 °C in cooling operation to maintain condensing pressure.

Evaporation control The units will be provided with an automatic control for evaporating pressure which ensures the working at high external temperatures up to +50 °C in heating operation to maintain evaporating pressure.

The compressor automatically unloads when abnormal high or low condensing/evaporating pressure is detected. This to prevent the shutdown of the refrigerant circuit (shutdown of the unit) due to a high/low pressure fault.

Sound unit configurations (on request)

- **Reduced sound configuration:** the noise attenuation is due to decreased fans' speed and compressors' soundproof cabinet especially designed to minimize the sound emissions, enhanced insulations on refrigerant pipe and special connections at the suction of each compressor to reduce drastically the vibrations transmission. This enclosure shall be realized with a light, corrosion resisting aluminum structure and metal panels. The compressor sound-proof enclosure shall be internally fitted with flexible, multi-layer, high density materials.

Hydronic kit options (on request) The hydronic module shall be integrated in the unit chassis and includes the following elements: centrifugal pump with motor protected by a circuit breaker installed in control panel, water filling system with pressure gauge, safety valve, drain valve.

The hydronic module shall be assembled and wired to the control panel.

The water piping shall be protected against corrosion and freezing and insulated to prevent condensation.

Two kinds of hydronic types shall be available:

- in-line single pump
- in-line twin pump.

The unit should be able to operate in Primary only system with two-ways valve on terminals with Variable Primary Flow control strategy (available as option on request).

Master/Slave The unit shall be able to operate in Master / Slave mode to be connected with another similar unit (up to 4). The master unit shall manage the slave units connected in series on the hydraulic plant with the aim of optimizing the running hours of each compressor and enhance the system's efficiency.

Electrical control panel Power and control shall be located in the main panel that will be manufactured to ensure protection against all weather conditions.

The electrical panel shall be IP54 and (when opening the doors) internally protected against possible accidental contact with live parts.

The main panel shall be fitted with a main switch interlocked door that shuts off power supply when opening.

The power section will include compressors and fans protection devices, fans starters and control circuit power supply.

Controller The controller will be installed as standard and it will be used to modify unit set-points and check control parameters.

A built-in display will show unit operating status plus temperatures and pressures of water, refrigerant and air, programmable values, set-points.

A sophisticated software with predictive logic, will select the most energy efficient combination of compressors, EEXV and fans to keep stable operating conditions to maximize unit energy efficiency and reliability.

The controller will be able to protect critical components based on external signals from its system (such as motor temperatures, refrigerant gas and oil pressures, correct phase sequence, pressure switches and cold heat exchanger). The input coming from the high-pressure switch cuts all digital output from the controller in less than 50ms, this will be an additional security for the equipment.

Fast program cycle (200ms) for a precise monitoring of the system.

Floating point calculations supported for increased accuracy in P/T conversions.

Controller main features

Controller shall be guarantee following minimum functions:

- management of the compressor and fans modulation;
- unit enabled to work in partial failure condition;
- full routine operation at condition of:
 - high ambient temperature value;
 - high thermal load;
 - cold heat exchanger high entering water temperature (start-up);
- display of cold/hot heat exchangers' entering/leaving water temperature;
- display of outdoor ambient temperature;
- display of condensing-evaporating temperature and pressure, suction and discharge superheat for each circuit;
- cold/hot heat exchangers' leaving water temperature regulation;
- compressor and heat exchanger pumps hours counter;
- display of status safety devices;
- number of starts and compressor working hours;
- optimized management of compressor load;
- fan management according to condensing pressure;
- re-start in case of power failure (automatic / manual);
- soft load (optimized management of the compressor load during the start-up)
- start at high cold heat exchanger water temperature;
- return reset (set point reset based on return water temperature);
- oat (outside ambient temperature) reset;
- set point reset (optional);

- application and system upgrade with commercial SD cards;
- Ethernet port for remote or local servicing using standard web browsers;
- two different sets of default parameters could be stored for easy restore.
- Master / Slave (provided as standard)
- Variable primary Flow (available as option)
- Two different sets of default parameters could be stored for easy restore.
- High Level Communications Interface (on request)

The unit shall be able to communicate to BMS (Building Management System) based on the most common protocols as:

- ModbusRTU
- LonWorks, now also based on the international 8040 Standard Chiller Profile and LonMark Technology
- BACnet BTP certifies over IP

For more information email info@daikinapplied.uk or visit www.daikinapplied.uk

For all Daikin Applied UK,
Daikin Applied Service &
Spares enquiries call us on:
0345 565 2700



Daikin Europe N.V. participates in the Eurovent Certified Performance programme for Liquid Chilling Packages and Hydronic Heat Pumps, Fan Coil Units and Variable Refrigerant Flow systems. Check ongoing validity of certificate:
www.eurovent-certification.com

The present publication is drawn up by way of information only and does not constitute an offer binding upon Daikin Europe N.V. Daikin Europe N.V. has compiled the content of this publication to the best of its knowledge. No express or implied warranty is given for the completeness, accuracy, reliability or fitness for particular purpose of its content and the products and services presented therein. Specifications are subject to change without prior notice. Daikin Europe N.V. explicitly rejects any liability for any direct or indirect damage, in the broadest sense, arising from or related to the use and/or interpretation of this publication. All content is copyrighted by Daikin Europe N.V.

