

# EWA(H)(D) TZ-C

Air cooled chiller with single screw compressor and variable frequency drive

# Product manual

Available with low GWP refrigerant  
Best performances at full load and part load  
Design for commercial and industrial applications

Refrigerant: 1234ze or 134a

Code	CSS. Rev. 10.19
Date	September 2019

# Table of content

## EWA(H)(D) TZ-C

<b>General characteristics</b>	<b>2</b>		
<b>Nomenclature</b>	<b>13</b>		
<b>Options</b>	<b>14</b>		
Standard options	14		
Options on request	17		
Heat recovery	17		
Hydronic and inverter kits	23		
Variable primary flow	25		
Applications	32		
iCM	36		
<b>Technical specifications performance data</b>	<b>42</b>		
R1234ze standard unit			
Silver series	42		
Gold series	48		
R134a standard unit			
Silver series	54		
Gold series	61		
R1234ze with brushless fans			
Silver series	64		
Gold series	70		
R134a with brushless fans			
Silver series	76		
Gold series	82		
<b>Electrical specifications</b>	<b>88</b>		
R1234ze standard unit			
Silver series	88		
Gold series	94		
R134a standard unit			
Silver series	100		
Gold series	106		
R1234ze with brushless fans			
Silver series	110		
Gold series	116		
R134a with brushless fans			
Silver series	122		
Gold series	126		
R1234ze high ambient kit			
Silver series	134		
Gold series	140		
R134a high ambient kit			
Silver series	146		
Gold series	152		
R1234ze with opt160C -100 Pa ESP			
Silver series	156		
Gold series	162		
R134a with opt160C -100 Pa ESP			
Silver series	168		
		Gold series	174
		R1234ze with opt161B -200 Pa ESP	
		Silver series	178
		Gold series	184
		R134a with opt161B -200 Pa ESP	
		Silver series	190
		Gold series	196
		<b>Sound levels @ 1m</b>	<b>200</b>
		R1234ze standard unit	
		Silver series	200
		Gold series	202
		R134a standard unit	
		Silver series	204
		Gold series	207
		<b>Sound levels @ different distances</b>	<b>208</b>
		R1234ze standard unit	
		Silver series	208
		Gold series	209
		R134a standard unit	
		Silver series	211
		Gold series	212
		<b>Operating limits</b>	<b>213</b>
		Operating envelope	213
		Water quality	217
		Heat recovery	218
		Hydronic kit	220
		<b>Pump curves (technical data)</b>	<b>223</b>
		R1234ze silver series	
		Single pump	223
		Double pump	227
		R1234ze gold series	
		Single pump	231
		Double pump	235
		R134a silver series	
		Single pump	239
		Double pump	241
		R134a gold series	
		Single pump	243
		Double pump	245
		<b>Installation notes</b>	<b>247</b>
		<b>Technical specification</b>	<b>252</b>

**TOP efficiency chillers overachieving the latest requirement on efficiency standards**

EWA(H)(D)~TZ C chiller range is the result of careful design, aimed to optimize the operation and the performance of the chiller for comfort application in all climate conditions with the objective of bringing down operating costs and improving installation profitability, effectiveness and economical management. The chillers feature a high efficiency single screw compressor design driven by Variable Frequency Drive (VFD), large condenser coil surface area for maximum heat transfer and low discharge pressure, high performance condenser fans and a direct expansion 'shell & tube' evaporator with low refrigerant pressure drops.

**NO compromise!**

**Best efficiency at full load and part load operation**

Is a fact that, despite the chiller is selected to satisfy the cooling demand of the plant in worst conditions (meaning highest ambient temperature possible during the cooling season and maximum demand of cooling energy from the plant), in real operation the ambient temperature will be most of the time lower than the design temperature and the cooling demand will be less than the maximum possible.

The indication of "how good a chiller is" cannot be given by full load efficiency energy ratio (EER) but a seasonal efficiency ratio index is needed to proper represent actual operation.

The latest European regulations (entered into force on January 2018) are based on the same concept, setting for Europe minimum efficiency levels based on seasonal operation.

Within the scope of the regulation two different application are identified:

- **Comfort Cooling applications:** seasonal efficiency index is **Seasonal Energy Efficiency Ratio (SEER)**
- **Process Cooling application:** seasonal efficiency index is **Seasonal Energy Performance Ratio SEPR)**

The calculation of the seasonal efficiency indexes is based on an average profile for European countries. For comfort application **SEER** calculation, as defined in EN14825, considers a cooling season of 2600 hours. Assuming 100% cooling demand at 35°C ambient temperature (design temperature) and 0% at 16°C (assumed as Off temperature). Between 35°C and 16°C ambient the cooling demand is calculated based on a linear trend. In the graph below the parameter (BIN and Load) for SEER calculation are represented together with the efficiency of fix speed screw chiller and DAIKIN TZ C at each condition. Despite the efficiency at design condition is similar, the efficiency of DAIKIN TZ C goes up to 130% over the efficiency of the fix speed chiller resulting in much lower operating cost over the cooling season.

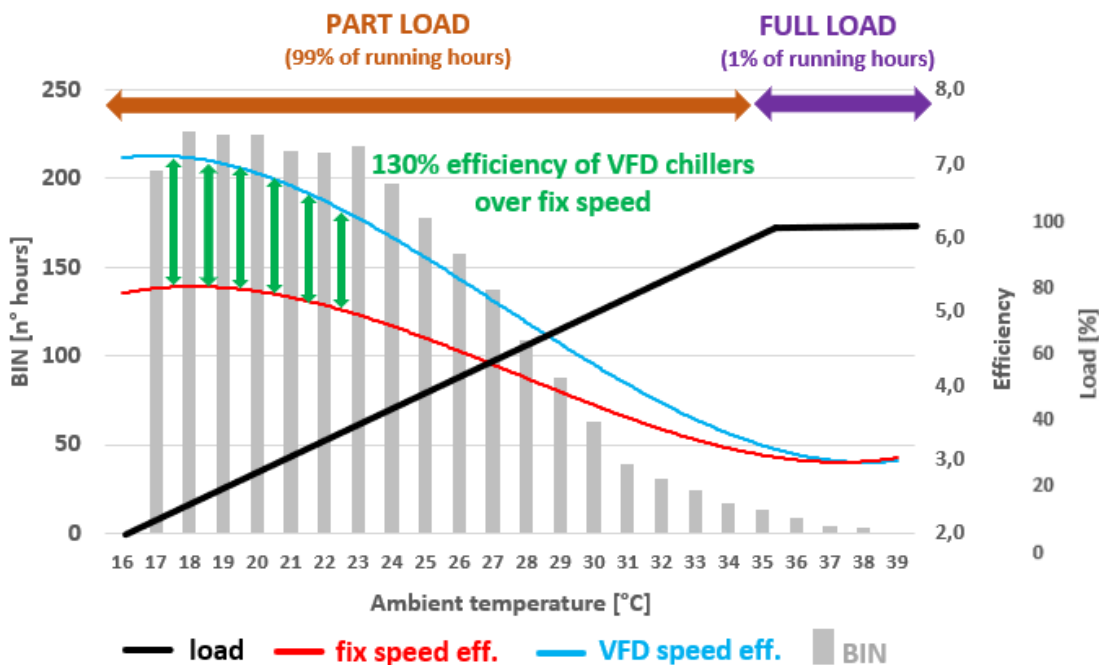

For process application **SEPR** calculation considers a full year operation (8760 hours). Assuming 100% cooling

demand at 35°C ambient temperature (design temperature) and 80% at 5°C (80% is minimum load required for the process). Between 35°C and 5°C ambient the cooling demand is calculated following a linear trend. In the graph below the parameter (BIN and Load) for SEPR calculation are represented together with the efficiency of fix speed screw chiller and DAIKIN TZ C at each condition. Despite the efficiency at design condition is similar, the efficiency of DAIKIN TZ C goes up to 125% over the efficiency of the fix speed chiller resulting in much lower operating cost over the year.

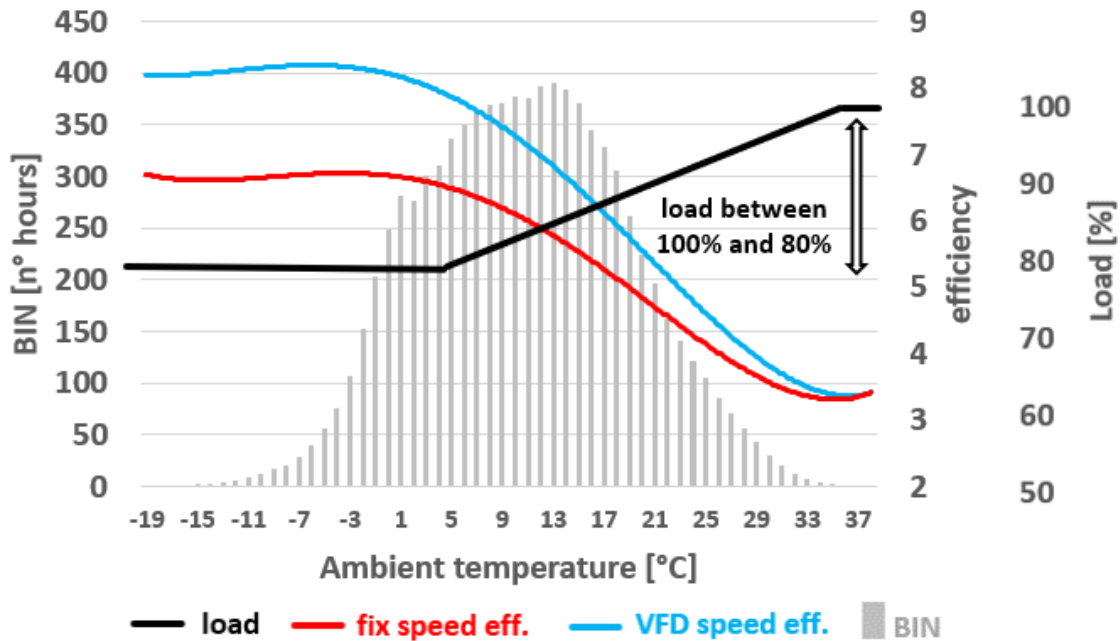

For any application, comfort or process, DAIKIN TZ C achieve the highest efficiency and so the lowest operating costs.

The EWA(H)(D)~TZ C range is available with 2 efficiency levels both with an extensive option list.

**Outstanding reliability** the TZ-C chillers are equipped with a rugged compressor design with advanced composite compressor gate rotors material, a proactive control logic and are full factory- run-tested to optimized trouble-free operation.

The compressor is driven by an inverter integrated on the compressor body and cooled by the refrigerant from the chiller’s circuit. The inverter is designed and manufactured by DAIKIN for this specific application. It is the result of years of experience in inverter application for compressors.

**Superior control logic** The MicroTech III<sup>plus</sup> controller provides an easy to use control environmental. The control logic is designed to provide maximum efficiency, to continue operation in unusual operating conditions and to provide a history of unit operation. One of the greatest benefits is the easy interface with LonWorks, Bacnet, Ethernet TCP/IP or Modbus communications. Integrated sequencing control is provided allowing to connect units (up to 4) operating as a single bigger chiller

**Code requirements – Safety and observant of laws/directives** Units are designed and manufactured in accordance with applicable selections of the following:

Construction of pressure vessel	2014/68/EU
Machinery Directive	2006/42/EU
Low Voltage	2014/35/EU
Electromagnetic Compatibility	2014/30/EU
Electrical & Safety codes	EN 60204-1 / EN 60335-2-40
Manufacturing & Quality Standards	UNI EN ISO 1400

**Certifications** Units are complying with European directives in force, concerning manufacturing and safety. On request units can be produced complying with laws in force in non-European countries, and with other applications, such as naval.



**Compressor** the compressor is semi-hermetic, single-screw type. Design and manufactured by DAIKIN, the new single screw compressor is the result of years of experience and continuous investments in research and development. Specifically, the new DAIKIN single screw compressor is optimized to operate with both R1234ze and R134a refrigerant. The geometry of the compressor itself has been fully redesigned to achieve the highest efficiency at full load (when the all the capacity of the chiller is required) as well as the highest part-load efficiency (much frequent conditions) thanks to the Variable Frequency Drive (VFD) allowing continuous modulation of compressor's rotational speed. The VFD, also design and manufactured by DAIKIN, is integrated in the compressor's body and the electronics inside is cooled by the refrigerant form the chiller's circuit.

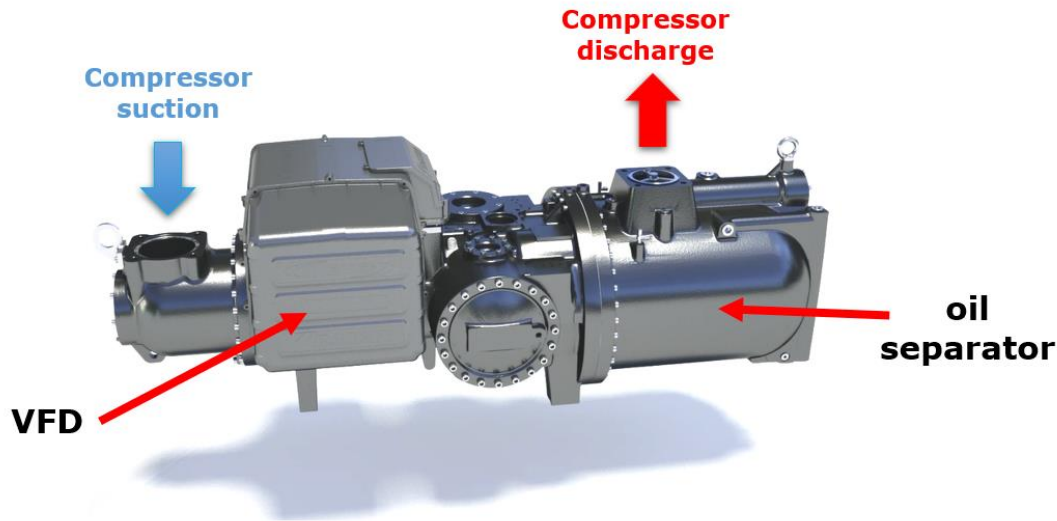

The heat generated by the VFD is dissipated trough an aluminum plate exchanger directly in contact with the electronics. When temperature inside the VFD requires to be lowered some refrigerant is taken from the liquid line of the and, after being expanded, it enters in the aluminum heatsink cooling the inverter electronics. The cold vector is the refrigerant from the chiller, which is not only very effective in remove the heat from the VFD, but it is also always available when the cooling is required.

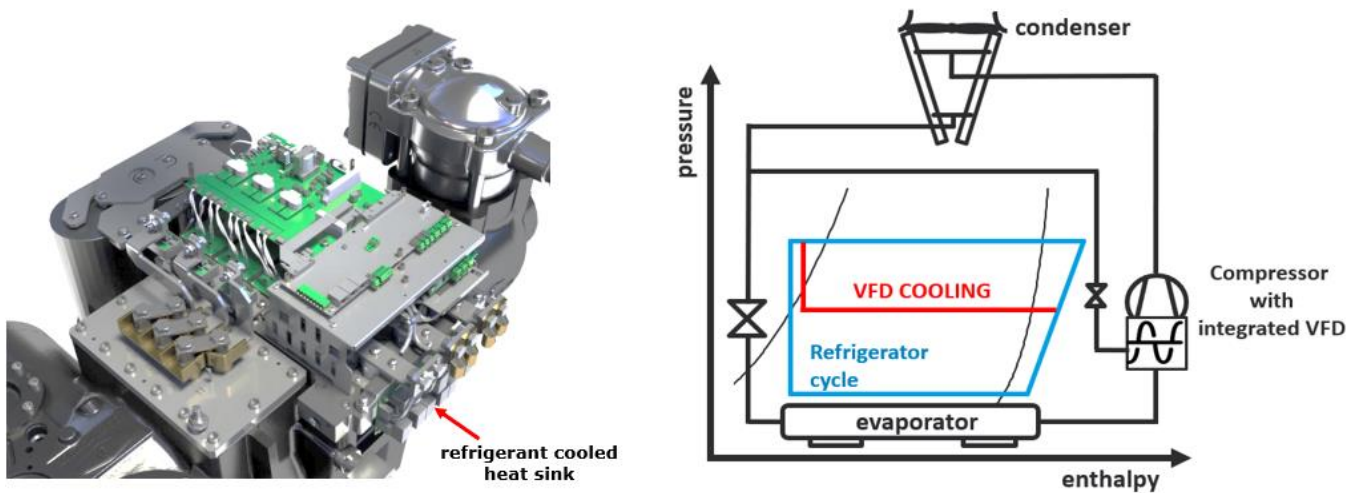

All the components and the connections of the VFD have been specifically engineered to operate properly with the vibration levels determined by the compressor operation. To prove the reliability and the resilience of the VFD an extensive testing campaign has been carried out both in laboratory and on real chiller plant applications.

Most commonly used VFD are air cooled type. In this case the cooling vector is the air from the surroundings. The capacity of the air to cool the VFD depends on his characteristics such as temperature and density. This are influenced by the installation's conditions such as altitude, ambient temperature (which could be affected also by hot air recirculation phenomenon).

## GENERAL CHARACTERISTICS

For this reason, according to the ambient condition, some restrictions must be considered for air cooled VFDs. The power and so the current that the inverter can manage is subject to derating according temperature and altitude as per the graphs below.

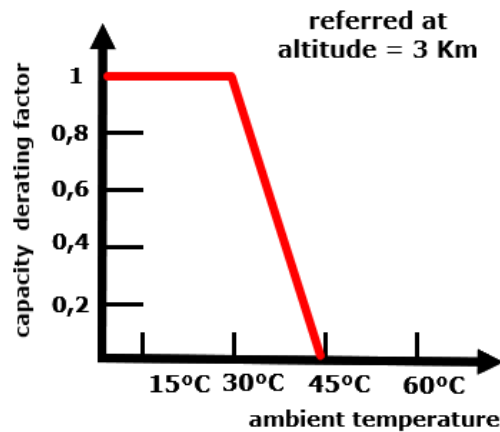
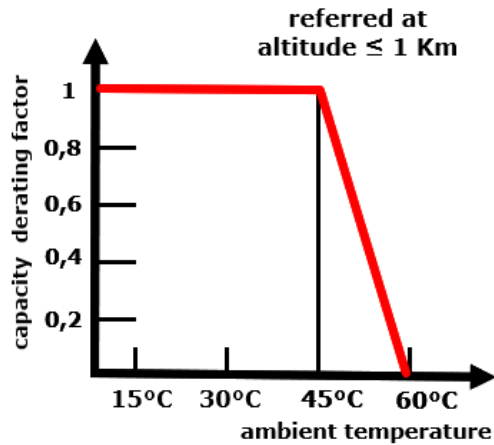

Some applications are provided with glycol cooled VFDs. In that cases the heat from the inverter is removed by glycol mixture moving into a loop between the electrical panel (where the VFD components are) removing the heat and rejecting that heat to the ambient trough a heat exchanger in contact with the ambient air. It is clear also that the effectiveness of this system is influenced by the ambient conditions as well as the direct air-cooled system (it is not possible to have the glycol coolant below the air temperature) with additional complications. The glycol mixture is pushed trough the cooling loop by a dedicated pump which is a sensitive component requiring dedicated maintenance. The glycol mixture quality must stay strictly within the parameters indicate by the supplier otherwise the seals of the pump could be easily corroded.

In case of DAIKIN refrigerant cooled VFD the operation is not affected by the environment conditions such as ambient temperature, altitude or air quality (presence of pollutant, dust or sand)

Technology	Air Cooled	Glycol Cooled	DAIKIN Refrigerant Cooled
Influenced by environmental conditions (temperature, altitude, pollution)	YES	YES	NO
External components needed for the VFD cooling	YES	YES	NO
VFD cooling system needs dedicated maintenance	YES	YES	NO

Massively introduced on the market back in 2013, the VFD developed by DAIKIN is, nowadays, successfully applied in hundreds of chillers installations all over the world.



Installations in:

Europe  
Middle East  
Africa  
Far East  
Oceania  
South America

**Displacement power factor ≥0.95**

The power factor (PF) measures the efficiency of the power delivery. Is equal to the ratio between the real power on the apparent power.

The displacement power factor (DPF) is the power factor due to the phase shift between voltage and current at the fundamental line frequency (50 HZ or 60 Hz). DPF is computed as the cosine of the phase angle between the current and voltage fundamental sine waves. Both give identical results for sinusoidal (non-distorted) voltage and current waveforms. As harmonics are added, the PF gets smaller, but the DPF stays the same.

In case of non-linear loads, the nature of the current changes so that it is no longer sinusoidal. Since the current in these non-linear systems is still periodic (just not sinusoidal), this change for the nature of the current can be described in terms of the harmonic distortion of the current. Each one of the harmonics in the current has an RMS value, so calculation of the RMS current of the whole signal (as you would need to do when calculating power factor) involves summing the RMS value of each harmonic.

In case of non-linear loads (which is the case when Variable Frequency Drive are used) the PF is equal to the DPF multiplied by a "distortion factor" =  $1/(1+THD^2)^{1/2}$  where THD is the total current harmonic distortion.

For TZ C chillers the THD is 35%\*

Note: other distortion's sources in the system, if not previously assessed and filtered, could determine a higher harmonic content and so higher THD.

**Refrigerant** DAIKIN TZC is designed to operate with both R1234ze and R134a. Both are ecological refrigerant with zero ODP (Ozone Depletion Potential) but with different GWP (Global Warming Potential) index. R1234ze and R134a are Greenhouse gases, meaning that they absorb and emit radiant energy within the thermal infrared range. The Greenhouse gases cause the well-known Greenhouse effect. One of the primary greenhouse gases in the atmosphere is carbon dioxide. Basically, greenhouse gases (GHGs) warm the Earth by absorbing energy and slowing the rate at which the energy escapes to space, acting like a blanket insulating the Earth. The Global Warming Potential is a measure of how much energy the emissions of 1 ton of a gas will absorb over a given period (usually 100 years is considered), relative to the emissions of 1 ton of carbon dioxide. The larger the GWP, the more that a given GHG warms the Earth compared to carbon dioxide over that time.

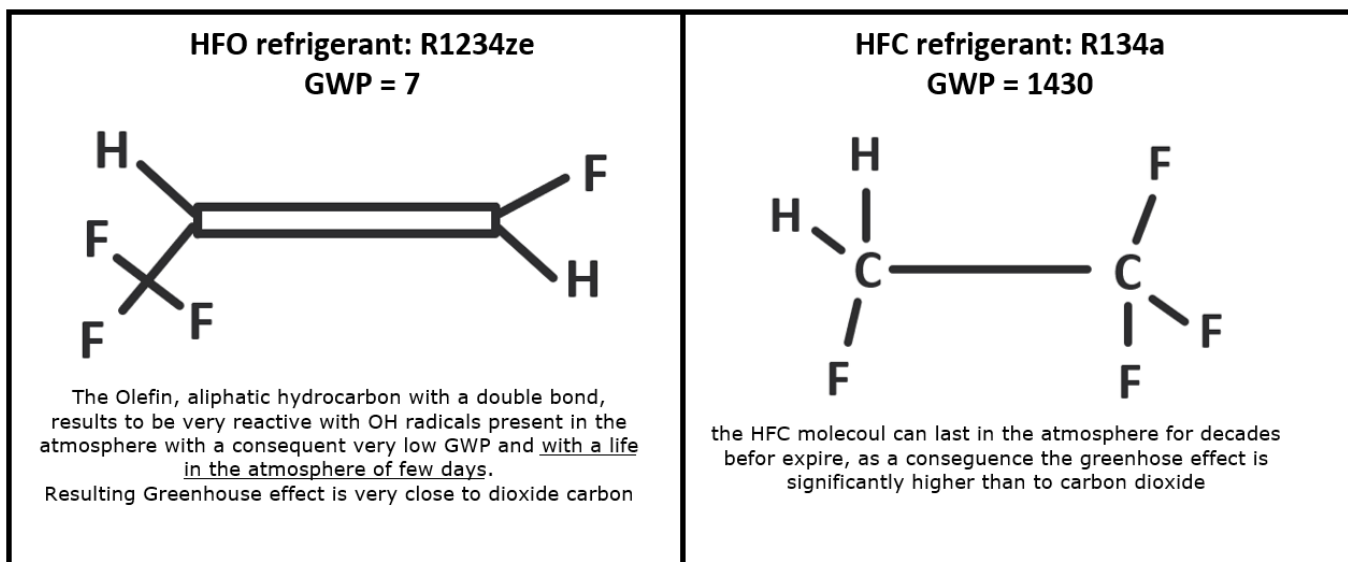

The European Union aims to reduce the environmental impact of fluorinated gases via regulation. The first f-gas regulation EC 842/2006 focused on reducing emissions mostly by preventing leaks in systems and enforcing responsible end-of-life recovery and destruction of these gases. The European Union has recently published an updated F-gas regulation (517/2014). This regulation entered into force from 1st January 2015, replacing the previous version (842/2006) includes among the phase down of HFC refrigerants.

Considering the overall quantity of HFC supplied to Europe in 2015 (100%) the phase down program aims to reduce that quantity down to 21% by 2030. Is important to note that: HFCs refrigerants are not banned but phased down.

DAIKIN TZC is available with both HFO and HFC refrigerant with same efficiency levels and options:

EWAH~TZC models → operating with **R1234ze**

EWAD~TZC models → operating with **R134a**

NOTE: The fourth digit in DAIKIN chillers nomenclature identifies the refrigerant type for the unit. Efficiency levels, options and accessories are the same for both versions of DAIKIN TZ C.

**Additional information related to F-GAS Regulation (EU) No 517/2014 OF THE European Parliament and of the Council of 16 April 2014 on fluorinated greenhouse gases and repealing Regulation (EC) No 842/2006**

Serie	Model	Refrigerant Type	Refrigerant GWP	N° of circuits	Ref. charge circuit #1 [kg]	Ref. charge circuit #1 (TCO2Eq)	Ref. charge circuit #2 [kg]	Ref. charge circuit #2 (TCO2Eq)
EWAH~TZ S- S/L/R C	710	R1234ze(E)	7	2	51	0,4	69	0,5
	770	R1234ze(E)	7	2	51	0,4	69	0,5
	880	R1234ze(E)	7	2	65	0,5	65	0,5
	940	R1234ze(E)	7	2	63	0,4	78	1
	990	R1234ze(E)	7	2	75	0,5	75	1
	H10	R1234ze(E)	7	2	80	0,6	95	1
	C11	R1234ze(E)	7	2	100	0,7	100	1
	C12	R1234ze(E)	7	2	102	0,7	118	1
	C13	R1234ze(E)	7	2	100	0,7	100	1
	C14	R1234ze(E)	7	2	102	0,7	118	1
	C15	R1234ze(E)	7	2	125	0,9	125	1
EWAH~TZ X- S/L/R C	670	R1234ze(E)	7	2	51	0,4	69	0,5
	780	R1234ze(E)	7	2	65	0,5	65	0,5
	840	R1234ze(E)	7	2	63	0,4	78	1
	950	R1234ze(E)	7	2	80	0,6	95	1
	C10	R1234ze(E)	7	2	100	0,7	100	1
	C11	R1234ze(E)	7	2	102	0,7	118	1
	C12	R1234ze(E)	7	2	100	0,7	100	1
	C13	R1234ze(E)	7	2	102	0,7	118	1
	C14	R1234ze(E)	7	2	125	0,9	125	1
	C15	R1234ze(E)	7	2	126	0,9	144	1

Serie	Model	Refrigerant Type	Refrigerant GWP	N° of circuits	Ref. charge circuit #1 [kg]	Ref. charge circuit #1 (TCO2Eq)	Ref. charge circuit #2 [kg]	Ref. charge circuit #2 (TCO2Eq)
EWAD~TZ S- S/L/R C	H11	R134a	1430	2	80	114	95	137
	H12	R134a	1430	2	80	114	95	137
	H13	R134a	1430	2	100	143	100	143
	C15	R134a	1430	2	100	143	100	143
	C16	R134a	1430	2	102	145	118	169
	H17	R134a	1430	2	125	179	125	179
	H18	R134a	1430	2	126	180	144	206
	H19	R134a	1430	2	126	180	144	206
EWAH~TZ X- S/R C	C11	R134a	1430	2	80	114	95	137
	C12	R134a	1430	2	100	143	100	143
	H12	R134a	1430	2	100	143	120	172
	C14	R134a	1430	2	100	143	100	143
	C15	R134a	1430	2	110	157	110	157
	H16	R134a	1430	2	125	179	125	179
	H17	R134a	1430	2	135	193	135	193

**Note: the refrigerant charge is subject to change. Refer to the unit nameplate for actual unit refrigerant charge**

**Base frame and cabinet**

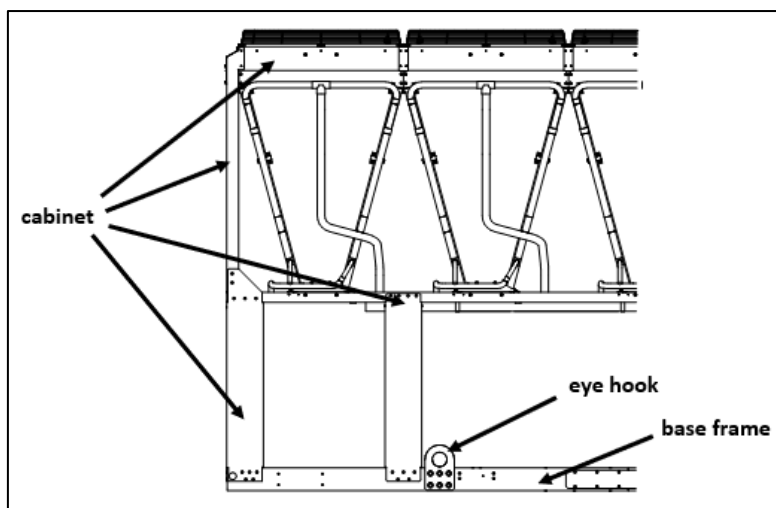

The base frame is made of pickled low carbon steel protected by an anticorrosive epoxy primer, studied to increase the resistance to corrosion of the steel.

The cabinet is made of galvanized steel.

Both base frame and cabinet are protected with anticorrosive paint.

Color Ivory White (Munsell code 5Y7.5/1) ( $\pm$ RAL7044).

The base frame has an eye-hook to lift the unit with ropes for an easy installation. The weight is distributed along the profiles of the base and this facilitates the arrangement of the unit. (refer to dedicated unit's drawing for actual weight distribution).

**Evaporator (Shell & Tube)** The units are equipped with a direct expansion shell & tube evaporator with refrigerant evaporating inside the tubes and water flowing in the shell. The tubes are enhanced for maximum heat transfer and rolled into steel tube sheet and sealed.

The evaporators are single-pass on both refrigerant and water sides for pure counter-flow heat exchange and low refrigerant pressure drops. Both attributes contribute to the heat exchanger effectiveness and total unit's outstanding efficiency.

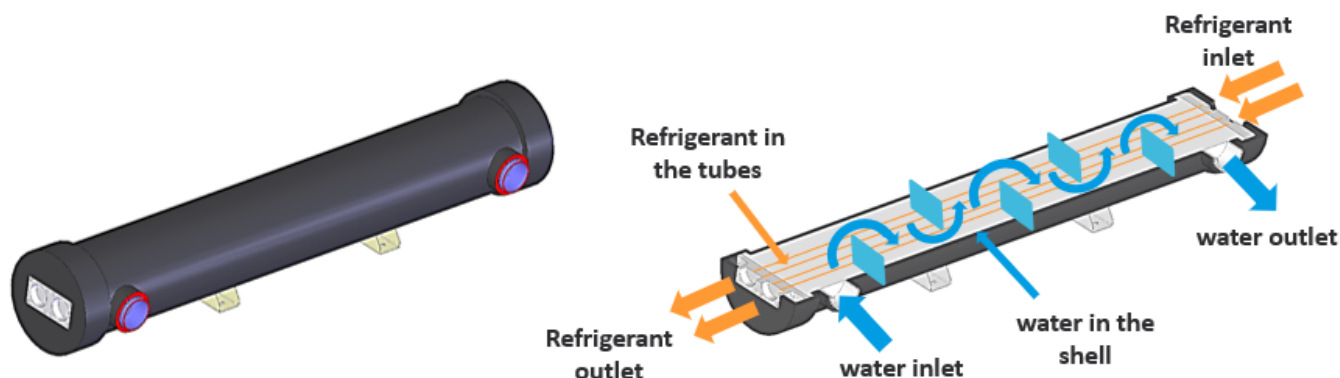

The water side is designed for 10 bar of maximum operating pressure and is provided with vents and drain. The external shell is covered with a 20mm closed cell insulation material and the evaporator water connections are provided with Victaulic kit (as standard). Each evaporator has 2 circuits, one for each compressor and is manufactured in accordance to European standards. Flow switch to detect water flow rate is available as option (shipped loose). Strainers are available as option from the factory. Note: the installation of the strainer is mandatory.

The reduced quantity of refrigerant allowed by using direct expansion type evaporator makes possible for the unit to perform the pump down when stopped storing the refrigerant inside the condensing section. The same is not possible for units equipped with flooded evaporator due to the much higher quantity of refrigerant inside the chiller.

**Electronic expansion valves** the unit is equipped with the most advanced electronic expansion valves to achieve precise control of refrigerant mass flow. As today's system requires improved energy efficiency, tighter temperature control, wider range of operating conditions and incorporate features like remote monitoring and diagnostics, the application of electronic expansion valves becomes mandatory.

Electronic expansion valves possess unique features: short opening and closing time, high resolution, positive shut-off function to eliminate use of additional solenoid valve, continuous modulation of mass flow without stress in the refrigerant circuit and corrosion resistance stainless steel body.

Electronic expansion valves are typically working with lower  $\Delta P$  between high-pressure and low-pressure side, than a thermostatic expansion valve. The electronic expansion valve allows the system to work with low condenser pressure (winter time) without any refrigerant flow problems and with a perfect chilled water leaving temperature control. The economizer circuit is also controlled by an electronic expansion valve.



**Condenser assembly** the condenser assembly is composed of full aluminum heat exchangers and the new fan designed by DAIKIN.

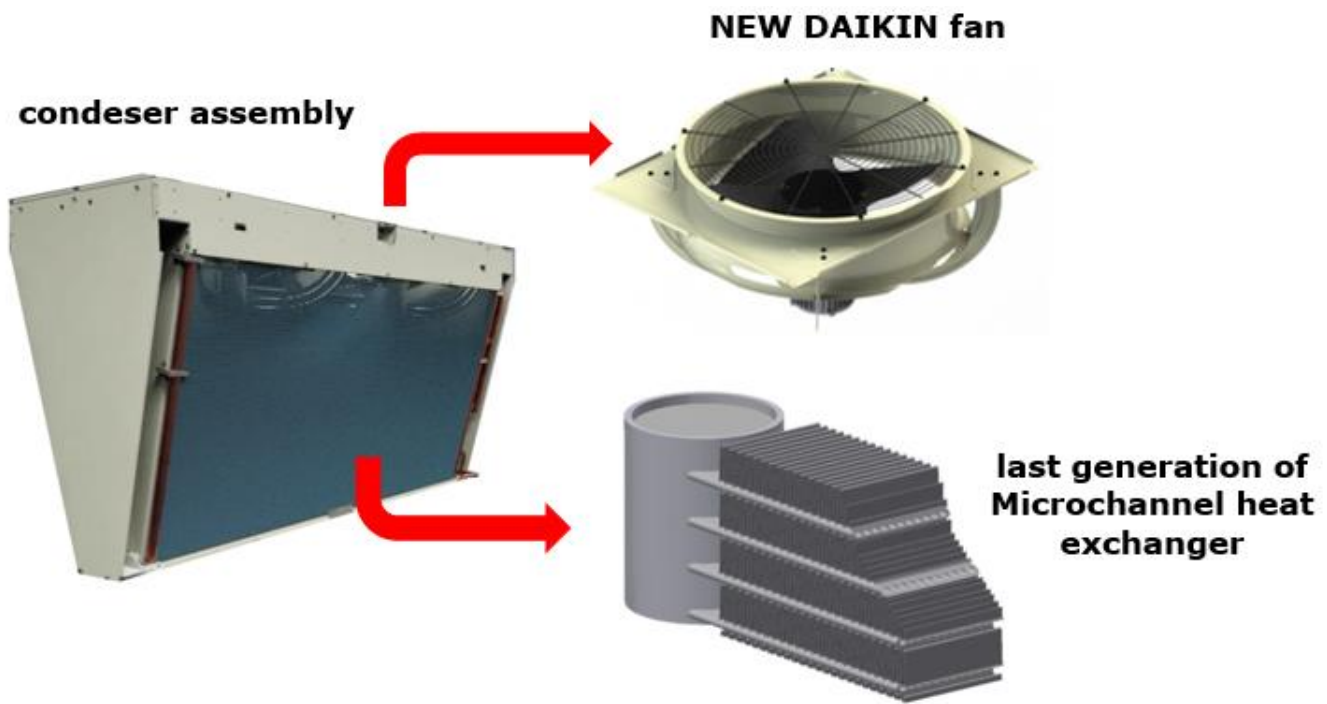

**The condenser fans** are propeller type with high efficiency design blades to maximize performances. The material of the blades is glass-reinforced resin and each fan is protected by a guard. The advanced composite material has been tested to withstand UV light, heat, and humidity corrosion in some of the most severe climates in the world. Fan motors are internally protected from over temperature and are IP54. Insulation class F.



The fans are provided as standard with AC motors, with ON/OFF or INVERTER control according to the version and the options selected. As option is possible to equip the unit with brushless motors for fans. Refer to the option description chapter and price list.

Standard Chiller performances refers to the unit with free discharge (no additional pressure drops on the condenser outlet), without ducts and in observance of the chiller installation prescriptions. As option is possible to equip the unit with powerful fan's motors to ensure proper airflow through the condenser coil with additional pressure drops up to 200 Pa. Refer to Options chapter for more details.

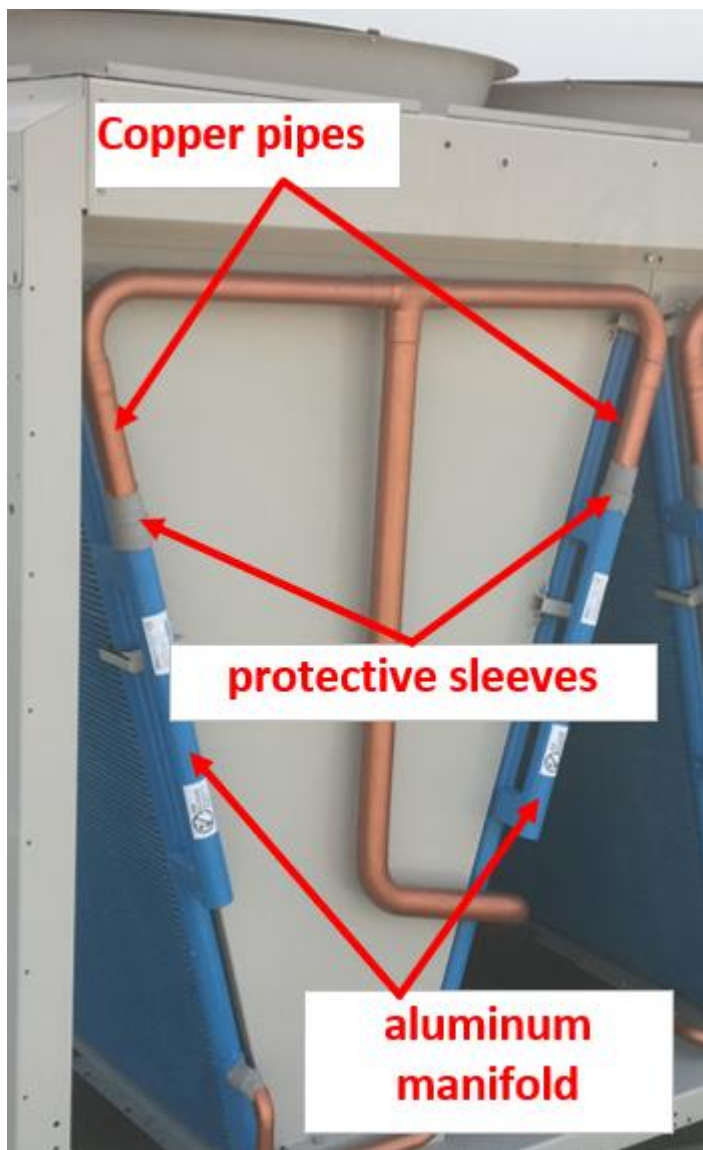

The heat exchangers are made entirely of an aluminum alloy called "Long Life Alloy", Zinc coated fins and multi-port tubes are manufactured with alloys specially developed for this technology and flux brazed in an inert atmosphere to create a homogeneous chemically steady assembly with leak free joints which guarantee improved corrosion resistance. This reduces the risk of galvanic corrosion due to the absence of a bi-metallic couplings with flat tubes containing small channels. Full-depth louvered aluminum fins are inserted between the tubes maximizing the heat exchange. The Microchannel technology ensures the highest performance with the minimum surface for the exchanger. The quantity of refrigerant is also reduced compared to Cu/Al condenser. The full aluminum heat exchangers must be connected to the copper pipes of chiller's refrigerant circuit. It is fundamental to protect the Cu/Al joints against the galvanic corrosion. As a result of this experience and after a deep and thorough analysis of all the connection protectors available in the market, we have introduced the latest improvement, the adhesive sleeve + polyurethane-based sealing protector.

Special treatment on the aluminum ensures resistance to the corrosion by atmospheric agents extending the life time.

Note: for application in industrial, coastal high polluted urban environment or combinations of the above a proper evaluation is needed to understand if, according to the specific environment, additional protection measures are needed. Refer to Options chapter for more details.

**Refrigerant circuit** Each unit has 2 independent refrigerant circuits and each one includes:

- Compressor with integrated oil separator
- Refrigerant
- Evaporator
- Air Cooled Condenser
- Electronic expansion valve
- Discharge line shut off valve
- Sight glass with moisture indicator
- Filter drier
- Charging valves
- High pressure switch
- High pressure transducers
- Low pressure transducers
- Oil pressure transducer
- Suction temperature sensor

**Electrical control panel** Power and control are located in the main panel that is manufactured to ensure protection against all weather conditions. The electrical panel is IP54 and (when opening the doors) internally protected against possible accidental contact with live parts. The main panel is fitted with a main switch interlocked door that shuts off power supply when opening.

**Power Section** The power section includes compressors and fans protection devices, fans starters and control circuit power supply.

### MicroTech 4 controller

The new MicroTech 4 controller is installed as standard in all Daikin chillers.

It gives the possibility to check the most relevant control parameters and modify unit set-points. A built-in display shows unit operating status. Additionally, temperatures and pressures of water, refrigerant and air, programmable values, set-points can be accessed based on a preset list of user profiles.

A sophisticated software with adaptive logic, selects the most energy efficient combination of compressors, EEXV and fans to keep stable operating conditions to maximize unit energy efficiency and reliability. MicroTech 4 protects critical components based on external signals from onboard sub-system (such as motor temperatures, refrigerant and oil pressures and temperatures, correctness of phase sequence, pressure switches and freezing of heat exchanger).

The input coming from high-pressure switches cuts all digital output from the controller in less than 50ms, as an additional security for the equipment. Fast program cycle (less than 200ms) for a precise monitoring of the system and sub-systems. Floating point calculations supported for increased accuracy in Pressure / Temperature conversions.

### Control main features

Control system has the following feature:

Management of compressors and fans modulation;

Control of cooling or heating leaving water temperatures;

Management of cooling and heating capacities according to the load;

Switch of operating modes in less than 1 minute;

Return reset (set point reset based on return water temperature);

- Set point reset (optional);
- Unit operation in partial failure condition;
- Managed operations during critical conditions:
  - High ambient temperature;
  - High thermal load;
  - Startup with high and low differential operating conditions;
  - Startup with high entering water temperature in cooling mode;
  - Startup with low entering water temperature in heating mode;
- Optimized management of compressor load;
- Optimized fan management according to condensing pressure;
- General faults alarm relay;
- Automatic re-start in case of power failure;
- Rapid Restart to recover full load in the shortest possible time for Data Centre application;
- ICM Standard control for multiple chillers management;
- Soft load (optimized management of the compressor load during the start-up);
- Start at high cold heat exchanger water temperature;
- Visualization of:
  - cooling and heating entering/leaving water temperature of heat exchangers;
  - outdoor ambient temperature;
  - condensing-evaporating temperature and pressure, suction and discharge superheat for each circuit;
  - hours and starts counter for compressors and pumps;
  - status safety devices;

### Control additional features

- System upgrade with commercial SD cards;
- Save/Restore of configuration parameters with a commercial SD card;
- Ethernet port for remote or local servicing using standard web browsers;
- Daikin on Site connectivity for cloud based services



**Safety device / logic for each refrigerant circuit**

The following devices / logics are available:

- high pressure (pressure switch);
- high pressure (transducer);
- low pressure (transducer);
- fans circuit breakers;
- high compressor discharge temperature;
- high motor winding temperature;
- phase monitor;
- low pressure ratio;
- high oil pressure drops;
- low oil pressure;
- no pressure changes at start.

**System security**

The following securities are available:

- phase monitor;
- low ambient temperature lock-out;
- freeze protection.

**Regulation type**

Proportional integral derivative regulation on the cold heat exchanger leaving water output probe.

**MicroTech 4**

MicroTech 4 built-in terminal has the following features:

- Liquid crystal display with white back lighting, supports Unicode fonts for multi-lingual;
- Key-pad consisting of 3 keys;
- Push'n'roll control for an increased usability;
- Flash memory to protect the data;
- Password access to modify the setting;
- Application security to prevent application tampering or hardware usability with third party applications;
- Alarm history memory to allow an easy fault analysis.

**Supervising systems (on request) MicroTech 4 remote communication**

MicroTech 4 can communicate to BMS (Building Management System) based on the most common protocols as:

- ModbusRTU (Native);
- LonWorks,
- BACnet BTP certified over IP and MS/TP (class 4) (Native);
- Ethernet TCP/IP (Native).

## Nomenclature

**EWA H 900 T Z X S C 2**

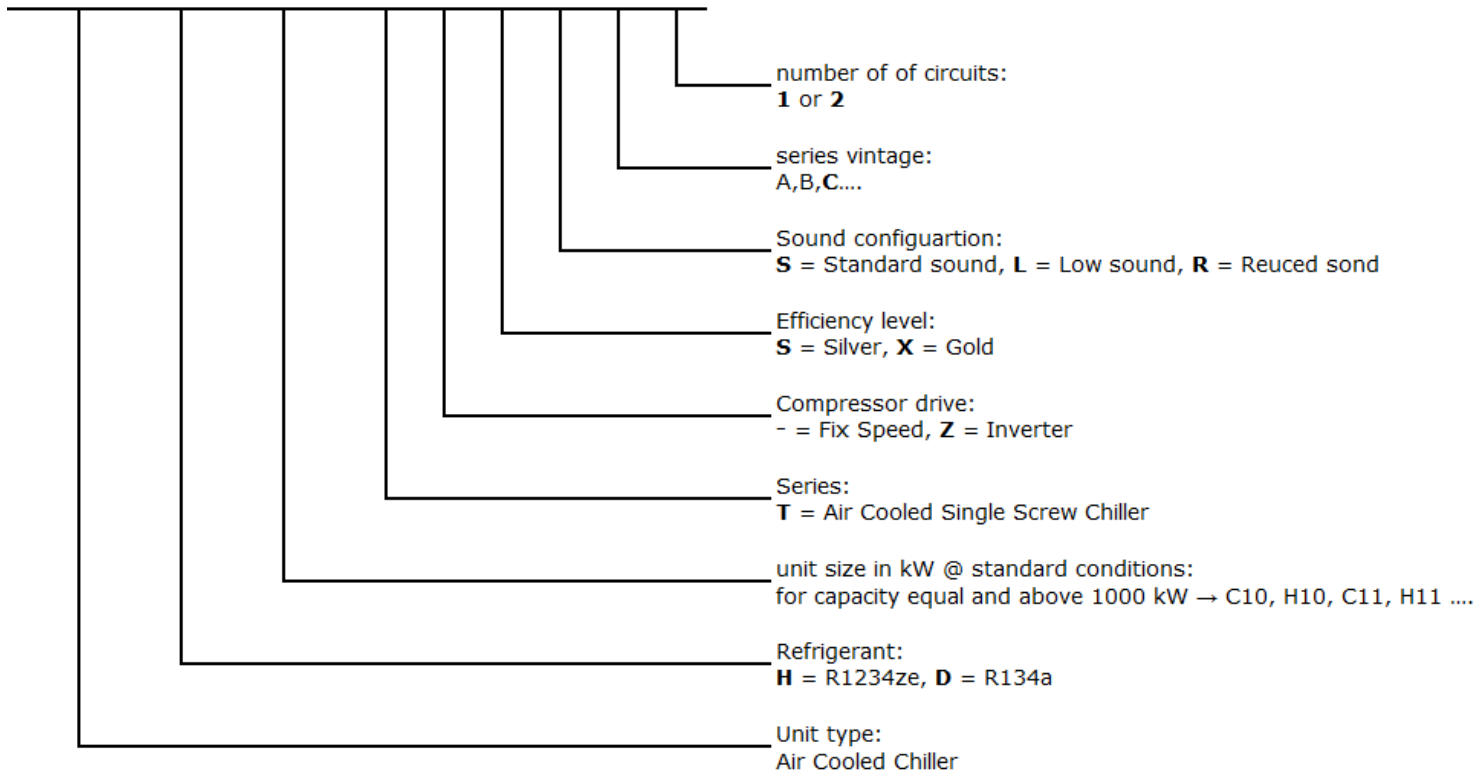

## Standard features (options supplied as standard on basic unit)

**Double set point (opt. code 10 – provided as standard)** Dual leaving water temperature set points.

**Phase monitor (opt. code 13 – provided as standard)** Device that monitors input voltage and stops the chiller in case of phase loss or wrong phase sequence.

**20mm evaporator insulation (opt. code 29 – provided as standard)** The external shell is covered with a 20mm closed cell insulation material.

**Electronic expansion valve (opt. code 60 – provided as standard)**

**Discharge line shut-off valve (opt. code 61 – provided as standard)** Installed on the discharge port of the compressor to facilitate maintenance operation.

**Set point reset, demand limit and alarm from external device (opt. code 90 – provided as standard)**  
The options can be enabled on the unit controller:

**Setpoint Reset:** The leaving water temperature set-point can be overwritten with an external 4- 20mA, through the ambient temperature, or through the evaporator water temperature  $\Delta T$ .

The active setpoint is calculated applying a correction which is a function of ambient temperature (OAT). As temperature drops below the Start Reset OAT (SROAT), LWT setpoint is gradually increased until OAT reaches the Max Reset OAT value (MROAT). Beyond this value, the LWT setpoint is increased by the Max Reset (MR) value.

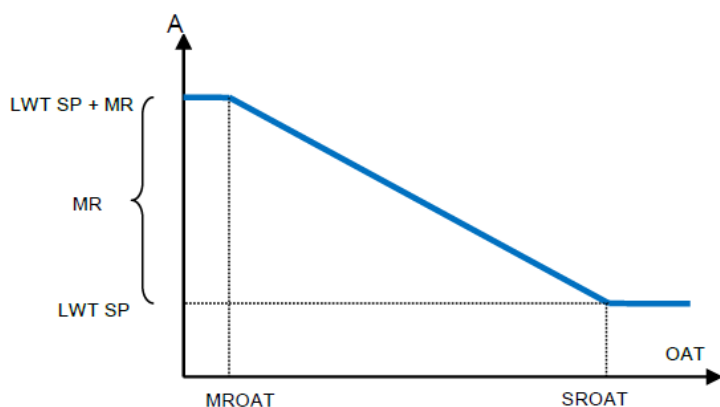

Parameter	Default	Range
Max Reset (MR)	5.0°C	0.0°C ÷ 10.0°C
Max Reset OAT (MROAT)	15.5°C	10.0°C ÷ 29.4°C
Start Reset OAT (SROAT)	23.8°C	10.0°C ÷ 29.4°C
Active Setpoint (AS)		
LWT Setpoint (LWT SP)		Cool/Ice LWT

**Demand Limit:** Chiller capacity can be limited through an external 4-20mA signal or via network. Demand limit function allows the unit to be limited to a specified maximum load. Capacity limit level is defined with an external 4-20 mA signal and linear relationship. 4 mA indicate maximum capacity available whereas 20 mA indicates minimum capacity available. With demand limit function is not possible shutdown the unit but only unload it until minimum admissible capacity. Demand limit related setpoints available through this menu are listed in the table below.

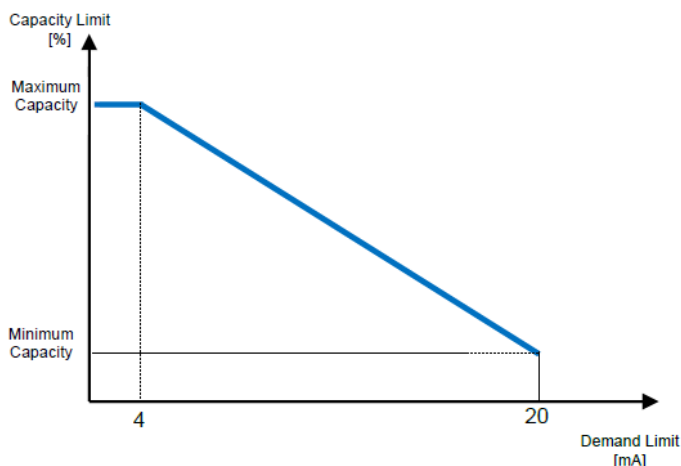

Parameter	Description
Unit Capacity	Displays current unit capacity
Demand Limit En	Enables demand limit
Demand Limit	Displays active demand limit

**Alarm from external device:** The unit controller is able to receive an external alarm signal. The user can decide whether this alarm signal will stop the unit or not.

**Evaporator electric heater (opt. code 57)** 125W electric heater, controlled by a thermostat (heater is activated if water temperature is <4°C) and installed in the evaporator.

**Hour run meter (opt. code 68 – provided as standard) General**

**Fault contactor (opt. code 69 – provided as standard)**

**Fans circuit breakers (opt. code 96 – provided as standard)** Safety devices that, added to the standard protection devices, protect fan motors against overload and overcurrent.

**Main switch interlock door (opt. code 97 – provided as standard)**

**Quiet Mode Scheduling**

The Quiet Mode can be used to reduce chiller noise in certain hours of the day when noise reduction is more important than cooling operation, like for example in night time. When Quiet Mode is activated, the LWT setpoint is increased by the maximum setpoint reset (MR) described in the chapter "Setpoint Reset", thus forcing a capacity limitation to the unit without losing control on chilled water temperature. Also, condenser temperature target is increased by a value set in "QM Cond Offset" (refer to User Manual for more details). In this way condenser fans are forced to reduce speed without losing control on condensation. Quiet mode is timer enabled.

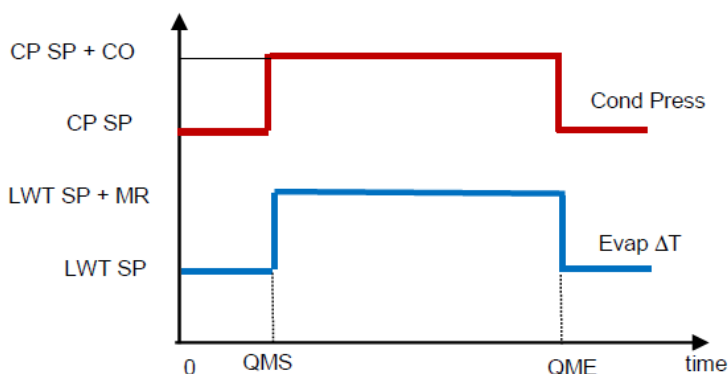

Parameter	Default	Range
Quiet Mode	Disable	Disable, Enable
QM Start Hr (QMS)	21h	0...24h
QM Start Min	0min	0...60min
QM End Hr (QME)	6h	0...24h
QM End Min	0min	0...60min
QM Cond Offset (CO)	5°C	0...10°C

NOTE: to achieve noise reduction at part load the unit must be equipped with a variable speed fans control (FANS SPEED REGULATION -INVERTER, EC motors fans, 100 PA ESP, 200 ESP fans)

**Time Scheduler**

Unit On/Off can be managed automatically through the function Time Scheduler enabled when the parameter Unit Enable is set to Scheduler 0. For each day of the week user can define six time slots and choose for each time slot if the unit must be OFF or active and for the active mode choose which of the two setpoints to follow. (refer to the User Manual for more details).

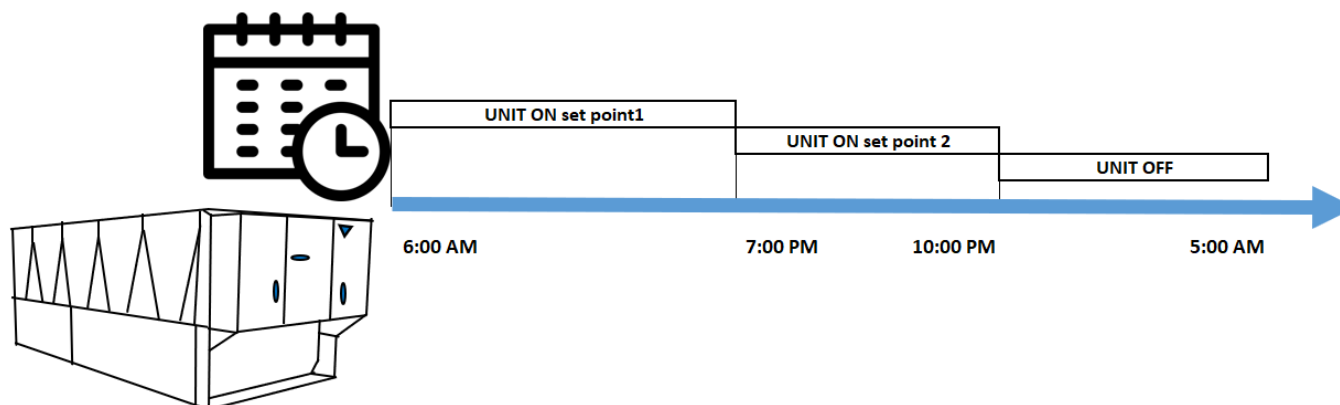

**Master / Slave (opt. code 128 – provided as standard)**

The EWA(H)(D)~TZ-C features the DAIKIN Master/ Slave (M/S) control.

This functionality allows to manage up to 4 chillers installed in parallel on the same water loop.

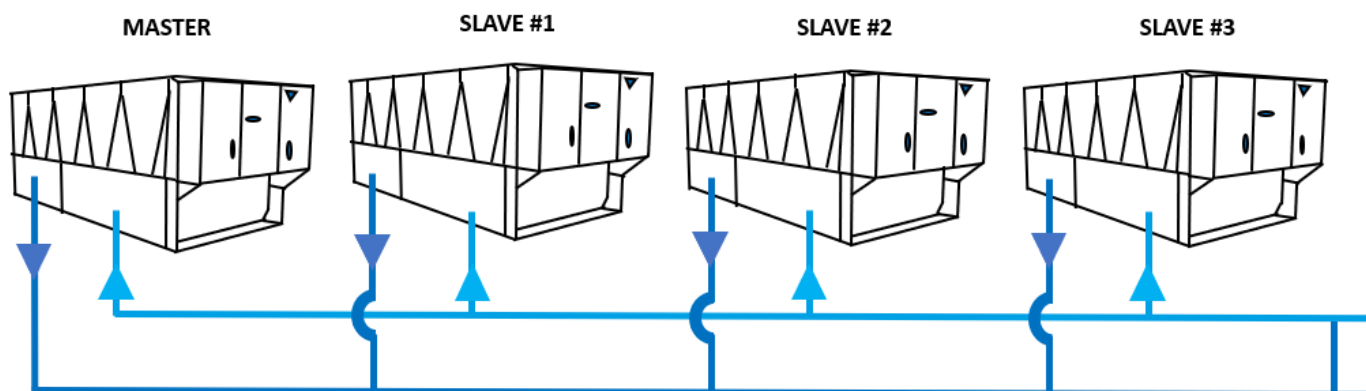

M/S can:

- Rotate the chiller operation balancing the running hour.
- Avoid simultaneous starts of the chillers installed.
- Control systems combining EWA(H)(D)~TZ (Daikin fix speed screw Air Cooled chiller) with EWAD~T- (Daikin Inverter Screw Air Cooled chiller).
- Sequence based on water set-point and time

With Master / Slave is not possible:

- to control mixed plant including TZ and Scroll chillers, or screw and scroll heat pumps or multipurpose units.
- to control multiple units' plant with variable flow logic;
- to control units with Rapid Restart functionality;
- to manage units with heat recovery option
- to manage multiple chiller system base on optimal efficiency

For all the above cases the option Intelligent Chiller Manager (iCM) Standard must be provided.

The option 143 Variable Primary Flow is not compatible with ICM Standard.

To operate with Variable Primary flow in multiple chiller Plants iCM Standard must be provided.

To operate with Variable Flow on based deltaT in multiple chiller Plants iCM Standard must be provided.

Standard chiller capacity control is based on the evaporating leaving water temperature. To keep the same control in case of units connected in M/S an additional temperature sensor must be installed on the common line of the hydraulic circuit and connected to the Master unit. The temperature sensor can be an NTC10K or PT1000. The temperature sensor is not provided by the factory).

In case no additional probe is installed is possible to activate the control based on the entering water temperature.

Once set which unit has the role of master, the other(s) will operate as slave(s) based on the inputs provided by the master.

Options on request

**Total Heat Recovery (opt. code 01)** A plate to plate heat exchanger for each refrigerant circuit is installed directly in series to the air condenser coil, thus, compressor discharged refrigerant is always flowing through the heat recovery exchanger and warm water production is always available while the chiller is providing cooling.

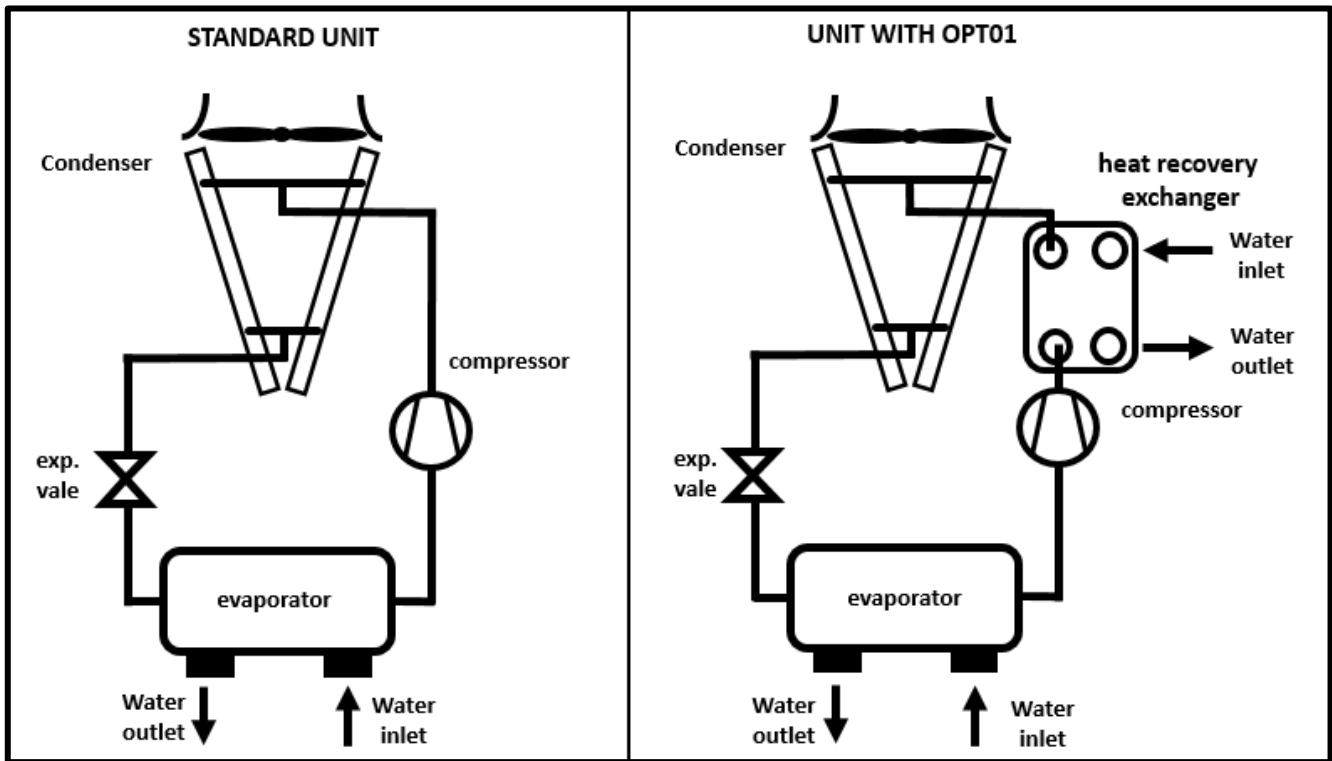

A plate to plate heat exchanger for each refrigerant circuit is installed in series to the air condenser coil. There is no switch nor solenoid valve in the circuit, thus compressor discharged refrigerant is always flowing through the heat recovery exchanger and warm water production is always available while the chiller is providing cooling. The amount of heat recovered is about the 80/85% of the total heat rejection of the chiller (the actual amount of the available heat rejection recovered depends on the operating conditions). When heating capacity is required the unit's controller starts to manage the condensing pressure, according to the required set point for the hot water, acting on the airflow for the condensing section. The heating available for heat recovery is a result of the cooling operation. No heating is available when cooling is not requested.

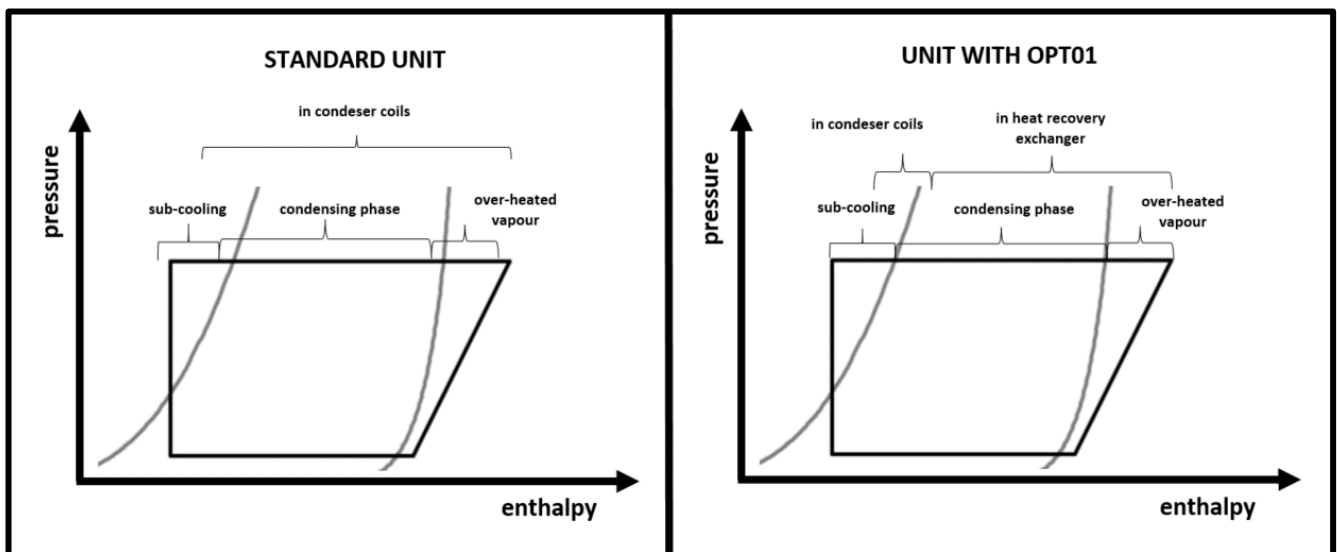

The Total heat recovery function operate according the following scheme:

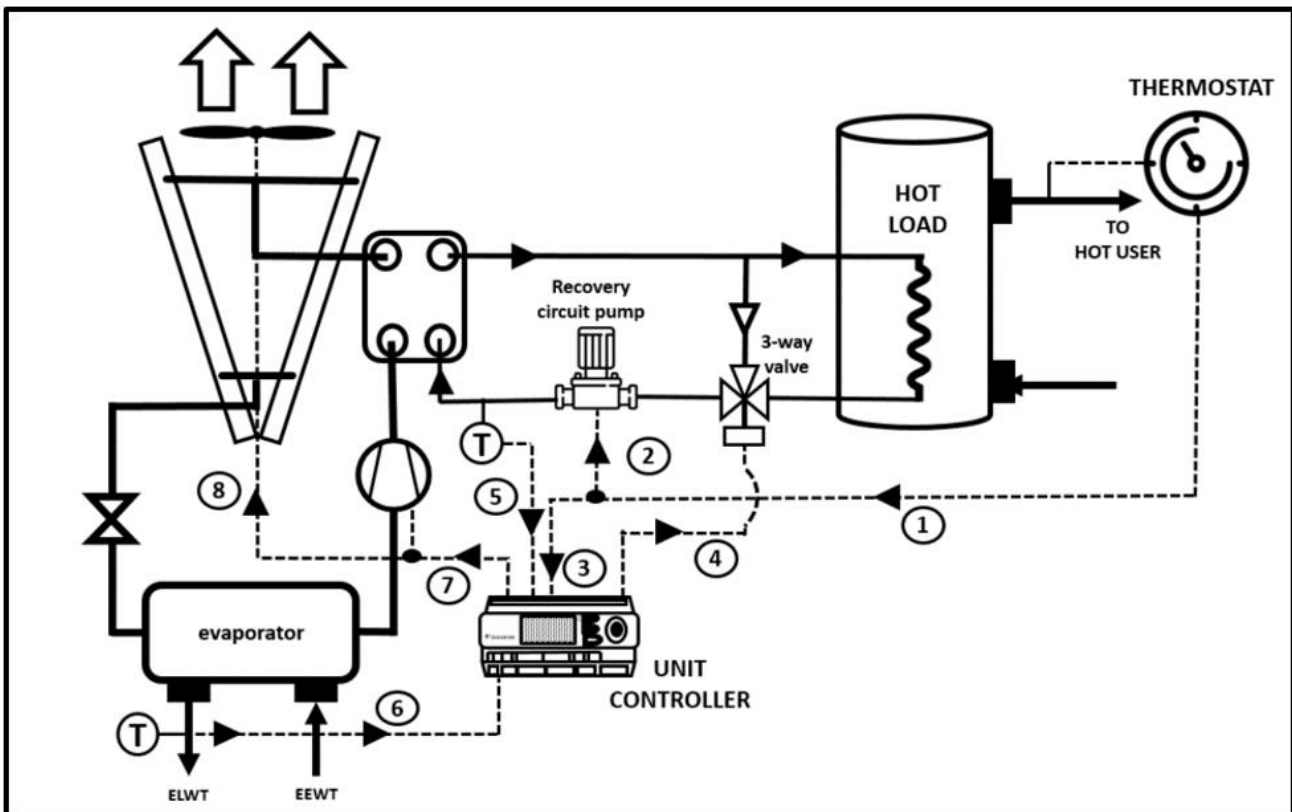

The thermostat (filed supply) detects when heating energy is required from the user. Once the water temperature to the HOT USER goes below the set-point, a signal (1) is sent to activate the heat recovery pump (2) and to the unit controller (3) enabling the HEAT RECOVERY MODE. The unit controller modulates the valve according the to the temperature entering the heat recovery exchanger. The valve must be positioned as mixing valve. Once the controller switch to HEAT RECOVERY MODE it starts to compare the inlet temperature to the plate heat exchanger with the set-point given to the unit controller; if the temperature goes below that setpoint unit starts to manage the entering water temperature (8). The capacity of the unit is anyway managed by the controller (7) based on the outlet temperature from the evaporator (6). The heating capacity is a percentage of the whole heat rejection resulting from the chiller operation and is available only when cooling capacity is requested at the same time.

The mixing valve must be installed to avoid cold water entering the heat recovery exchanger. The valve (not provided by the factory) must a be a continuously modulated type. The signal for the modulation is provided by the chiller (4) (0-10V signal). The modulation of the valve is based on the entering water temperature to the heat recovery exchanger.

When heat recovery is ON the unit efficiency to consider is not the EER (Energy Efficiency Ratio) which refers only to the cooling effect of the unit. With heat recovery the unit is also providing heating energy that otherwise should still be provided by another source.

The Total Efficiency Ratio is defined as:

$$TER = \frac{\text{Cooling capacity} + \text{Heating capacity}}{\text{power input}}$$

**Total Heat Recovery (THR)** option affects the cooling performances of the unit according the ambient temperature and the hot water temperature requested. Check for the unit performances in the Chiller Selection Software.

**Partial Heat Recovery (opt. code 03 – NOT AVAILABLE FOR EWAH~TZ-C units)**

A plate to plate heat exchanger for each refrigerant circuit is installed in series to the air condenser coil. There is no switch nor solenoid valve in the circuit, thus compressor discharged refrigerant is always flowing through the heat recovery exchanger and warm water production is always available while the chiller is providing cooling. The unit layout is similar to the one with OPT01; the plate heat exchanger placed at the compressor discharge is smaller compare to the one used for total heat recovery and the heating capacity available is only the one related to the over-heated vapor.

The amount of heat recovered is about the 15/20% (according to the operating conditions) of the total heat rejection of the chiller. Heat recovery capability is subject to cooling load demand (if no cooling demand is present then no heat recovery is available) and strongly affected by the ambient temperature and requested hot water temperature. Differently from option Total Heat Recovery, the unit controller does not manage the condensing temperature in partial heat recover operation. The heat recovery operation must be managed from the plant manager that controls the pump on the recovery circuit. Also, when Partial Heat Recovery is ON the efficiency of the chiller is represented by TER and not simply by EER.

**Brine Version (opt. code 08)** For operation with temperature at the outlet of the evaporator below 4°C, the unit must operate with glycol mixture (with ethylene or propylene glycol) and the Brine Version option must be selected. The option provides dedicated control function, optimized evaporator and additional insulation on heat exchanger and piping.

**Compressor suction insulation (opt. code 176)** to improve aesthetics avoiding moisture on compressor’s suction (coldest part).

**Evaporator Victaulic KIT (opt. code 20)** Victaulic kit includes the Victaulic joint and the counter pipe fitted with Victaulic groove to be welded with the plant pipes.

**Evaporator flange KIT (opt. code 21)** The flange kit includes flange, counter-flange and gaskets, bolted together with fasteners and nuts.

**Suction line shut-off valve (opt. code 62)** Installed on the suction port of the compressor to facilitate maintenance operation.

**High pressure side manometers (opt. code 63)**

**Low pressure side manometers (opt. code 64)**

**Double pressure relief valve with diverter (opt. code 91)**

**SOUND PROOF SYSTEM (COMPRESSOR) (opt. code 76b)** Selecting this option the unit is provided with compressors enclosure for enhanced protection of the compressors, acoustic attenuation and improve aesthetics of the unit. In addition to the compressor enclosure, a flexible joint is inserted on compressor suction line significantly reduces the transmission of the vibration from the compressor to the chiller structure.

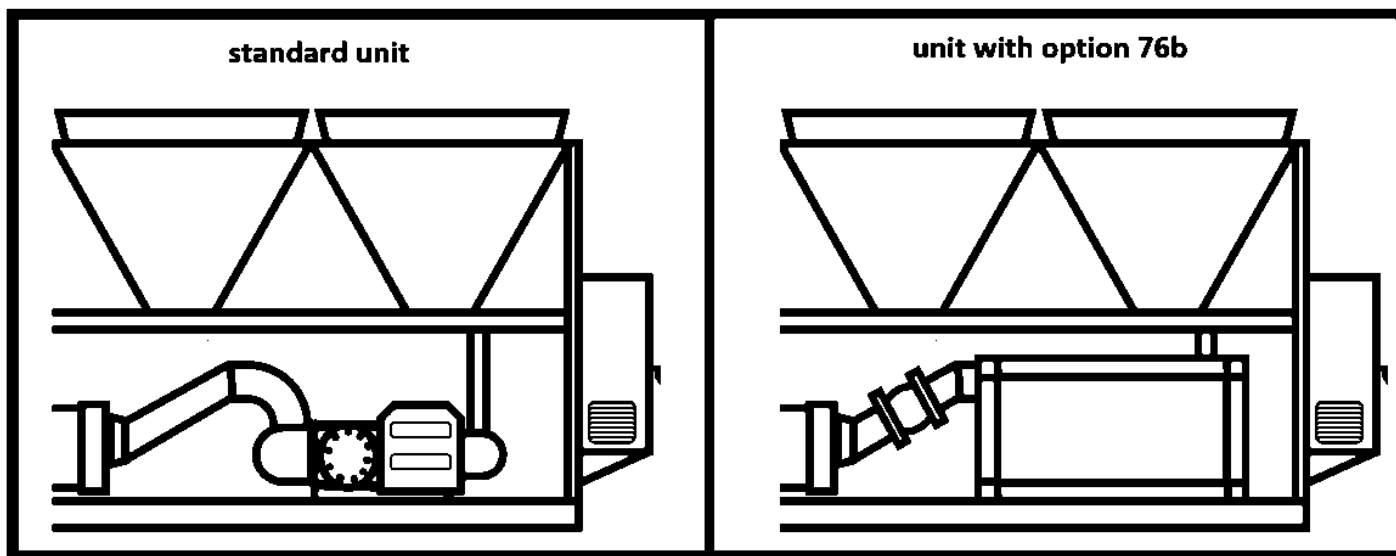

For information on sound performances for the unit with option 76b refer to Specification table or to Chiller Selection Software



**E-coating microchannel coils (opt. code 139)** As protection, a layer of an epoxy polymer is added on the surface of the exchanger. The process consists in the complete immersion of the exchanger in the epoxy polymer solution. An electric voltage applied to the exchanger causes a difference with the electrical charge of the polymer molecules that, as result, are drawn to the metal. The thickness of the coating is controlled by the applied voltage. The result is a uniform layer of epoxy polymers applied all over the exchanger surface. A final UV topcoat treatment is applied on the coil surf

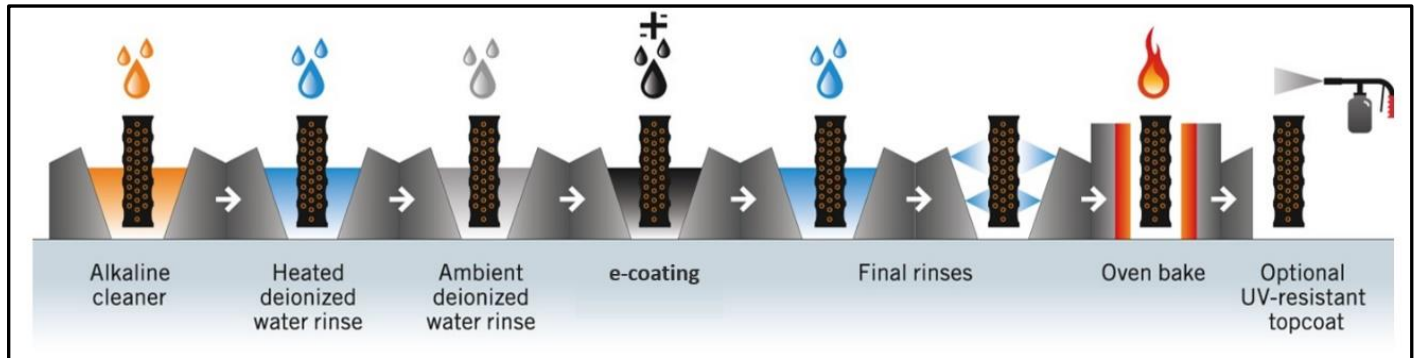

The treatment is recommended in all application where high risk of corrosion exist (e.g.: high polluted urban, costal, industrial environments and their combinations).

In the table below, technical properties of the treatment are described:

PROPERTY	TEST METHOD	PERFORMANCE
Salt Spray Corrosion	ASTM B117 / DIN 53167	6,000+ hours
SWAAT Corrosion	ASTM G85-A3	2,500 hours
Cross Hatch Adhesion	ASTM D3359	4B-5B
Pencil Hardness	ASTM D3363	2H minimum
Dry Film Thickness	ASTM D7091	0.6-1.2 mils / 15-30 µm
Direct Impact	ASTM D2794	160 in-lb
Water Immersion	ASTM D870	1,000 hours
Humidity	ASTM D2247-99	1,000 hours minimum
Heat Transfer Reduction	--	less than 1%
Bridging	--	No bridging including enhanced & micro-channel fin designs
Coating of Enhanced fins	--	Up to 30 fins per inch
pH Range	--	3-12
Temperature Limits	--	-40°F to 325°F / -40°C to 163°C (dry load)
Gloss - 60 Degree	ASTM D523	55-75

**Blue coat (opt. code 153)**

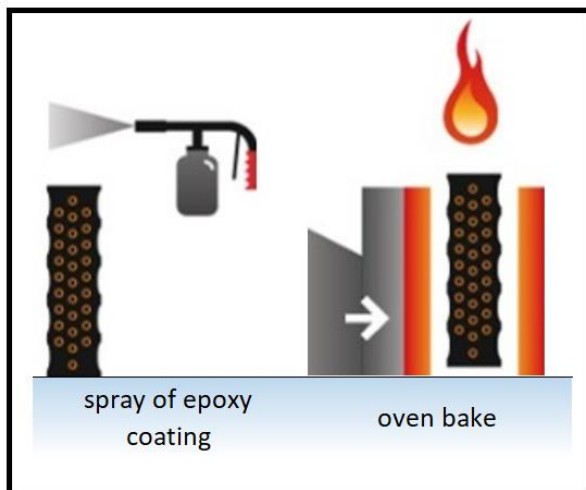

An epoxy powder is sprayed and electrostatically fixed to the coil. Once the external surface is completely covered by the epoxy material, the coil is sent in to a furnace for the drying and curing phase. The result is a uniform and durable coating on the external surface of the coil that enhance the resistance to the corrosion.

The treatment is recommended in all application where moderate risk of corrosion exist (e.g.: light polluted urban and industrial environments).

The color of the condenser with blue coat is light blue.

NOTE: for installations in industrial environment the resistance to specific pollutant of the specific type of coil should be verified.

**Unit guards (to cover unit access) (opt. code 140)** Wire mesh that covers the access all around the unit

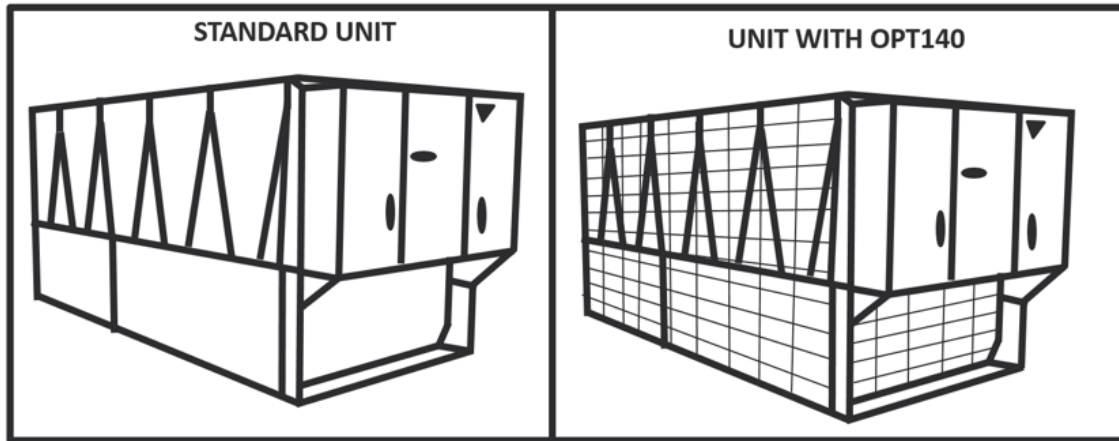

**Side panels on coil ends (opt. code 141)** Protection carter on both side of each condensing module.

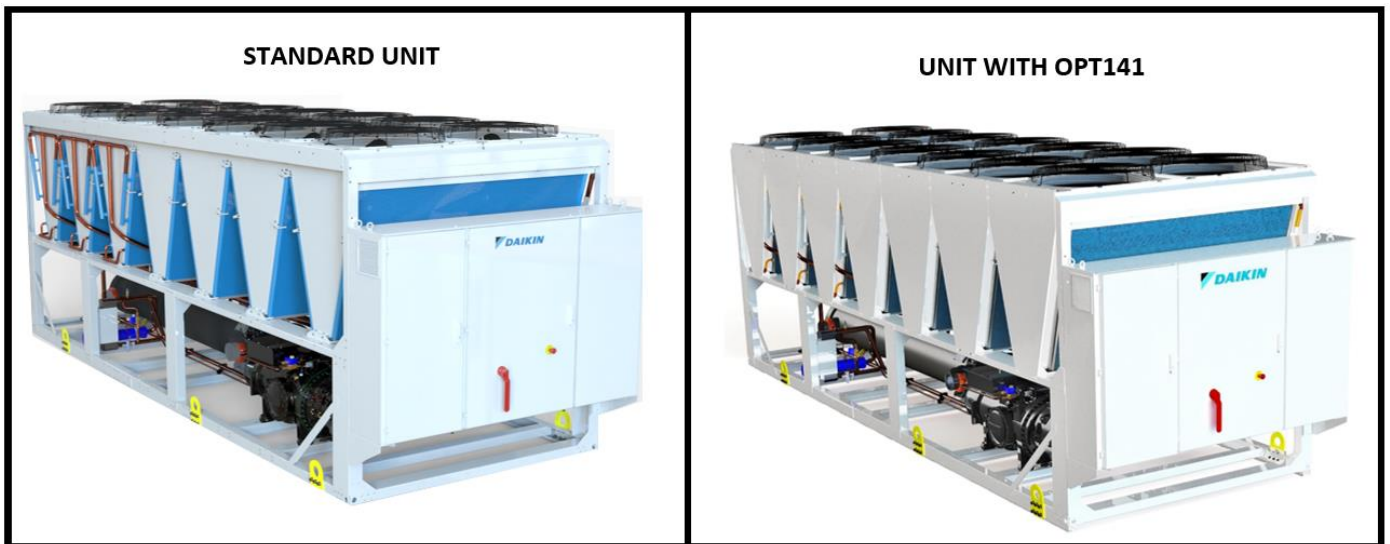

**Unit right water connection (opt. code 101)** Provides water connection on the right side.

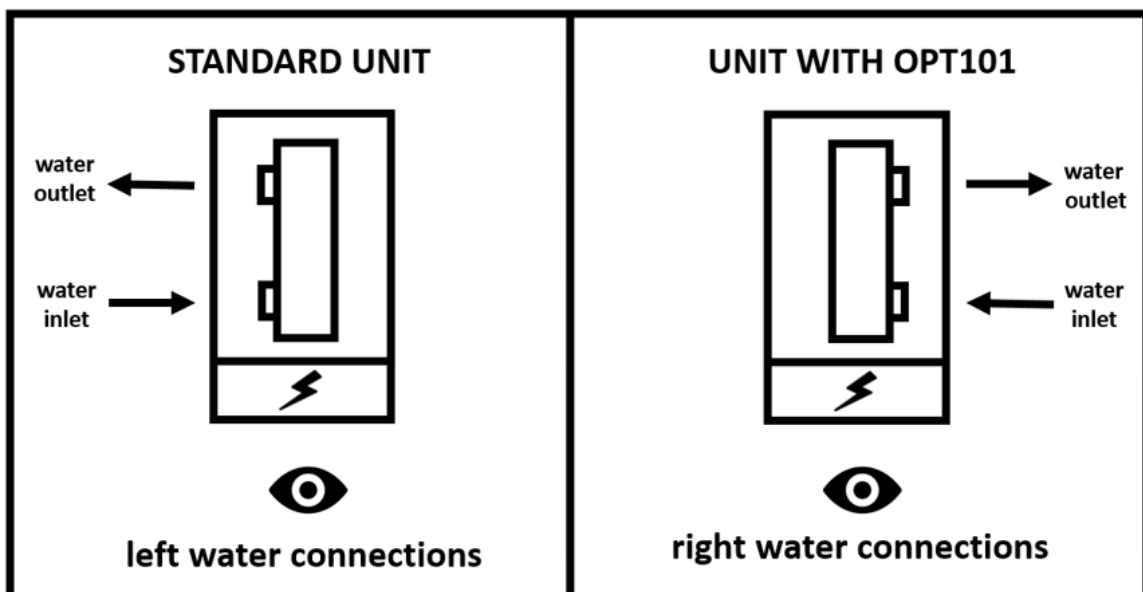

**Water filter - Victaulic connections (opt. code 115)** to prevent damages to the water heat exchanger due to the presence of particles in the water a filter must be installed.

With option 153 a water filter is shipped loose with the unit. Is customer responsibility to properly install and maintain the water filter.

To be effective the filter must be installed at the entering of the unit;

DO NOT REVERSE the water inlet and outlet of the filter (see Installation notes for more details).

The inside taper filter cartridge is made of stainless steel 304, thickness 1.5 mm, holes diameter 5.5 mm, distance between two holes 6.5mm, are per centum 64,4%.

Filter screen is made of 304, max passage 0.5 mm.

NOTE: the installation of the filter is mandatory either if supplied by DAIKIN or from third part supplier.

Proper filter cleaning and maintenance is key to ensure chiller operation.

The pressure drop across the water filter provided by DAIKIN are given by the following formula:

$$\text{Pressure drop} = a * (\text{water flow in m}^3/\text{h})^b$$

Connection diameter [mm]	a	b
114	0.00417	1.954
140	0.00128	2.002
168	0.00065	1.928
219	0.00026	2.011
273	0.00009	1.974

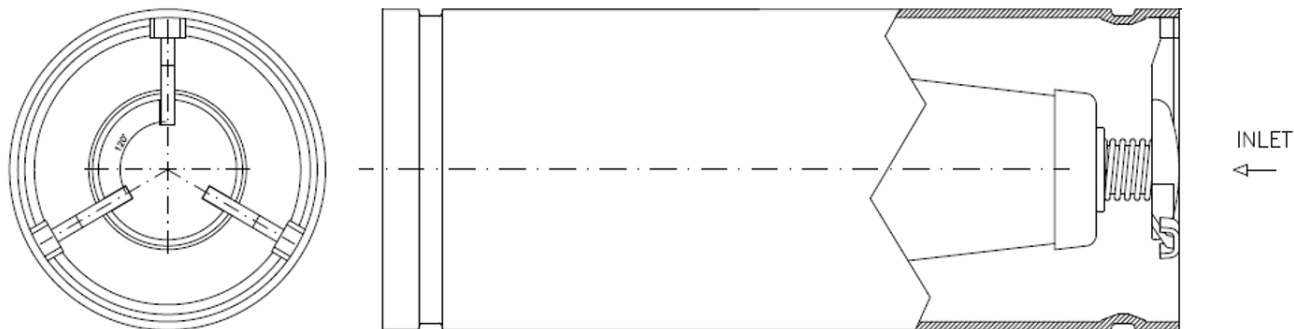

**Evaporator flow switch (opt. code 58)** Paddle type. Supplied separately to be wired and installed on the evaporator water piping (by the customer). The installation of the flow switch is mandatory.

**Hydronic kits (opt. codes 78, 79,80, 81)**

Is possible to equip the unit with a hydronic kit. There are 4 possible configurations:

- **One centrifugal pump (Low lift) (opt. code 78)**
- **One centrifugal pump (High lift) (opt. code 79)**
- **Two centrifugal pumps (Low lift) (opt. code 80)**
- **Two centrifugal pumps (High lift) (opt. code 81)**

The kit is completed with pressure gauge, safety valve, drain valve. The motor pump is protected by a circuit breaker installed in control panel. The kit is assembled and wired to the control panel. The pipe and pump are protected from freezing with an additional electrical heater.

Low lift version provides an average available head of about 100÷150 kPa or more at chiller standard conditions. High lift version provides an average available head of about 200÷250 kPa or more at unit standard conditions. Please refer to the relative graphs in the " Options (Technical data)" chapter.

Note: In case of unit equipped with hydronic kit on board selected to operate with over 30% of propylene glycol mixture contact factory.

**Inverter kit for pumps**

is possible to add an inverter kit to each hydronic kit.

- **Inverter kit for 1 centrifugal pump Low lift (opt. code 120e)**
- **Inverter kit for 1 centrifugal pump High lift (opt. code 120f)**
- **Inverter kit for 2 centrifugal pumps Low lift (opt. code 120g)**
- **Inverter kit for 2 centrifugal pumps High lift (opt. code 120h)**

Note: The Inverter kit must be associated with the corresponding hydronic kit (opt. code 78/79/80/81).

The inverter kit can be used for the following purposes:

- **Tuning the water flow during unit commissioning**

The inverter for the pumps can be used to tune the water flow rate during the commissioning. Once the speed of the pump and so the water flow rate is defined the pumps will run constantly at that speed.

- **Control the pump speed via external input from Building Management System (BMS)**

For this application, a 0-10V signal to control the pump speed must be provided from the plant manager according to the specific control strategy of the plant. The water must be within the minimum and maximum value allowed for the unit (refer to the Technical specifications and to the "Operating limit" chapter). The change in water flow rate must not be exceed more than 10% of the design water flow rate per minute.

- **Set a "thermostat off" pump speed**

Providing the unit with the inverter kit for the on-board pump it is possible to manage two different water flow rate settings. A setting for water flow during the "Thermostat ON" mode (when the unit is now providing cooling to the plant) and a set for the "thermostat OFF" mode (when the plant load is satisfied, and the compressors are waiting to start). This feature allows to achieve energy saving on plant operating cost by reducing the speed of the pumps when the unit has reached the set point.

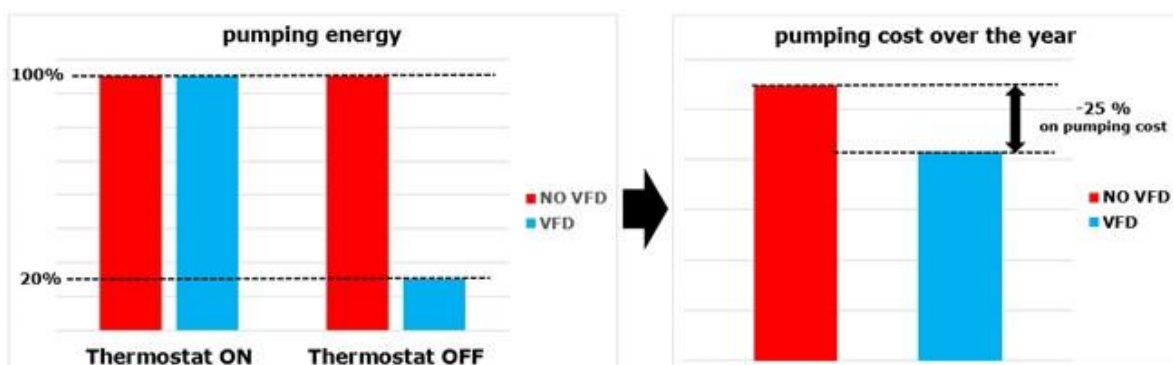

Thanks to the saving on pumping cost, the payback time for the Inverter Kit is approximately one year.

- **Control variable flow on primary loop based on chiller delta-T** (available as standard for single chiller installation only)  
 Providing the unit with the inverter kit for the on-board pump it is possible to manage a variable water flow rate for the primary loop. This function is available as standard when the hydronic kit plus inverter are selected. The standard feature is applicable for single unit installation only. In case of multiple chillers installation an additional control is needed.  
 The variable flow control is suitable for primary/secondary plant, cannot be used in primary plant only.

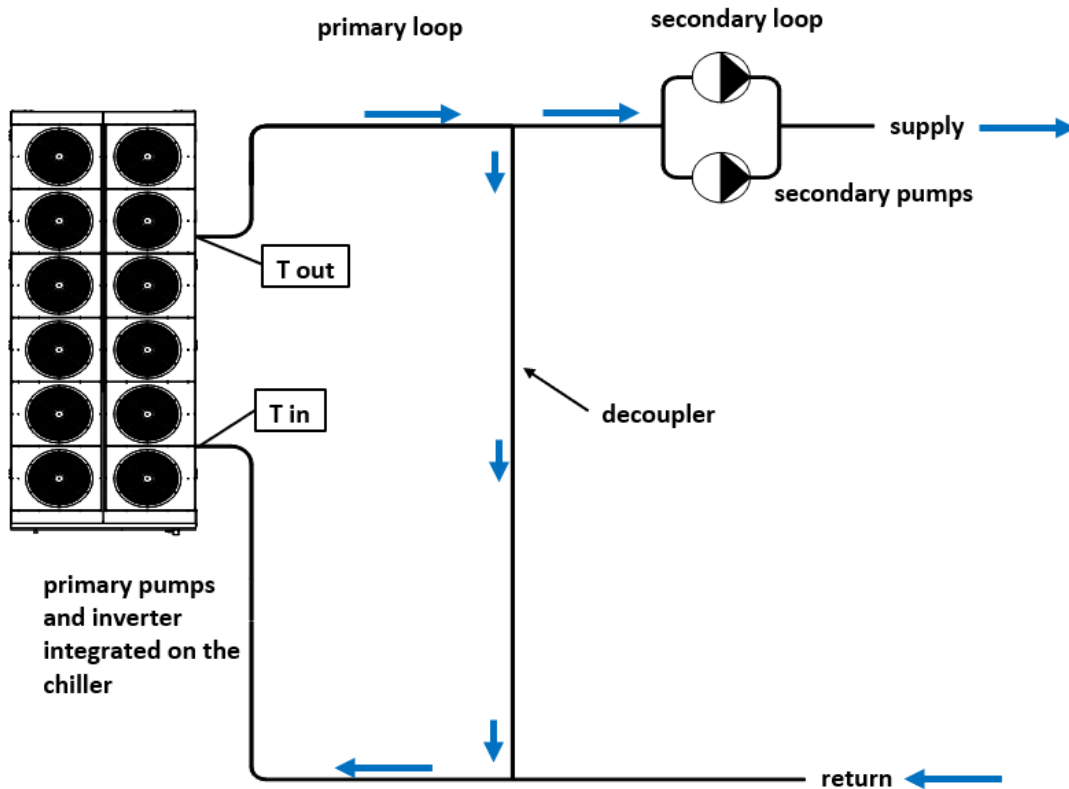

In a Primary-Secondary plant configuration a key component is the decoupler. The decoupler is always open (no valve must be installed). The aim of the decoupler is to allow the primary and secondary pumps to operate at different flow rates. This is necessary because the primary pumps and secondary pumps are managed differently and so the primary and secondary flow rate are practically never the same. Specifically, the primary flow rate is managed based on the chiller delta-T ( $T_{out} - T_{in}$ ) the secondary flow rate is regulated to maintain the necessary pressure differential in the secondary loop. The direction of the water flow through the decoupler must be always from supply to return. To ensure this the primary flow rate must be greater than the secondary flow rate. If this condition is not respected the warmer return water will flow backwards through the decoupler and raise the supply water temperature. Due to the higher temperature of the supply water temperature the terminal unit control will open the valves asking for higher water flow rate. The secondary pumps will speed up increasing even more the water flow rate on secondary plant making the situation even worse (secondary flow rate  $\gg$  primary flow rate). As a result there will be no control on the supply water temperature losing effectiveness of the cooling plant.

On the other side any excess in the primary flow, vs. secondary flow, flows through the decoupler from the supply to the return mixing with the warmer return water. To reach this target is very important to have minimum pressure drop in the decoupler that needs to be sized to reach a pressure drop that should not exceed 4-5 kPa at the minimum for the flow rate of the primary pump.

Activating the variable flow control the chiller will modulate the water flow rate based on the chiller delta.

When the secondary loop will reduce the water flow rate (because the plant load decrease), the water flow rate in the decoupler (always from supply to return) increases. The return water temperature mixes with the supply water from the decoupler reducing the water temperature the inlet temperature and so the delta-T on the chiller. As a consequence the chiller control reduces the speed of the pump, reducing the primary flow rate.

On the opposite, when the flow rate on secondary flow increases also the water temperature at the chiller inlet increases (increasing the delta-T); therefore, the chiller control will increase the water flow rate.

**Variable Primary Flow (opt. code 143)**

The Variable Primary Flow (VPF) configuration is an alternative to the more “traditional” Primary/Secondary (P/S) plant configuration.

An installation must follow all the design criteria for such systems to be defined as Variable Primary Flow.

For this reason, the option 143 should be ordered only if the customer asks for unit capable to manage the speed of the pump in a system designed to operate according to the Variable Primary Flow configuration and not as a general answer to “variable pump speed”.

By selecting opt. 143, the TZ can manage the variable primary water flow according to the differential pressure measured in a specific point of the plant, selected by the plant designer.

Daikin Applied Europe is not responsible for the plant configuration and cannot confirm the optimal position of the differential pressure transducer.

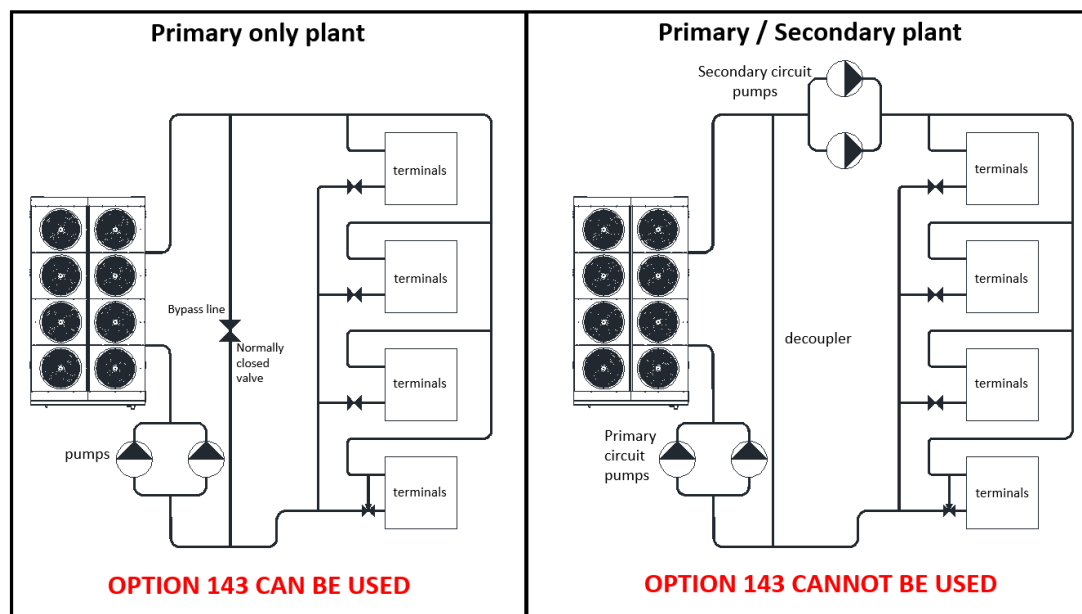

For unit installed in Primary/Secondary plants the option Variable Primary Flow is not applicable. In this case a different a different control is required.

For different kind of water flow management iCM must be provided.

To operate in Primary/Secondary plants with variable flow in primary loop the iCM must be provided.

The option 143 can be selected only together with the other hydronic kit option (see the table below).

	Fixed speed	Variable speed pump (for “thermostat off” pump speed function or to be controlled with external BMS)	Variable Primary Flow management
ONE CENTRIFUGAL PUMP (LOW LIFT)	Opt 78	Opt 78 + Opt 120e	Opt 78 + Opt 120e + Opt 143
ONE CENTRIFUGAL PUMP (HIGH LIFT)	Opt 79	Opt 79 + Opt 120f	Opt 79 + Opt 120f + Opt 143
TWO CENTRIFUGAL PUMP (LOW LIFT)	Opt 80	Opt 80 + Opt 120g	Opt 80 + Opt 120g + Opt 143
TWO CENTRIFUGAL PUMP (HIGH LIFT)	Opt 81	Opt 81 + Opt 120h	Opt. 81 + Opt 120h + Opt 143

Note: the option 143 Variable Primary Flow (VPF) is intended for a single unit installation. In case of multiple units’ system in VPF plant iCM must be provided.

A bypass line (field supply) needs to be installed to guarantee that the minimum water flow of the unit is always supplied (refer to the “Operating limit” chapter for indication on minimum water flow). The bypass valve will be an ON/OFF normally closed valve controlled by the unit controller. In case the minimum water flow allowed is not reached, the unit will command the valve to open the bypass line restoring the water flow above the minimum value.

The option 143 includes:

- dedicated control logic;
- differential pressure transducers on cold and hot side installed and wired on the unit.

The unit with option 143 cannot manage external variable speed pumps. For such control iCM must be provided



**Compressors circuit breakers (opt. code 95)** A safety device which ensures thermal and electrical protection against motor overcurrent (overtemperature) and overload protection. Overcurrent protection is protection against excessive currents or current beyond the acceptable current rating of equipment. It operates instantly when the current exceeds the overcurrent imposed the overcurrent threshold. Short circuit is a type of overcurrent. The breaker acts practically instantly when the current reaches the threshold value, while the thermal relay reacts with a timing related to the percentage of over-load.

**Energy meter (including current limit) (opt. code 16a)** Device installed inside the control box that displays all chiller electrical power parameters at line input such as line voltage and phase current, input active and reactive power, active and reactive energy, including current limit option. An integrated RS485 module allows a Modbus communication to an external BMS.

Current limit function allows to control unit power consumption taking current drawn below a specific limit. Starting from the Current Limit Setpoint defined through the HMI or BAS communication, user can decrease the real limit using an external 4-20mA signal as indicate in the graph below. With 20 mA real current limit is set to Current Limit Setpoint, whereas with 4 mA signal the unit is unloaded until minimum capacity.

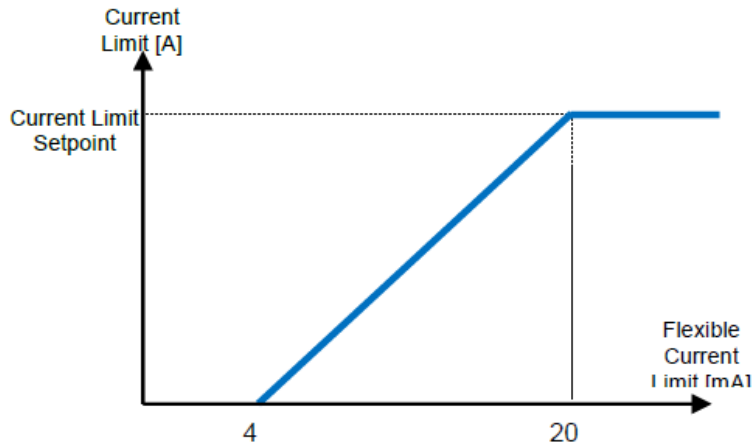

**Ground fault relay (opt. code 102)** To shut down the entire unit if a ground fault condition is detected.

**Rapid restart (opt. code 110)** Rapid Restart is the ideal solution for those application where we cannot afford the loose of cooling such as data centers, health care facilities, process cooling ...etc. For this kind of applications, in case of a power failure, chiller equipment is required to restore the cooling supply to the system as fast as possible. Standard unit (without the Rapid Restart option) will be starting within 310 seconds after the power is restored and it will be reaching full load cooling capacity within 20 ÷ 25 minutes (obviously depending on the load demand). Rapid Restart is allowing the chiller to start as fast as 30 seconds after power is restored and to reach full load cooling capacity in less than 6 minutes from the unit restart.

For more details about this option please refer to the Control Manual.

With Rapid Restart option the unit controller is always powered by UPS unit and dedicated control logic allows to achieve the full load capacity in short time.

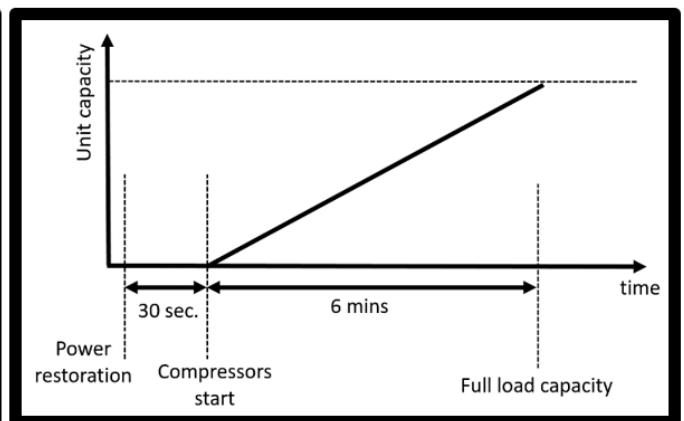
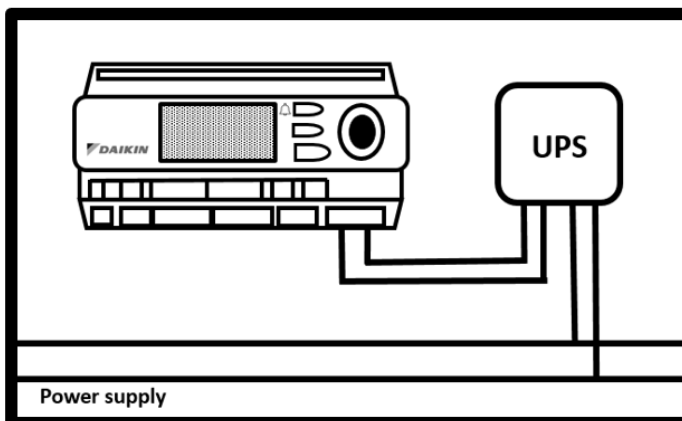

**ModBus RTU MST (opt. code 180)** The option enables the communication protocol Modbus RTU Master

**BACnet RSTP (opt. code 181)** The option enables the communication protocol BACnet RSTP

**BACnet IP (opt. code 181)** The option enables the communication protocol BACnet IP

**High ambient kit (opt. code 142)** The high ambient kit must be selected in case of installations where design condition is at 46°C ambient temperature and above.

Since mechanical switches are derated based on their load and the operational temperature, in case of operation at high ambient temperature, the unit is provided with oversized electrical equipment (e.g. main switch, fuses, cables) with the aim to increase reliability and components operating life. In addition to oversized electrical equipment other measures are taken to maximize the reliability and operating life of the components in the electrical box, such as: enhanced ventilation (depending on the model), and sunshields.

NOTE: option 142 is not compatible with option 99a

**Speedtrol (opt. code 42)**

Selecting the option 42 each circuit is equipped with one variable speed fan (driven by VFD) while the others remain ON-OFF. With this option is possible to achieve a more precise control on the refrigerant pressure inside the condenser allowing the unit to run at ambient temperature below 10°C down to -18°C.

NOTE: the Speedtrol functionality is included with opt. 99a (fans speed regulation), opt. 158, 159 EC motors fans and with opt 100 ESP fans and 200 ESP fans.

**Fans speed regulation (INVERTER) (opt. code 99a)**

Selecting the option 99a all the AC fans are controlled by VFD. The continuous modulation of the fan's speed lead to higher part load efficiency, thanks to the accurate condenser's air flow modulation, and lower noise level at part load. The unit equipped with opt. 99a can run down to -18°C ambient.

**EC motors fans (opt. code 158,159)**

with this option the standard AC fans are replaced with "brushless" (EC) type fans and with synchronous motors excited by permanent magnets and with phase currents controlled by a PWM inverter integrated in the fan motor housing, that allows operation at different speeds. This EC fans are 800 mm diameter and run up to 700 or 900 RPM according to the model size and version selected. The resulting benefit is higher efficiency at part load thanks to continuous modulation of the fans speed according the ambient temperature and the chiller load. The EC fans IP55. The unit equipped with opt. 158 or 159 can run down to -18°C ambient.

**100 Pa ESP fans (opt. code 160)**

EWA(H)(D) ~TZC chillers are designer for outdoor installation and without ducts on condenser suctions and discharge. So, all data for standard units are referred to the operation with free condenser suction and discharge and in compliance with the installation prescription. Additional pressure resistance on condenser suction or discharge will result in lower air-flow rate through the condenser heat exchanger affecting the chiller performance. Since adding external pressure resistance to the air-flow result in derating of chiller performance's (decrease of cooling capacity and increase of power input) standard chillers do not have External Static Pressure (ESP).

There are installations which requires to duct the exhaust fans or place the chiller behind louvred walls. To ensure the designed air-flow rate even with additional pressure resistance powerful fans must be installed. In case the external static pressure to win is  $\leq 100$  Pa (referred to the unit air-flow rate as indicated in technical specification) the option 160 must be selected.

Thanks to the powerful fan the design air-flow rate on ensured and so there is no derating in cooling capacity, so the chiller is provided with additional static pressure. The power input for the fans, the efficiency and the sound performances are affected. Refer to Chiller Selection Software for details on the unit performances. The unit equipped with opt. 160 can run down to -18°C ambient.



**200 Pa ESP fans (opt. code 161)**

EWA(H)(D) ~TZC chillers are designed for outdoor installation and without ducts on condenser suction and discharge. So, all data for standard units are referred to the operation with free condenser suction and discharge and in compliance with the installation prescription. Additional pressure resistance on condenser suction or discharge will result in lower air-flow rate through the condenser heat exchanger affecting the chiller performance. Since adding external pressure resistance to the air-flow result in derating of chiller performance's (decrease of cooling capacity and increase of power input) standard chillers do not have External Static Pressure (ESP).

There are installations which requires to duct the exhaust fans or place the chiller behind louvred walls. To ensure the designed air-flow rate even with additional pressure resistance powerful fans must be installed. In case the external static pressure to win is  $\leq 200$  Pa (referred to the unit air-flow rate as indicated in technical specification) the option 160 must be selected.

Thanks to the powerful fan the design air-flow rate on ensured and so there is no derating in cooling capacity, so the chiller is provided with additional static pressure. The power input for the fans, the efficiency and the sound performances are affected. Refer to Chiller Selection Software for details on the unit performances. The unit equipped with opt. 161 can run down to  $-18^{\circ}\text{C}$  ambient.

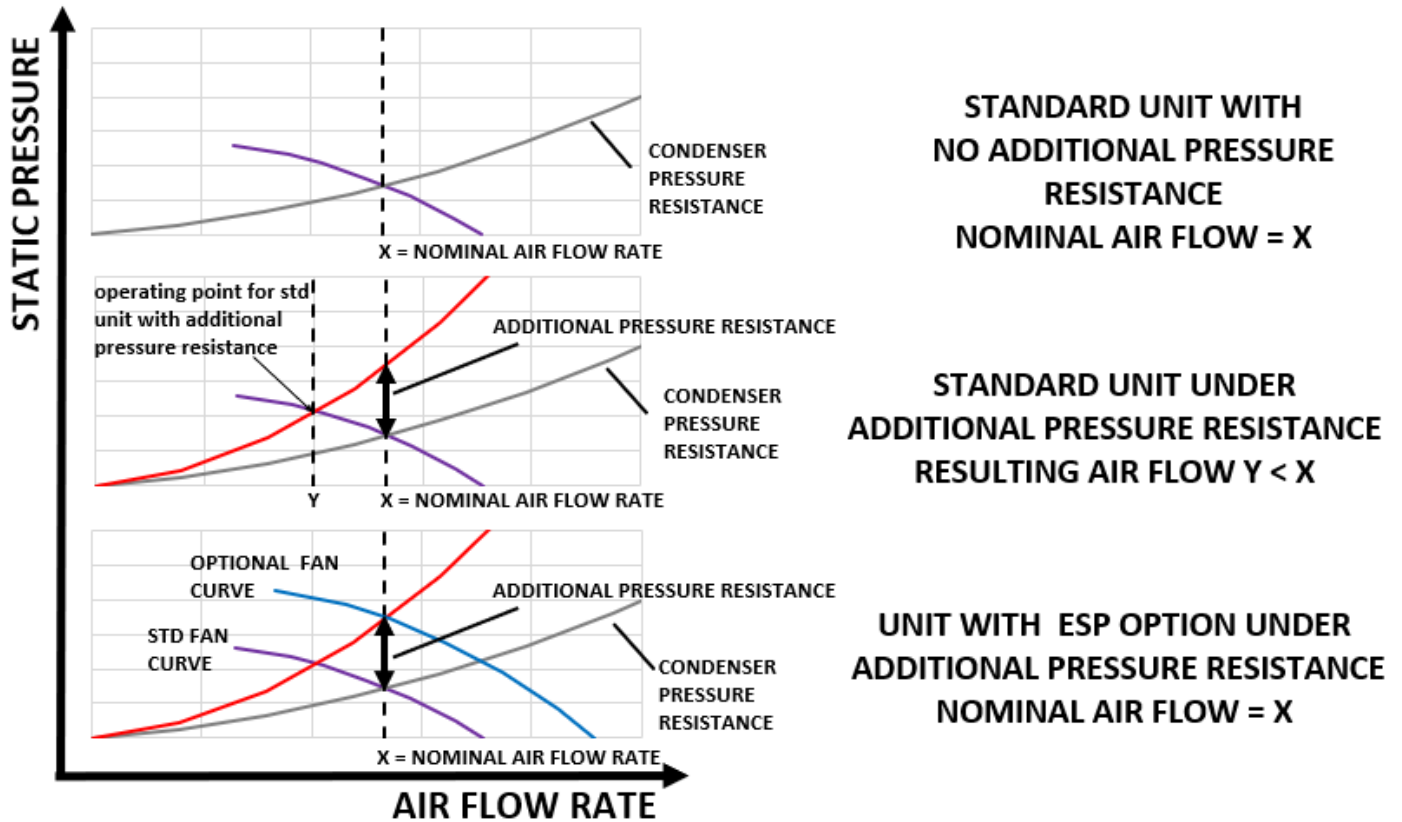

**HIGH EVAPORATOR LEAVING TEMPERATURE (ABOVE 18°C) (opt. code 187)**

With this option is possible to extend the operating envelope of TZ-C up to  $25^{\circ}\text{C}$  Evaporator Leaving Temperature. The option provides optimized evaporator and dedicated control function.

**Intelligent Chiller Manager - iCM Standard (opt. code 183)**

By selecting this option is possible to achieve the control of the primary loop without need of additional control panel.

In addition to the functionalities provided by Master/Slave with iCM Standard is possible to:

- Control mixed systems:
  - Chiller + Heat Pump
  - Chiller + multipurpose
- Manage manifolded pumps
- Manage the unit operation enhancing the system efficiency.  
 This functionality allows to further increase the system efficiency by setting different thresholds to share the load among the units installed in the most efficient configuration.

Manage at system level the following options:

- Rapid Restart
- Demand Limit
- Energy Monitoring
- Variable Primary Flow
- Variable flow based on  $\Delta T$

All the information from the slave's controller are available on the master unit's controller.

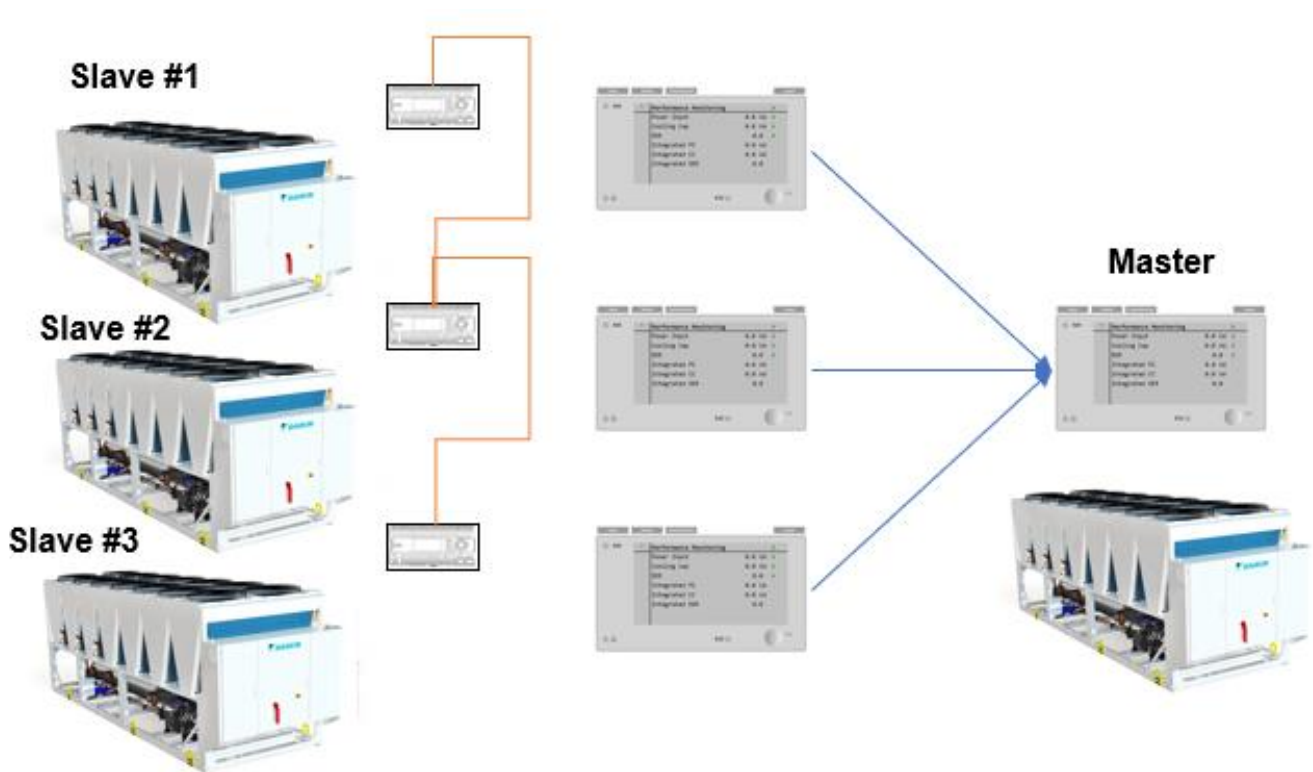

**Daikin on Site (DoS) modem with antenna (opt. code 155)**

With Daikin On Site it is possible to have complete access to the unit controller through the cloud. The unit is equipped with a modem and a GSM card providing autonomous internet connection. As alternative, a LAN connection can be used if available.

The main functionalities of DoS are:

- predefined set of data points (~300 to >500 per controller/plant);
- predefined Read/Write access to data points;
- predefined set of Dashboards;
- Functionality for Users to create their own Dashboards;
- Alarm application and Alarm history;
- Alarm notification via email;
- Scheduling of Alarm notification;
- WEB-Access to local HMI;
- Dynamic WEB-Graphic;
- Possibility to upgrade firmware and software from remote (For some user roles);
- History log for cloud-based user interactions (e.g. change of a set point);
- Scheduler application;
- Energy Monitoring;
- Documentation folder (E.g. release notes).

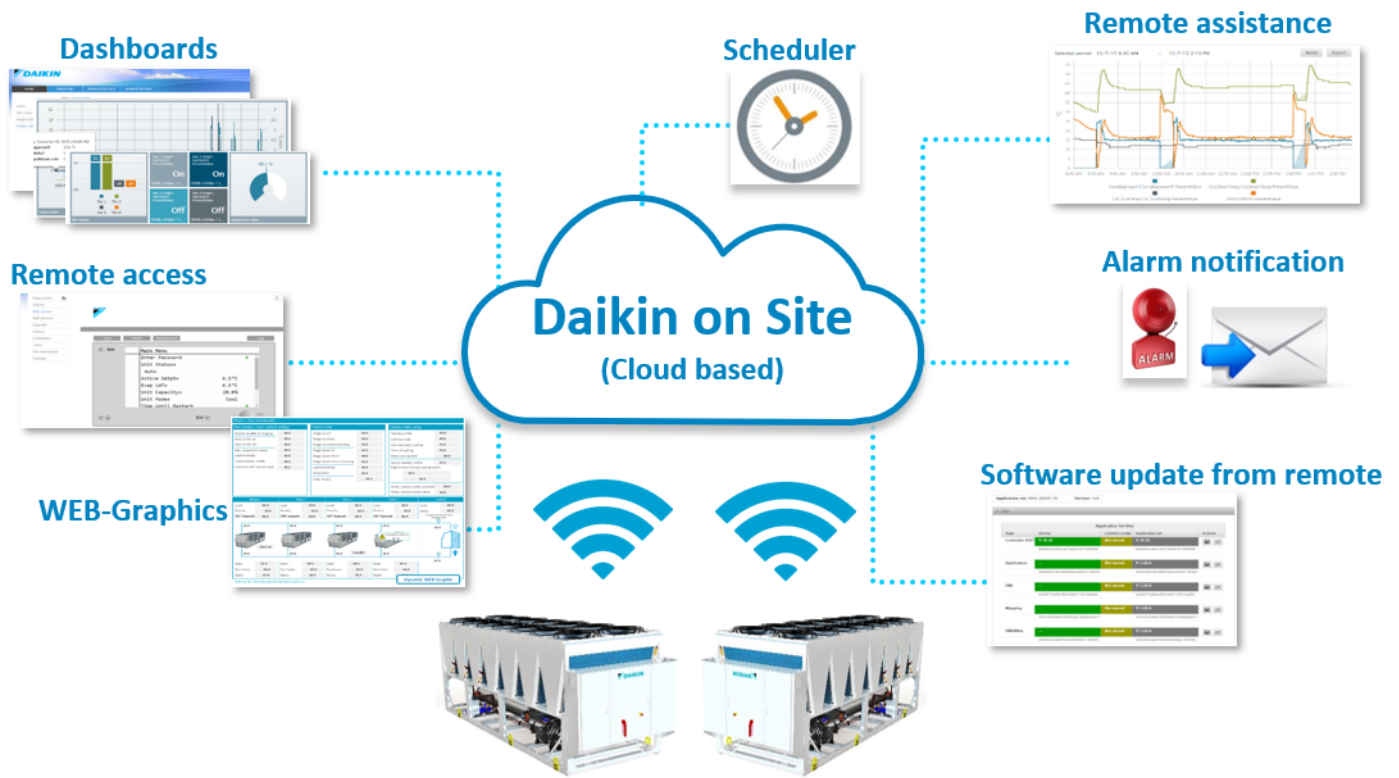

## Performance monitoring - (opt. code 185)

EWA(H)(D)~TZ-C is equipped with the new integrated Energy Monitoring system by Daikin. Results of extensive research and development activities, this patented solution allows to estimate the performance of the chiller. discharge. So, all data for standard units are referred to the following information are available from the unit HMI:

- Cooling Capacity
- Power input (compressors and fans)
- Energy Efficiency ratio – EER
- Integrated Cooling Capacity
- Integrated Power input (compressors and fans)
- Integrated Energy Efficiency ratio – EER

The screenshot shows a menu titled 'Performance Monitoring' with the following data:

Performance Monitoring	
Power Input	285,7 kW
Cooling Cap	1000 kW
EER	3,5
Integrated PI	161,9 kW
Integrated CC	680 kW
Integrated EER	4,2

The accuracy of the Energy monitoring is -/+ 5% at nominal condition and -/+ 10% for all other conditions. The energy monitoring system must be activated by selecting the opt. 185. As alternative all the information provided by the Energy Monitoring system are available is chiller is connected on Daikin On Site.

The subscription to DoS includes the visualization of above parameters in a dedicated dashboard.

## Installation options

**Rubber anti vibration mounts (opt. code 75)** Supplied separately, these are positioned under the base of the unit during installation. Ideal to reduce the vibrations when the unit is floor mounted.

**Spring anti vibration mounts (opt. code 77)** Supplied separately, these are positioned under the base of the unit during installation. Ideal for dampening vibrations for installation on roofs and metallic structures.

## Other options

**Transport kit (opt. code 71)**

**Container kit (opt. code 112)**

## Applications

DAIKIN TZ C range can be applied to supply chilled water or brine mixture in a wide range of temperatures at different ambient conditions. A proper chiller selection is key to achieve effective and reliable system operation. The unit must be selected according to the specific requirements for the project. Do not intentionally oversize the unit at design condition to ensure cooling capacity. An oversized chiller will be subject to frequent compressors cycling leading to inefficient operation.

In case an oversized system is required for the project, propose two smaller chillers connected in ICM Standard control.

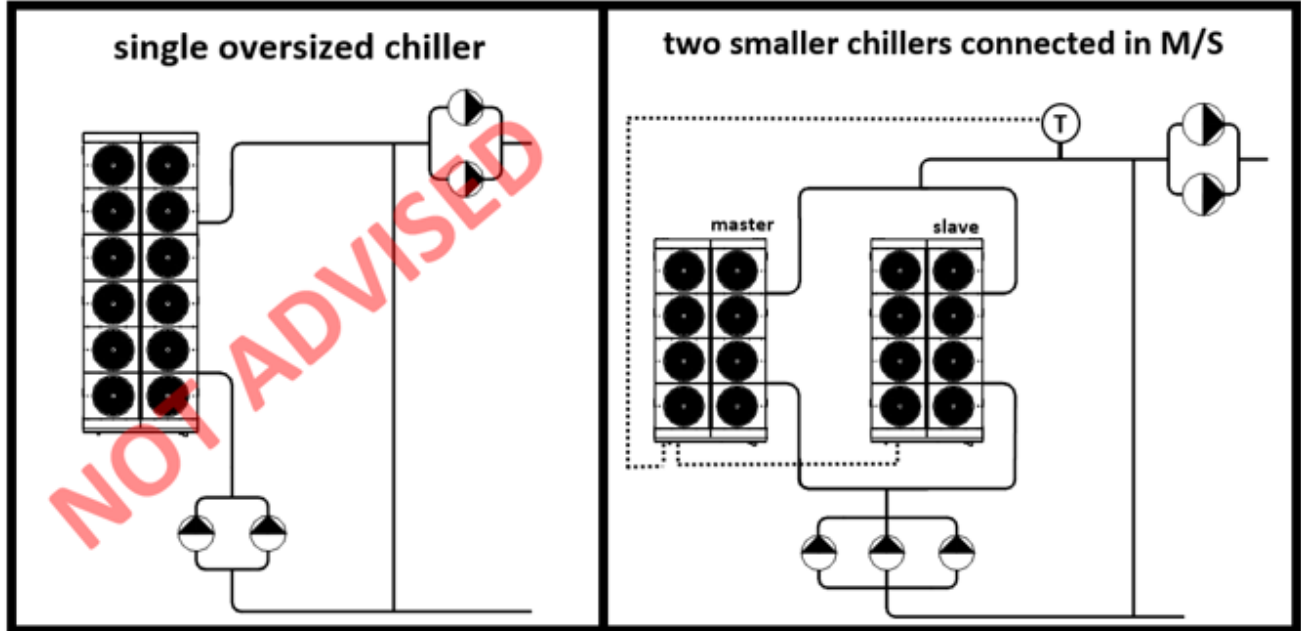

Some application could require water flow rate through the exchanger out of the allowed limits.

The limits for the water flow rate are defined as follow:

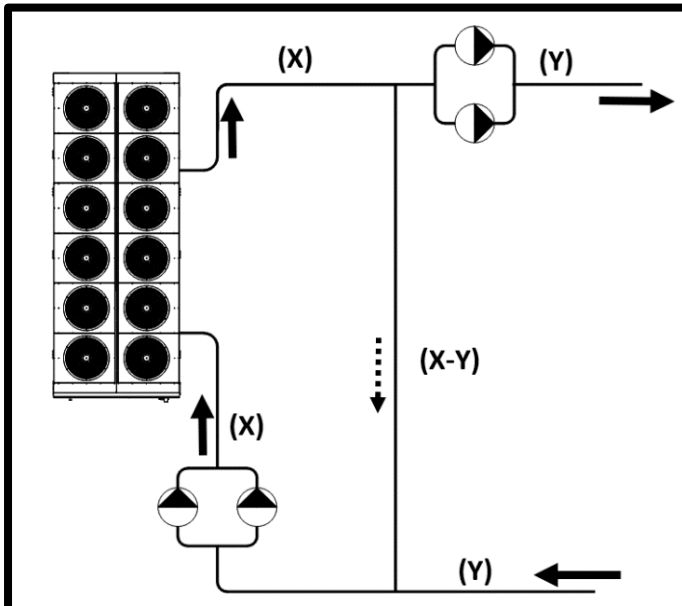

Maximum water flow rate → corresponding to water velocity equal to 1,5 m/s  
 Minimum water flow rate → corresponding to water velocity equal to 0,8 m/s

In case of selections with water flow rate below the minimum allowed a decoupled system is required.

Where:

- X is the minimum water flow rate allowed for the chiller.
- Y is the water flow rate required for the application

In this case  $Y < X$ , the required flow rate is lower than the minimum allowed for the chiller.

The decoupled system allows to operate with different water flow rate in primary and secondary circuit.

The decoupler must be sized to allow a water flow rate

equal to  $(X-Y)$  with negligible pressure drop ( $\sim 5$  kPa).

NOTE: the direction of the flow must be always from supply to return. With the flow in the opposite direction, the chilled water supply temperature in the secondary loop will rise to unacceptable levels.

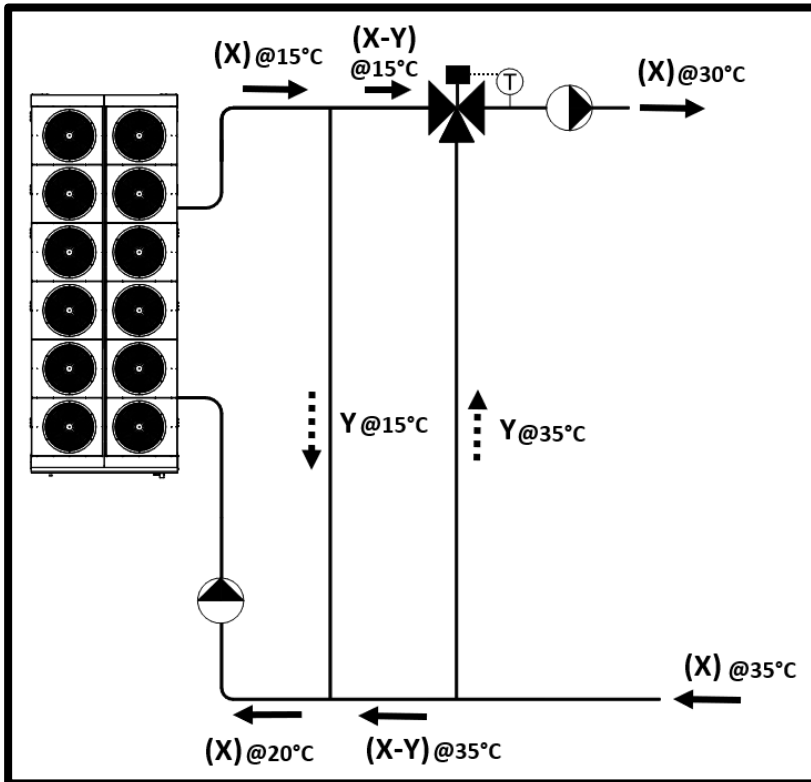

There are also limits on the water temperature (inlet and outlet) that must be respected. Refer to Operating limits chapter of this data book and to IOM specific values. When operation outside the allowed temperature is needed a proper arrangement of the hydronic circuit is needed.

As example we can consider a process requiring water supply (X) at 30°C and returning water at 35°C. Those temperatures are outside the operating envelope for the chiller. Since both entering and leaving water temperatures are outside the operating limit, in addition to the standard decoupled system, another branch is needed. This additional branch must be provided with a 3-ways valve acting as mixing valve in the direction of the supply water to the plant. We can select the chiller running at the 15°C outlet temperature with an entering of 20°C with same water flow rate required for the process (X). The return water from the secondary circuit at 30°C is divided is cooled by the cold water at 15°C from the open decoupler while the supply water is heated up by the return water coming from the additional branch controlled by the mixing valve. The set point for the mixing valve is fixed on the delivery water temperature (30°C). This system is required

when both entering and leaving water temperature are outside the operating envelope of the chiller.

If only the entering water temperature is outside the limit the previous scheme can be applied (single decoupler) paying attention to fix the proper water flow rate on primary circuit and dimensioning the decoupler accordingly.

Most of the chiller installation requires, in addition to chilled water, also heated water. The hot water can be used to post eat air in AHU's, for preparation of Sanitary Hot Water, and many other applications.

As explained in the option description, the heating is available only when the chiller is providing chilled water; for this reason, the evaluation of the actual heating capacity available requires also the information on the cooling load. In case of multiple chillers plant involving heat recovery chillers and standard chillers a proper plant configuration can be used to better exploit the heat recovery capability to enhance the system efficiency.

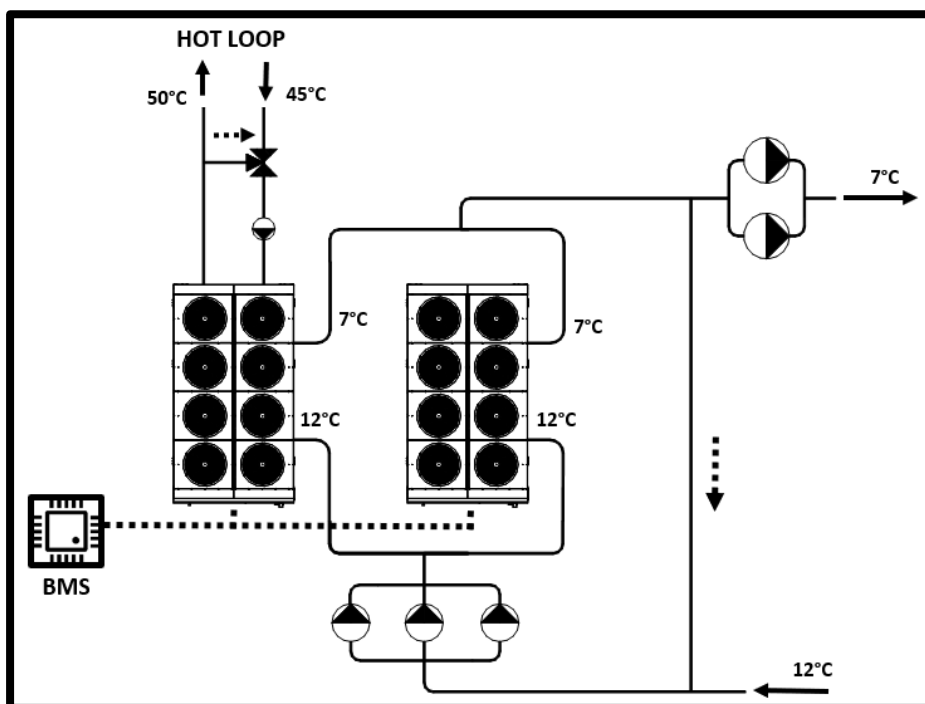

In typical decoupled systems with chillers installed in parallel is possible to manage the chiller operation through a BMS which gives priority to the chiller with heat recover capability.

All the chillers in operation (as enabled by the BMS system to match the load) see the same entering water temperature.

If BMS is not available to give priority on Heat recovery chiller is possible to use the set-point reset command to the chiller. When heating is required the set point on the heat recovery chiller is set to a lower value through a 0-10V signal; as result the chiller with heat recovery will charge more while the other will unload.

A way to assign a preferential load to the heat recovery chiller is by moving it to the secondary plant (on the other side of the decoupler).

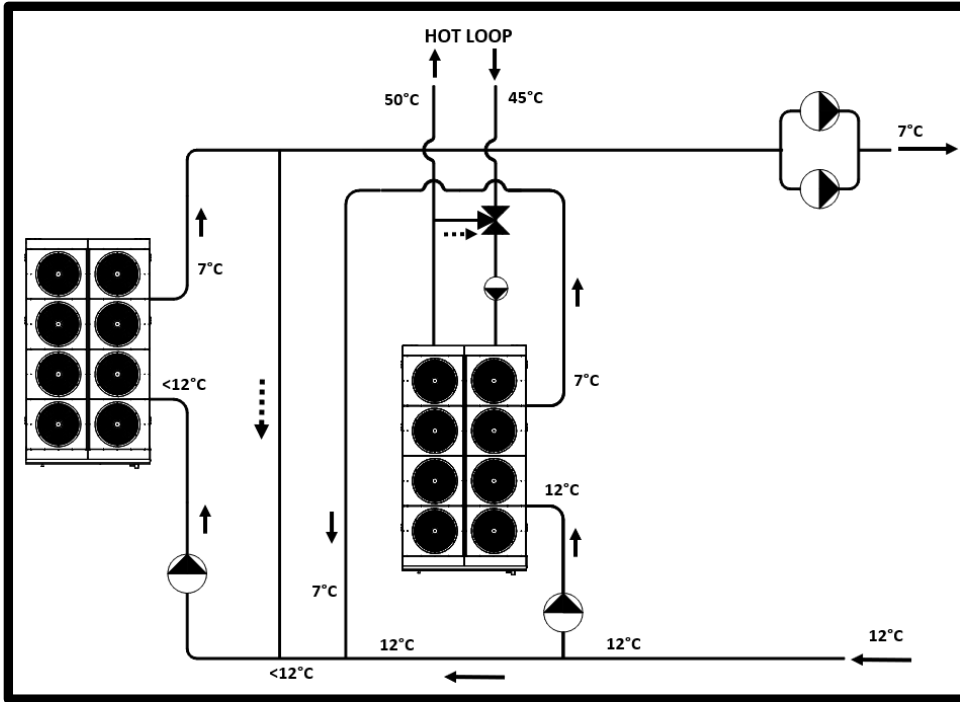

In with this layout the heat recovery chiller is loaded preferentially because it always receives the warmest return-water temperature (12°C). The chiller is fully loaded as it has to deliver the desired chilled water temperature (7°C set point). As consequence, the heat recovery is the maximum possible and may eventually exceed the heating load.

In case of an air-cooled heat recovery chiller, without external control, the unit will cycle between heat recovery ON and OFF operation, rejecting the exceeding heat rejection through the air-cooled condenser.

With external BMS or using the set-point reset function is possible to modulate the cooling

capacity to the one corresponding to the actual heating need. The extra cooling capacity which cannot be delivered by the heat recovery chiller, will be transferred to the standard chillers in the production loop. This will optimize the energy usage of the entire chiller plant and the heat recovery operation will be limited to exactly the heating need.

In addition to the previous layout, another solution is to install the heat recovery chiller in side stream position.

In this configuration the chiller located in a side-stream position, takes the supply water from the main return pipe, cools this water as much as desired to make the heat recovery matching the heating requirement (controlling the chiller capacity with BMS or through the set point reset command). This is usually obtained through a Building Management System that will reset accordingly the chilled water leaving water temperature set point. The cooled water will return to the main return water pipe and mix with the main return water flow, cooling the return water entering the remaining chillers.

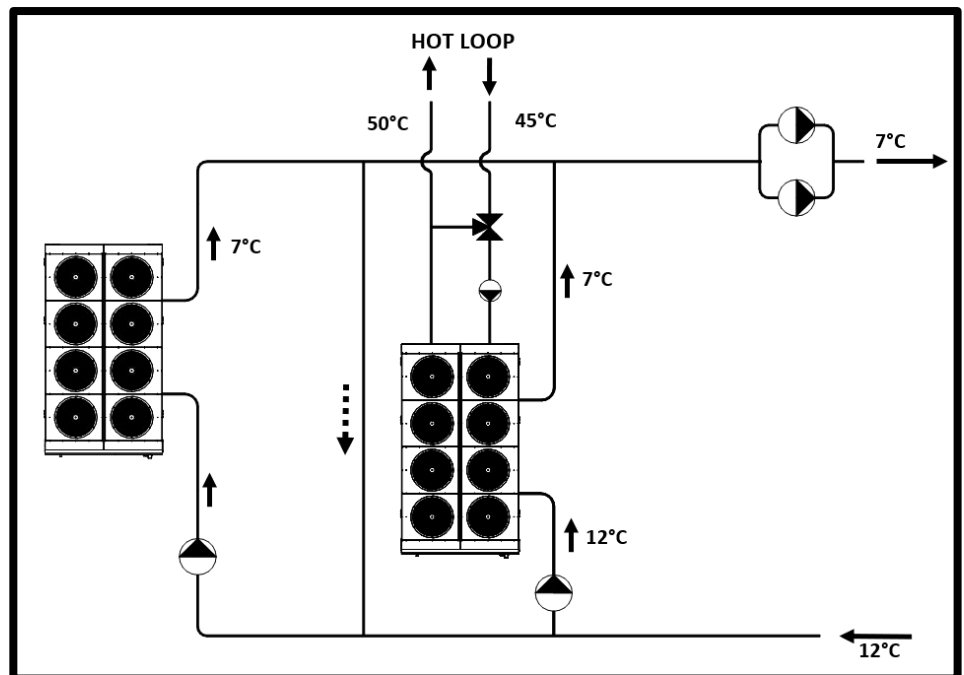



Compare to previous layout (heat recovery chiller in parallel positioned on distribution side) the Side stream configuration allows to control the heat recovery chiller on the hot energy needed, without effect on the supply water temperature. To optimized system operation the heat recovery chiller should be selected based on the heating capacity at full load. For the heat recovery chiller in this application the cooling capacity represents the side effect of the heating operation. The cooling only chiller in the production line must be able to provide the extra cooling capacity needed when minimum heating capacity is required. In case cooling load required is much higher than the heating load a cheaper and affective solution could be to use of a water to water heat pump installed Side stream on the cooling loop.

The heat pump selected based on the heating capacity will modulate the capacity according the heating load.

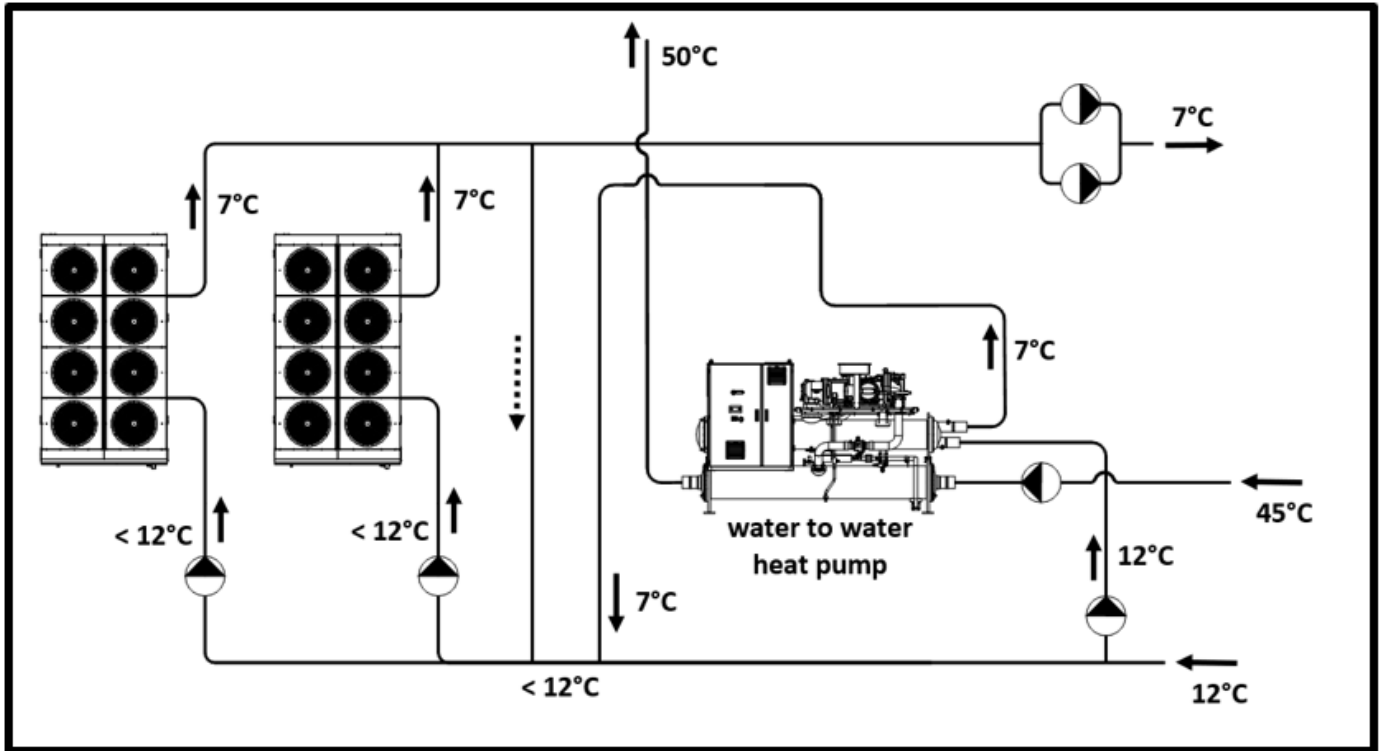



## How to enhance the system efficiency with iCM Standard

In case of multiple chiller installations DAIKIN TZ C provides an advanced sequencing management without the need of additional controllers. For systems up to 4 units DAIKIN ICM Standard control allows to optimize the efficiency of the whole system by sequencing the unit according a predetermined strategy.

Is possible to connect units of same or different sizes from the same chiller range (in this case EWA(H)(D)~TZ and EWAD~T- can be connected).

Once the unit are installed and wired, the user must assign through the HMI the roles (master and slaves) to each unit.

The default settings are defined as follow:

- NO chiller priority → the chiller will be activated based on the running hours
- Load sharing on 60% of the chiller capacity

In case of units of same sizes there is no practical reason to assign different priorities to the units, while in case of system combining unit with different sizes or VFD screw chillers (DAIKIN TZC) with fix speed screw chillers (DAIKIN T-B) to optimize the efficiency it may be needed. For this situation in possible to assign priorities to the units connected

Setpoint/Sub-Menu	Default	Range	Description
Master Priority=	1	1...4	Start Up / Shut Down priority of the chiller Master Priority = 1 → highest priority Priority = 4 → lowest priority
Slave 1 Priority=	1	1...4	Start Up / Shut Down priority of the chiller Slave 1 Priority = 1 → highest priority Priority = 4 → lowest priority
Slave 2 Priority=	1	1...4	Start Up / Shut Down priority of the chiller Slave 2. Priority = 1 → highest priority Priority = 4 → lowest priority This menu is visible only if the parameter M/S Num Of Unit has been configured at least with value 3
Slave 3 Priority=	1	1...4	Start Up / Shut Down priority of the chiller Slave 3. Priority = 1 → highest priority Priority = 4 → lowest priority This menu is visible only if the parameter M/S Num Of Unit has been configured at least with value 4
Master Enable=	Enable	Enable Disable	This parameter allows to enable or disable locally the Master Chiller
Control Mode=	Complete	Partial Complete	Parameter to select the Partial or Complete control mode Partial → On/Off control Complete → On/Off + Capacity control
Control Tmp=	Leaving	Entering Leaving	Parameter to define the controlled temperature Entering - Thermoregulations is based on the Average Entering Water Temperature (AEWT) Leaving - Thermoregulation is based on the Common Leaving Water Temperature (CLWT)

The thermostat control for DAIKIN units is by default on the Evaporator Leaving Water Temperature (ELWT). In iCM Standard system the default thermostat control is also on the leaving water temperature. To keep this function an additional temperature sensor must be installed and connected to the master unit. on the common line of the hydraulic circuit and connected to the Master unit. The temperature sensor can be an NTC10K or PT1000. The temperature sensor is not provided by the factory.

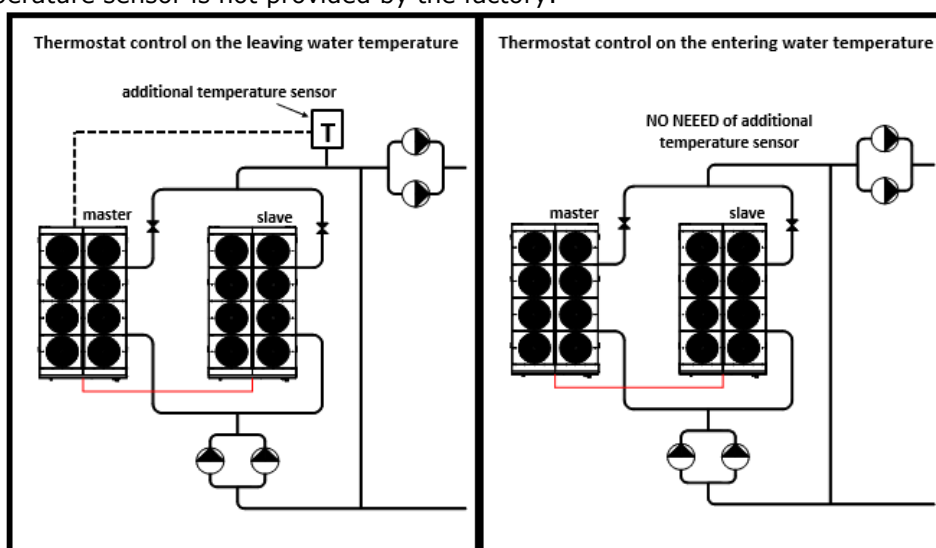

As alternative is possible to enable the thermostat control on Evaporating Entering Water Temperature (EEWT). In this case there is no need of additional temperature sensor.

Once chosen the control method (based on ELWT or EEWT) is possible to manage the thermostat control from the HMI interface on the Master units.

Setpoint/Sub-Menu	Default	Range	Description
Stage Up DT=	2.7°C	0.5...5.0°C	Offset respect the active setpoint for the unit startup.
Stage Dn DT =	1.5°C	0.5...5.0°C	Offset respect the active setpoint for the unit shutdown.
Dead Band =	0.2	0.1 - Min(Stage UP DT, Stage Dn DT)	Dead Band respect the active setpoint within which the load/unload command are no longer generated
Threshold=	60%	30...100%	Threshold of load that have to reach all units running before start of a new chiller
Stage Up Time=	5min	0min...20min	Minimum time between the start of two chillers
Stage Dn Time=	5min	0min...20min	Minim time between the stop of two chillers
Min Evap Tmp=	4.0	-18...30°C	Minimum Evaporator leaving water temperature

For detailed description of all the settings refer to the user manual.

The Threshold parameter allows to assign a load threshold that each unit must reach before starting a new chiller. The default value is 60%, is possible to set value from 30% up to 100%. Lower the threshold, higher will be the number of the active chillers sharing equally the cooling demand, while with threshold at 100% the chiller will operate in pure staging. Each chiller needs to run at 100% before to start the next chiller. With this setting the number of active chillers is minimized.

The below graphs show a schematic of the sharing and staging operation. The example is based on a system with 3 TZ C units of same capacity (no priority assigned).

**Sharing operation with threshold at 30% (max sharing possible)**

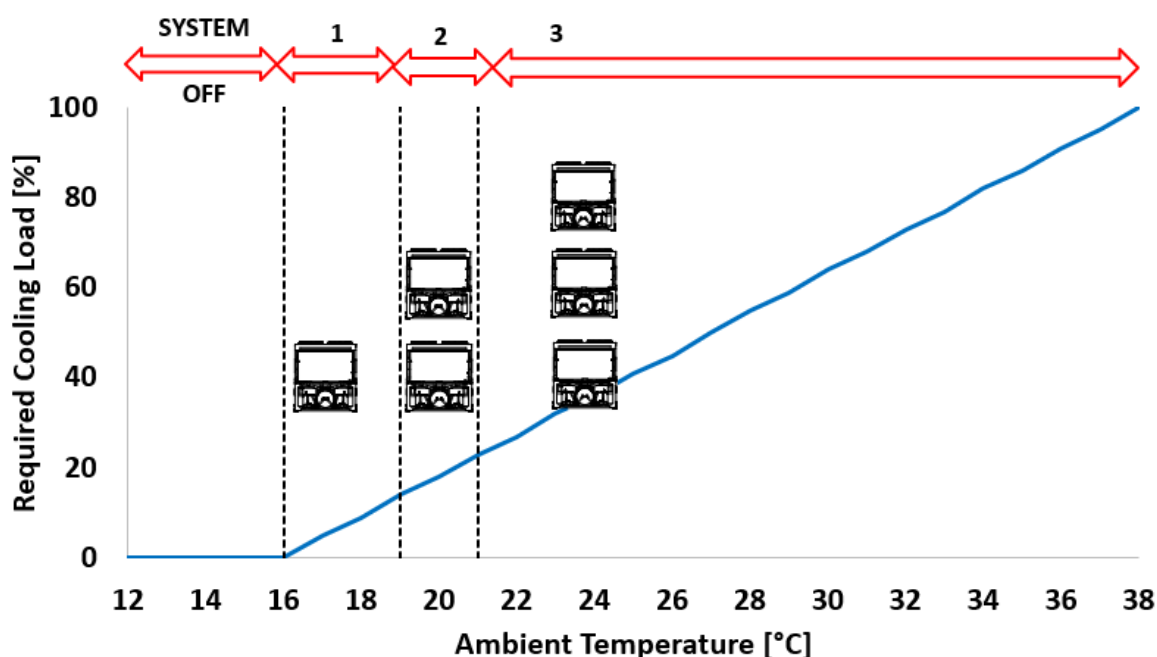

With the threshold at 30%, the first chiller starts at 17°C, as the required load increases the chiller charges until it reaches the 30% of his capacity (which happens at 18°C). Since the 1 chiller has reached the load threshold, the second chiller starts. The first chiller keeps the capacity at 30% while the second chillers charges until it also reaches the 30 % of the load (in the example occurs at 21°C). Than also the third chiller is starts. The others keep the capacity at 30% until also the third chiller reaches the 30% capacity. From that point the chillers charge all together, sharing equally the required load up to 100%.

Whit this strategy the number of active chillers is maximized, and the chillers operate most of the time at part load.

Pure Staging operation with threshold at 100%

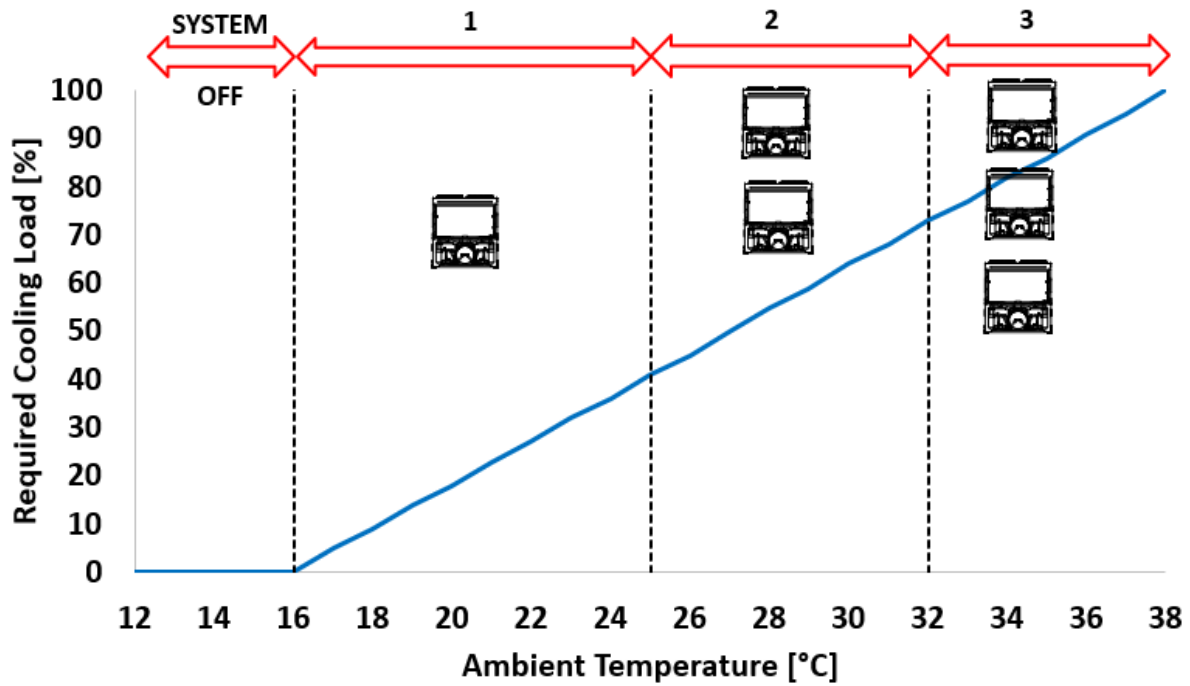

Setting the load threshold at 100% the system controls will be pure staging. The next unit is not started until the units already running have reached 100% of their capacity. With this setting the number of units ON is minimized. The evaluation of the optimum threshold value should consider different factors such as:

- Chiller type (VFD or fixed speed) and so their part load efficiency
- Number of units involved and sizes (all same size or different sizes)
- Eventual assigned priorities
- Cold loop layout (primary/secondary or only primary) and management (fix or variable water flow rate)

Another important aspect to be evaluated is the load required over the climatic profile of the specific installation.

To give a clear idea we can provide a practical example.

The graph below shows a typical energy profile required for comfort cooling application.

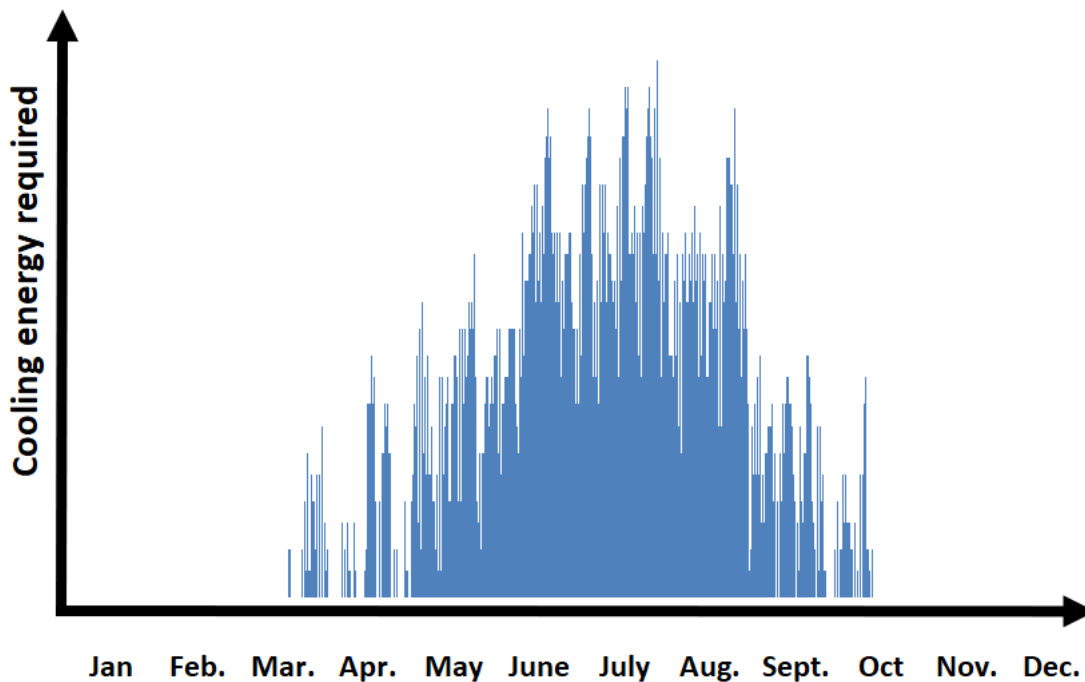

The same cooling profile can be represented over the temperatures, together with the indication of how many hours each temperature recurs during the year.

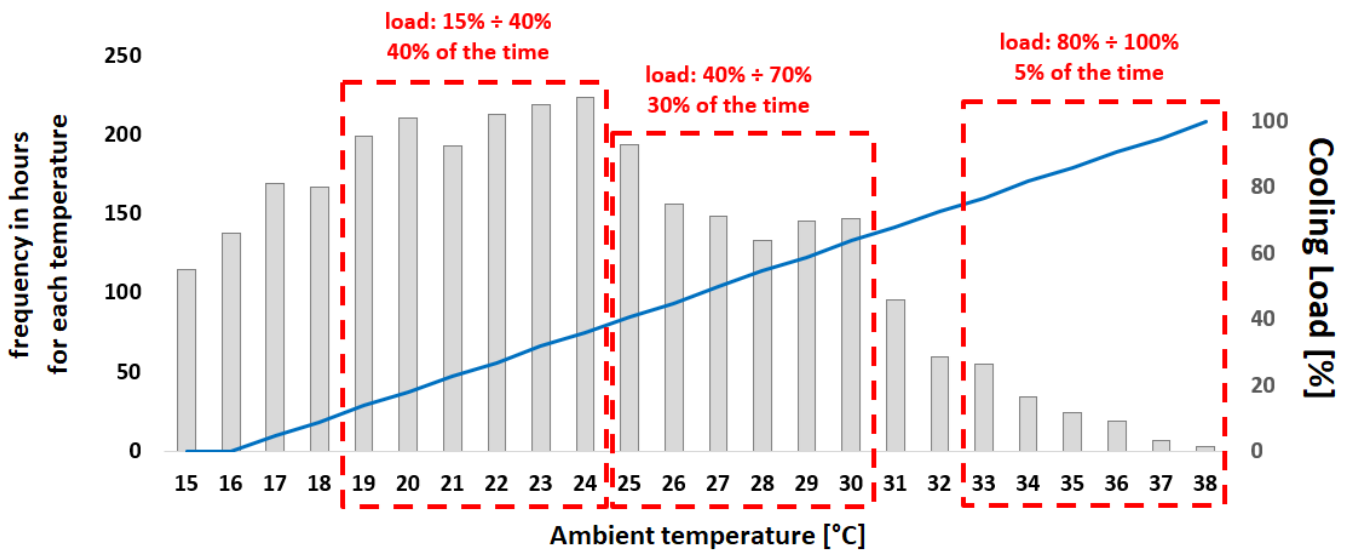

From the above graph is possible to evaluate how the system will operate and so, identify the most recurring condition. Knowing how the cooling load is distributed throughout the season is possible to set the system reaching the highest frequency possible for the most recurring condition.

To better understand we can try three different sequencing strategies:

1. Minimize the number of chillers ON → Threshold = 100%
2. Optimize medium temperature operation (between 25°C and 30°C) → Threshold = 60%
3. Optimize lower temperature operation (between 19°C and 24°C) → Threshold = 30%

The plant considered is for 3 units of same size 1 MW each. The pumps on primary plant are fixed speed. Each chiller enable the related pump when is called to start. Pressure drop on primary loop equal to 100 kPa with the 3 chillers ON.

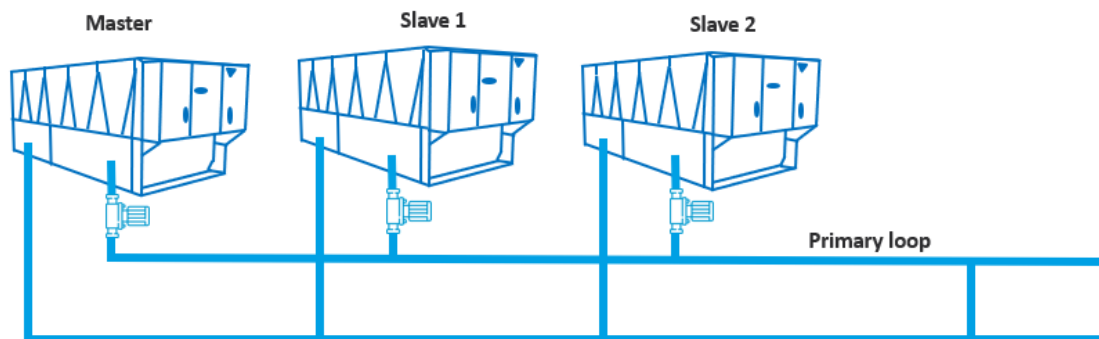

The below graph shows the trend of the power input for the pumps on the primary loop according to the number of active chillers

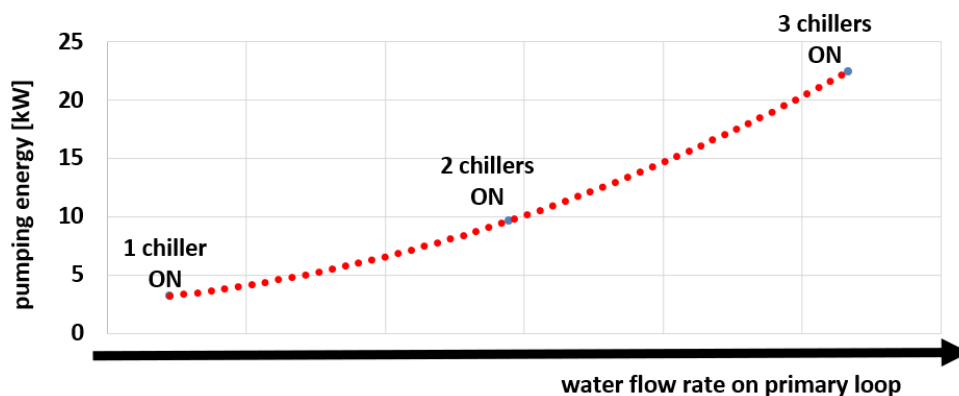

The following graph and table show the efficiency trend and the resulting energy consumption over the cooling season for the different threshold values

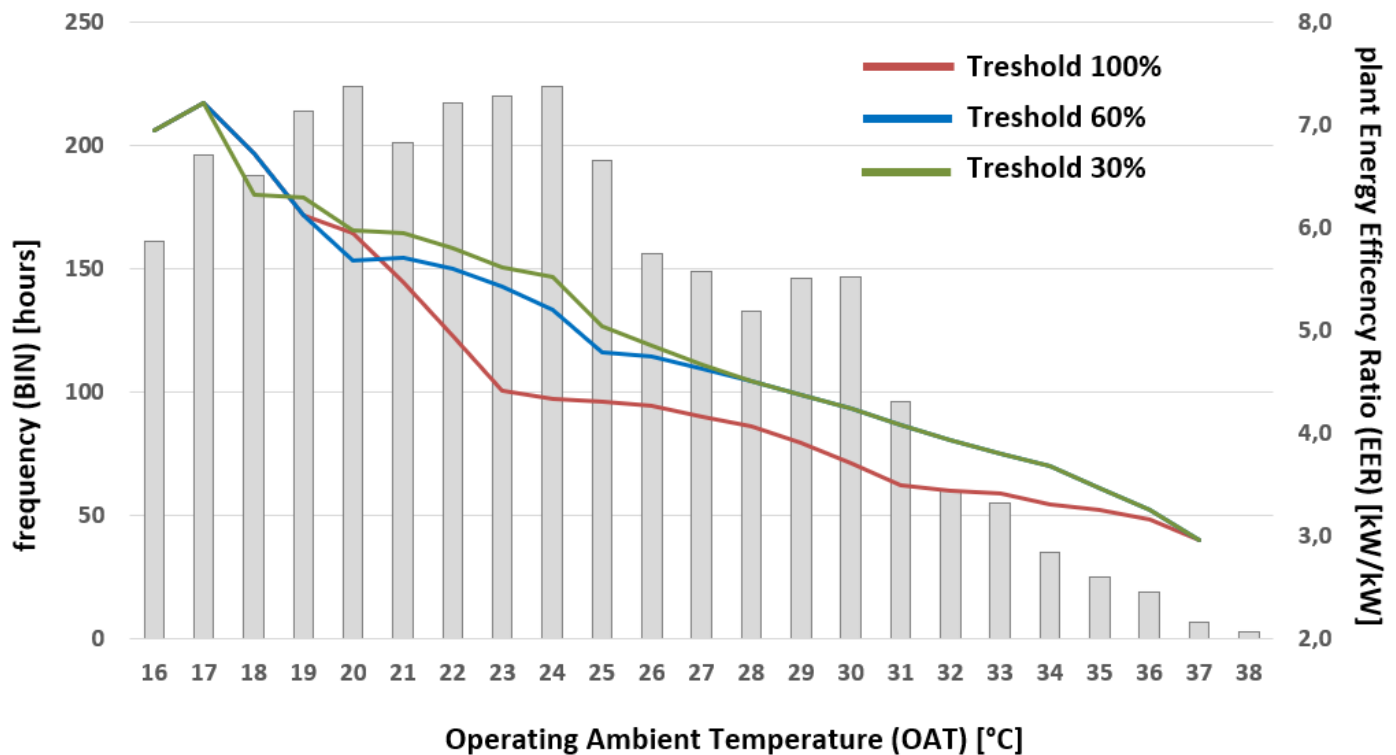

OA T [°C]	BIN [hours]	Plant load [kW]	Threshold 100%				Threshold 60%				Threshold 30%			
			Power input		EER	Energy [kWh]	Power input		EER	Energy [kWh]	Power input		EER	Energy [kWh]
			chillers	pumps	Inc. pumps		chillers	pumps	Inc. pumps		chillers	pumps	Inc. pumps	
			[kW]	[kW]	[kW/kW]	[kW]	[kW/kW]	[kW/kW]	[kW]	[kW]	[kW/kW]	[kW]	[kW]	[kW/kW]
16	161	0	-	-	-	-	-	-	-	-	-	-	-	-
17	196	150	18,4	3,2	6,9	4232	18,4	3,2	6,9	4232	18,4	3,2	6,9	4232
18	188	270	34,2	3,2	7,2	7041	34,2	3,2	7,2	7041	34,2	3,2	7,2	7041
19	214	420	59,2	3,2	6,7	13368	59,2	3,2	6,7	13368	56,8	9,7	6,3	14222
20	224	540	84,9	3,2	6,1	19742	84,9	3,2	6,1	19742	76,1	9,7	6,3	19210
21	201	690	113	3,2	5,9	23311	112	9,7	5,7	24422	106	9,7	6,0	23213
22	217	810	145	3,2	5,5	32145	132	9,7	5,7	30776	127	9,7	5,9	29566
23	220	960	190	3,2	5,0	42615	162	9,7	5,6	37709	156	9,7	5,8	36423
24	224	1080	241	3,2	4,4	54724	189	9,7	5,4	44569	182	9,7	5,6	43033
25	194	1230	274	9,7	4,3	55076	227	9,7	5,2	45885	213	9,7	5,5	43233
26	156	1350	303	9,7	4,3	48813	260	22,5	4,8	44028	245	22,5	5,0	41793
27	149	1500	341	9,7	4,3	52315	294	22,5	4,7	47089	286	22,5	4,9	45998
28	133	1650	386	9,7	4,2	52652	334	22,5	4,6	47384	331	22,5	4,7	47052
29	146	1770	425	9,7	4,1	63490	370	22,5	4,5	57243	370	22,5	4,5	57340
30	147	1920	480	9,7	3,9	72056	416	22,5	4,4	64524	416	22,5	4,4	64524
31	96	2040	539	9,7	3,7	52699	458	22,5	4,2	46164	458	22,5	4,2	46164
32	60	2190	605	22,5	3,5	37636	514	22,5	4,1	32192	514	22,5	4,1	32192
33	55	2310	648	22,5	3,4	36874	565	22,5	3,9	32298	565	22,5	3,9	32298
34	35	2460	697	22,5	3,4	25179	624	22,5	3,8	22639	624	22,5	3,8	22639
35	25	2580	756	22,5	3,3	19450	679	22,5	3,7	17535	679	22,5	3,7	17535
36	19	2730	814	22,5	3,3	15890	765	22,5	3,5	14956	765	22,5	3,5	14956
37	7	2850	878	22,5	3,2	6302	851	22,5	3,3	6112	851	22,5	3,3	6112
38	3	3000	990	22,5	3,0	3038	990	22,5	3,0	3038	990	22,5	3,0	3038
<b>Total energy [kWh]</b>			<b>738646</b>				<b>662946</b>				<b>651813</b>			

The efficiency trend over the temperature shows how the different thresholds used for the ICM Standard sequencing gives different results. The energy consumption over the full cooling season for the primary plant (chillers + primary pumps) reduces from 738646 kWh down to 651813 kWh modifying the threshold. Same components (chillers and pumps) gives much lower energy consumption, and so lower running costs, just setting the right threshold.

- 1. Threshold = 100% → 738646 kwh**
- 2. Threshold = 60% → 662946 kwh (-10,0 % vs Threshold = 100%)**
- 3. Threshold = 30% → 651813 kwh (-11,8 % vs Threshold = 100%)**

From going from 100% to 60% of threshold the increase in efficiency is noticeable, while going down from 60 to 30% the difference is much lower. This difference is strongly affected by the pumping energy. In case of higher pressure drops on primary loop the difference would be even lower or in favor of the 60%. While a system with variable flow would give higher benefits to a configuration with 30% threshold. A proper evaluation of the pumping energy costs is key to find the best threshold set.

Many additional factors can be considered to achieve even higher energy savings like:

- If there are different cost for electricity based on time bands
- systems with variable flow
- in case of system made by different unit sizes and technologies (fix speed and VFD) choose the proper priority.

EWAH~TZ- SS C – standard unit								
MODEL	notes		710	770	880	940	990	H10
Cooling Capacity	(1)	kW	712,3	765,6	879,4	942,8	990,6	1056
Power Input	(1)	kW	231	247	285	304	319	339
EER	(1)	kW/kW	3,09	3,10	3,09	3,10	3,11	3,11
Minimum capacity	(2)	%	12,5	12,5	12,5	12,5	12,5	12,5
SEER	(3)	kW/kW	4,61	4,65	4,63	4,62	4,65	4,61
$\eta_{s,c}$	(4)	%	181	183	182	182	183	181
SEER + opt99a	(3)	kW/kW	5,16	5,20	5,17	5,13	5,25	5,20
$\eta_{s,c}$ + opt99a	(4)	%	203	205	204	202	207	205
Evaporator type								
		-	Direct Expansion – Shell & Tubes					
Water flow rate	(1)	l/s	34,0	36,5	41,9	45,0	47,2	50,3
Evaporator pressure drop	(1) (7)	kPa	44,6	50,8	59,7	67,7	59,9	67,2
Evaporator water volume	(8)	lt	280	280	492	492	583	583
Minimum water rate	(6)	l/s	12,9	12,9	12,3	12,3	14,6	14,6
Sound Power								
	(1) (8)	dB(A)	101	101	102	103	104	105
Sound Pressure @ 1 m								
	(1) (9)	dB(A)	80	80	80	81	82	82
Fan type								
		-	Direct Propeller					
Fan diameter								
		mm	800					
Fan rotational speed								
		RPM	900					
Fan motor / control								
		-	AC – On/Off					
Number of fans								
		n	14	14	16	18	20	22
Power input fans								
		kW	24,5	24,5	28,0	31,5	35,0	38,5
Air flow								
	(10)	l/s	71008	71008	81152	91296	101440	111584
Refrigerant circuits								
		n	2	2	2	2	2	2
Refrigerant type / GWP								
		-	R1234ze(E) / GWP = 7					
Refrigerant Charge								
	(11)	kg	120	120	130	141	150	175
Compressor type								
		-	Single Screw					
Capacity control								
		-	Stepless – Variable Frequency Drive					
Oil charge								
		lt	16	16	16	16	16	16
Casing material								
		-	Galvanized Steel Sheet					
Color								
		-	Ivory White					
Unit length								
		mm	6909	6909	7809	8709	9602	10510
Unit width								
		mm	2280	2280	2280	2280	2280	2280
Unit height								
		mm	2540	2540	2540	2540	2540	2540
Unit weight - shipping								
		kg	7033	7033	7660	8093	8900	9288
Unit weight - operation								
		kg	7313	7313	8152	8585	9483	9871
Water connection size								
		mm	168,3	168,3	219,1	219,1	219,1	219,1
Water connection type								
		-	Victaulic					
<p>(1) Standard Rating Conditions for Air to water chillers according to EN14511:2 Outdoor Heat exchanger inlet dry bulb temperature 35°; Indoor heat exchanger inlet water temperature 12°C, outlet water temperature 7°C. Fouling factor = 0</p> <p>(2) Minimum capacity for the unit operating at Standard Rating Conditions: Operating Ambient Temperature 35°C, Evaporator, water outlet 7°C</p> <p>(3) Seasonal Energy Efficiency Ratio as defined in EN14825, part load condition in cooling for Air to Water units, fan coil application, variable outlet, variable flow.</p> <p>(4) the seasonal space cooling energy efficiency <math>\eta_{s,c}</math> is calculated as defined in Regulation (EU) 2016/2281 the seasonal energy efficiency ratio SEER divided by the conversion coefficient CC (2.5), corrected by contributions accounting for temperature control (0.03).</p> <p>(5) Seasonal energy performance Ratio as defined in Regulation (EU) 2016/2281 for a high temperature process chiller at standard rating conditions defined in EN14511:2</p> <p>(6) minimum flow rate to be reached in variable water flow system (not managed by the unit controller BMS) with unit operating at minimum load.</p> <p>(7) not including filter pressure drop. The installation of the filter is mandatory.</p> <p>(8) sound power level measured in accordance to ISO9614, referred to unit operating at Standard Rating Conditions for Air to water chillers according to EN14511:2 Outdoor Heat exchanger inlet dry bulb temperature 35°; Indoor heat exchanger inlet water temperature 12°C, outlet water temperature 7°C</p> <p>(9) sound power level measured in accordance to ISO3744, referred to unit operating at Standard Rating Conditions for Air to water chillers according to EN14511:2 Outdoor Heat exchanger inlet dry bulb temperature 35°; Indoor heat exchanger inlet water temperature 12°C, outlet water temperature 7°C</p> <p>(10) referred to unit with free discharge on condenser fans.</p> <p>(11) data subject to change. Refer to unit's name plate for actual value.</p>								
<p>■ Data certified by Eurovent certification scheme</p> <p>The above data are referred to the unit without additional optional.</p> <p>The above data are referred the unit installed in compliancy with installation prescription.</p> <p>All the data are subject to change without notice. For updated information on project base refer to Chiller Selection Software and unit's certified drawing</p>								



EWAH~TZ- SS C – standard unit								
MODEL	notes		C11	C12	C13	C14	C15	C16
Cooling Capacity	(1)	kW	1117	1231	1302	1432	1519	1603
Power Input	(1)	kW	357	396	418	465	510	567
EER	(1)	kW/kW	3,13	3,11	3,11	3,08	2,98	2,83
Minimum capacity	(2)	%	12,5	12,5	12,5	12,5	12,5	12,5
SEER	(3)	kW/kW	4,63	4,56	4,92	4,88	4,84	4,80
$\eta_{s,c}$	(4)	%	182	179	194	192	191	189
SEER + opt99a	(3)	kW/kW	5,26	5,15	5,48	5,47	5,42	5,38
$\eta_{s,c}$ + opt99a	(4)	%	207	203	216	216	214	212
Evaporator type								
		-	Direct Expansion – Shell & Tubes					
Water flow rate	(1)	l/s	53,3	58,7	62,1	68,3	72,4	76,5
Evaporator pressure drop	(1) (7)	kPa	44,3	52,7	38,7	45,9	51,0	56,3
Evaporator water volume	(8)	lt	1043	1043	1011	1011	1011	1011
Minimum water rate	(6)	l/s	18,1	18,1	22,7	22,7	22,7	22,7
Sound Power								
	(1) (8)	dB(A)	106	107	105	106	107	108
Sound Pressure @ 1 m	(1) (9)	dB(A)	83	84	83	83	84	85
Fan type								
		-	Direct Propeller					
Fan diameter		mm	800					
Fan rotational speed		RPM	900					
Fan motor / control		-	AC – On/Off					
Number of fans		n	24	26	24	26	28	30
Power input fans		kW	42,0	45,5	42,0	45,5	49,0	52,5
Air flow	(10)	l/s	121728	131872	121728	131872	142016	152160
Refrigerant circuits								
		n	2	2	2	2	2	2
Refrigerant type / GWP		-	R134a / GWP = 1430					
Refrigerant Charge	(11)	kg	200	220	200	220	250	270
Compressor type								
		-	Single Screw					
Capacity control		-	Stepless – Variable Frequency Drive					
Oil charge		lt	16	16	25	25	25	25
Casing material								
		-	Galvanized Steel Sheet					
Color								
		-	Ivory White					
Unit length		mm	11402	12302	11402	12302	13202	14102
Unit width		mm	2280	2280	2280	2280	2280	2280
Unit height		mm	2540	2540	2540	2540	2540	2540
Unit weight - shipping		kg	10073	10475	10716	11134	11564	12037
Unit weight - operation		kg	11116	11518	11727	12145	12575	13048
Water connection size		mm	273,0	273,0	273,0	273,0	273,0	273,0
Water connection type								
			Victaulic					
<p>(1) Standard Rating Conditions for Air to water chillers according to EN14511:2 Outdoor Heat exchanger inlet dry bulb temperature 35°; Indoor heat exchanger inlet water temperature 12°C, outlet water temperature 7°C. Fouling factor = 0</p> <p>(2) Minimum capacity for the unit operating at Standard Rating Conditions: Operating Ambient Temperature 35°C, Evaporator, water outlet 7°C</p> <p>(3) Seasonal Energy Efficiency Ratio as defined in EN14825, part load condition in cooling for Air to Water units, fan coil application, variable outlet, variable flow.</p> <p>(4) the seasonal space cooling energy efficiency <math>\eta_{s,c}</math> is calculated as defined in Regulation (EU) 2016/2281 the seasonal energy efficiency ratio SEER divided by the conversion coefficient CC (2.5), corrected by contributions accounting for temperature control (0.03).</p> <p>(5) Seasonal energy performance Ratio as defined in Regulation (EU) 2016/2281 for a high temperature process chiller at standard rating conditions defined in EN14511:2</p> <p>(6) minimum flow rate to be reached in variable water flow system (not managed by the unit controller BMS) with unit operating at minimum load.</p> <p>(7) not including filter pressure drop. The installation of the filter is mandatory.</p> <p>(8) sound power level measured in accordance to ISO9614, referred to unit operating at Standard Rating Conditions for Air to water chillers according to EN14511:2 Outdoor Heat exchanger inlet dry bulb temperature 35°; Indoor heat exchanger inlet water temperature 12°C, outlet water temperature 7°C</p> <p>(9) sound power level measured in accordance to ISO3744, referred to unit operating at Standard Rating Conditions for Air to water chillers according to EN14511:2 Outdoor Heat exchanger inlet dry bulb temperature 35°; Indoor heat exchanger inlet water temperature 12°C, outlet water temperature 7°C</p> <p>(10) referred to unit with free discharge on condenser fans.</p> <p>(11) data subject to change. Refer to unit's name plate for actual value.</p>								
<p>Data certified by Eurovent certification scheme</p> <p>The above data are referred to the unit without additional optional.</p> <p>The above data are referred the unit installed in compliancy with installation prescription.</p> <p>All the data are subject to change without notice. For updated information on project base refer to Chiller Selection Software and unit's certified drawing</p>								

EWAH~TZ- SL C – standard unit								
MODEL	notes		710	770	880	940	990	H10
Cooling Capacity	(1)	kW	712,3	765,6	879,4	942,8	990,6	1056
Power Input	(1)	kW	231	247	285	304	319	339
EER	(1)	kW/kW	3,09	3,10	3,09	3,10	3,11	3,11
Minimum capacity	(2)	%	12,5	12,5	12,5	12,5	12,5	12,5
SEER	(3)	kW/kW	4,61	4,65	4,63	4,62	4,65	4,61
$\eta_{s,c}$	(4)	%	181	183	182	182	183	181
SEER + opt99a	(3)	kW/kW	5,16	5,20	5,17	5,13	5,25	5,20
$\eta_{s,c}$ + opt99a	(4)	%	203	205	204	202	207	205
Evaporator type								
		-	Direct Expansion – Shell & Tubes					
Water flow rate	(1)	l/s	34,0	36,5	41,9	45,0	47,2	50,3
Evaporator pressure drop	(1) (7)	kPa	44,6	50,8	59,7	67,7	59,9	67,2
Evaporator water volume	(8)	lt	280	280	492	492	583	583
Minimum water rate	(6)	l/s	12,9	12,9	12,3	12,3	14,6	14,6
Sound Power								
Sound Power	(1) (8)	dB(A)	98	98	99	100	101	101
Sound Pressure @ 1 m	(1) (9)	dB(A)	77	77	77	78	78	79
Sound Power + opt76b	(1) (8)	dB(A)	97	97	98	98	99	99
Sound Pressure @ 1 m + opt76b	(1) (9)	dB(A)	76	76	76	77	77	77
Fan type								
		-	Direct Propeller					
Fan diameter		mm	800					
Fan rotational speed		RPM	900					
Fan motor / control								
		-	AC – On/Off					
Number of fans		n	14	14	16	18	20	22
Power input fans		kW	24,5	24,5	28,0	31,5	35,0	38,5
Air flow	(10)	l/s	71008	71008	81152	91296	101440	111584
Refrigerant circuits								
		n	2	2	2	2	2	2
Refrigerant type / GWP								
		-	R1234ze(E) / GWP = 7					
Refrigerant Charge	(11)	kg	120	120	130	141	150	175
Compressor type								
		-	Single Screw					
Capacity control								
		-	Stepless – Variable Frequency Drive					
Oil charge		lt	16	16	16	16	16	16
Casing material								
		-	Galvanized Steel Sheet					
Color								
		-	Ivory White					
Unit length		mm	6909	6909	7809	8709	9602	10510
Unit width		mm	2280	2280	2280	2280	2280	2280
Unit height		mm	2540	2540	2540	2540	2540	2540
Unit weight - shipping		kg	7033	7033	7660	8093	8900	9288
Unit weight - operation		kg	7313	7313	8152	8585	9483	9871
Water connection size		mm	168,3	168,3	219,1	219,1	219,1	219,1
Water connection type								
		-	Victaulic					
<p>(1) Standard Rating Conditions for Air to water chillers according to EN14511:2 Outdoor Heat exchanger inlet dry bulb temperature 35°; Indoor heat exchanger inlet water temperature 12°C, outlet water temperature 7°C. Fouling factor = 0</p> <p>(2) Minimum capacity for the unit operating at Standard Rating Conditions: Operating Ambient Temperature 35°C, Evaporator, water outlet 7°C</p> <p>(3) Seasonal Energy Efficiency Ratio as defined in EN14825, part load condition in cooling for Air to Water units, fan coil application, variable outlet, variable flow.</p> <p>(4) the seasonal space cooling energy efficiency <math>\eta_{s,c}</math> is calculated as defined in Regulation (EU) 2016/2281 the seasonal energy efficiency ratio SEER divided by the conversion coefficient CC (2.5), corrected by contributions accounting for temperature control (0.03).</p> <p>(5) Seasonal energy performance Ratio as defined in Regulation (EU) 2016/2281 for a high temperature process chiller at standard rating conditions defined in EN14511:2</p> <p>(6) minimum flow rate to be reached in variable water flow system (not managed by the unit controller BMS) with unit operating at minimum load.</p> <p>(7) not including filter pressure drop. The installation of the filter is mandatory.</p> <p>(8) sound power level measured in accordance to ISO9614, referred to unit operating at Standard Rating Conditions for Air to water chillers according to EN14511:2 Outdoor Heat exchanger inlet dry bulb temperature 35°; Indoor heat exchanger inlet water temperature 12°C, outlet water temperature 7°C</p> <p>(9) sound power level measured in accordance to ISO3744, referred to unit operating at Standard Rating Conditions for Air to water chillers according to EN14511:2 Outdoor Heat exchanger inlet dry bulb temperature 35°; Indoor heat exchanger inlet water temperature 12°C, outlet water temperature 7°C</p> <p>(10) referred to unit with free discharge on condenser fans.</p> <p>(11) data subject to change. Refer to unit's name plate for actual value.</p>								
<p>Data certified by Eurovent certification scheme</p> <p>The above data are referred to the unit without additional optional.</p> <p>The above data are referred the unit installed in compliancy with installation prescription.</p> <p>All the data are subject to change without notice. For updated information on project base refer to Chiller Selection Software and unit's certified drawing</p>								

EWAH~TZ- SL C – standard unit								
MODEL	notes		C11	C12	C13	C14	C15	C16
Cooling Capacity	(1)	kW	1117	1231	1302	1432	1519	1603
Power Input	(1)	kW	357	396	418	465	510	567
EER	(1)	kW/kW	3,13	3,11	3,11	3,08	2,98	2,83
Minimum capacity	(2)	%	12,5	12,5	12,5	12,5	12,5	12,5
SEER	(3)	kW/kW	4,63	4,56	4,92	4,88	4,84	4,8
$\eta_{s,c}$	(4)	%	182	179	194	192	191	189
SEER + opt99a	(3)	kW/kW	5,26	5,15	5,48	5,47	5,42	5,38
$\eta_{s,c}$ + opt99a	(4)	%	207	203	216	216	214	212
Evaporator type								
		-	Direct Expansion – Shell & Tubes					
Water flow rate	(1)	l/s	53,3	58,7	62,1	68,3	72,4	76,5
Evaporator pressure drop	(1) (7)	kPa	44,3	52,7	38,7	45,9	51,0	56,3
Evaporator water volume	(8)	lt	1043	1043	1011	1011	1011	1011
Minimum water rate	(6)	l/s	18,1	18,1	22,7	22,7	22,7	22,7
Sound Power								
Sound Power	(1) (8)	dB(A)	102	103	102	102	103	104
Sound Pressure @ 1 m	(1) (9)	dB(A)	79	80	79	79	80	80
Sound Power + opt76b	(1) (8)	dB(A)	100	101	100	100	101	101
Sound Pressure @ 1 m + opt76b	(1) (9)	dB(A)	77	78	77	77	78	78
Fan type								
		-	Direct Propeller					
Fan diameter		mm	800					
Fan rotational speed		RPM	900					
Fan motor / control		-	AC – On/Off					
Number of fans		n	24	26	24	26	28	30
Power input fans		kW	42,0	45,5	42,0	45,5	49,0	52,5
Air flow	(10)	l/s	121728	131872	121728	131872	142016	152160
Refrigerant circuits								
		n	2	2	2	2	2	2
Refrigerant type / GWP								
		-	R1234ze(E) / GWP = 7					
Refrigerant Charge	(11)	kg	200	220	200	220	250	270
Compressor type								
		-	Single Screw					
Capacity control								
		-	Stepless – Variable Frequency Drive					
Oil charge		lt	16	16	25	25	25	25
Casing material								
		-	Galvanized Steel Sheet					
Color								
		-	Ivory White					
Unit length		mm	11402	12302	11402	12302	13202	14102
Unit width		mm	2280	2280	2280	2280	2280	2280
Unit height		mm	2540	2540	2540	2540	2540	2540
Unit weight - shipping		kg	10073	10475	10716	11134	11564	12037
Unit weight - operation		kg	11116	11518	11727	12145	12575	13048
Water connection size		mm	273,0	273,0	273,0	273,0	273,0	273,0
Water connection type								
		-	Victaulic					
<p>(1) Standard Rating Conditions for Air to water chillers according to EN14511:2 Outdoor Heat exchanger inlet dry bulb temperature 35°; Indoor heat exchanger inlet water temperature 12°C, outlet water temperature 7°C. Fouling factor = 0</p> <p>(2) Minimum capacity for the unit operating at Standard Rating Conditions: Operating Ambient Temperature 35°C, Evaporator, water outlet 7°C</p> <p>(3) Seasonal Energy Efficiency Ratio as defined in EN14825, part load condition in cooling for Air to Water units, fan coil application, variable outlet, variable flow.</p> <p>(4) the seasonal space cooling energy efficiency <math>\eta_{s,c}</math> is calculated as defined in Regulation (EU) 2016/2281 the seasonal energy efficiency ratio SEER divided by the conversion coefficient CC (2.5), corrected by contributions accounting for temperature control (0.03).</p> <p>(5) Seasonal energy performance Ratio as defined in Regulation (EU) 2016/2281 for a high temperature process chiller at standard rating conditions defined in EN14511:2</p> <p>(6) minimum flow rate to be reached in variable water flow system (not managed by the unit controller BMS) with unit operating at minimum load.</p> <p>(7) not including filter pressure drop. The installation of the filter is mandatory.</p> <p>(8) sound power level measured in accordance to ISO9614, referred to unit operating at Standard Rating Conditions for Air to water chillers according to EN14511:2 Outdoor Heat exchanger inlet dry bulb temperature 35°; Indoor heat exchanger inlet water temperature 12°C, outlet water temperature 7°C</p> <p>(9) sound power level measured in accordance to ISO3744, referred to unit operating at Standard Rating Conditions for Air to water chillers according to EN14511:2 Outdoor Heat exchanger inlet dry bulb temperature 35°; Indoor heat exchanger inlet water temperature 12°C, outlet water temperature 7°C</p> <p>(10) referred to unit with free discharge on condenser fans.</p> <p>(11) data subject to change. Refer to unit's name plate for actual value.</p>								
<p>■ Data certified by Eurovent certification scheme</p> <p>The above data are referred to the unit without additional optional.</p> <p>The above data are referred the unit installed in compliancy with installation prescription.</p> <p>All the data are subject to change without notice. For updated information on project base refer to Chiller Selection Software and unit's certified drawing</p>								

EWAH~TZ- SR C – standard unit								
MODEL	notes		710	770	880	940	990	H10
Cooling Capacity	(1)	kW	696,3	749,2	859,6	922,1	970,5	1034
Power Input	(1)	kW	232	253	291	309	319	340
EER	(1)	kW/kW	3,00	2,96	2,96	2,98	3,04	3,04
Minimum capacity	(2)	%	12,5	12,5	12,5	12,5	12,5	12,5
SEER	(3)	kW/kW	5,19	5,14	5,14	5,18	5,32	5,26
$\eta_{s,c}$	(4)	%	205	203	203	204	210	207
Evaporator type								
		-	Direct Expansion – Shell & Tubes					
Water flow rate	(1)	l/s	33,2	35,7	41,0	44,0	46,3	49,3
Evaporator pressure drop	(1) (7)	kPa	42,8	48,9	57,3	65,0	57,8	64,8
Evaporator water volume	(8)	lt	280	280	492	492	583	583
Minimum water rate	(6)	l/s	12,9	12,9	12,3	12,3	14,6	14,6
Sound Power								
	(1) (8)	dB(A)	91	91	92	93	94	94
Sound Pressure @ 1 m								
	(1) (9)	dB(A)	70	70	70	71	72	72
Fan type								
		-	Direct Propeller					
Fan diameter								
		mm	800					
Fan rotational speed								
		RPM	700					
Fan motor / control								
		-	AC – VFD					
Number of fans								
		n	14	14	16	18	20	22
Power input fans								
		kW	11,2	11,2	12,8	14,4	16,0	17,6
Air flow								
	(10)	l/s	53667	53667	61333	69000	76667	84333
Refrigerant circuits								
		n	2	2	2	2	2	2
Refrigerant type / GWP								
		-	R1234ze(E) / GWP = 7					
Refrigerant Charge								
	(11)	kg	120	120	130	141	150	175
Compressor type								
		-	Single Screw					
Capacity control								
		-	Stepless – Variable Frequency Drive					
Oil charge								
		lt	16	16	16	16	16	16
Casing material								
		-	Galvanized Steel Sheet					
Color								
		-	Ivory White					
Unit length								
		mm	6909	6909	7809	8709	9602	10510
Unit width								
		mm	2280	2280	2280	2280	2280	2280
Unit height								
		mm	2540	2540	2540	2540	2540	2540
Unit weight - shipping								
		kg	7033	7033	7660	8093	8900	9288
Unit weight - operation								
		kg	7313	7313	8152	8585	9483	9871
Water connection size								
		mm	168,3	168,3	219,1	219,1	219,1	219,1
Water connection type								
		-	Victaulic					
<p>(1) Standard Rating Conditions for Air to water chillers according to EN14511:2 Outdoor Heat exchanger inlet dry bulb temperature 35°; Indoor heat exchanger inlet water temperature 12°C, outlet water temperature 7°C. Fouling factor = 0</p> <p>(2) Minimum capacity for the unit operating at Standard Rating Conditions: Operating Ambient Temperature 35°C, Evaporator, water outlet 7°C</p> <p>(3) Seasonal Energy Efficiency Ratio as defined in EN14825, part load condition in cooling for Air to Water units, fan coil application, variable outlet, variable flow.</p> <p>(4) the seasonal space cooling energy efficiency <math>\eta_{s,c}</math> is calculated as defined in Regulation (EU) 2016/2281 the seasonal energy efficiency ratio SEER divided by the conversion coefficient CC (2.5), corrected by contributions accounting for temperature control (0.03).</p> <p>(5) Seasonal energy performance Ratio as defined in Regulation (EU) 2016/2281 for a high temperature process chiller at standard rating conditions defined in EN14511:2</p> <p>(6) minimum flow rate to be reached in variable water flow system (not managed by the unit controller BMS) with unit operating at minimum load.</p> <p>(7) not including filter pressure drop. The installation of the filter is mandatory.</p> <p>(8) sound power level measured in accordance to ISO9614, referred to unit operating at Standard Rating Conditions for Air to water chillers according to EN14511:2 Outdoor Heat exchanger inlet dry bulb temperature 35°; Indoor heat exchanger inlet water temperature 12°C, outlet water temperature 7°C</p> <p>(9) sound power level measured in accordance to ISO3744, referred to unit operating at Standard Rating Conditions for Air to water chillers according to EN14511:2 Outdoor Heat exchanger inlet dry bulb temperature 35°; Indoor heat exchanger inlet water temperature 12°C, outlet water temperature 7°C</p> <p>(10) referred to unit with free discharge on condenser fans.</p> <p>(11) data subject to change. Refer to unit's name plate for actual value.</p>								
<p>Data certified by Eurovent certification scheme</p> <p>The above data are referred to the unit without additional optional.</p> <p>The above data are referred the unit installed in compliancy with installation prescription.</p> <p>All the data are subject to change without notice. For updated information on project base refer to Chiller Selection Software and unit's certified drawing</p>								

EWAH~TZ- SR C – standard unit								
MODEL	notes		C11	C12	C13	C14	C15	C16
Cooling Capacity	(1)	kW	1095	1204	1273	1400	1484	1552
Power Input	(1)	kW	354	396	424	480	525	581
EER	(1)	kW/kW	3,09	3,04	3,00	2,92	2,83	2,67
Minimum capacity	(2)	%	12,5	12,5	12,5	12,5	12,5	12,5
SEER	(3)	kW/kW	5,33	5,25	5,49	5,42	5,42	5,40
$\eta_{s,c}$	(4)	%	210	207	217	214	214	213
Evaporator type								
		-	Direct Expansion – Shell & Tubes					
Water flow rate	(1)	l/s	52,2	57,4	60,7	66,7	70,8	74,0
Evaporator pressure drop	(1) (7)	kPa	42,7	50,7	37,2	44,1	49,0	53,1
Evaporator water volume	(8)	lt	1043	1043	1011	1011	1011	1011
Minimum water rate	(6)	l/s	18,1	18,1	22,7	22,7	22,7	22,7
Sound Power								
	(1) (8)	dB(A)	95	96	95	95	96	97
Sound Pressure @ 1 m								
	(1) (9)	dB(A)	72	73	72	73	73	74
Fan type								
		-	Direct Propeller					
Fan diameter		mm	800					
Fan rotational speed		RPM	700					
Fan motor / control		-	AC – VFD					
Number of fans		n	24	26	24	26	28	30
Power input fans		kW	19,2	20,8	19,2	20,8	22,4	24
Air flow	(10)	l/s	92000	99667	92000	99667	107333	115000
Refrigerant circuits								
		n	2	2	2	2	2	2
Refrigerant type / GWP								
		-	R1234ze(E) / GWP = 7					
Refrigerant Charge	(11)	kg	200	220	200	220	250	270
Compressor type								
		-	Single Screw					
Capacity control								
		-	Stepless – Variable Frequency Drive					
Oil charge		lt	16	16	25	25	25	25
Casing material								
		-	Galvanized Steel Sheet					
Color								
		-	Ivory White					
Unit length		mm	11402	12302	11402	12302	13202	14102
Unit width		mm	2280	2280	2280	2280	2280	2280
Unit height		mm	2540	2540	2540	2540	2540	2540
Unit weight - shipping		kg	10073	10475	10716	11134	11564	12037
Unit weight - operation		kg	11116	11518	11727	12145	12575	13048
Water connection size		mm	273,0	273,0	273,0	273,0	273,0	273,0
Water connection type								
		-	Victaulic					
<p>(1) Standard Rating Conditions for Air to water chillers according to EN14511:2 Outdoor Heat exchanger inlet dry bulb temperature 35°; Indoor heat exchanger inlet water temperature 12°C, outlet water temperature 7°C. Fouling factor = 0</p> <p>(2) Minimum capacity for the unit operating at Standard Rating Conditions: Operating Ambient Temperature 35°C, Evaporator, water outlet 7°C</p> <p>(3) Seasonal Energy Efficiency Ratio as defined in EN14825, part load condition in cooling for Air to Water units, fan coil application, variable outlet, variable flow.</p> <p>(4) the seasonal space cooling energy efficiency <math>\eta_{s,c}</math> is calculated as defined in Regulation (EU) 2016/2281 the seasonal energy efficiency ratio SEER divided by the conversion coefficient CC (2.5), corrected by contributions accounting for temperature control (0.03).</p> <p>(5) Seasonal energy performance Ratio as defined in Regulation (EU) 2016/2281 for a high temperature process chiller at standard rating conditions defined in EN14511:2</p> <p>(6) minimum flow rate to be reached in variable water flow system (not managed by the unit controller BMS) with unit operating at minimum load.</p> <p>(7) not including filter pressure drop. The installation of the filter is mandatory.</p> <p>(8) sound power level measured in accordance to ISO9614, referred to unit operating at Standard Rating Conditions for Air to water chillers according to EN14511:2 Outdoor Heat exchanger inlet dry bulb temperature 35°; Indoor heat exchanger inlet water temperature 12°C, outlet water temperature 7°C</p> <p>(9) sound power level measured in accordance to ISO3744, referred to unit operating at Standard Rating Conditions for Air to water chillers according to EN14511:2 Outdoor Heat exchanger inlet dry bulb temperature 35°; Indoor heat exchanger inlet water temperature 12°C, outlet water temperature 7°C</p> <p>(10) referred to unit with free discharge on condenser fans.</p> <p>(11) data subject to change. Refer to unit's name plate for actual value.</p>								
<p>■ Data certified by Eurovent certification scheme</p> <p>The above data are referred to the unit without additional optional.</p> <p>The above data are referred the unit installed in compliancy with installation prescription.</p> <p>All the data are subject to change without notice. For updated information on project base refer to Chiller Selection Software and unit's certified drawing</p>								

EWAH~TZ- XS C – standard unit								
MODEL	notes		670	780	840	950	C10	C11
Cooling Capacity	(1)	kW	669,3	783,4	840,2	947,7	1014	1120
Power Input	(1)	kW	206	242	260	292	311	352
EER	(1)	kW/kW	3,25	3,24	3,23	3,24	3,26	3,18
Minimum capacity	(2)	%	12,5	12,5	12,5	12,5	12,5	12,5
SEER	(3)	kW/kW	5,32	5,36	5,40	5,47	5,49	5,40
$\eta_{s,c}$	(4)	%	210	211	213	216	217	213
Evaporator type								
		-	Direct Expansion – Shell & Tubes					
Water flow rate	(1)	l/s	31,9	37,4	40,1	45,2	48,4	53,4
Evaporator pressure drop	(1) (7)	kPa	39,9	48,5	55,0	55,3	37,2	44,5
Evaporator water volume	(8)	lt	280	492	492	583	1043	1043
Minimum water rate	(6)	l/s	12,9	12,3	12,3	14,6	18,1	18,1
Sound Power								
	(1) (8)	dB(A)	98	99	100	101	103	105
Sound Pressure @ 1 m								
	(1) (9)	dB(A)	76	78	78	79	80	82
Fan type								
		-	Direct Propeller					
Fan diameter								
		mm	800					
Fan rotational speed								
		RPM	700	700	700	700	700	700
Fan motor / control								
		-	AC – VFD					
Number of fans								
		n	14	16	18	22	24	26
Power input fans								
		kW	11,2	12,8	14,4	17,6	19,2	20,8
Air flow								
	(10)	l/s	53667	61333	69000	84333	92000	99667
Refrigerant circuits								
		n	2	2	2	2	2	2
Refrigerant type / GWP								
		-	R1234ze(E) / GWP = 7					
Refrigerant Charge								
	(11)	kg	120	130	141	175	200	220
Compressor type								
		-	Single Screw					
Capacity control								
		-	Stepless – Variable Frequency Drive					
Oil charge								
		lt	16	16	16	16	16	16
Casing material								
		-	Galvanized Steel Sheet					
Color								
		-	Ivory White					
Unit length								
		mm	6909	7809	8709	10510	11402	12302
Unit width								
		mm	2280	2280	2280	2280	2280	2280
Unit height								
		mm	2540	2540	2540	2540	2540	2540
Unit weight - shipping								
		kg	7033	7660	8093	9288	10073	10475
Unit weight - operation								
		kg	7313	8152	8585	9871	11116	11518
Water connection size								
		mm	168,3	219,1	219,1	219,1	273,0	273,0
Water connection type								
		-	Victaulic					
<p>(1) Standard Rating Conditions for Air to water chillers according to EN14511:2 Outdoor Heat exchanger inlet dry bulb temperature 35°; Indoor heat exchanger inlet water temperature 12°C, outlet water temperature 7°C. Fouling factor = 0</p> <p>(2) Minimum capacity for the unit operating at Standard Rating Conditions: Operating Ambient Temperature 35°C, Evaporator, water outlet 7°C</p> <p>(3) Seasonal Energy Efficiency Ratio as defined in EN14825, part load condition in cooling for Air to Water units, fan coil application, variable outlet, variable flow.</p> <p>(4) the seasonal space cooling energy efficiency <math>\eta_{s,c}</math> is calculated as defined in Regulation (EU) 2016/2281 the seasonal energy efficiency ratio SEER divided by the conversion coefficient CC (2.5), corrected by contributions accounting for temperature control (0.03).</p> <p>(5) Seasonal energy performance Ratio as defined in Regulation (EU) 2016/2281 for a high temperature process chiller at standard rating conditions defined in EN14511:2</p> <p>(6) minimum flow rate to be reached in variable water flow system (not managed by the unit controller BMS) with unit operating at minimum load.</p> <p>(7) not including filter pressure drop. The installation of the filter is mandatory.</p> <p>(8) sound power level measured in accordance to ISO9614, referred to unit operating at Standard Rating Conditions for Air to water chillers according to EN14511:2 Outdoor Heat exchanger inlet dry bulb temperature 35°; Indoor heat exchanger inlet water temperature 12°C, outlet water temperature 7°C</p> <p>(9) sound power level measured in accordance to ISO3744, referred to unit operating at Standard Rating Conditions for Air to water chillers according to EN14511:2 Outdoor Heat exchanger inlet dry bulb temperature 35°; Indoor heat exchanger inlet water temperature 12°C, outlet water temperature 7°C</p> <p>(10) referred to unit with free discharge on condenser fans.</p> <p>(11) data subject to change. Refer to unit's name plate for actual value.</p>								
<p>Data certified by Eurovent certification scheme</p> <p>The above data are referred to the unit without additional optional.</p> <p>The above data are referred the unit installed in compliancy with installation prescription.</p> <p>All the data are subject to change without notice. For updated information on project base refer to Chiller Selection Software and unit's certified drawing</p>								



EWAH~TZ- XS C – standard unit						
MODEL	notes		C12	C13	C14	C15
Cooling Capacity	(1)	kW	1237	1347	1443	1527
Power Input	(1)	kW	380	420	461	507
EER	(1)	kW/kW	3,25	3,20	3,13	3,01
Minimum capacity	(2)	%	12,5	12,5	12,5	12,5
SEER	(3)	kW/kW	5,56	5,53	5,51	5,48
$\eta_{s,c}$	(4)	%	219	218	217	216
Evaporator type						
		-	Direct Expansion – Shell & Tubes			
Water flow rate	(1)	l/s	59,0	64,2	68,8	72,8
Evaporator pressure drop	(1) (7)	kPa	35,3	41,1	46,5	51,5
Evaporator water volume	(8)	lt	1011	1011	1011	1011
Minimum water rate	(6)	l/s	22,7	22,7	22,7	22,7
Sound Power						
	(1) (8)	dB(A)	104	105	106	107
Sound Pressure @ 1 m						
	(1) (9)	dB(A)	82	82	83	84
Fan type						
		-	Direct Propeller			
Fan diameter						
		mm	800			
Fan rotational speed						
		RPM	900	900	900	900
Fan motor / control						
		-	AC – VFD			
Number of fans						
		n	24	26	28	30
Power input fans						
		kW	42,0	45,5	49,0	52,5
Air flow						
	(10)	l/s	121728	131872	142016	152160
Refrigerant circuits						
		n	2	2	2	2
Refrigerant type / GWP						
		-	R1234ze(E) / GWP = 7			
Refrigerant Charge						
	(11)	kg	200	220	250	270
Compressor type						
		-	Single Screw			
Capacity control						
		-	Stepless – Variable Frequency Drive			
Oil charge						
		lt	25	25	25	25
Casing material						
		-	Galvanized Steel Sheet			
Color						
		-	Ivory White			
Unit length						
		mm	11402	12302	13202	14102
Unit width						
		mm	2280	2280	2280	2280
Unit height						
		mm	2540	2540	2540	2540
Unit weight - shipping						
		kg	10716	11134	11564	12037
Unit weight - operation						
		kg	11727	12145	12575	13048
Water connection size						
		mm	273,0	273,0	273,0	273,0
Water connection type						
		-	Victaulic			
<p>(1) Standard Rating Conditions for Air to water chillers according to EN14511:2 Outdoor Heat exchanger inlet dry bulb temperature 35°; Indoor heat exchanger inlet water temperature 12°C, outlet water temperature 7°C. Fouling factor = 0</p> <p>(2) Minimum capacity for the unit operating at Standard Rating Conditions: Operating Ambient Temperature 35°C, Evaporator, water outlet 7°C</p> <p>(3) Seasonal Energy Efficiency Ratio as defined in EN14825, part load condition in cooling for Air to Water units, fan coil application, variable outlet, variable flow.</p> <p>(4) the seasonal space cooling energy efficiency <math>\eta_{s,c}</math> is calculated as defined in Regulation (EU) 2016/2281 the seasonal energy efficiency ratio SEER divided by the conversion coefficient CC (2.5), corrected by contributions accounting for temperature control (0.03).</p> <p>(5) Seasonal energy performance Ratio as defined in Regulation (EU) 2016/2281 for a high temperature process chiller at standard rating conditions defined in EN14511:2</p> <p>(6) minimum flow rate to be reached in variable water flow system (not managed by the unit controller BMS) with unit operating at minimum load.</p> <p>(7) not including filter pressure drop. The installation of the filter is mandatory.</p> <p>(8) sound power level measured in accordance to ISO9614, referred to unit operating at Standard Rating Conditions for Air to water chillers according to EN14511:2 Outdoor Heat exchanger inlet dry bulb temperature 35°; Indoor heat exchanger inlet water temperature 12°C, outlet water temperature 7°C</p> <p>(9) sound power level measured in accordance to ISO3744, referred to unit operating at Standard Rating Conditions for Air to water chillers according to EN14511:2 Outdoor Heat exchanger inlet dry bulb temperature 35°; Indoor heat exchanger inlet water temperature 12°C, outlet water temperature 7°C</p> <p>(10) referred to unit with free discharge on condenser fans.</p> <p>(11) data subject to change. Refer to unit's name plate for actual value.</p>						
<p>Data certified by Eurovent certification scheme</p> <p>The above data are referred to the unit without additional optional.</p> <p>The above data are referred the unit installed in compliancy with installation prescription.</p> <p>All the data are subject to change without notice. For updated information on project base refer to Chiller Selection Software and unit's certified drawing</p>						



EWAH~TZ- XL C – standard unit								
MODEL	notes		670	780	840	950	C10	C11
Cooling Capacity	(1)	kW	669,3	783,4	840,2	947,7	1014	1120
Power Input	(1)	kW	206	242	260	292	311	352
EER	(1)	kW/kW	3,25	3,24	3,23	3,24	3,26	3,18
Minimum capacity	(2)	%	12,5	12,5	12,5	12,5	12,5	12,5
SEER	(3)	kW/kW	5,32	5,36	5,40	5,47	5,49	5,40
$\eta_{s,c}$	(4)	%	210	211	213	216	217	213
Evaporator type								
		-	Direct Expansion – Shell & Tubes					
Water flow rate	(1)	l/s	31,9	37,4	40,1	45,2	48,4	53,4
Evaporator pressure drop	(1) (7)	kPa	39,9	48,5	55,0	55,3	37,2	44,5
Evaporator water volume	(8)	lt	280	492	492	583	1043	1043
Minimum water rate	(6)	l/s	12,9	12,3	12,3	14,6	18,1	18,1
Sound Power								
Sound Power	(1) (8)	dB(A)	93	95	95	96	98	99
Sound Pressure @ 1 m	(1) (9)	dB(A)	72	73	73	74	75	76
Sound Power + opt76b	(1) (8)	dB(A)	90	91	92	93	94	95
Sound Pressure @ 1 m + opt76b	(1) (9)	dB(A)	69	70	70	71	71	72
Fan type								
		-	Direct Propeller					
Fan diameter		mm	800					
Fan rotational speed		RPM	700	700	700	700	700	700
Fan motor / control		-	AC – VFD					
Number of fans		n	14	16	18	22	24	26
Power input fans		kW	11,2	12,8	14,4	17,6	19,2	20,8
Air flow	(10)	l/s	53667	61333	69000	84333	92000	99667
Refrigerant circuits								
		n	2	2	2	2	2	2
Refrigerant type / GWP		-	R1234ze(E) / GWP = 7					
Refrigerant Charge	(11)	kg	120	130	141	175	200	220
Compressor type								
		-	Single Screw					
Capacity control		-	Stepless – Variable Frequency Drive					
Oil charge		lt	16	16	16	16	16	16
Casing material		-	Galvanized Steel Sheet					
Color		-	Ivory White					
Unit length		mm	6909	7809	8709	10510	11402	12302
Unit width		mm	2280	2280	2280	2280	2280	2280
Unit height		mm	2540	2540	2540	2540	2540	2540
Unit weight - shipping		kg	7033	7660	8093	9288	10073	10475
Unit weight - operation		kg	7313	8152	8585	9871	11116	11518
Water connection size		mm	168,3	219,1	219,1	219,1	273,0	273,0
Water connection type		-	Victaulic					
<p>(1) Standard Rating Conditions for Air to water chillers according to EN14511:2 Outdoor Heat exchanger inlet dry bulb temperature 35°; Indoor heat exchanger inlet water temperature 12°C, outlet water temperature 7°C. Fouling factor = 0</p> <p>(2) Minimum capacity for the unit operating at Standard Rating Conditions: Operating Ambient Temperature 35°C, Evaporator, water outlet 7°C</p> <p>(3) Seasonal Energy Efficiency Ratio as defined in EN14825, part load condition in cooling for Air to Water units, fan coil application, variable outlet, variable flow.</p> <p>(4) the seasonal space cooling energy efficiency <math>\eta_{s,c}</math> is calculated as defined in Regulation (EU) 2016/2281 the seasonal energy efficiency ratio SEER divided by the conversion coefficient CC (2.5), corrected by contributions accounting for temperature control (0.03).</p> <p>(5) Seasonal energy performance Ratio as defined in Regulation (EU) 2016/2281 for a high temperature process chiller at standard rating conditions defined in EN14511:2</p> <p>(6) minimum flow rate to be reached in variable water flow system (not managed by the unit controller BMS) with unit operating at minimum load.</p> <p>(7) not including filter pressure drop. The installation of the filter is mandatory.</p> <p>(8) sound power level measured in accordance to ISO9614, referred to unit operating at Standard Rating Conditions for Air to water chillers according to EN14511:2 Outdoor Heat exchanger inlet dry bulb temperature 35°; Indoor heat exchanger inlet water temperature 12°C, outlet water temperature 7°C</p> <p>(9) sound power level measured in accordance to ISO3744, referred to unit operating at Standard Rating Conditions for Air to water chillers according to EN14511:2 Outdoor Heat exchanger inlet dry bulb temperature 35°; Indoor heat exchanger inlet water temperature 12°C, outlet water temperature 7°C referred to unit with free discharge on condenser fans.</p> <p>(10) referred to unit with free discharge on condenser fans.</p> <p>(11) data subject to change. Refer to unit's name plate for actual value.</p>								
<p>■ Data certified by Eurovent certification scheme</p> <p>The above data are referred to the unit without additional optional.</p> <p>The above data are referred the unit installed in compliancy with installation prescription.</p> <p>All the data are subject to change without notice. For updated information on project base refer to Chiller Selection Software and unit's certified drawing</p>								

EWAH~TZ- XL C – standard unit						
MODEL	notes		C12	C13	C14	C15
Cooling Capacity	(1)	kW	1237	1347	1443	1527
Power Input	(1)	kW	380	420	461	507
EER	(1)	kW/kW	3,25	3,20	3,13	3,01
Minimum capacity	(2)	%	12,5	12,5	12,5	12,5
SEER	(3)	kW/kW	5,56	5,53	5,51	5,48
$\eta_{s,c}$	(4)	%	219	218	217	216
<b>Evaporator type</b>						
Evaporator type		-	Direct Expansion – Shell & Tubes			
Water flow rate	(1)	l/s	59,0	64,2	68,8	72,8
Evaporator pressure drop	(1) (7)	kPa	35,3	41,1	46,5	51,5
Evaporator water volume	(8)	lt	1011	1011	1011	1011
Minimum water rate	(6)	l/s	22,7	22,7	22,7	22,7
<b>Sound Power</b>						
Sound Power	(1) (8)	dB(A)	101	102	102	103
Sound Pressure @ 1 m	(1) (9)	dB(A)	79	79	79	80
Sound Power + opt76b	(1) (8)	dB(A)	100	100	101	101
Sound Pressure @ 1 m + opt76b	(1) (9)	dB(A)	77	77	78	78
<b>Fan type</b>						
Fan type		-	Direct Propeller			
Fan diameter		mm	800			
Fan rotational speed		RPM	900	900	900	900
Fan motor / control		-	AC – VFD			
Number of fans		n	24	26	28	30
Power input fans		kW	42,0	45,5	49,0	52,5
Air flow	(10)	l/s	121728	131872	142016	152160
<b>Refrigerant circuits</b>						
Refrigerant circuits		n	2	2	2	2
Refrigerant type / GWP		-	R1234ze(E) / GWP = 7			
Refrigerant Charge	(11)	kg	200	220	250	270
<b>Compressor type</b>						
Compressor type		-	Single Screw			
Capacity control		-	Stepless – Variable Frequency Drive			
Oil charge		lt	25	25	25	25
Casing material		-	Galvanized Steel Sheet			
Color		-	Ivory White			
Unit length		mm	11402	12302	13202	14102
Unit width		mm	2280	2280	2280	2280
Unit height		mm	2540	2540	2540	2540
Unit weight - shipping		kg	10716	11134	11564	12037
Unit weight - operation		kg	11727	12145	12575	13048
Water connection size		mm	273,0	273,0	273,0	273,0
Water connection type		-	Victaulic			
<p>(1) Standard Rating Conditions for Air to water chillers according to EN14511:2 Outdoor Heat exchanger inlet dry bulb temperature 35°; Indoor heat exchanger inlet water temperature 12°C, outlet water temperature 7°C. Fouling factor = 0</p> <p>(2) Minimum capacity for the unit operating at Standard Rating Conditions: Operating Ambient Temperature 35°C, Evaporator, water outlet 7°C</p> <p>(3) Seasonal Energy Efficiency Ratio as defined in EN14825, part load condition in cooling for Air to Water units, fan coil application, variable outlet, variable flow.</p> <p>(4) the seasonal space cooling energy efficiency <math>\eta_{s,c}</math> is calculated as defined in Regulation (EU) 2016/2281 the seasonal energy efficiency ratio SEER divided by the conversion coefficient CC (2.5), corrected by contributions accounting for temperature control (0.03).</p> <p>(5) Seasonal energy performance Ratio as defined in Regulation (EU) 2016/2281 for a high temperature process chiller at standard rating conditions defined in EN14511:2</p> <p>(6) minimum flow rate to be reached in variable water flow system (not managed by the unit controller BMS) with unit operating at minimum load.</p> <p>(7) not including filter pressure drop. The installation of the filter is mandatory.</p> <p>(8) sound power level measured in accordance to ISO9614, referred to unit operating at Standard Rating Conditions for Air to water chillers according to EN14511:2 Outdoor Heat exchanger inlet dry bulb temperature 35°; Indoor heat exchanger inlet water temperature 12°C, outlet water temperature 7°C</p> <p>(9) sound power level measured in accordance to ISO3744, referred to unit operating at Standard Rating Conditions for Air to water chillers according to EN14511:2 Outdoor Heat exchanger inlet dry bulb temperature 35°; Indoor heat exchanger inlet water temperature 12°C, outlet water temperature 7°C referred to unit with free discharge on condenser fans.</p> <p>(10) referred to unit with free discharge on condenser fans.</p> <p>(11) data subject to change. Refer to unit's name plate for actual value.</p>						
<p> Data certified by Eurovent certification scheme</p> <p>The above data are referred to the unit without additional optional.</p> <p>The above data are referred the unit installed in compliancy with installation prescription.</p> <p>All the data are subject to change without notice. For updated information on project base refer to Chiller Selection Software and unit's certified drawing</p>						

EWAH~TZ- XR C – standard unit								
MODEL	notes		670	780	840	950	C10	C11
Cooling Capacity	(1)	kW	669,2	783,2	840	947,5	1014	1119
Power Input	(1)	kW	206	243	262	293	311	352
EER	(1)	kW/kW	3,25	3,22	3,21	3,24	3,26	3,18
Minimum capacity	(2)	%	12,5	12,5	12,5	12,5	12,5	12,5
SEER	(3)	kW/kW	5,28	5,36	5,39	5,47	5,48	5,39
$\eta_{s,c}$	(4)	%	208	211	213	216	216	213
Evaporator type								
		-	Direct Expansion – Shell & Tubes					
Water flow rate	(1)	l/s	31,9	37,4	40,1	45,2	48,3	53,4
Evaporator pressure drop	(1) (7)	kPa	39,9	48,4	55,0	55,3	37,2	44,4
Evaporator water volume	(8)	lt	280	492	492	583	1043	1043
Minimum water rate	(6)	l/s	12,9	12,3	12,3	14,6	18,1	18,1
Sound Power								
	(1) (8)	dB(A)	90	91	92	93	94	95
Sound Pressure @ 1 m								
	(1) (9)	dB(A)	69	70	70	71	71	72
Fan type								
		-	Direct Propeller					
Fan diameter								
		mm	800					
Fan rotational speed								
		RPM	700	700	700	700	700	700
Fan motor / control								
		-	AC – VFD					
Number of fans								
		n	14	16	18	22	24	26
Power input fans								
		kW	11,2	12,8	14,4	17,6	19,2	20,8
Air flow								
	(10)	l/s	53667	61333	69000	84333	92000	99667
Refrigerant circuits								
		n	2	2	2	2	2	2
Refrigerant type / GWP								
		-	R1234ze(E) / GWP = 7					
Refrigerant Charge								
	(11)	kg	120	130	141	175	200	220
Compressor type								
		-	Single Screw					
Capacity control								
		-	Stepless – Variable Frequency Drive					
Oil charge								
		lt	16	16	16	16	16	16
Casing material								
		-	Galvanized Steel Sheet					
Color								
		-	Ivory White					
Unit length								
		mm	6909	7809	8709	10510	11402	12302
Unit width								
		mm	2280	2280	2280	2280	2280	2280
Unit height								
		mm	2540	2540	2540	2540	2540	2540
Unit weight - shipping								
		kg	7033	7660	8093	9288	10073	10475
Unit weight - operation								
		kg	7313	8152	8585	9871	11116	11518
Water connection size								
		mm	168,3	219,1	219,1	219,1	273,0	273,0
Water connection type								
		-	Victaulic					
<p>(1) Standard Rating Conditions for Air to water chillers according to EN14511:2 Outdoor Heat exchanger inlet dry bulb temperature 35°; Indoor heat exchanger inlet water temperature 12°C, outlet water temperature 7°C. Fouling factor = 0</p> <p>(2) Minimum capacity for the unit operating at Standard Rating Conditions: Operating Ambient Temperature 35°C, Evaporator, water outlet 7°C</p> <p>(3) Seasonal Energy Efficiency Ratio as defined in EN14825, part load condition in cooling for Air to Water units, fan coil application, variable outlet, variable flow.</p> <p>(4) the seasonal space cooling energy efficiency <math>\eta_{s,c}</math> is calculated as defined in Regulation (EU) 2016/2281 the seasonal energy efficiency ratio SEER divided by the conversion coefficient CC (2.5), corrected by contributions accounting for temperature control (0.03).</p> <p>(5) Seasonal energy performance Ratio as defined in Regulation (EU) 2016/2281 for a high temperature process chiller at standard rating conditions defined in EN14511:2</p> <p>(6) minimum flow rate to be reached in variable water flow system (not managed by the unit controller BMS) with unit operating at minimum load.</p> <p>(7) not including filter pressure drop. The installation of the filter is mandatory.</p> <p>(8) sound power level measured in accordance to ISO9614, referred to unit operating at Standard Rating Conditions for Air to water chillers according to EN14511:2 Outdoor Heat exchanger inlet dry bulb temperature 35°; Indoor heat exchanger inlet water temperature 12°C, outlet water temperature 7°C</p> <p>(9) sound power level measured in accordance to ISO3744, referred to unit operating at Standard Rating Conditions for Air to water chillers according to EN14511:2 Outdoor Heat exchanger inlet dry bulb temperature 35°; Indoor heat exchanger inlet water temperature 12°C, outlet water temperature 7°C</p> <p>(10) referred to unit with free discharge on condenser fans.</p> <p>(11) data subject to change. Refer to unit's name plate for actual value.</p>								
<p>Data certified by Eurovent certification scheme</p> <p>The above data are referred to the unit without additional optional.</p> <p>The above data are referred the unit installed in compliancy with installation prescription.</p> <p>All the data are subject to change without notice. For updated information on project base refer to Chiller Selection Software and unit's certified drawing</p>								

EWAH~TZ- XR C – standard unit						
MODEL	notes		C12	C13	C14	C15
Cooling Capacity	(1)	kW	1213	1321	1416	1497
Power Input	(1)	kW	382	426	467	515
EER	(1)	kW/kW	3,17	3,10	3,03	2,91
Minimum capacity	(2)	%	12,5	12,5	12,5	12,5
SEER	(3)	kW/kW	5,56	5,58	5,55	5,51
$\eta_{s,c}$	(4)	%	219	220	219	217
Evaporator type						
		-	Direct Expansion – Shell & Tubes			
Water flow rate	(1)	l/s	57,8	63,0	67,5	71,4
Evaporator pressure drop	(1) (7)	kPa	34,1	39,7	45,0	49,7
Evaporator water volume	(8)	lt	1011	1011	1011	1011
Minimum water rate	(6)	l/s	22,7	22,7	22,7	22,7
Sound Power						
	(1) (8)	dB(A)	94	95	96	96
Sound Pressure @ 1 m						
	(1) (9)	dB(A)	72	72	72	73
Fan type						
		-	Direct Propeller			
Fan diameter						
		mm	800			
Fan rotational speed						
		RPM	700	700	700	700
Fan motor / control						
		-	AC – VFD			
Number of fans						
		n	24	26	28	30
Power input fans						
		kW	19,2	20,8	22,4	24,0
Air flow						
	(10)	l/s	92000	99667	107333	115000
Refrigerant circuits						
		n	2	2	2	2
Refrigerant type / GWP						
		-	R1234ze(E) / GWP = 7			
Refrigerant Charge						
	(11)	kg	200	220	250	270
Compressor type						
		-	Single Screw			
Capacity control						
		-	Stepless – Variable Frequency Drive			
Oil charge						
		lt	25	25	25	25
Casing material						
		-	Galvanized Steel Sheet			
Color						
		-	Ivory White			
Unit length						
		mm	11402	12302	13202	14102
Unit width						
		mm	2280	2280	2280	2280
Unit height						
		mm	2540	2540	2540	2540
Unit weight - shipping						
		kg	10716	11134	11564	12037
Unit weight - operation						
		kg	11727	12145	12575	13048
Water connection size						
		mm	273,0	273,0	273,0	273,0
Water connection type						
		-	Victaulic			
<p>(1) Standard Rating Conditions for Air to water chillers according to EN14511:2 Outdoor Heat exchanger inlet dry bulb temperature 35°; Indoor heat exchanger inlet water temperature 12°C, outlet water temperature 7°C. Fouling factor = 0</p> <p>(2) Minimum capacity for the unit operating at Standard Rating Conditions: Operating Ambient Temperature 35°C, Evaporator, water outlet 7°C</p> <p>(3) Seasonal Energy Efficiency Ratio as defined in EN14825, part load condition in cooling for Air to Water units, fan coil application, variable outlet, variable flow.</p> <p>(4) the seasonal space cooling energy efficiency <math>\eta_{s,c}</math> is calculated as defined in Regulation (EU) 2016/2281 the seasonal energy efficiency ratio SEER divided by the conversion coefficient CC (2.5), corrected by contributions accounting for temperature control (0.03).</p> <p>(5) Seasonal energy performance Ratio as defined in Regulation (EU) 2016/2281 for a high temperature process chiller at standard rating conditions defined in EN14511:2</p> <p>(6) minimum flow rate to be reached in variable water flow system (not managed by the unit controller BMS) with unit operating at minimum load.</p> <p>(7) not including filter pressure drop. The installation of the filter is mandatory.</p> <p>(8) sound power level measured in accordance to ISO9614, referred to unit operating at Standard Rating Conditions for Air to water chillers according to EN14511:2 Outdoor Heat exchanger inlet dry bulb temperature 35°; Indoor heat exchanger inlet water temperature 12°C, outlet water temperature 7°C</p> <p>(9) sound power level measured in accordance to ISO3744, referred to unit operating at Standard Rating Conditions for Air to water chillers according to EN14511:2 Outdoor Heat exchanger inlet dry bulb temperature 35°; Indoor heat exchanger inlet water temperature 12°C, outlet water temperature 7°C</p> <p>(10) referred to unit with free discharge on condenser fans.</p> <p>(11) data subject to change. Refer to unit's name plate for actual value.</p>						
<p>Data certified by Eurovent certification scheme</p> <p>The above data are referred to the unit without additional optional.</p> <p>The above data are referred the unit installed in compliancy with installation prescription.</p> <p>All the data are subject to change without notice. For updated information on project base refer to Chiller Selection Software and unit's certified drawing</p>						

EWAD~TZ- SS C – standard unit								
MODEL	notes		H11	H12	H13	C15	C16	H17
Cooling Capacity	(1)	kW	1189	1259	1355	1508	1644	1766
Power Input	(1)	kW	381	413	439	485	533	582
EER	(1)	kW/kW	3,12	3,05	3,09	3,11	3,09	3,04
Minimum capacity	(2)	%	12,5	12,5	12,5	12,5	12,5	12,5
SEER	(3)	kW/kW	4,69	4,64	4,65	4,83	4,87	4,86
$\eta_{s,c}$	(4)	%	185	183	183	190	192	191
SEER + opt99a	(3)	kW/kW	5,23	5,15	5,16	5,27	5,31	5,29
$\eta_{s,c} + opt99a$	(4)	%	206	203	203	208	209	209
Evaporator type								
		-	Direct Expansion – Shell & Tubes					
Water flow rate	(1)	l/s	56,7	60,0	64,6	71,9	78,4	84,2
Evaporator pressure drop	(1) (7)	kPa	57,1	63,3	40,5	49,1	57,4	65,2
Evaporator water volume	(8)	lt	557	557	1011	1011	1011	1011
Minimum water rate	(6)	l/s	18,2	18,2	22,6	22,6	22,6	22,6
Sound Power								
	(1) (8)	dB(A)	102	103	104	104	105	105
Sound Pressure @ 1 m	(1) (9)	dB(A)	80	81	82	81	82	82
Fan type								
		-	Direct Propeller					
Fan diameter		mm	800					
Fan rotational speed		RPM	900					
Fan motor / control		-	AC – On/Off					
Number of fans		n	22	22	24	24	26	28
Power input fans		kW	38,5	38,5	42,0	42,0	45,5	49,0
Air flow	(10)	l/s	111584	111584	121728	121728	131872	142016
Refrigerant circuits								
		n	2	2	2	2	2	2
Refrigerant type / GWP		-	R134a / GWP = 1430					
Refrigerant Charge	(11)	kg	175	175	200	200	220	250
Compressor type								
		-	Single Screw					
Capacity control		-	Stepless – Variable Frequency Drive					
Oil charge		lt	16	16	16	25	25	25
Casing material								
		-	Galvanized Steel Sheet					
Color								
		-	Ivory White					
Unit length		mm	10510	10510	11404	11404	12302	13202
Unit width		mm	2280	2280	2280	2280	2280	2280
Unit height		mm	2540	2540	2540	2540	2540	2540
Unit weight - shipping		kg	9322	9322	10112	10716	11134	11564
Unit weight - operation		kg	9879	9879	11123	11727	12145	12575
Water connection size		mm	219,1	219,1	273,0	273,0	273,0	273,0
Water connection type								
		-	Victaulic					
<p>(1) Standard Rating Conditions for Air to water chillers according to EN14511:2 Outdoor Heat exchanger inlet dry bulb temperature 35°; Indoor heat exchanger inlet water temperature 12°C, outlet water temperature 7°C. Fouling factor = 0</p> <p>(2) Minimum capacity for the unit operating at Standard Rating Conditions: Operating Ambient Temperature 35°C, Evaporator, water outlet 7°C</p> <p>(3) Seasonal Energy Efficiency Ratio as defined in EN14825, part load condition in cooling for Air to Water units, fan coil application, variable outlet, variable flow.</p> <p>(4) the seasonal space cooling energy efficiency <math>\eta_{s,c}</math> is calculated as defined in Regulation (EU) 2016/2281 the seasonal energy efficiency ratio SEER divided by the conversion coefficient CC (2.5), corrected by contributions accounting for temperature control (0.03).</p> <p>(5) Seasonal energy performance Ratio as defined in Regulation (EU) 2016/2281 for a high temperature process chiller at standard rating conditions defined in EN14511:2</p> <p>(6) minimum flow rate to be reached in variable water flow system (not managed by the unit controller BMS) with unit operating at minimum load.</p> <p>(7) not including filter pressure drop. The installation of the filter is mandatory.</p> <p>(8) sound power level measured in accordance to ISO9614, referred to unit operating at Standard Rating Conditions for Air to water chillers according to EN14511:2 Outdoor Heat exchanger inlet dry bulb temperature 35°; Indoor heat exchanger inlet water temperature 12°C, outlet water temperature 7°C</p> <p>(9) sound power level measured in accordance to ISO3744, referred to unit operating at Standard Rating Conditions for Air to water chillers according to EN14511:2 Outdoor Heat exchanger inlet dry bulb temperature 35°; Indoor heat exchanger inlet water temperature 12°C, outlet water temperature 7°C</p> <p>(10) referred to unit with free discharge on condenser fans.</p> <p>(11) data subject to change. Refer to unit's name plate for actual value.</p>								
<p>■ Data certified by Eurovent certification scheme</p> <p>The above data are referred to the unit without additional optional.</p> <p>The above data are referred the unit installed in compliancy with installation prescription.</p> <p>All the data are subject to change without notice. For updated information on project base refer to Chiller Selection Software and unit's certified drawing</p>								

EWAD~TZ- SS C – standard unit				
MODEL	notes		H18	H19
Cooling Capacity	(1)	kW	1875	1965
Power Input	(1)	kW	636	709
EER	(1)	kW/kW	2,95	2,77
Minimum capacity	(2)	%	12,5	12,5
SEER	(3)	kW/kW	4,83	4,68
$\eta_{s,c}$	(4)	%	190	184
SEER + opt99a	(3)	kW/kW	5,28	5,23
$\eta_{s,c}$ + opt99a	(4)	%	208	206
Evaporator type				
		-	Direct Expansion – Shell & Tubes	
Water flow rate	(1)	l/s	89,4	93,7
Evaporator pressure drop	(1) (7)	kPa	72,7	79,0
Evaporator water volume	(8)	lt	1011	1011
Minimum water rate	(6)	l/s	22,6	22,6
Sound Power				
	(1) (8)	dB(A)	106	107
Sound Pressure @ 1 m				
	(1) (9)	dB(A)	83	84
Fan type				
		-	Direct Propeller	
Fan diameter		mm	800	
Fan rotational speed		RPM	900	
Fan motor / control		-	AC – On/Off	
Number of fans		n	30	30
Power input fans		kW	52,5	52,5
Air flow	(10)	l/s	152160	152160
Refrigerant circuits				
		n	2	2
Refrigerant type / GWP				
		-	R134a / GWP = 1430	
Refrigerant Charge	(11)	kg	270	270
Compressor type				
		-	Single Screw	
Capacity control				
		-	Stepless – Variable Frequency Drive	
Oil charge		lt	25	25
Casing material				
		-	Galvanized Steel Sheet	
Color				
		-	Ivory White	
Unit length		mm	14102	14102
Unit width		mm	2280	2280
Unit height		mm	2540	2540
Unit weight - shipping		kg	12037	12037
Unit weight - operation		kg	13048	13048
Water connection size		mm	273,0	273,0
Water connection type				
		-	Victaulic	
<p>(1) Standard Rating Conditions for Air to water chillers according to EN14511:2 Outdoor Heat exchanger inlet dry bulb temperature 35°; Indoor heat exchanger inlet water temperature 12°C, outlet water temperature 7°C. Fouling factor = 0</p> <p>(2) Minimum capacity for the unit operating at Standard Rating Conditions: Operating Ambient Temperature 35°C, Evaporator, water outlet 7°C</p> <p>(3) Seasonal Energy Efficiency Ratio as defined in EN14825, part load condition in cooling for Air to Water units, fan coil application, variable outlet, variable flow.</p> <p>(4) the seasonal space cooling energy efficiency <math>\eta_{s,c}</math> is calculated as defined in Regulation (EU) 2016/2281 the seasonal energy efficiency ratio SEER divided by the conversion coefficient CC (2.5), corrected by contributions accounting for temperature control (0.03).</p> <p>(5) Seasonal energy performance Ratio as defined in Regulation (EU) 2016/2281 for a high temperature process chiller at standard rating conditions defined in EN14511:2</p> <p>(6) minimum flow rate to be reached in variable water flow system (not managed by the unit controller BMS) with unit operating at minimum load.</p> <p>(7) not including filter pressure drop. The installation of the filter is mandatory.</p> <p>(8) sound power level measured in accordance to ISO9614, referred to unit operating at Standard Rating Conditions for Air to water chillers according to EN14511:2 Outdoor Heat exchanger inlet dry bulb temperature 35°; Indoor heat exchanger inlet water temperature 12°C, outlet water temperature 7°C</p> <p>(9) sound power level measured in accordance to ISO3744, referred to unit operating at Standard Rating Conditions for Air to water chillers according to EN14511:2 Outdoor Heat exchanger inlet dry bulb temperature 35°; Indoor heat exchanger inlet water temperature 12°C, outlet water temperature 7°C</p> <p>(10) referred to unit with free discharge on condenser fans.</p> <p>(11) data subject to change. Refer to unit's name plate for actual value.</p>				
<p>Data certified by Eurovent certification scheme  The above data are referred to the unit without additional optional.  The above data are referred the unit installed in compliancy with installation prescription.  All the data are subject to change without notice. For updated information on project base refer to Chiller Selection Software and unit's certified drawing</p>				

EWAD~TZ- SL C – standard unit								
MODEL	notes		H11	H12	H13	C15	C16	H17
Cooling Capacity	(1)	kW	1189	1259	1355	1508	1644	1766
Power Input	(1)	kW	381	413	439	485	533	582
EER	(1)	kW/kW	3,12	3,05	3,09	3,11	3,09	3,04
Minimum capacity	(2)	%	12,5	12,5	12,5	12,5	12,5	12,5
SEER	(3)	kW/kW	4,69	4,64	4,65	4,83	4,87	4,86
$\eta_{s,c}$	(4)	%	185	183	183	190	192	191
SEER + opt99a	(3)	kW/kW	5,23	5,15	5,16	5,27	5,31	5,29
$\eta_{s,c}$ + opt99a	(4)	%	206	203	203	208	209	209
Evaporator type								
		-	Direct Expansion – Shell & Tubes					
Water flow rate	(1)	l/s	56,7	60,0	64,6	71,9	78,4	84,2
Evaporator pressure drop	(1) (7)	kPa	57,1	63,3	40,5	49,1	57,4	65,2
Evaporator water volume	(8)	lt	557	557	1011	1011	1011	1011
Minimum water rate	(6)	l/s	18,2	18,2	22,6	22,6	22,6	22,6
Sound Power								
	(1) (8)	dB(A)	100	100	101	101	101	102
Sound Pressure @ 1 m	(1) (9)	dB(A)	77	78	78	78	79	79
Sound Power + opt76b	(1) (8)	dB(A)	99	99	100	100	100	100
Sound Pressure @ 1 m + opt76b	(1) (9)	dB(A)	77	77	77	77	77	77
Fan type								
		-	Direct Propeller					
Fan diameter		mm	800					
Fan rotational speed		RPM	900					
Fan motor / control								
		-	AC – On/Off					
Number of fans		n	22	22	24	24	26	28
Power input fans		kW	38,5	38,5	42,0	42,0	45,5	49,0
Air flow	(10)	l/s	111584	111584	121728	121728	131872	142016
Refrigerant circuits								
		n	2	2	2	2	2	2
Refrigerant type / GWP								
		-	R134a / GWP = 1430					
Refrigerant Charge	(11)	kg	175	175	200	200	220	250
Compressor type								
		-	Single Screw					
Capacity control								
		-	Stepless – Variable Frequency Drive					
Oil charge		lt	16	16	16	25	25	25
Casing material								
		-	Galvanized Steel Sheet					
Color								
		-	Ivory White					
Unit length		mm	10510	10510	11404	11404	12302	13202
Unit width		mm	2280	2280	2280	2280	2280	2280
Unit height		mm	2540	2540	2540	2540	2540	2540
Unit weight - shipping		kg	9322	9322	10112	10716	11134	11564
Unit weight - operation		kg	9879	9879	11123	11727	12145	12575
Water connection size		mm	219,1	219,1	273,0	273,0	273,0	273,0
Water connection type								
		-	Victaulic					
<p>(1) Standard Rating Conditions for Air to water chillers according to EN14511:2 Outdoor Heat exchanger inlet dry bulb temperature 35°; Indoor heat exchanger inlet water temperature 12°C, outlet water temperature 7°C. Fouling factor = 0</p> <p>(2) Minimum capacity for the unit operating at Standard Rating Conditions: Operating Ambient Temperature 35°C, Evaporator, water outlet 7°C</p> <p>(3) Seasonal Energy Efficiency Ratio as defined in EN14825, part load condition in cooling for Air to Water units, fan coil application, variable outlet, variable flow.</p> <p>(4) the seasonal space cooling energy efficiency <math>\eta_{s,c}</math> is calculated as defined in Regulation (EU) 2016/2281 the seasonal energy efficiency ratio SEER divided by the conversion coefficient CC (2.5), corrected by contributions accounting for temperature control (0.03).</p> <p>(5) Seasonal energy performance Ratio as defined in Regulation (EU) 2016/2281 for a high temperature process chiller at standard rating conditions defined in EN14511:2</p> <p>(6) minimum flow rate to be reached in variable water flow system (not managed by the unit controller BMS) with unit operating at minimum load.</p> <p>(7) not including filter pressure drop. The installation of the filter is mandatory.</p> <p>(8) sound power level measured in accordance to ISO9614, referred to unit operating at Standard Rating Conditions for Air to water chillers according to EN14511:2 Outdoor Heat exchanger inlet dry bulb temperature 35°; Indoor heat exchanger inlet water temperature 12°C, outlet water temperature 7°C</p> <p>(9) sound power level measured in accordance to ISO3744, referred to unit operating at Standard Rating Conditions for Air to water chillers according to EN14511:2 Outdoor Heat exchanger inlet dry bulb temperature 35°; Indoor heat exchanger inlet water temperature 12°C, outlet water temperature 7°C</p> <p>(10) referred to unit with free discharge on condenser fans.</p> <p>(11) data subject to change. Refer to unit's name plate for actual value.</p>								
<p>Data certified by Eurovent certification scheme</p> <p>The above data are referred to the unit without additional optional.</p> <p>The above data are referred the unit installed in compliancy with installation prescription.</p> <p>All the data are subject to change without notice. For updated information on project base refer to Chiller Selection Software and unit's certified drawing</p>								



EWAD~TZ- SL C – standard unit				
MODEL	notes		H18	H19
Cooling Capacity	(1)	kW	1875	1965
Power Input	(1)	kW	636	709
EER	(1)	kW/kW	2,95	2,77
Minimum capacity	(2)	%	12,5	12,5
SEER	(3)	kW/kW	4,83	4,68
$\eta_{s,c}$	(4)	%	190	184
SEER + opt99a	(3)	kW/kW	5,28	5,23
$\eta_{s,c}$ + opt99a	(4)	%	208	206
<b>Evaporator type</b>				
Evaporator type		-	Direct Expansion – Shell & Tubes	
Water flow rate	(1)	l/s	89,4	93,7
Evaporator pressure drop	(1) (7)	kPa	72,7	79,0
Evaporator water volume	(8)	lt	1011	1011
Minimum water rate	(6)	l/s	22,6	22,6
<b>Sound Power</b>				
Sound Power	(1) (8)	dB(A)	103	103
Sound Pressure @ 1 m	(1) (9)	dB(A)	79	80
Sound Power + opt76b	(1) (8)	dB(A)	101	101
Sound Pressure @ 1 m + opt76b	(1) (9)	dB(A)	78	78
<b>Fan type</b>				
Fan type		-	Direct Propeller	
Fan diameter		mm	800	
Fan rotational speed		RPM	900	
Fan motor / control		-	AC – On/Off	
Number of fans		n	30	30
Power input fans		kW	52,5	52,5
Air flow	(10)	l/s	152160	152160
<b>Refrigerant circuits</b>				
Refrigerant circuits		n	2	2
Refrigerant type / GWP		-	R134a / GWP = 1430	
Refrigerant Charge	(11)	kg	270	270
<b>Compressor type</b>				
Compressor type		-	Single Screw	
Capacity control		-	Stepless – Variable Frequency Drive	
Oil charge		lt	25	25
Casing material		-	Galvanized Steel Sheet	
Color		-	Ivory White	
Unit length		mm	14102	14102
Unit width		mm	2280	2280
Unit height		mm	2540	2540
Unit weight - shipping		kg	12037	12037
Unit weight - operation		kg	13048	13048
Water connection size		mm	273,0	273,0
Water connection type		-	Victaulic	
<p>(1) Standard Rating Conditions for Air to water chillers according to EN14511:2 Outdoor Heat exchanger inlet dry bulb temperature 35°; Indoor heat exchanger inlet water temperature 12°C, outlet water temperature 7°C. Fouling factor = 0</p> <p>(2) Minimum capacity for the unit operating at Standard Rating Conditions: Operating Ambient Temperature 35°C, Evaporator, water outlet 7°C</p> <p>(3) Seasonal Energy Efficiency Ratio as defined in EN14825, part load condition in cooling for Air to Water units, fan coil application, variable outlet, variable flow.</p> <p>(4) the seasonal space cooling energy efficiency <math>\eta_{s,c}</math> is calculated as defined in Regulation (EU) 2016/2281 the seasonal energy efficiency ratio SEER divided by the conversion coefficient CC (2.5), corrected by contributions accounting for temperature control (0.03).</p> <p>(5) Seasonal energy performance Ratio as defined in Regulation (EU) 2016/2281 for a high temperature process chiller at standard rating conditions defined in EN14511:2</p> <p>(6) minimum flow rate to be reached in variable water flow system (not managed by the unit controller BMS) with unit operating at minimum load.</p> <p>(7) not including filter pressure drop. The installation of the filter is mandatory.</p> <p>(8) sound power level measured in accordance to ISO9614, referred to unit operating at Standard Rating Conditions for Air to water chillers according to EN14511:2 Outdoor Heat exchanger inlet dry bulb temperature 35°; Indoor heat exchanger inlet water temperature 12°C, outlet water temperature 7°C</p> <p>(9) sound power level measured in accordance to ISO3744, referred to unit operating at Standard Rating Conditions for Air to water chillers according to EN14511:2 Outdoor Heat exchanger inlet dry bulb temperature 35°; Indoor heat exchanger inlet water temperature 12°C, outlet water temperature 7°C</p> <p>(10) referred to unit with free discharge on condenser fans.</p> <p>(11) data subject to change. Refer to unit's name plate for actual value.</p>				
<p> Data certified by Eurovent certification scheme</p> <p>The above data are referred to the unit without additional optional.</p> <p>The above data are referred the unit installed in compliancy with installation prescription.</p> <p>All the data are subject to change without notice. For updated information on project base refer to Chiller Selection Software and unit's certified drawing</p>				

EWAD~TZ- SR C – standard unit								
MODEL	notes		H11	H12	H13	C15	C16	H17
Cooling Capacity	(1)	kW	1164	1229	1323	1463	1595	1712
Power Input	(1)	kW	385	423	446	514	565	611
EER	(1)	kW/kW	3,03	2,91	2,97	2,85	2,83	2,80
Minimum capacity	(2)	%	12,5	12,5	12,5	12,5	12,5	12,5
SEER	(3)	kW/kW	5,24	5,12	5,15	5,18	5,21	5,20
$\eta_{s,c}$	(4)	%	207	202	203	204	205	205
Evaporator type								
		-	Direct Expansion – Shell & Tubes					
Water flow rate	(1)	l/s	55,5	58,6	63,1	69,7	76,1	81,6
Evaporator pressure drop	(1) (7)	kPa	55,0	60,6	38,8	46,5	54,3	61,6
Evaporator water volume	(8)	lt	557	557	1011	1011	1011	1011
Minimum water rate	(6)	l/s	18,2	18,2	22,6	22,6	22,6	22,6
Sound Power								
	(1) (8)	dB(A)	93	93	94	94	94	95
Sound Pressure @ 1 m								
	(1) (9)	dB(A)	70	71	71	71	71	72
Fan type								
		-	Direct Propeller					
Fan diameter		mm	800					
Fan rotational speed		RPM	700					
Fan motor / control		-	AC – VFD					
Number of fans		n	22	22	24	24	26	28
Power input fans		kW	17,6	17,6	19,2	19,2	20,8	22,4
Air flow	(10)	l/s	84333	84333	92000	92000	99667	107333
Refrigerant circuits								
		n	2	2	2	2	2	2
Refrigerant type / GWP								
		-	R134a / GWP = 1430					
Refrigerant Charge								
	(11)	kg	175	175	200	200	220	250
Compressor type								
		-	Single Screw					
Capacity control								
		-	Stepless – Variable Frequency Drive					
Oil charge								
		lt	16	16	16	25	25	25
Casing material								
		-	Galvanized Steel Sheet					
Color								
		-	Ivory White					
Unit length		mm	10510	10510	11404	11404	12302	13202
Unit width		mm	2280	2280	2280	2280	2280	2280
Unit height		mm	2540	2540	2540	2540	2540	2540
Unit weight - shipping		kg	9322	9322	10112	10716	11134	11564
Unit weight - operation		kg	9879	9879	11123	11727	12145	12575
Water connection size								
		mm	219,1	219,1	273,0	273,0	273,0	273,0
Water connection type								
		-	Victaulic					
<p>(1) Standard Rating Conditions for Air to water chillers according to EN14511:2 Outdoor Heat exchanger inlet dry bulb temperature 35°; Indoor heat exchanger inlet water temperature 12°C, outlet water temperature 7°C. Fouling factor = 0</p> <p>(2) Minimum capacity for the unit operating at Standard Rating Conditions: Operating Ambient Temperature 35°C, Evaporator, water outlet 7°C</p> <p>(3) Seasonal Energy Efficiency Ratio as defined in EN14825, part load condition in cooling for Air to Water units, fan coil application, variable outlet, variable flow.</p> <p>(4) the seasonal space cooling energy efficiency <math>\eta_{s,c}</math> is calculated as defined in Regulation (EU) 2016/2281 the seasonal energy efficiency ratio SEER divided by the conversion coefficient CC (2.5), corrected by contributions accounting for temperature control (0.03).</p> <p>(5) Seasonal energy performance Ratio as defined in Regulation (EU) 2016/2281 for a high temperature process chiller at standard rating conditions defined in EN14511:2</p> <p>(6) minimum flow rate to be reached in variable water flow system (not managed by the unit controller BMS) with unit operating at minimum load.</p> <p>(7) not including filter pressure drop. The installation of the filter is mandatory.</p> <p>(8) sound power level measured in accordance to ISO9614, referred to unit operating at Standard Rating Conditions for Air to water chillers according to EN14511:2 Outdoor Heat exchanger inlet dry bulb temperature 35°; Indoor heat exchanger inlet water temperature 12°C, outlet water temperature 7°C</p> <p>(9) sound power level measured in accordance to ISO3744, referred to unit operating at Standard Rating Conditions for Air to water chillers according to EN14511:2 Outdoor Heat exchanger inlet dry bulb temperature 35°; Indoor heat exchanger inlet water temperature 12°C, outlet water temperature 7°C</p> <p>(10) referred to unit with free discharge on condenser fans.</p> <p>(11) data subject to change. Refer to unit's name plate for actual value.</p>								
<p>Data certified by Eurovent certification scheme</p> <p>The above data are referred to the unit without additional optional.</p> <p>The above data are referred the unit installed in compliancy with installation prescription.</p> <p>All the data are subject to change without notice. For updated information on project base refer to Chiller Selection Software and unit's certified drawing</p>								

EWAD~TZ- SR C – standard unit				
MODEL	notes		H18	H19
Cooling Capacity	(1)	kW	1812	1876
Power Input	(1)	kW	663	741
EER	(1)	kW/kW	2,73	2,53
Minimum capacity	(2)	%	12,5	12,5
SEER	(3)	kW/kW	5,20	5,11
$\eta_{s,c}$	(4)	%	205	201
Evaporator type				
		-	Direct Expansion – Shell & Tubes	
Water flow rate	(1)	l/s	86,4	89,5
Evaporator pressure drop	(1) (7)	kPa	68,3	72,7
Evaporator water volume	(8)	lt	1011	1011
Minimum water rate	(6)	l/s	22,6	22,6
Sound Power				
	(1) (8)	dB(A)	96	96
Sound Pressure @ 1 m	(1) (9)	dB(A)	72	73
Fan type				
		-	Direct Propeller	
Fan diameter		mm	800	
Fan rotational speed		RPM	700	
Fan motor / control		-	AC – VFD	
Number of fans		n	30	30
Power input fans		kW	24,0	24,0
Air flow	(10)	l/s	115000	115000
Refrigerant circuits				
		n	2	2
Refrigerant type / GWP		-	R134a / GWP = 1430	
Refrigerant Charge	(11)	kg	270	270
Compressor type				
		-	Single Screw	
Capacity control		-	Stepless – Variable Frequency Drive	
Oil charge		lt	25	25
Casing material		-	Galvanized Steel Sheet	
Color		-	Ivory White	
Unit length		mm	14102	14102
Unit width		mm	2280	2280
Unit height		mm	2540	2540
Unit weight - shipping		kg	12037	12037
Unit weight - operation		kg	13048	13048
Water connection size		mm	273,0	273,0
Water connection type		-	Victaulic	
<p>(1) Standard Rating Conditions for Air to water chillers according to EN14511:2 Outdoor Heat exchanger inlet dry bulb temperature 35°; Indoor heat exchanger inlet water temperature 12°C, outlet water temperature 7°C. Fouling factor = 0</p> <p>(2) Minimum capacity for the unit operating at Standard Rating Conditions: Operating Ambient Temperature 35°C, Evaporator, water outlet 7°C</p> <p>(3) Seasonal Energy Efficiency Ratio as defined in EN14825, part load condition in cooling for Air to Water units, fan coil application, variable outlet, variable flow.</p> <p>(4) the seasonal space cooling energy efficiency <math>\eta_{s,c}</math> is calculated as defined in Regulation (EU) 2016/2281 the seasonal energy efficiency ratio SEER divided by the conversion coefficient CC (2,5), corrected by contributions accounting for temperature control (0,03).</p> <p>(5) Seasonal energy performance Ratio as defined in Regulation (EU) 2016/2281 for a high temperature process chiller at standard rating conditions defined in EN14511:2</p> <p>(6) minimum flow rate to be reached in variable water flow system (not managed by the unit controller BMS) with unit operating at minimum load.</p> <p>(7) not including filter pressure drop. The installation of the filter is mandatory.</p> <p>(8) sound power level measured in accordance to ISO9614, referred to unit operating at Standard Rating Conditions for Air to water chillers according to EN14511:2 Outdoor Heat exchanger inlet dry bulb temperature 35°; Indoor heat exchanger inlet water temperature 12°C, outlet water temperature 7°C</p> <p>(9) sound power level measured in accordance to ISO3744, referred to unit operating at Standard Rating Conditions for Air to water chillers according to EN14511:2 Outdoor Heat exchanger inlet dry bulb temperature 35°; Indoor heat exchanger inlet water temperature 12°C, outlet water temperature 7°C</p> <p>(10) referred to unit with free discharge on condenser fans.</p> <p>(11) data subject to change. Refer to unit's name plate for actual value.</p>				
<p>Data certified by Eurovent certification scheme  The above data are referred to the unit without additional optional.  The above data are referred the unit installed in compliancy with installation prescription.  All the data are subject to change without notice. For updated information on project base refer to Chiller Selection Software and unit's certified drawing</p>				

EWAD~TZ- XS C – standard unit								
MODEL	notes		C11	C12	H12	C14	C15	H16
Cooling Capacity	(1)	kW	1124	1206	1280	1399	1539	1667
Power Input	(1)	kW	354	376	402	432	479	525
EER	(1)	kW/kW	3,17	3,21	3,19	3,24	3,22	3,18
Minimum capacity	(2)	%	12,5	12,5	12,5	12,5	12,5	12,5
SEER	(3)	kW/kW	5,36	5,35	5,35	5,37	5,39	5,43
$\eta_{s,c}$	(4)	%	211	211	211	212	213	214
Evaporator type								
		-	Direct Expansion – Shell & Tubes					
Water flow rate	(1)	l/s	53,6	57,5	61,1	66,7	73,4	79,5
Evaporator pressure drop	(1) (7)	kPa	51,6	32,8	36,6	42,9	50,9	58,8
Evaporator water volume	(8)	lt	557	1011	1011	1011	1011	1011
Minimum water rate	(6)	l/s	18,2	22,6	22,6	22,6	22,6	22,6
Sound Power								
Sound Power	(1) (8)	dB(A)	95	96	97	101	101	102
Sound Pressure @ 1 m	(1) (9)	dB(A)	73	73	74	78	78	79
Sound Power + opt76b	(1) (8)	dB(A)	92	93	94	100	100	100
Sound Pressure @ 1 m + opt76b	(1) (9)	dB(A)	70	70	71	77	77	77
Fan type								
		-	Direct Propeller					
Fan diameter		mm	800					
Fan rotational speed		RPM	700	700	700	900	900	900
Fan motor / control		-	AC – VFD					
Number of fans		n	22	24	26	24	26	28
Power input fans		kW	17,6	19,2	20,8	42,0	45,5	49,0
Air flow	(10)	l/s	84333	92000	99667	121728	131872	142016
Refrigerant circuits								
		n	2	2	2	2	2	2
Refrigerant type / GWP								
		-	R134a / GWP = 1430					
Refrigerant Charge	(11)	kg	175	200	220	200	220	250
Compressor type								
		-	Single Screw					
Capacity control								
		-	Stepless – Variable Frequency Drive					
Oil charge		lt	16	16	16	25	25	25
Casing material								
		-	Galvanized Steel Sheet					
Color								
		-	Ivory White					
Unit length		mm	10510	11402	12302	11402	12302	13202
Unit width		mm	2280	2280	2280	2280	2280	2280
Unit height		mm	2540	2540	2540	2540	2540	2540
Unit weight - shipping		kg	9322	10112	10515	10716	11134	11564
Unit weight - operation		kg	9879	11123	11526	11727	12145	12575
Water connection size		mm	219,1	273,0	273,0	273,0	273,0	273,0
Water connection type								
		-	Victaulic					
<p>(1) Standard Rating Conditions for Air to water chillers according to EN14511:2 Outdoor Heat exchanger inlet dry bulb temperature 35°; Indoor heat exchanger inlet water temperature 12°C, outlet water temperature 7°C. Fouling factor = 0</p> <p>(2) Minimum capacity for the unit operating at Standard Rating Conditions: Operating Ambient Temperature 35°C, Evaporator, water outlet 7°C</p> <p>(3) Seasonal Energy Efficiency Ratio as defined in EN14825, part load condition in cooling for Air to Water units, fan coil application, variable outlet, variable flow.</p> <p>(4) the seasonal space cooling energy efficiency <math>\eta_{s,c}</math> is calculated as defined in Regulation (EU) 2016/2281 the seasonal energy efficiency ratio SEER divided by the conversion coefficient CC (2.5), corrected by contributions accounting for temperature control (0.03).</p> <p>(5) Seasonal energy performance Ratio as defined in Regulation (EU) 2016/2281 for a high temperature process chiller at standard rating conditions defined in EN14511:2</p> <p>(6) minimum flow rate to be reached in variable water flow system (not managed by the unit controller BMS) with unit operating at minimum load.</p> <p>(7) not including filter pressure drop. The installation of the filter is mandatory.</p> <p>(8) sound power level measured in accordance to ISO9614, referred to unit operating at Standard Rating Conditions for Air to water chillers according to EN14511:2 Outdoor Heat exchanger inlet dry bulb temperature 35°; Indoor heat exchanger inlet water temperature 12°C, outlet water temperature 7°C</p> <p>(9) sound power level measured in accordance to ISO3744, referred to unit operating at Standard Rating Conditions for Air to water chillers according to EN14511:2 Outdoor Heat exchanger inlet dry bulb temperature 35°; Indoor heat exchanger inlet water temperature 12°C, outlet water temperature 7°C referred to unit with free discharge on condenser fans.</p> <p>(10) referred to unit with free discharge on condenser fans.</p> <p>(11) data subject to change. Refer to unit's name plate for actual value.</p>								
<p>Data certified by Eurovent certification scheme</p> <p>The above data are referred to the unit without additional optional.</p> <p>The above data are referred the unit installed in compliance with installation prescription.</p> <p>All the data are subject to change without notice. For updated information on project base refer to Chiller Selection Software and unit's certified drawing</p>								

EWAD~TZ- XS C – standard unit			
MODEL	notes		H17
Cooling Capacity	(1)	kW	1780
Power Input	(1)	kW	575
EER	(1)	kW/kW	3,09
Minimum capacity	(2)	%	12,5
SEER	(3)	kW/kW	5,39
$\eta_{s,c}$	(4)	%	213
Evaporator type			
		-	Direct Expansion – Shell & Tubes
Water flow rate	(1)	l/s	84,9
Evaporator pressure drop	(1) (7)	kPa	66,1
Evaporator water volume	(8)	lt	1011
Minimum water rate	(6)	l/s	22,6
Sound Power			
Sound Power	(1) (8)	dB(A)	102
Sound Pressure @ 1 m	(1) (9)	dB(A)	79
Sound Power +opt76b	(1) (8)	dB(A)	101
Sound Pressure @ 1 m +opt76b	(1) (9)	dB(A)	77
Fan type			
		-	Direct Propeller
Fan diameter		mm	800
Fan rotational speed		RPM	900
Fan motor / control		-	AC – VFD
Number of fans		n	30
Power input fans		kW	52,5
Air flow	(10)	l/s	152160
Refrigerant circuits			
		n	2
Refrigerant type / GWP		-	R134a / GWP = 1430
Refrigerant Charge	(11)	kg	270
Compressor type			
		-	Single Screw
Capacity control		-	Stepless – Variable Frequency Drive
Oil charge		lt	25
Casing material		-	Galvanized Steel Sheet
Color		-	Ivory White
Unit length		mm	14104
Unit width		mm	2280
Unit height		mm	2540
Unit weight - shipping		kg	12037
Unit weight - operation		kg	13048
Water connection size		mm	273,0
Water connection type		-	Victaulic
<p>(1) Standard Rating Conditions for Air to water chillers according to EN14511:2 Outdoor Heat exchanger inlet dry bulb temperature 35°; Indoor heat exchanger inlet water temperature 12°C, outlet water temperature 7°C. Fouling factor = 0</p> <p>(2) Minimum capacity for the unit operating at Standard Rating Conditions: Operating Ambient Temperature 35°C, Evaporator, water outlet 7°C</p> <p>(3) Seasonal Energy Efficiency Ratio as defined in EN14825, part load condition in cooling for Air to Water units, fan coil application, variable outlet, variable flow.</p> <p>(4) the seasonal space cooling energy efficiency <math>\eta_{s,c}</math> is calculated as defined in Regulation (EU) 2016/2281 the seasonal energy efficiency ratio SEER divided by the conversion coefficient CC (2.5), corrected by contributions accounting for temperature control (0.03).</p> <p>(5) Seasonal energy performance Ratio as defined in Regulation (EU) 2016/2281 for a high temperature process chiller at standard rating conditions defined in EN14511:2</p> <p>(6) minimum flow rate to be reached in variable water flow system (not managed by the unit controller BMS) with unit operating at minimum load.</p> <p>(7) not including filter pressure drop. The installation of the filter is mandatory.</p> <p>(8) sound power level measured in accordance to ISO9614, referred to unit operating at Standard Rating Conditions for Air to water chillers according to EN14511:2 Outdoor Heat exchanger inlet dry bulb temperature 35°; Indoor heat exchanger inlet water temperature 12°C, outlet water temperature 7°C</p> <p>(9) sound power level measured in accordance to ISO3744, referred to unit operating at Standard Rating Conditions for Air to water chillers according to EN14511:2 Outdoor Heat exchanger inlet dry bulb temperature 35°; Indoor heat exchanger inlet water temperature 12°C, outlet water temperature 7°C</p> <p>(10) referred to unit with free discharge on condenser fans.</p> <p>(11) data subject to change. Refer to unit's name plate for actual value.</p>			
<p>■ Data certified by Eurovent certification scheme</p> <p>The above data are referred to the unit without additional optional.</p> <p>The above data are referred the unit installed in compliancy with installation prescription.</p> <p>All the data are subject to change without notice. For updated information on project base refer to Chiller Selection Software and unit's certified drawing</p>			

EWAD~TZ- XR C – standard unit								
MODEL	notes		C11	C12	H12	C14	C15	H16
Cooling Capacity	(1)	kW	1122	1204	1279	1362	1499	1625
Power Input	(1)	kW	356	377	403	450	501	548
EER	(1)	kW/kW	3,15	3,19	3,17	3,03	2,99	2,97
Minimum capacity	(2)	%	12,5	12,5	12,5	12,5	12,5	12,5
SEER	(3)	kW/kW	5,30	5,33	5,32	5,27	5,31	5,31
$\eta_{s,c}$	(4)	%	209	210	210	208	209	209
Evaporator type								
		-	Direct Expansion – Shell & Tubes					
Water flow rate	(1)	l/s	53,5	57,4	61,0	64,9	71,5	77,5
Evaporator pressure drop	(1) (7)	kPa	51,4	32,7	36,5	40,8	48,5	56,1
Evaporator water volume	(8)	lt	557	1011	1011	1011	1011	1011
Minimum water rate	(6)	l/s	18,2	22,6	22,6	22,6	22,6	22,6
Sound Power								
	(1) (8)	dB(A)	92	93	94	93	94	95
Sound Pressure @ 1 m	(1) (9)	dB(A)	70	70	71	71	71	71
Fan type								
		-	Direct Propeller					
Fan diameter		mm	800					
Fan rotational speed		RPM	700					
Fan motor / control		-	AC – VFD					
Number of fans		n	22	24	26	24	26	28
Power input fans		kW	17,6	19,2	20,8	19,2	20,8	22,4
Air flow	(10)	l/s	84333	92000	99667	92000	99667	107333
Refrigerant circuits								
		n	2	2	2	2	2	2
Refrigerant type / GWP		-	R134a / GWP = 1430					
Refrigerant Charge	(11)	kg	175	200	220	200	220	250
Compressor type								
		-	Single Screw					
Capacity control		-	Stepless – Variable Frequency Drive					
Oil charge		lt	16	16	16	25	25	25
Casing material		-	Galvanized Steel Sheet					
Color		-	Ivory White					
Unit length		mm	10510	11402	12302	11402	12302	13202
Unit width		mm	2280	2280	2280	2280	2280	2280
Unit height		mm	2540	2540	2540	2540	2540	2540
Unit weight - shipping		kg	9322	10112	10515	10716	11134	11564
Unit weight - operation		kg	9879	11123	11526	11727	12145	12575
Water connection size		mm	219,1	273,0	273,0	273,0	273,0	273,0
Water connection type		-	Victaulic					
<p>(1) Standard Rating Conditions for Air to water chillers according to EN14511:2 Outdoor Heat exchanger inlet dry bulb temperature 35°; Indoor heat exchanger inlet water temperature 12°C, outlet water temperature 7°C. Fouling factor = 0</p> <p>(2) Minimum capacity for the unit operating at Standard Rating Conditions: Operating Ambient Temperature 35°C, Evaporator, water outlet 7°C</p> <p>(3) Seasonal Energy Efficiency Ratio as defined in EN14825, part load condition in cooling for Air to Water units, fan coil application, variable outlet, variable flow.</p> <p>(4) the seasonal space cooling energy efficiency <math>\eta_{s,c}</math> is calculated as defined in Regulation (EU) 2016/2281 the seasonal energy efficiency ratio SEER divided by the conversion coefficient CC (2.5), corrected by contributions accounting for temperature control (0.03).</p> <p>(5) Seasonal energy performance Ratio as defined in Regulation (EU) 2016/2281 for a high temperature process chiller at standard rating conditions defined in EN14511:2</p> <p>(6) minimum flow rate to be reached in variable water flow system (not managed by the unit controller BMS) with unit operating at minimum load.</p> <p>(7) not including filter pressure drop. The installation of the filter is mandatory.</p> <p>(8) sound power level measured in accordance to ISO9614, referred to unit operating at Standard Rating Conditions for Air to water chillers according to EN14511:2 Outdoor Heat exchanger inlet dry bulb temperature 35°; Indoor heat exchanger inlet water temperature 12°C, outlet water temperature 7°C</p> <p>(9) sound power level measured in accordance to ISO3744, referred to unit operating at Standard Rating Conditions for Air to water chillers according to EN14511:2 Outdoor Heat exchanger inlet dry bulb temperature 35°; Indoor heat exchanger inlet water temperature 12°C, outlet water temperature 7°C</p> <p>(10) referred to unit with free discharge on condenser fans.</p> <p>(11) data subject to change. Refer to unit's name plate for actual value.</p>								
<p>Data certified by Eurovent certification scheme</p> <p>The above data are referred to the unit without additional optional.</p> <p>The above data are referred the unit installed in compliance with installation prescription.</p> <p>All the data are subject to change without notice. For updated information on project base refer to Chiller Selection Software and unit's certified drawing</p>								

EWAD~TZ- XR C – standard unit			
MODEL	notes		H17
Cooling Capacity	(1)	kW	1735
Power Input	(1)	kW	599
EER	(1)	kW/kW	2,90
Minimum capacity	(2)	%	12,5
SEER	(3)	kW/kW	5,32
$\eta_{s,c}$	(4)	%	210
Evaporator type			
		-	Direct Expansion – Shell & Tubes
Water flow rate	(1)	l/s	82,7
Evaporator pressure drop	(1) (7)	kPa	63,2
Evaporator water volume	(8)	lt	1011
Minimum water rate	(6)	l/s	22,6
Sound Power			
	(1) (8)	dB(A)	95
Sound Pressure @ 1 m	(1) (9)	dB(A)	72
Fan type			
		-	Direct Propeller
Fan diameter		mm	800
Fan rotational speed		RPM	700
Fan motor / control		-	AC – VFD
Number of fans		n	30
Power input fans		kW	24,0
Air flow	(10)	l/s	115000
Refrigerant circuits			
		n	2
Refrigerant type / GWP		-	R134a / GWP = 1430
Refrigerant Charge	(11)	kg	270
Compressor type			
		-	Single Screw
Capacity control		-	Stepless – Variable Frequency Drive
Oil charge		lt	25
Casing material		-	Galvanized Steel Sheet
Color		-	Ivory White
Unit length		mm	14104
Unit width		mm	2280
Unit height		mm	2540
Unit weight - shipping		kg	12037
Unit weight - operation		kg	13048
Water connection size		mm	273,0
Water connection type		-	Victaulic
<p>(1) Standard Rating Conditions for Air to water chillers according to EN14511:2 Outdoor Heat exchanger inlet dry bulb temperature 35°; Indoor heat exchanger inlet water temperature 12°C, outlet water temperature 7°C. Fouling factor = 0</p> <p>(2) Minimum capacity for the unit operating at Standard Rating Conditions: Operating Ambient Temperature 35°C, Evaporator, water outlet 7°C</p> <p>(3) Seasonal Energy Efficiency Ratio as defined in EN14825, part load condition in cooling for Air to Water units, fan coil application, variable outlet, variable flow.</p> <p>(4) the seasonal space cooling energy efficiency <math>\eta_{s,c}</math> is calculated as defined in Regulation (EU) 2016/2281 the seasonal energy efficiency ratio SEER divided by the conversion coefficient CC (2,5), corrected by contributions accounting for temperature control (0,03).</p> <p>(5) Seasonal energy performance Ratio as defined in Regulation (EU) 2016/2281 for a high temperature process chiller at standard rating conditions defined in EN14511:2</p> <p>(6) minimum flow rate to be reached in variable water flow system (not managed by the unit controller BMS) with unit operating at minimum load.</p> <p>(7) not including filter pressure drop. The installation of the filter is mandatory.</p> <p>(8) sound power level measured in accordance to ISO9614, referred to unit operating at Standard Rating Conditions for Air to water chillers according to EN14511:2 Outdoor Heat exchanger inlet dry bulb temperature 35°; Indoor heat exchanger inlet water temperature 12°C, outlet water temperature 7°C</p> <p>(9) sound power level measured in accordance to ISO3744, referred to unit operating at Standard Rating Conditions for Air to water chillers according to EN14511:2 Outdoor Heat exchanger inlet dry bulb temperature 35°; Indoor heat exchanger inlet water temperature 12°C, outlet water temperature 7°C</p> <p>(10) referred to unit with free discharge on condenser fans.</p> <p>(11) data subject to change. Refer to unit's name plate for actual value.</p> <p> Data certified by Eurovent certification scheme  The above data are referred to the unit without additional optional.  The above data are referred the unit installed in compliancy with installation prescription.  All the data are subject to change without notice. For updated information on project base refer to Chiller Selection Software and unit's certified drawing</p>			



EWAH~TZ- SS C + OPT158 – BRUSHLESS FANS UP TO 900 RPM								
MODEL	notes		710	770	880	940	990	H10
Cooling Capacity	(1)	kW	711,6	764,9	878,6	941,9	989,7	1055
Power Input	(1)	kW	227	243	281	299	314	334
EER	(1)	kW/kW	3,13	3,14	3,13	3,15	3,15	3,16
Minimum capacity	(2)	%	12,5	12,5	12,5	12,5	12,5	12,5
SEER	(3)	kW/kW	5,30	5,33	5,30	5,28	5,37	5,34
$\eta_{s,c}$	(4)	%	209	210	209	208	212	211
Evaporator type								
		-	Direct Expansion – Shell & Tubes					
Water flow rate	(1)	l/s	33,9	36,5	41,9	44,9	47,2	50,3
Evaporator pressure drop	(1) (7)	kPa	44,6	50,7	59,6	67,5	59,8	67,1
Evaporator water volume	(8)	lt	280	280	492	492	583	583
Minimum water rate	(6)	l/s	12,9	12,9	12,3	12,3	14,6	14,6
Sound Power								
	(1) (8)	dB(A)	101	101	102	103	104	105
Sound Pressure @ 1 m								
	(1) (9)	dB(A)	80	80	80	81	82	82
Fan type								
		-	Direct Propeller					
Fan diameter		mm	800					
Fan rotational speed		RPM	900					
Fan motor / control								
		-	EC Brushless Fan					
Number of fans		n	14	14	16	18	20	22
Power input fans		kW	20,2	20,2	23,0	25,9	28,8	31,7
Air flow	(10)	l/s	68056	68056	77778	87500	97222	106944
Refrigerant circuits								
		n	2	2	2	2	2	2
Refrigerant type / GWP								
		-	R1234ze(E) / GWP = 7					
Refrigerant Charge								
	(11)	kg	120	120	130	141	150	175
Compressor type								
		-	Single Screw					
Capacity control								
		-	Stepless – Variable Frequency Drive					
Oil charge								
		lt	16	16	16	16	16	16
Casing material								
		-	Galvanized Steel Sheet					
Color								
		-	Ivory White					
Unit length		mm	6909	6909	7809	8709	9602	10510
Unit width		mm	2280	2280	2280	2280	2280	2280
Unit height		mm	2540	2540	2540	2540	2540	2540
Unit weight - shipping		kg	7033	7033	7660	8093	8900	9288
Unit weight - operation		kg	7313	7313	8152	8585	9483	9871
Water connection size								
		mm	168,3	168,3	219,1	219,1	219,1	219,1
Water connection type								
		-	Victaulic					
<p>(1) Standard Rating Conditions for Air to water chillers according to EN14511:2 Outdoor Heat exchanger inlet dry bulb temperature 35°; Indoor heat exchanger inlet water temperature 12°C, outlet water temperature 7°C. Fouling factor = 0</p> <p>(2) Minimum capacity for the unit operating at Standard Rating Conditions: Operating Ambient Temperature 35°C, Evaporator, water outlet 7°C</p> <p>(3) Seasonal Energy Efficiency Ratio as defined in EN14825, part load condition in cooling for Air to Water units, fan coil application, variable outlet, variable flow.</p> <p>(4) the seasonal space cooling energy efficiency <math>\eta_{s,c}</math> is calculated as defined in Regulation (EU) 2016/2281 the seasonal energy efficiency ratio SEER divided by the conversion coefficient CC (2.5), corrected by contributions accounting for temperature control (0.03).</p> <p>(5) Seasonal energy performance Ratio as defined in Regulation (EU) 2016/2281 for a high temperature process chiller at standard rating conditions defined in EN14511:2</p> <p>(6) minimum flow rate to be reached in variable water flow system (not managed by the unit controller BMS) with unit operating at minimum load.</p> <p>(7) not including filter pressure drop. The installation of the filter is mandatory.</p> <p>(8) sound power level measured in accordance to ISO9614, referred to unit operating at Standard Rating Conditions for Air to water chillers according to EN14511:2 Outdoor Heat exchanger inlet dry bulb temperature 35°; Indoor heat exchanger inlet water temperature 12°C, outlet water temperature 7°C</p> <p>(9) sound power level measured in accordance to ISO3744, referred to unit operating at Standard Rating Conditions for Air to water chillers according to EN14511:2 Outdoor Heat exchanger inlet dry bulb temperature 35°; Indoor heat exchanger inlet water temperature 12°C, outlet water temperature 7°C</p> <p>(10) referred to unit with free discharge on condenser fans.</p> <p>(11) data subject to change. Refer to unit's name plate for actual value.</p>								
<p>■ Data certified by Eurovent certification scheme</p> <p>The above data are referred to the unit without additional optional.</p> <p>The above data are referred the unit installed in compliance with installation prescription.</p> <p>All the data are subject to change without notice. For updated information on project base refer to Chiller Selection Software and unit's certified drawing</p>								

EWAH~TZ- SS C + OPT158 – BRUSHLESS FANS UP TO 900 RPM								
MODEL	notes		C11	C12	C13	C14	C15	C16
Cooling Capacity	(1)	kW	1116	1230	1300	1431	1517	1602
Power Input	(1)	kW	351	389	413	459	503	560
EER	(1)	kW/kW	3,18	3,16	3,15	3,12	3,01	2,86
Minimum capacity	(2)	%	12,5	12,5	12,5	12,5	12,5	12,5
SEER	(3)	kW/kW	5,40	5,32	5,63	5,61	5,61	5,52
$\eta_{s,c}$	(4)	%	213	210	222	221	221	218
Evaporator type								
		-	Direct Expansion – Shell & Tubes					
Water flow rate	(1)	l/s	53,2	58,6	62,0	68,2	72,4	76,4
Evaporator pressure drop	(1) (7)	kPa	44,2	52,6	38,6	45,8	51,0	56,2
Evaporator water volume	(8)	lt	1043	1043	1011	1011	1011	1011
Minimum water rate	(6)	l/s	18,1	18,1	22,7	22,7	22,7	22,7
Sound Power								
	(1) (8)	dB(A)	106	107	105	106	107	108
Sound Pressure @ 1 m								
	(1) (9)	dB(A)	83	84	83	83	84	85
Fan type								
		-	Direct Propeller					
Fan diameter		mm	800					
Fan rotational speed		RPM	900					
Fan motor / control								
		-	EC Brushless Fan					
Number of fans		n	24	26	24	26	28	30
Power input fans		kW	34,6	37,4	34,6	37,4	40,3	43,2
Air flow	(10)	l/s	116667	126389	116667	126389	136111	145833
Refrigerant circuits								
		n	2	2	2	2	2	2
Refrigerant type / GWP								
		-	R1234ze(E) / GWP = 7					
Refrigerant Charge								
	(11)	kg	200	220	200	220	250	270
Compressor type								
		-	Single Screw					
Capacity control								
		-	Stepless – Variable Frequency Drive					
Oil charge								
		lt	16	16	25	25	25	25
Casing material								
		-	Galvanized Steel Sheet					
Color								
		-	Ivory White					
Unit length		mm	11402	12302	11402	12302	13202	14102
Unit width		mm	2280	2280	2280	2280	2280	2280
Unit height		mm	2540	2540	2540	2540	2540	2540
Unit weight - shipping		kg	10073	10475	10716	11134	11564	12037
Unit weight - operation		kg	11116	11518	11727	12145	12575	13048
Water connection size								
		mm	273,0	273,0	273,0	273,0	273,0	273,0
Water connection type								
		-	Victaulic					
<p>(1) Standard Rating Conditions for Air to water chillers according to EN14511:2 Outdoor Heat exchanger inlet dry bulb temperature 35°; Indoor heat exchanger inlet water temperature 12°C, outlet water temperature 7°C. Fouling factor = 0</p> <p>(2) Minimum capacity for the unit operating at Standard Rating Conditions: Operating Ambient Temperature 35°C, Evaporator, water outlet 7°C</p> <p>(3) Seasonal Energy Efficiency Ratio as defined in EN14825, part load condition in cooling for Air to Water units, fan coil application, variable outlet, variable flow.</p> <p>(4) the seasonal space cooling energy efficiency <math>\eta_{s,c}</math> is calculated as defined in Regulation (EU) 2016/2281 the seasonal energy efficiency ratio SEER divided by the conversion coefficient CC (2.5), corrected by contributions accounting for temperature control (0.03).</p> <p>(5) Seasonal energy performance Ratio as defined in Regulation (EU) 2016/2281 for a high temperature process chiller at standard rating conditions defined in EN14511:2</p> <p>(6) minimum flow rate to be reached in variable water flow system (not managed by the unit controller BMS) with unit operating at minimum load.</p> <p>(7) not including filter pressure drop. The installation of the filter is mandatory.</p> <p>(8) sound power level measured in accordance to ISO9614, referred to unit operating at Standard Rating Conditions for Air to water chillers according to EN14511:2 Outdoor Heat exchanger inlet dry bulb temperature 35°; Indoor heat exchanger inlet water temperature 12°C, outlet water temperature 7°C</p> <p>(9) sound power level measured in accordance to ISO3744, referred to unit operating at Standard Rating Conditions for Air to water chillers according to EN14511:2 Outdoor Heat exchanger inlet dry bulb temperature 35°; Indoor heat exchanger inlet water temperature 12°C, outlet water temperature 7°C</p> <p>(10) referred to unit with free discharge on condenser fans.</p> <p>(11) data subject to change. Refer to unit's name plate for actual value.</p>								
<p>■ Data certified by Eurovent certification scheme</p> <p>The above data are referred to the unit without additional optional.</p> <p>The above data are referred the unit installed in compliancy with installation prescription.</p> <p>All the data are subject to change without notice. For updated information on project base refer to Chiller Selection Software and unit's certified drawing</p>								

EWAH~TZ- SL C + OPT158 – BRUSHLESS FANS UP TO 900 RPM								
MODEL	notes		710	770	880	940	990	H10
Cooling Capacity	(1)	kW	711,6	764,9	878,6	941,9	989,7	1055
Power Input	(1)	kW	227	243	281	299	314	334
EER	(1)	kW/kW	3,13	3,14	3,13	3,15	3,15	3,16
Minimum capacity	(2)	%	12,5	12,5	12,5	12,5	12,5	12,5
SEER	(3)	kW/kW	5,30	5,33	5,30	5,28	5,37	5,34
$\eta_{s,c}$	(4)	%	209	210	209	208	212	211
Evaporator type								
		-	Direct Expansion – Shell & Tubes					
Water flow rate	(1)	l/s	33,9	36,5	41,9	44,9	47,2	50,3
Evaporator pressure drop	(1) (7)	kPa	44,6	50,7	59,6	67,5	59,8	67,1
Evaporator water volume	(8)	lt	280	280	492	492	583	583
Minimum water rate	(6)	l/s	12,9	12,9	12,3	12,3	14,6	14,6
Sound Power								
Sound Power	(1) (8)	dB(A)	98	98	99	100	101	101
Sound Pressure @ 1 m	(1) (9)	dB(A)	77	77	77	78	78	79
Sound Power + opt76b	(1) (8)	dB(A)	97	97	98	98	99	99
Sound Pressure @ 1 m + opt76b	(1) (9)	dB(A)	76	76	76	77	77	77
Fan type								
		-	Direct Propeller					
Fan diameter		mm	800					
Fan rotational speed		RPM	900					
Fan motor / control		-	EC Brushless Fan					
Number of fans		n	14	14	16	18	20	22
Power input fans		kW	20,2	20,2	23,0	25,9	28,8	31,7
Air flow	(10)	l/s	68056	68056	77778	87500	97222	106944
Refrigerant circuits								
		n	2	2	2	2	2	2
Refrigerant type / GWP								
		-	R1234ze(E) / GWP = 7					
Refrigerant Charge								
	(11)	kg	120	120	130	141	150	175
Compressor type								
		-	Single Screw					
Capacity control								
		-	Stepless – Variable Frequency Drive					
Oil charge								
		lt	16	16	16	16	16	16
Casing material								
		-	Galvanized Steel Sheet					
Color								
		-	Ivory White					
Unit length		mm	6909	6909	7809	8709	9602	10510
Unit width		mm	2280	2280	2280	2280	2280	2280
Unit height		mm	2540	2540	2540	2540	2540	2540
Unit weight - shipping		kg	7033	7033	7660	8093	8900	9288
Unit weight - operation		kg	7313	7313	8152	8585	9483	9871
Water connection size		mm	168,3	168,3	219,1	219,1	219,1	219,1
Water connection type								
		-	Victaulic					
<p>(1) Standard Rating Conditions for Air to water chillers according to EN14511:2 Outdoor Heat exchanger inlet dry bulb temperature 35°; Indoor heat exchanger inlet water temperature 12°C, outlet water temperature 7°C. Fouling factor = 0</p> <p>(2) Minimum capacity for the unit operating at Standard Rating Conditions: Operating Ambient Temperature 35°C, Evaporator, water outlet 7°C</p> <p>(3) Seasonal Energy Efficiency Ratio as defined in EN14825, part load condition in cooling for Air to Water units, fan coil application, variable outlet, variable flow.</p> <p>(4) the seasonal space cooling energy efficiency <math>\eta_{s,c}</math> is calculated as defined in Regulation (EU) 2016/2281 the seasonal energy efficiency ratio SEER divided by the conversion coefficient CC (2.5), corrected by contributions accounting for temperature control (0.03).</p> <p>(5) Seasonal energy performance Ratio as defined in Regulation (EU) 2016/2281 for a high temperature process chiller at standard rating conditions defined in EN14511:2</p> <p>(6) minimum flow rate to be reached in variable water flow system (not managed by the unit controller BMS) with unit operating at minimum load.</p> <p>(7) not including filter pressure drop. The installation of the filter is mandatory.</p> <p>(8) sound power level measured in accordance to ISO9614, referred to unit operating at Standard Rating Conditions for Air to water chillers according to EN14511:2 Outdoor Heat exchanger inlet dry bulb temperature 35°; Indoor heat exchanger inlet water temperature 12°C, outlet water temperature 7°C</p> <p>(9) sound power level measured in accordance to ISO3744, referred to unit operating at Standard Rating Conditions for Air to water chillers according to EN14511:2 Outdoor Heat exchanger inlet dry bulb temperature 35°; Indoor heat exchanger inlet water temperature 12°C, outlet water temperature 7°C referred to unit with free discharge on condenser fans.</p> <p>(10) referred to unit with free discharge on condenser fans.</p> <p>(11) data subject to change. Refer to unit's name plate for actual value.</p>								
<p>Data certified by Eurovent certification scheme</p> <p>The above data are referred to the unit without additional optional.</p> <p>The above data are referred the unit installed in compliance with installation prescription.</p> <p>All the data are subject to change without notice. For updated information on project base refer to Chiller Selection Software and unit's certified drawing</p>								

EWAH~TZ- SL C + OPT158 – BRUSHLESS FANS UP TO 900 RPM								
MODEL	notes		C11	C12	C13	C14	C15	C16
Cooling Capacity	(1)	kW	1116	1230	1300	1431	1517	1602
Power Input	(1)	kW	351	389	413	459	503	560
EER	(1)	kW/kW	3,18	3,16	3,15	3,12	3,01	2,86
Minimum capacity	(2)	%	12,5	12,5	12,5	12,5	12,5	12,5
SEER	(3)	kW/kW	5,40	5,32	5,63	5,61	5,61	5,30
$\eta_{s,c}$	(4)	%	213	210	222	221	221	218
Evaporator type								
		-	Direct Expansion – Shell & Tubes					
Water flow rate	(1)	l/s	53,2	58,6	62,0	68,2	72,4	76,4
Evaporator pressure drop	(1) (7)	kPa	44,2	52,6	38,6	45,8	51,0	56,2
Evaporator water volume	(8)	lt	1043	1043	1011	1011	1011	1011
Minimum water rate	(6)	l/s	18,1	18,1	22,7	22,7	22,7	22,7
Sound Power								
Sound Power	(1) (8)	dB(A)	102	103	102	102	103	104
Sound Pressure @ 1 m	(1) (9)	dB(A)	79	80	79	79	80	80
Sound Power + opt76b	(1) (8)	dB(A)	100	101	100	100	101	101
Sound Pressure @ 1 m + opt76b	(1) (9)	dB(A)	77	78	77	77	78	78
Fan type								
		-	Direct Propeller					
Fan diameter		mm	800					
Fan rotational speed		RPM	900					
Fan motor / control		-	EC Brushless Fan					
Number of fans		n	24	26	24	26	28	30
Power input fans		kW	34,6	37,4	34,6	37,4	40,3	43,2
Air flow	(10)	l/s	116667	126389	116667	126389	136111	145833
Refrigerant circuits								
		n	2	2	2	2	2	2
Refrigerant type / GWP								
		-	R1234ze(E) / GWP = 7					
Refrigerant Charge								
	(11)	kg	200	220	200	220	250	270
Compressor type								
		-	Single Screw					
Capacity control								
		-	Stepless – Variable Frequency Drive					
Oil charge								
		lt	16	16	25	25	25	25
Casing material								
		-	Galvanized Steel Sheet					
Color								
		-	Ivory White					
Unit length		mm	11402	12302	11402	12302	13202	14102
Unit width		mm	2280	2280	2280	2280	2280	2280
Unit height		mm	2540	2540	2540	2540	2540	2540
Unit weight - shipping		kg	10073	10475	10716	11134	11564	12037
Unit weight - operation		kg	11116	11518	11727	12145	12575	13048
Water connection size		mm	273,0	273,0	273,0	273,0	273,0	273,0
Water connection type								
		-	Victaulic					
<p>(1) Standard Rating Conditions for Air to water chillers according to EN14511:2 Outdoor Heat exchanger inlet dry bulb temperature 35°; Indoor heat exchanger inlet water temperature 12°C, outlet water temperature 7°C. Fouling factor = 0</p> <p>(2) Minimum capacity for the unit operating at Standard Rating Conditions: Operating Ambient Temperature 35°C, Evaporator, water outlet 7°C</p> <p>(3) Seasonal Energy Efficiency Ratio as defined in EN14825, part load condition in cooling for Air to Water units, fan coil application, variable outlet, variable flow.</p> <p>(4) the seasonal space cooling energy efficiency <math>\eta_{s,c}</math> is calculated as defined in Regulation (EU) 2016/2281 the seasonal energy efficiency ratio SEER divided by the conversion coefficient CC (2.5), corrected by contributions accounting for temperature control (0.03).</p> <p>(5) Seasonal energy performance Ratio as defined in Regulation (EU) 2016/2281 for a high temperature process chiller at standard rating conditions defined in EN14511:2</p> <p>(6) minimum flow rate to be reached in variable water flow system (not managed by the unit controller BMS) with unit operating at minimum load.</p> <p>(7) not including filter pressure drop. The installation of the filter is mandatory.</p> <p>(8) sound power level measured in accordance to ISO9614, referred to unit operating at Standard Rating Conditions for Air to water chillers according to EN14511:2 Outdoor Heat exchanger inlet dry bulb temperature 35°; Indoor heat exchanger inlet water temperature 12°C, outlet water temperature 7°C</p> <p>(9) sound power level measured in accordance to ISO3744, referred to unit operating at Standard Rating Conditions for Air to water chillers according to EN14511:2 Outdoor Heat exchanger inlet dry bulb temperature 35°; Indoor heat exchanger inlet water temperature 12°C, outlet water temperature 7°C referred to unit with free discharge on condenser fans.</p> <p>(10) referred to unit with free discharge on condenser fans.</p> <p>(11) data subject to change. Refer to unit's name plate for actual value.</p>								
<p>Data certified by Eurovent certification scheme</p> <p>The above data are referred to the unit without additional optional.</p> <p>The above data are referred the unit installed in compliance with installation prescription.</p> <p>All the data are subject to change without notice. For updated information on project base refer to Chiller Selection Software and unit's certified drawing</p>								

EWAH~TZ- SR C + OPT159 – BRUSHLESS FANS UP TO 700 RPM								
MODEL	notes		710	770	880	940	990	H10
Cooling Capacity	(1)	kW	696,8	749,7	860,2	922,7	971,1	1035
Power Input	(1)	kW	230	251	289	307	316	337
EER	(1)	kW/kW	3,03	2,99	2,98	3,01	3,07	3,07
Minimum capacity	(2)	%	12,5	12,5	12,5	12,5	12,5	12,5
SEER	(3)	kW/kW	5,32	5,25	5,32	5,29	5,53	5,34
$\eta_{s,c}$	(4)	%	210	207	210	209	218	211
Evaporator type								
		-	Direct Expansion – Shell & Tubes					
Water flow rate	(1)	l/s	33,2	35,8	41,0	44,0	46,3	49,4
Evaporator pressure drop	(1) (7)	kPa	42,9	48,9	57,4	65,1	57,8	64,8
Evaporator water volume	(8)	lt	280	280	492	492	583	583
Minimum water rate	(6)	l/s	12,9	12,9	12,3	12,3	14,6	14,6
Sound Power								
	(1) (8)	dB(A)	91	91	92	93	94	94
Sound Pressure @ 1 m								
	(1) (9)	dB(A)	70	70	70	71	72	72
Fan type								
		-	Direct Propeller					
Fan diameter		mm	800					
Fan rotational speed		RPM	700					
Fan motor / control								
		-	EC Brushless Fan					
Number of fans		n	14	14	16	18	20	22
Power input fans		kW	9,8	9,8	11,2	12,6	14	15,4
Air flow	(10)	l/s	51722	51722	59111	66500	73889	81278
Refrigerant circuits								
		n	2	2	2	2	2	2
Refrigerant type / GWP								
		-	R1234ze(E) / GWP = 7					
Refrigerant Charge								
	(11)	kg	120	120	130	141	150	175
Compressor type								
		-	Single Screw					
Capacity control								
		-	Stepless – Variable Frequency Drive					
Oil charge								
		lt	16	16	16	16	16	16
Casing material								
		-	Galvanized Steel Sheet					
Color								
		-	Ivory White					
Unit length		mm	6909	6909	7809	8709	9602	10510
Unit width		mm	2280	2280	2280	2280	2280	2280
Unit height		mm	2540	2540	2540	2540	2540	2540
Unit weight - shipping		kg	7033	7033	7660	8093	8900	9288
Unit weight - operation		kg	7313	7313	8152	8585	9483	9871
Water connection size								
		mm	168,3	168,3	219,1	219,1	219,1	219,1
Water connection type								
		-	Victaulic					
<p>(1) Standard Rating Conditions for Air to water chillers according to EN14511:2 Outdoor Heat exchanger inlet dry bulb temperature 35°; Indoor heat exchanger inlet water temperature 12°C, outlet water temperature 7°C. Fouling factor = 0</p> <p>(2) Minimum capacity for the unit operating at Standard Rating Conditions: Operating Ambient Temperature 35°C, Evaporator, water outlet 7°C</p> <p>(3) Seasonal Energy Efficiency Ratio as defined in EN14825, part load condition in cooling for Air to Water units, fan coil application, variable outlet, variable flow.</p> <p>(4) the seasonal space cooling energy efficiency <math>\eta_{s,c}</math> is calculated as defined in Regulation (EU) 2016/2281 the seasonal energy efficiency ratio SEER divided by the conversion coefficient CC (2.5), corrected by contributions accounting for temperature control (0.03).</p> <p>(5) Seasonal energy performance Ratio as defined in Regulation (EU) 2016/2281 for a high temperature process chiller at standard rating conditions defined in EN14511:2</p> <p>(6) minimum flow rate to be reached in variable water flow system (not managed by the unit controller BMS) with unit operating at minimum load.</p> <p>(7) not including filter pressure drop. The installation of the filter is mandatory.</p> <p>(8) sound power level measured in accordance to ISO9614, referred to unit operating at Standard Rating Conditions for Air to water chillers according to EN14511:2 Outdoor Heat exchanger inlet dry bulb temperature 35°; Indoor heat exchanger inlet water temperature 12°C, outlet water temperature 7°C</p> <p>(9) sound power level measured in accordance to ISO3744, referred to unit operating at Standard Rating Conditions for Air to water chillers according to EN14511:2 Outdoor Heat exchanger inlet dry bulb temperature 35°; Indoor heat exchanger inlet water temperature 12°C, outlet water temperature 7°C</p> <p>(10) referred to unit with free discharge on condenser fans.</p> <p>(11) data subject to change. Refer to unit's name plate for actual value.</p>								
<p>■ Data certified by Eurovent certification scheme</p> <p>The above data are referred to the unit without additional optional.</p> <p>The above data are referred the unit installed in compliancy with installation prescription.</p> <p>All the data are subject to change without notice. For updated information on project base refer to Chiller Selection Software and unit's certified drawing</p>								

EWAH~TZ- SR C + OPT159 – BRUSHLESS FANS UP TO 700 RPM								
MODEL	notes		C11	C12	C13	C14	C15	C16
Cooling Capacity	(1)	kW	1096	1205	1274	1401	1485	1553
Power Input	(1)	kW	351	393	421	476	521	577
EER	(1)	kW/kW	3,12	3,07	3,03	2,94	2,85	2,69
Minimum capacity	(2)	%	12,5	12,5	12,5	12,5	12,5	12,5
SEER	(3)	kW/kW	5,44	5,33	5,49	5,58	5,53	5,56
$\eta_{s,c}$	(4)	%	215	210	217	220	218	219
Evaporator type								
		-	Direct Expansion – Shell & Tubes					
Water flow rate	(1)	l/s	52,3	57,5	60,8	66,8	70,8	74,1
Evaporator pressure drop	(1) (7)	kPa	42,8	50,8	37,2	44,1	49,0	53,1
Evaporator water volume	(8)	lt	1043	1043	1011	1011	1011	1011
Minimum water rate	(6)	l/s	18,1	18,1	22,7	22,7	22,7	22,7
Sound Power								
	(1) (8)	dB(A)	95	96	95	95	96	97
Sound Pressure @ 1 m								
	(1) (9)	dB(A)	72	73	72	73	73	74
Fan type								
		-	Direct Propeller					
Fan diameter		mm	800					
Fan rotational speed		RPM	700					
Fan motor / control								
		-	EC Brushless Fan					
Number of fans		n	24	26	24	26	28	30
Power input fans		kW	16,8	18,2	16,8	18,2	19,6	21
Air flow	(10)	l/s	88667	96056	88667	96056	103444	110833
Refrigerant circuits								
		n	2	2	2	2	2	2
Refrigerant type / GWP								
		-	R1234ze(E) / GWP = 7					
Refrigerant Charge								
	(11)	kg	200	220	200	220	250	270
Compressor type								
		-	Single Screw					
Capacity control								
		-	Stepless – Variable Frequency Drive					
Oil charge								
		lt	16	16	25	25	25	25
Casing material								
		-	Galvanized Steel Sheet					
Color								
		-	Ivory White					
Unit length		mm	11402	12302	11402	12302	13202	14102
Unit width		mm	2280	2280	2280	2280	2280	2280
Unit height		mm	2540	2540	2540	2540	2540	2540
Unit weight - shipping		kg	10073	10475	10716	11134	11564	12037
Unit weight - operation		kg	11116	11518	11727	12145	12575	13048
Water connection size								
		mm	273,0	273,0	273,0	273,0	273,0	273,0
Water connection type								
		-	Victaulic					
<p>(1) Standard Rating Conditions for Air to water chillers according to EN14511:2 Outdoor Heat exchanger inlet dry bulb temperature 35°; Indoor heat exchanger inlet water temperature 12°C, outlet water temperature 7°C. Fouling factor = 0</p> <p>(2) Minimum capacity for the unit operating at Standard Rating Conditions: Operating Ambient Temperature 35°C, Evaporator, water outlet 7°C</p> <p>(3) Seasonal Energy Efficiency Ratio as defined in EN14825, part load condition in cooling for Air to Water units, fan coil application, variable outlet, variable flow.</p> <p>(4) the seasonal space cooling energy efficiency <math>\eta_{s,c}</math> is calculated as defined in Regulation (EU) 2016/2281 the seasonal energy efficiency ratio SEER divided by the conversion coefficient CC (2.5), corrected by contributions accounting for temperature control (0.03).</p> <p>(5) Seasonal energy performance Ratio as defined in Regulation (EU) 2016/2281 for a high temperature process chiller at standard rating conditions defined in EN14511:2</p> <p>(6) minimum flow rate to be reached in variable water flow system (not managed by the unit controller BMS) with unit operating at minimum load.</p> <p>(7) not including filter pressure drop. The installation of the filter is mandatory.</p> <p>(8) sound power level measured in accordance to ISO9614, referred to unit operating at Standard Rating Conditions for Air to water chillers according to EN14511:2 Outdoor Heat exchanger inlet dry bulb temperature 35°; Indoor heat exchanger inlet water temperature 12°C, outlet water temperature 7°C</p> <p>(9) sound power level measured in accordance to ISO3744, referred to unit operating at Standard Rating Conditions for Air to water chillers according to EN14511:2 Outdoor Heat exchanger inlet dry bulb temperature 35°; Indoor heat exchanger inlet water temperature 12°C, outlet water temperature 7°C</p> <p>(10) referred to unit with free discharge on condenser fans.</p> <p>(11) data subject to change. Refer to unit's name plate for actual value.</p>								
<p>■ Data certified by Eurovent certification scheme</p> <p>The above data are referred to the unit without additional optional.</p> <p>The above data are referred the unit installed in compliancy with installation prescription.</p> <p>All the data are subject to change without notice. For updated information on project base refer to Chiller Selection Software and unit's certified drawing</p>								



EWAH~TZ- XS C + OPT159 – BRUSHLESS FANS UP TO 700 RPM								
MODEL	notes		670	780	840	950	C10	C11
Cooling Capacity	(1)	kW	669,7	783,9	840,7	948,2	1015	1120
Power Input	(1)	kW	204	240	258	289	308	348
EER	(1)	kW/kW	3,28	3,27	3,26	3,28	3,30	3,22
Minimum capacity	(2)	%	12,5	12,5	12,5	12,5	12,5	12,5
SEER	(3)	kW/kW	5,42	5,45	5,48	5,55	5,58	5,46
$\eta_{s,c}$	(4)	%	214	215	216	219	220	215,4
Evaporator type								
		-	Direct Expansion – Shell & Tubes					
Water flow rate	(1)	l/s	31,9	37,4	40,1	45,2	48,4	53,4
Evaporator pressure drop	(1) (7)	kPa	39,9	48,5	55,0	55,4	37,2	44,5
Evaporator water volume	(8)	lt	280	492	492	583	1043	1043
Minimum water rate	(6)	l/s	12,9	12,3	12,3	14,6	18,1	18,1
Sound Power								
	(1) (8)	dB(A)	98	99	100	101	103	105
Sound Pressure @ 1 m								
	(1) (9)	dB(A)	76	78	78	79	80	82
Fan type								
		-	Direct Propeller					
Fan diameter								
		mm	800					
Fan rotational speed								
		RPM	700	700	700	700	700	700
Fan motor / control								
		-	EC Brushless Fan					
Number of fans								
		n	14	16	18	22	24	26
Power input fans								
		kW	9,8	11,2	12,6	15,4	16,8	18,2
Air flow								
	(10)	l/s	51722	59111	66500	81278	88667	96056
Refrigerant circuits								
		n	2	2	2	2	2	2
Refrigerant type / GWP								
		-	R1234ze(E) / GWP = 7					
Refrigerant Charge								
	(11)	kg	120	130	141	175	200	220
Compressor type								
		-	Single Screw					
Capacity control								
		-	Stepless – Variable Frequency Drive					
Oil charge								
		lt	16	16	16	16	16	16
Casing material								
		-	Galvanized Steel Sheet					
Color								
		-	Ivory White					
Unit length								
		mm	6909	7809	8709	10510	11402	12302
Unit width								
		mm	2280	2280	2280	2280	2280	2280
Unit height								
		mm	2540	2540	2540	2540	2540	2540
Unit weight - shipping								
		kg	7033	7660	8093	9288	10073	10475
Unit weight - operation								
		kg	7313	8152	8585	9871	11116	11518
Water connection size								
		mm	168,3	219,1	219,1	219,1	273,0	273,0
Water connection type								
		-	Victaulic					
<p>(1) Standard Rating Conditions for Air to water chillers according to EN14511:2 Outdoor Heat exchanger inlet dry bulb temperature 35°; Indoor heat exchanger inlet water temperature 12°C, outlet water temperature 7°C. Fouling factor = 0</p> <p>(2) Minimum capacity for the unit operating at Standard Rating Conditions: Operating Ambient Temperature 35°C, Evaporator, water outlet 7°C</p> <p>(3) Seasonal Energy Efficiency Ratio as defined in EN14825, part load condition in cooling for Air to Water units, fan coil application, variable outlet, variable flow.</p> <p>(4) the seasonal space cooling energy efficiency <math>\eta_{s,c}</math> is calculated as defined in Regulation (EU) 2016/2281 the seasonal energy efficiency ratio SEER divided by the conversion coefficient CC (2.5), corrected by contributions accounting for temperature control (0.03).</p> <p>(5) Seasonal energy performance Ratio as defined in Regulation (EU) 2016/2281 for a high temperature process chiller at standard rating conditions defined in EN14511:2</p> <p>(6) minimum flow rate to be reached in variable water flow system (not managed by the unit controller BMS) with unit operating at minimum load.</p> <p>(7) not including filter pressure drop. The installation of the filter is mandatory.</p> <p>(8) sound power level measured in accordance to ISO9614, referred to unit operating at Standard Rating Conditions for Air to water chillers according to EN14511:2 Outdoor Heat exchanger inlet dry bulb temperature 35°; Indoor heat exchanger inlet water temperature 12°C, outlet water temperature 7°C</p> <p>(9) sound power level measured in accordance to ISO3744, referred to unit operating at Standard Rating Conditions for Air to water chillers according to EN14511:2 Outdoor Heat exchanger inlet dry bulb temperature 35°; Indoor heat exchanger inlet water temperature 12°C, outlet water temperature 7°C</p> <p>(10) referred to unit with free discharge on condenser fans.</p> <p>(11) data subject to change. Refer to unit's name plate for actual value.</p>								
<p>Data certified by Eurovent certification scheme</p> <p>The above data are referred to the unit without additional optional.</p> <p>The above data are referred the unit installed in compliancy with installation prescription.</p> <p>All the data are subject to change without notice. For updated information on project base refer to Chiller Selection Software and unit's certified drawing</p>								



EWAH~TZ- XS C + OPT158 – BRUSHLESS FANS UP TO 900 RPM						
MODEL	notes		C12	C13	C14	C15
Cooling Capacity	(1)	kW	1236	1346	1442	1526
Power Input	(1)	kW	373	413	452	498
EER	(1)	kW/kW	3,31	3,26	3,19	3,06
Minimum capacity	(2)	%	12,5	12,5	12,5	12,5
SEER	(3)	kW/kW	5,71	5,72	5,67	5,65
$\eta_{s,c}$	(4)	%	225	226	224	223
Evaporator type						
		-	Direct Expansion – Shell & Tubes			
Water flow rate	(1)	l/s	58,9	64,2	68,7	72,7
Evaporator pressure drop	(1) (7)	kPa	35,2	41,1	46,5	51,5
Evaporator water volume	(8)	lt	1011	1011	1011	1011
Minimum water rate	(6)	l/s	22,7	22,7	22,7	22,7
Sound Power						
	(1) (8)	dB(A)	104	105	106	107
Sound Pressure @ 1 m						
	(1) (9)	dB(A)	82	82	83	84
Fan type						
		-	Direct Propeller			
Fan diameter		mm	800			
Fan rotational speed		RPM	900	900	900	900
Fan motor / control						
		-	EC Brushless Fan			
Number of fans		n	24	26	28	30
Power input fans		kW	34,6	37,4	40,3	43,2
Air flow	(10)	l/s	116667	126389	136111	145833
Refrigerant circuits						
		n	2	2	2	2
Refrigerant type / GWP						
		-	R1234ze(E) / GWP = 7			
Refrigerant Charge						
	(11)	kg	200	220	250	270
Compressor type						
		-	Single Screw			
Capacity control						
		-	Stepless – Variable Frequency Drive			
Oil charge		lt	25	25	25	25
Casing material						
		-	Galvanized Steel Sheet			
Color						
		-	Ivory White			
Unit length		mm	11402	12302	13202	14102
Unit width		mm	2280	2280	2280	2280
Unit height		mm	2540	2540	2540	2540
Unit weight - shipping		kg	10716	11134	11564	12037
Unit weight - operation		kg	11727	12145	12575	13048
Water connection size		mm	273,0	273,0	273,0	273,0
Water connection type						
		-	Victaulic			
<p>(1) Standard Rating Conditions for Air to water chillers according to EN14511:2 Outdoor Heat exchanger inlet dry bulb temperature 35°; Indoor heat exchanger inlet water temperature 12°C, outlet water temperature 7°C. Fouling factor = 0</p> <p>(2) Minimum capacity for the unit operating at Standard Rating Conditions: Operating Ambient Temperature 35°C, Evaporator, water outlet 7°C</p> <p>(3) Seasonal Energy Efficiency Ratio as defined in EN14825, part load condition in cooling for Air to Water units, fan coil application, variable outlet, variable flow.</p> <p>(4) the seasonal space cooling energy efficiency <math>\eta_{s,c}</math> is calculated as defined in Regulation (EU) 2016/2281 the seasonal energy efficiency ratio SEER divided by the conversion coefficient CC (2.5), corrected by contributions accounting for temperature control (0.03).</p> <p>(5) Seasonal energy performance Ratio as defined in Regulation (EU) 2016/2281 for a high temperature process chiller at standard rating conditions defined in EN14511:2</p> <p>(6) minimum flow rate to be reached in variable water flow system (not managed by the unit controller BMS) with unit operating at minimum load.</p> <p>(7) not including filter pressure drop. The installation of the filter is mandatory.</p> <p>(8) sound power level measured in accordance to ISO9614, referred to unit operating at Standard Rating Conditions for Air to water chillers according to EN14511:2 Outdoor Heat exchanger inlet dry bulb temperature 35°; Indoor heat exchanger inlet water temperature 12°C, outlet water temperature 7°C</p> <p>(9) sound power level measured in accordance to ISO3744, referred to unit operating at Standard Rating Conditions for Air to water chillers according to EN14511:2 Outdoor Heat exchanger inlet dry bulb temperature 35°; Indoor heat exchanger inlet water temperature 12°C, outlet water temperature 7°C</p> <p>(10) referred to unit with free discharge on condenser fans.</p> <p>(11) data subject to change. Refer to unit's name plate for actual value.</p>						
<p>■ Data certified by Eurovent certification scheme</p> <p>The above data are referred to the unit without additional optional.</p> <p>The above data are referred the unit installed in compliancy with installation prescription.</p> <p>All the data are subject to change without notice. For updated information on project base refer to Chiller Selection Software and unit's certified drawing</p>						

EWAH~TZ- XL C + OPT159 – BRUSHLESS FANS UP TO 700 RPM								
MODEL	notes		670	780	840	950	C10	C11
Cooling Capacity	(1)	kW	669,7	783,9	840,7	948,2	1015	1120
Power Input	(1)	kW	204	240	258	289	308	348
EER	(1)	kW/kW	3,28	3,27	3,26	3,28	3,30	3,22
Minimum capacity	(2)	%	12,5	12,5	12,5	12,5	12,5	12,5
SEER	(3)	kW/kW	5,42	5,45	5,48	5,55	5,58	5,46
$\eta_{s,c}$	(4)	%	214	215	216	219	220	215,4
Evaporator type								
		-	Direct Expansion – Shell & Tubes					
Water flow rate	(1)	l/s	31,9	37,4	40,1	45,2	48,4	53,4
Evaporator pressure drop	(1) (7)	kPa	39,9	48,5	55,0	55,4	37,2	44,5
Evaporator water volume	(8)	lt	280	492	492	583	1043	1043
Minimum water rate	(6)	l/s	12,9	12,3	12,3	14,6	18,1	18,1
Sound Power								
Sound Power	(1) (8)	dB(A)	93	95	95	96	98	99
Sound Pressure @ 1 m	(1) (9)	dB(A)	72	73	73	74	75	76
Sound Power + opt76b	(1) (8)	dB(A)	90	91	92	93	94	95
Sound Pressure @ 1 m + opt76b	(1) (9)	dB(A)	69	70	70	71	71	72
Fan type								
		-	Direct Propeller					
Fan diameter		mm	800					
Fan rotational speed		RPM	700	700	700	700	700	700
Fan motor / control		-	EC Brushless Fan					
Number of fans		n	14	16	18	22	24	26
Power input fans		kW	9,8	11,2	12,6	15,4	16,8	18,2
Air flow	(10)	l/s	51722	59111	66500	81278	88667	96056
Refrigerant circuits								
		n	2	2	2	2	2	2
Refrigerant type / GWP		-	R1234ze(E) / GWP = 7					
Refrigerant Charge	(11)	kg	120	130	141	175	200	220
Compressor type								
		-	Single Screw					
Capacity control		-	Stepless – Variable Frequency Drive					
Oil charge		lt	16	16	16	16	16	16
Casing material		-	Galvanized Steel Sheet					
Color		-	Ivory White					
Unit length		mm	6909	7809	8709	10510	11402	12302
Unit width		mm	2280	2280	2280	2280	2280	2280
Unit height		mm	2540	2540	2540	2540	2540	2540
Unit weight - shipping		kg	7033	7660	8093	9288	10073	10475
Unit weight - operation		kg	7313	8152	8585	9871	11116	11518
Water connection size		mm	168,3	219,1	219,1	219,1	273,0	273,0
Water connection type		-	Victaulic					
<p>(1) Standard Rating Conditions for Air to water chillers according to EN14511:2 Outdoor Heat exchanger inlet dry bulb temperature 35°; Indoor heat exchanger inlet water temperature 12°C, outlet water temperature 7°C. Fouling factor = 0</p> <p>(2) Minimum capacity for the unit operating at Standard Rating Conditions: Operating Ambient Temperature 35°C, Evaporator, water outlet 7°C</p> <p>(3) Seasonal Energy Efficiency Ratio as defined in EN14825, part load condition in cooling for Air to Water units, fan coil application, variable outlet, variable flow.</p> <p>(4) the seasonal space cooling energy efficiency <math>\eta_{s,c}</math> is calculated as defined in Regulation (EU) 2016/2281 the seasonal energy efficiency ratio SEER divided by the conversion coefficient CC (2.5), corrected by contributions accounting for temperature control (0.03).</p> <p>(5) Seasonal energy performance Ratio as defined in Regulation (EU) 2016/2281 for a high temperature process chiller at standard rating conditions defined in EN14511:2</p> <p>(6) minimum flow rate to be reached in variable water flow system (not managed by the unit controller BMS) with unit operating at minimum load.</p> <p>(7) not including filter pressure drop. The installation of the filter is mandatory.</p> <p>(8) sound power level measured in accordance to ISO9614, referred to unit operating at Standard Rating Conditions for Air to water chillers according to EN14511:2 Outdoor Heat exchanger inlet dry bulb temperature 35°; Indoor heat exchanger inlet water temperature 12°C, outlet water temperature 7°C</p> <p>(9) sound power level measured in accordance to ISO3744, referred to unit operating at Standard Rating Conditions for Air to water chillers according to EN14511:2 Outdoor Heat exchanger inlet dry bulb temperature 35°; Indoor heat exchanger inlet water temperature 12°C, outlet water temperature 7°C referred to unit with free discharge on condenser fans.</p> <p>(10) referred to unit with free discharge on condenser fans.</p> <p>(11) data subject to change. Refer to unit's name plate for actual value.</p>								
<p>Data certified by Eurovent certification scheme</p> <p>The above data are referred to the unit without additional optional.</p> <p>The above data are referred the unit installed in compliancy with installation prescription.</p> <p>All the data are subject to change without notice. For updated information on project base refer to Chiller Selection Software and unit's certified drawing</p>								

EWAH~TZ- XL C + OPT158 – BRUSHLESS FANS UP TO 900 RPM						
MODEL	notes		C12	C13	C14	C15
Cooling Capacity	(1)	kW	1236	1346	1442	1526
Power Input	(1)	kW	373	413	452	498
EER	(1)	kW/kW	3,31	3,26	3,19	3,06
Minimum capacity	(2)	%	12,5	12,5	12,5	12,5
SEER	(3)	kW/kW	5,71	5,72	5,67	5,65
$\eta_{s,c}$	(4)	%	225	226	224	223
Evaporator type						
		-	Direct Expansion – Shell & Tubes			
Water flow rate	(1)	l/s	58,9	64,2	68,7	72,7
Evaporator pressure drop	(1) (7)	kPa	35,2	41,1	46,5	51,5
Evaporator water volume	(8)	lt	1011	1011	1011	1011
Minimum water rate	(6)	l/s	22,7	22,7	22,7	22,7
Sound Power						
Sound Power	(1) (8)	dB(A)	101	102	102	103
Sound Pressure @ 1 m	(1) (9)	dB(A)	79	79	79	80
Sound Power + opt76b	(1) (8)	dB(A)	100	100	101	101
Sound Pressure @ 1 m + opt76b	(1) (9)	dB(A)	77	77	78	78
Fan type						
		-	Direct Propeller			
Fan diameter		mm	800			
Fan rotational speed		RPM	900	900	900	900
Fan motor / control		-	EC Brushless Fan			
Number of fans		n	24	26	28	30
Power input fans		kW	34,6	37,4	40,3	43,2
Air flow	(10)	l/s	116667	126389	136111	145833
Refrigerant circuits						
		n	2	2	2	2
Refrigerant type / GWP						
		-	R1234ze(E) / GWP = 7			
Refrigerant Charge						
	(11)	kg	200	220	250	270
Compressor type						
		-	Single Screw			
Capacity control						
		-	Stepless – Variable Frequency Drive			
Oil charge						
		lt	25	25	25	25
Casing material						
		-	Galvanized Steel Sheet			
Color						
		-	Ivory White			
Unit length						
		mm	11402	12302	13202	14102
Unit width						
		mm	2280	2280	2280	2280
Unit height						
		mm	2540	2540	2540	2540
Unit weight - shipping						
		kg	10716	11134	11564	12037
Unit weight - operation						
		kg	11727	12145	12575	13048
Water connection size						
		mm	273,0	273,0	273,0	273,0
Water connection type						
		-	Victaulic			
<p>(1) Standard Rating Conditions for Air to water chillers according to EN14511:2 Outdoor Heat exchanger inlet dry bulb temperature 35°; Indoor heat exchanger inlet water temperature 12°C, outlet water temperature 7°C. Fouling factor = 0</p> <p>(2) Minimum capacity for the unit operating at Standard Rating Conditions: Operating Ambient Temperature 35°C, Evaporator, water outlet 7°C</p> <p>(3) Seasonal Energy Efficiency Ratio as defined in EN14825, part load condition in cooling for Air to Water units, fan coil application, variable outlet, variable flow.</p> <p>(4) the seasonal space cooling energy efficiency <math>\eta_{s,c}</math> is calculated as defined in Regulation (EU) 2016/2281 the seasonal energy efficiency ratio SEER divided by the conversion coefficient CC (2.5), corrected by contributions accounting for temperature control (0.03).</p> <p>(5) Seasonal energy performance Ratio as defined in Regulation (EU) 2016/2281 for a high temperature process chiller at standard rating conditions defined in EN14511:2</p> <p>(6) minimum flow rate to be reached in variable water flow system (not managed by the unit controller BMS) with unit operating at minimum load.</p> <p>(7) not including filter pressure drop. The installation of the filter is mandatory.</p> <p>(8) sound power level measured in accordance to ISO9614, referred to unit operating at Standard Rating Conditions for Air to water chillers according to EN14511:2 Outdoor Heat exchanger inlet dry bulb temperature 35°; Indoor heat exchanger inlet water temperature 12°C, outlet water temperature 7°C</p> <p>(9) sound power level measured in accordance to ISO3744, referred to unit operating at Standard Rating Conditions for Air to water chillers according to EN14511:2 Outdoor Heat exchanger inlet dry bulb temperature 35°; Indoor heat exchanger inlet water temperature 12°C, outlet water temperature 7°C referred to unit with free discharge on condenser fans.</p> <p>(10) referred to unit with free discharge on condenser fans.</p> <p>(11) data subject to change. Refer to unit's name plate for actual value.</p>						
<p>Data certified by Eurovent certification scheme</p> <p>The above data are referred to the unit without additional optional.</p> <p>The above data are referred the unit installed in compliance with installation prescription.</p> <p>All the data are subject to change without notice. For updated information on project base refer to Chiller Selection Software and unit's certified drawing</p>						

EWAH~TZ- XR C + OPT159 – BRUSHLESS FANS UP TO 700 RPM								
MODEL	notes		670	780	840	950	C10	C11
Cooling Capacity	(1)	kW	669,5	783,6	840,5	947,9	1014	1120
Power Input	(1)	kW	204	241	259	290	308	349
EER	(1)	kW/kW	3,28	3,25	3,24	3,27	3,30	3,21
Minimum capacity	(2)	%	12,5	12,5	12,5	12,5	12,5	12,5
SEER	(3)	kW/kW	5,40	5,46	5,48	5,56	5,59	5,46
$\eta_{s,c}$	(4)	%	213	215	216	219	221	215
Evaporator type								
		-	Direct Expansion – Shell & Tubes					
Water flow rate	(1)	l/s	31,9	37,4	40,1	45,2	48,4	53,4
Evaporator pressure drop	(1) (7)	kPa	39,9	48,5	55,0	55,4	37,2	44,5
Evaporator water volume	(8)	lt	280	492	492	583	1043	1043
Minimum water rate	(6)	l/s	12,9	12,3	12,3	14,6	18,1	18,1
Sound Power								
	(1) (8)	dB(A)	90	91	92	93	94	95
Sound Pressure @ 1 m								
	(1) (9)	dB(A)	69	70	70	71	71	72
Fan type								
		-	Direct Propeller					
Fan diameter								
		mm	800					
Fan rotational speed								
		RPM	700	700	700	700	700	700
Fan motor / control								
		-	EC Brushless Fan					
Number of fans								
		n	14	16	18	22	24	26
Power input fans								
		kW	9,8	11,2	12,6	15,4	16,8	18,2
Air flow								
	(10)	l/s	51722	59111	66500	81278	88667	96056
Refrigerant circuits								
		n	2	2	2	2	2	2
Refrigerant type / GWP								
		-	R1234ze(E) / GWP = 7					
Refrigerant Charge								
	(11)	kg	120	130	141	175	200	220
Compressor type								
		-	Single Screw					
Capacity control								
		-	Stepless – Variable Frequency Drive					
Oil charge								
		lt	16	16	16	16	16	16
Casing material								
		-	Galvanized Steel Sheet					
Color								
		-	Ivory White					
Unit length								
		mm	6909	7809	8709	10510	11402	12302
Unit width								
		mm	2280	2280	2280	2280	2280	2280
Unit height								
		mm	2540	2540	2540	2540	2540	2540
Unit weight - shipping								
		kg	7033	7660	8093	9288	10073	10475
Unit weight - operation								
		kg	7313	8152	8585	9871	11116	11518
Water connection size								
		mm	168,3	219,1	219,1	219,1	273,0	273,0
Water connection type								
		-	Victaulic					
<p>(1) Standard Rating Conditions for Air to water chillers according to EN14511:2 Outdoor Heat exchanger inlet dry bulb temperature 35°; Indoor heat exchanger inlet water temperature 12°C, outlet water temperature 7°C. Fouling factor = 0</p> <p>(2) Minimum capacity for the unit operating at Standard Rating Conditions: Operating Ambient Temperature 35°C, Evaporator, water outlet 7°C</p> <p>(3) Seasonal Energy Efficiency Ratio as defined in EN14825, part load condition in cooling for Air to Water units, fan coil application, variable outlet, variable flow.</p> <p>(4) the seasonal space cooling energy efficiency <math>\eta_{s,c}</math> is calculated as defined in Regulation (EU) 2016/2281 the seasonal energy efficiency ratio SEER divided by the conversion coefficient CC (2.5), corrected by contributions accounting for temperature control (0.03).</p> <p>(5) Seasonal energy performance Ratio as defined in Regulation (EU) 2016/2281 for a high temperature process chiller at standard rating conditions defined in EN14511:2</p> <p>(6) minimum flow rate to be reached in variable water flow system (not managed by the unit controller BMS) with unit operating at minimum load.</p> <p>(7) not including filter pressure drop. The installation of the filter is mandatory.</p> <p>(8) sound power level measured in accordance to ISO9614, referred to unit operating at Standard Rating Conditions for Air to water chillers according to EN14511:2 Outdoor Heat exchanger inlet dry bulb temperature 35°; Indoor heat exchanger inlet water temperature 12°C, outlet water temperature 7°C</p> <p>(9) sound power level measured in accordance to ISO3744, referred to unit operating at Standard Rating Conditions for Air to water chillers according to EN14511:2 Outdoor Heat exchanger inlet dry bulb temperature 35°; Indoor heat exchanger inlet water temperature 12°C, outlet water temperature 7°C</p> <p>(10) referred to unit with free discharge on condenser fans.</p> <p>(11) data subject to change. Refer to unit's name plate for actual value.</p>								
<p>Data certified by Eurovent certification scheme</p> <p>The above data are referred to the unit without additional optional.</p> <p>The above data are referred the unit installed in compliancy with installation prescription.</p> <p>All the data are subject to change without notice. For updated information on project base refer to Chiller Selection Software and unit's certified drawing</p>								

EWAH~TZ- XR C + OPT159 – BRUSHLESS FANS UP TO 700 RPM						
MODEL	notes		C12	C13	C14	C15
Cooling Capacity	(1)	kW	1214	1322	1416	1498
Power Input	(1)	kW	379	422	463	510
EER	(1)	kW/kW	3,20	3,13	3,06	2,94
Minimum capacity	(2)	%	12,5	12,5	12,5	12,5
SEER	(3)	kW/kW	5,75	5,62	5,75	5,67
$\eta_{s,c}$	(4)	%	227	222	227	224
Evaporator type						
		-	Direct Expansion – Shell & Tubes			
Water flow rate	(1)	l/s	57,9	63,0	67,5	71,4
Evaporator pressure drop	(1) (7)	kPa	34,1	39,8	45,0	49,8
Evaporator water volume	(8)	lt	1011	1011	1011	1011
Minimum water rate	(6)	l/s	22,7	22,7	22,7	22,7
Sound Power						
Sound Power	(1) (8)	dB(A)	94	95	96	96
Sound Pressure @ 1 m	(1) (9)	dB(A)	72	72	72	73
Fan type						
		-	Direct Propeller			
Fan diameter		mm	800			
Fan rotational speed		RPM	700	700	700	700
Fan motor / control						
		-	EC Brushless Fan			
Number of fans		n	24	26	28	30
Power input fans		kW	16,8	18,2	19,6	21,0
Air flow	(10)	l/s	88667	96056	103444	110833
Refrigerant circuits						
		n	2	2	2	2
Refrigerant type / GWP						
		-	R1234ze(E) / GWP = 7			
Refrigerant Charge						
	(11)	kg	200	220	250	270
Compressor type						
		-	Single Screw			
Capacity control						
		-	Stepless – Variable Frequency Drive			
Oil charge		lt	25	25	25	25
Casing material						
		-	Galvanized Steel Sheet			
Color						
		-	Ivory White			
Unit length		mm	11402	12302	13202	14102
Unit width		mm	2280	2280	2280	2280
Unit height		mm	2540	2540	2540	2540
Unit weight - shipping		kg	10716	11134	11564	12037
Unit weight - operation		kg	11727	12145	12575	13048
Water connection size		mm	273,0	273,0	273,0	273,0
Water connection type						
		-	Victaulic			
<p>(1) Standard Rating Conditions for Air to water chillers according to EN14511:2 Outdoor Heat exchanger inlet dry bulb temperature 35°; Indoor heat exchanger inlet water temperature 12°C, outlet water temperature 7°C. Fouling factor = 0</p> <p>(2) Minimum capacity for the unit operating at Standard Rating Conditions: Operating Ambient Temperature 35°C, Evaporator, water outlet 7°C</p> <p>(3) Seasonal Energy Efficiency Ratio as defined in EN14825, part load condition in cooling for Air to Water units, fan coil application, variable outlet, variable flow.</p> <p>(4) the seasonal space cooling energy efficiency <math>\eta_{s,c}</math> is calculated as defined in Regulation (EU) 2016/2281 the seasonal energy efficiency ratio SEER divided by the conversion coefficient CC (2.5), corrected by contributions accounting for temperature control (0.03).</p> <p>(5) Seasonal energy performance Ratio as defined in Regulation (EU) 2016/2281 for a high temperature process chiller at standard rating conditions defined in EN14511:2</p> <p>(6) minimum flow rate to be reached in variable water flow system (not managed by the unit controller BMS) with unit operating at minimum load.</p> <p>(7) not including filter pressure drop. The installation of the filter is mandatory.</p> <p>(8) sound power level measured in accordance to ISO9614, referred to unit operating at Standard Rating Conditions for Air to water chillers according to EN14511:2 Outdoor Heat exchanger inlet dry bulb temperature 35°; Indoor heat exchanger inlet water temperature 12°C, outlet water temperature 7°C</p> <p>(9) sound power level measured in accordance to ISO3744, referred to unit operating at Standard Rating Conditions for Air to water chillers according to EN14511:2 Outdoor Heat exchanger inlet dry bulb temperature 35°; Indoor heat exchanger inlet water temperature 12°C, outlet water temperature 7°C</p> <p>(10) referred to unit with free discharge on condenser fans.</p> <p>(11) data subject to change. Refer to unit's name plate for actual value.</p>						
<p>Data certified by Eurovent certification scheme                      The above data are referred to the unit without additional optional.                      The above data are referred to the unit installed in compliancy with installation prescription.                      All the data are subject to change without notice. For updated information on project base refer to Chiller Selection Software and unit's certified drawing</p>						

EWAD~TZ- SS C + OPT158 – BRUSHLESS FANS UP TO 900 RPM								
MODEL	notes		H11	H12	H13	C15	C16	H17
Cooling Capacity	(1)	kW	1188	1258	1354	1507	1643	1764
Power Input	(1)	kW	376	408	433	480	527	575
EER	(1)	kW/kW	3,16	3,08	3,13	3,14	3,12	3,07
Minimum capacity	(2)	%	12,5	12,5	12,5	12,5	12,5	12,5
SEER	(3)	kW/kW	5,36	5,49	5,30	5,42	5,43	5,41
$\eta_{s,c}$	(4)	%	211	207	209	214	214	213
Evaporator type								
		-	Direct Expansion – Shell & Tubes					
Water flow rate	(1)	l/s	56,7	60,0	64,6	71,8	78,3	84,1
Evaporator pressure drop	(1) (7)	kPa	57,0	63,2	40,4	49,0	57,3	65,1
Evaporator water volume	(8)	lt	557	557	1011	1011	1011	1011
Minimum water rate	(6)	l/s	18,2	18,2	22,6	22,6	22,6	22,6
Sound Power								
	(1) (8)	dB(A)	102	103	104	104	105	105
Sound Pressure @ 1 m								
	(1) (9)	dB(A)	80	81	82	81	82	82
Fan type								
		-	Direct Propeller					
Fan diameter		mm	800					
Fan rotational speed		RPM	900					
Fan motor / control								
		-	EC Brushless Fan					
Number of fans		n	22	22	24	24	26	28
Power input fans		kW	31,7	31,7	34,6	34,6	37,4	40,3
Air flow	(10)	l/s	106944	106944	116667	116667	126389	136111
Refrigerant circuits								
		n	2	2	2	2	2	2
Refrigerant type / GWP								
		-	R134a / GWP = 1430					
Refrigerant Charge								
	(11)	kg	175	175	200	200	220	250
Compressor type								
		-	Single Screw					
Capacity control								
		-	Stepless – Variable Frequency Drive					
Oil charge								
		lt	16	16	16	25	25	25
Casing material								
		-	Galvanized Steel Sheet					
Color								
		-	Ivory White					
Unit length		mm	10510	10510	11404	11404	12302	13202
Unit width		mm	2280	2280	2280	2280	2280	2280
Unit height		mm	2540	2540	2540	2540	2540	2540
Unit weight - shipping		kg	9322	9322	10112	10716	11134	11564
Unit weight - operation		kg	9879	9879	11123	11727	12145	12575
Water connection size								
		mm	219,1	219,1	273,0	273,0	273,0	273,0
Water connection type								
		-	Victaulic					
<p>(1) Standard Rating Conditions for Air to water chillers according to EN14511:2 Outdoor Heat exchanger inlet dry bulb temperature 35°; Indoor heat exchanger inlet water temperature 12°C, outlet water temperature 7°C. Fouling factor = 0</p> <p>(2) Minimum capacity for the unit operating at Standard Rating Conditions: Operating Ambient Temperature 35°C, Evaporator, water outlet 7°C</p> <p>(3) Seasonal Energy Efficiency Ratio as defined in EN14825, part load condition in cooling for Air to Water units, fan coil application, variable outlet, variable flow.</p> <p>(4) the seasonal space cooling energy efficiency <math>\eta_{s,c}</math> is calculated as defined in Regulation (EU) 2016/2281 the seasonal energy efficiency ratio SEER divided by the conversion coefficient CC (2.5), corrected by contributions accounting for temperature control (0.03).</p> <p>(5) Seasonal energy performance Ratio as defined in Regulation (EU) 2016/2281 for a high temperature process chiller at standard rating conditions defined in EN14511:2</p> <p>(6) minimum flow rate to be reached in variable water flow system (not managed by the unit controller BMS) with unit operating at minimum load.</p> <p>(7) not including filter pressure drop. The installation of the filter is mandatory.</p> <p>(8) sound power level measured in accordance to ISO9614, referred to unit operating at Standard Rating Conditions for Air to water chillers according to EN14511:2 Outdoor Heat exchanger inlet dry bulb temperature 35°; Indoor heat exchanger inlet water temperature 12°C, outlet water temperature 7°C</p> <p>(9) sound power level measured in accordance to ISO3744, referred to unit operating at Standard Rating Conditions for Air to water chillers according to EN14511:2 Outdoor Heat exchanger inlet dry bulb temperature 35°; Indoor heat exchanger inlet water temperature 12°C, outlet water temperature 7°C</p> <p>(10) referred to unit with free discharge on condenser fans.</p> <p>(11) data subject to change. Refer to unit's name plate for actual value.</p>								
<p>Data certified by Eurovent certification scheme</p> <p>The above data are referred to the unit without additional optional.</p> <p>The above data are referred the unit installed in compliancy with installation prescription.</p> <p>All the data are subject to change without notice. For updated information on project base refer to Chiller Selection Software and unit's certified drawing</p>								

EWAD~TZ- SS C + OPT158 – BRUSHLESS FANS UP TO 900 RPM				
MODEL	notes		H18	H19
Cooling Capacity	(1)	kW	1873	1962
Power Input	(1)	kW	629	702
EER	(1)	kW/kW	2,98	2,79
Minimum capacity	(2)	%	12,5	12,5
SEER	(3)	kW/kW	5,40	5,34
$\eta_{s,c}$	(4)	%	213	211
Evaporator type				
		-	Direct Expansion – Shell & Tubes	
Water flow rate	(1)	l/s	89,3	93,6
Evaporator pressure drop	(1) (7)	kPa	72,5	78,8
Evaporator water volume	(8)	lt	1011	1011
Minimum water rate	(6)	l/s	22,6	22,6
Sound Power				
	(1) (8)	dB(A)	106	107
Sound Pressure @ 1 m				
	(1) (9)	dB(A)	83	84
Fan type				
		-	Direct Propeller	
Fan diameter		mm	800	
Fan rotational speed		RPM	900	
Fan motor / control				
		-	EC Brushless Fan	
Number of fans		n	30	30
Power input fans		kW	43,2	43,2
Air flow	(10)	l/s	145833	145833
Refrigerant circuits				
		n	2	2
Refrigerant type / GWP				
		-	R134a / GWP = 1430	
Refrigerant Charge	(11)	kg	270	270
Compressor type				
		-	Single Screw	
Capacity control				
		-	Stepless – Variable Frequency Drive	
Oil charge		lt	25	25
Casing material				
		-	Galvanized Steel Sheet	
Color				
		-	Ivory White	
Unit length		mm	14102	14102
Unit width		mm	2280	2280
Unit height		mm	2540	2540
Unit weight - shipping		kg	12037	12037
Unit weight - operation		kg	13048	13048
Water connection size		mm	273,0	273,0
Water connection type				
		-	Victaulic	
<p>(1) Standard Rating Conditions for Air to water chillers according to EN14511:2 Outdoor Heat exchanger inlet dry bulb temperature 35°; Indoor heat exchanger inlet water temperature 12°C, outlet water temperature 7°C. Fouling factor = 0</p> <p>(2) Minimum capacity for the unit operating at Standard Rating Conditions: Operating Ambient Temperature 35°C, Evaporator, water outlet 7°C</p> <p>(3) Seasonal Energy Efficiency Ratio as defined in EN14825, part load condition in cooling for Air to Water units, fan coil application, variable outlet, variable flow.</p> <p>(4) the seasonal space cooling energy efficiency <math>\eta_{s,c}</math> is calculated as defined in Regulation (EU) 2016/2281 the seasonal energy efficiency ratio SEER divided by the conversion coefficient CC (2,5), corrected by contributions accounting for temperature control (0,03).</p> <p>(5) Seasonal energy performance Ratio as defined in Regulation (EU) 2016/2281 for a high temperature process chiller at standard rating conditions defined in EN14511:2</p> <p>(6) minimum flow rate to be reached in variable water flow system (not managed by the unit controller BMS) with unit operating at minimum load.</p> <p>(7) not including filter pressure drop. The installation of the filter is mandatory.</p> <p>(8) sound power level measured in accordance to ISO9614, referred to unit operating at Standard Rating Conditions for Air to water chillers according to EN14511:2 Outdoor Heat exchanger inlet dry bulb temperature 35°; Indoor heat exchanger inlet water temperature 12°C, outlet water temperature 7°C</p> <p>(9) sound power level measured in accordance to ISO3744, referred to unit operating at Standard Rating Conditions for Air to water chillers according to EN14511:2 Outdoor Heat exchanger inlet dry bulb temperature 35°; Indoor heat exchanger inlet water temperature 12°C, outlet water temperature 7°C</p> <p>(10) referred to unit with free discharge on condenser fans.</p> <p>(11) data subject to change. Refer to unit's name plate for actual value.</p>				
<p>Data certified by Eurovent certification scheme  The above data are referred to the unit without additional optional.  The above data are referred the unit installed in compliancy with installation prescription.  All the data are subject to change without notice. For updated information on project base refer to Chiller Selection Software and unit's certified drawing</p>				



EWAD~TZ- SL C + OPT158 – BRUSHLESS FANS UP TO 900 RPM								
MODEL	notes		H11	H12	H13	C15	C16	H17
Cooling Capacity	(1)	kW	1188	1258	1354	1507	1643	1764
Power Input	(1)	kW	376	408	433	480	527	575
EER	(1)	kW/kW	3,16	3,08	3,13	3,14	3,12	3,07
Minimum capacity	(2)	%	12,5	12,5	12,5	12,5	12,5	12,5
SEER	(3)	kW/kW	5,36	5,26	5,30	5,42	5,43	5,41
$\eta_{s,c}$	(4)	%	211	207	209	214	214	213
Evaporator type								
		-	Direct Expansion – Shell & Tubes					
Water flow rate	(1)	l/s	56,7	60,0	64,6	71,8	78,3	84,1
Evaporator pressure drop	(1) (7)	kPa	57,0	63,2	40,4	49,0	57,3	65,1
Evaporator water volume	(8)	lt	557	557	1011	1011	1011	1011
Minimum water rate	(6)	l/s	18,2	18,2	22,6	22,6	22,6	22,6
Sound Power								
Sound Power	(1) (8)	dB(A)	100	100	101	101	101	102
Sound Pressure @ 1 m	(1) (9)	dB(A)	77	78	78	78	79	79
Sound Power + opt76b	(1) (8)	dB(A)	99	99	100	100	100	100
Sound Pressure @ 1 m + opt76b	(1) (9)	dB(A)	77	77	77	77	77	77
Fan type								
		-	Direct Propeller					
Fan diameter		mm	800					
Fan rotational speed		RPM	900					
Fan motor / control		-	EC Brushless Fan					
Number of fans		n	22	22	24	24	26	28
Power input fans		kW	31,7	31,7	34,6	34,6	37,4	40,3
Air flow	(10)	l/s	106944	106944	116667	116667	126389	136111
Refrigerant circuits								
		n	2	2	2	2	2	2
Refrigerant type / GWP								
		-	R134a / GWP = 1430					
Refrigerant Charge	(11)	kg	175	175	200	200	220	250
Compressor type								
		-	Single Screw					
Capacity control								
		-	Stepless – Variable Frequency Drive					
Oil charge		lt	16	16	16	25	25	25
Casing material								
		-	Galvanized Steel Sheet					
Color								
		-	Ivory White					
Unit length		mm	10510	10510	11404	11404	12302	13202
Unit width		mm	2280	2280	2280	2280	2280	2280
Unit height		mm	2540	2540	2540	2540	2540	2540
Unit weight - shipping		kg	9322	9322	10112	10716	11134	11564
Unit weight - operation		kg	9879	9879	11123	11727	12145	12575
Water connection size		mm	219,1	219,1	273,0	273,0	273,0	273,0
Water connection type								
		-	Victaulic					
<p>(1) Standard Rating Conditions for Air to water chillers according to EN14511:2 Outdoor Heat exchanger inlet dry bulb temperature 35°; Indoor heat exchanger inlet water temperature 12°C, outlet water temperature 7°C. Fouling factor = 0</p> <p>(2) Minimum capacity for the unit operating at Standard Rating Conditions: Operating Ambient Temperature 35°C, Evaporator, water outlet 7°C</p> <p>(3) Seasonal Energy Efficiency Ratio as defined in EN14825, part load condition in cooling for Air to Water units, fan coil application, variable outlet, variable flow.</p> <p>(4) the seasonal space cooling energy efficiency <math>\eta_{s,c}</math> is calculated as defined in Regulation (EU) 2016/2281 the seasonal energy efficiency ratio SEER divided by the conversion coefficient CC (2.5), corrected by contributions accounting for temperature control (0.03).</p> <p>(5) Seasonal energy performance Ratio as defined in Regulation (EU) 2016/2281 for a high temperature process chiller at standard rating conditions defined in EN14511:2</p> <p>(6) minimum flow rate to be reached in variable water flow system (not managed by the unit controller BMS) with unit operating at minimum load.</p> <p>(7) not including filter pressure drop. The installation of the filter is mandatory.</p> <p>(8) sound power level measured in accordance to ISO9614, referred to unit operating at Standard Rating Conditions for Air to water chillers according to EN14511:2 Outdoor Heat exchanger inlet dry bulb temperature 35°; Indoor heat exchanger inlet water temperature 12°C, outlet water temperature 7°C</p> <p>(9) sound power level measured in accordance to ISO3744, referred to unit operating at Standard Rating Conditions for Air to water chillers according to EN14511:2 Outdoor Heat exchanger inlet dry bulb temperature 35°; Indoor heat exchanger inlet water temperature 12°C, outlet water temperature 7°C referred to unit with free discharge on condenser fans.</p> <p>(10) referred to unit with free discharge on condenser fans.</p> <p>(11) data subject to change. Refer to unit's name plate for actual value.</p>								
<p>Data certified by Eurovent certification scheme</p> <p>The above data are referred to the unit without additional optional.</p> <p>The above data are referred the unit installed in compliance with installation prescription.</p> <p>All the data are subject to change without notice. For updated information on project base refer to Chiller Selection Software and unit's certified drawing</p>								

EWAD~TZ- SL C + OPT158 – BRUSHLESS FANS UP TO 900 RPM				
MODEL	notes		H18	H19
Cooling Capacity	(1)	kW	1873	1962
Power Input	(1)	kW	629	702
EER	(1)	kW/kW	2,98	2,79
Minimum capacity	(2)	%	12,5	12,5
SEER	(3)	kW/kW	5,40	5,34
$\eta_{s,c}$	(4)	%	213	211
Evaporator type				
		-	Direct Expansion – Shell & Tubes	
Water flow rate	(1)	l/s	89,3	93,6
Evaporator pressure drop	(1) (7)	kPa	72,5	78,8
Evaporator water volume	(8)	lt	1011	1011
Minimum water rate	(6)	l/s	22,6	22,6
Sound Power				
Sound Power	(1) (8)	dB(A)	103	103
Sound Pressure @ 1 m	(1) (9)	dB(A)	79	80
Sound Power +opt76b	(1) (8)	dB(A)	101	101
Sound Pressure @ 1 m +opt76b	(1) (9)	dB(A)	78	78
Fan type				
		-	Direct Propeller	
Fan diameter		mm	800	
Fan rotational speed		RPM	900	
Fan motor / control		-	EC Brushless Fan	
Number of fans		n	30	30
Power input fans		kW	43,2	43,2
Air flow	(10)	l/s	145833	145833
Refrigerant circuits				
		n	2	2
Refrigerant type / GWP				
		-	R134a / GWP = 1430	
Refrigerant Charge	(11)	kg	270	270
Compressor type				
		-	Single Screw	
Capacity control				
		-	Stepless – Variable Frequency Drive	
Oil charge		lt	25	25
Casing material				
		-	Galvanized Steel Sheet	
Color				
		-	Ivory White	
Unit length		mm	14102	14102
Unit width		mm	2280	2280
Unit height		mm	2540	2540
Unit weight - shipping		kg	12037	12037
Unit weight - operation		kg	13048	13048
Water connection size		mm	273,0	273,0
Water connection type				
		-	Victaulic	
<p>(1) Standard Rating Conditions for Air to water chillers according to EN14511:2 Outdoor Heat exchanger inlet dry bulb temperature 35°; Indoor heat exchanger inlet water temperature 12°C, outlet water temperature 7°C. Fouling factor = 0</p> <p>(2) Minimum capacity for the unit operating at Standard Rating Conditions: Operating Ambient Temperature 35°C, Evaporator, water outlet 7°C</p> <p>(3) Seasonal Energy Efficiency Ratio as defined in EN14825, part load condition in cooling for Air to Water units, fan coil application, variable outlet, variable flow.</p> <p>(4) the seasonal space cooling energy efficiency <math>\eta_{s,c}</math> is calculated as defined in Regulation (EU) 2016/2281 the seasonal energy efficiency ratio SEER divided by the conversion coefficient CC (2.5), corrected by contributions accounting for temperature control (0.03).</p> <p>(5) Seasonal energy performance Ratio as defined in Regulation (EU) 2016/2281 for a high temperature process chiller at standard rating conditions defined in EN14511:2</p> <p>(6) minimum flow rate to be reached in variable water flow system (not managed by the unit controller BMS) with unit operating at minimum load.</p> <p>(7) not including filter pressure drop. The installation of the filter is mandatory.</p> <p>(8) sound power level measured in accordance to ISO9614, referred to unit operating at Standard Rating Conditions for Air to water chillers according to EN14511:2 Outdoor Heat exchanger inlet dry bulb temperature 35°; Indoor heat exchanger inlet water temperature 12°C, outlet water temperature 7°C</p> <p>(9) sound power level measured in accordance to ISO3744, referred to unit operating at Standard Rating Conditions for Air to water chillers according to EN14511:2 Outdoor Heat exchanger inlet dry bulb temperature 35°; Indoor heat exchanger inlet water temperature 12°C, outlet water temperature 7°C</p> <p>(10) referred to unit with free discharge on condenser fans.</p> <p>(11) data subject to change. Refer to unit's name plate for actual value.</p>				
<p>■ Data certified by Eurovent certification scheme</p> <p>The above data are referred to the unit without additional optional.</p> <p>The above data are referred the unit installed in compliancy with installation prescription.</p> <p>All the data are subject to change without notice. For updated information on project base refer to Chiller Selection Software and unit's certified drawing</p>				

EWAD~TZ- SR C + OPT159 – BRUSHLESS FANS UP TO 700 RPM								
MODEL	notes		H11	H12	H13	C15	C16	H17
Cooling Capacity	(1)	kW	1165	1230	1324	1464	1597	1713
Power Input	(1)	kW	382	420	443	510	560	607
EER	(1)	kW/kW	3,05	2,93	2,99	2,87	2,85	2,82
Minimum capacity	(2)	%	12,5	12,5	12,5	12,5	12,5	12,5
SEER	(3)	kW/kW	5,35	5,20	5,31	5,26	5,35	5,38
$\eta_{s,c}$	(4)	%	211	205	209	207	211	212
Evaporator type								
		-	Direct Expansion – Shell & Tubes					
Water flow rate	(1)	l/s	55,6	58,7	63,1	69,8	76,2	81,7
Evaporator pressure drop	(1) (7)	kPa	55,1	60,7	38,8	46,5	54,4	61,8
Evaporator water volume	(8)	lt	557	557	1011	1011	1011	1011
Minimum water rate	(6)	l/s	18,2	18,2	22,6	22,6	22,6	22,6
Sound Power								
	(1) (8)	dB(A)	93	93	94	94	94	95
Sound Pressure @ 1 m								
	(1) (9)	dB(A)	70	71	71	71	71	72
Fan type								
		-	Direct Propeller					
Fan diameter		mm	800					
Fan rotational speed		RPM	700					
Fan motor / control								
		-	EC Brushless Fan					
Number of fans		n	22	22	24	24	26	28
Power input fans		kW	15,4	15,4	16,8	16,8	18,2	19,6
Air flow	(10)	l/s	81278	81278	88667	88667	96056	103444
Refrigerant circuits								
		n	2	2	2	2	2	2
Refrigerant type / GWP								
		-	R134a / GWP = 1430					
Refrigerant Charge								
	(11)	kg	175	175	200	200	220	250
Compressor type								
		-	Single Screw					
Capacity control								
		-	Stepless – Variable Frequency Drive					
Oil charge								
		lt	16	16	16	25	25	25
Casing material								
		-	Galvanized Steel Sheet					
Color								
		-	Ivory White					
Unit length		mm	10510	10510	11404	11404	12302	13202
Unit width		mm	2280	2280	2280	2280	2280	2280
Unit height		mm	2540	2540	2540	2540	2540	2540
Unit weight - shipping		kg	9322	9322	10112	10716	11134	11564
Unit weight - operation		kg	9879	9879	11123	11727	12145	12575
Water connection size								
		mm	219,1	219,1	273,0	273,0	273,0	273,0
Water connection type								
		-	Victaulic					
<p>(1) Standard Rating Conditions for Air to water chillers according to EN14511:2 Outdoor Heat exchanger inlet dry bulb temperature 35°; Indoor heat exchanger inlet water temperature 12°C, outlet water temperature 7°C. Fouling factor = 0</p> <p>(2) Minimum capacity for the unit operating at Standard Rating Conditions: Operating Ambient Temperature 35°C, Evaporator, water outlet 7°C</p> <p>(3) Seasonal Energy Efficiency Ratio as defined in EN14825, part load condition in cooling for Air to Water units, fan coil application, variable outlet, variable flow.</p> <p>(4) the seasonal space cooling energy efficiency <math>\eta_{s,c}</math> is calculated as defined in Regulation (EU) 2016/2281 the seasonal energy efficiency ratio SEER divided by the conversion coefficient CC (2.5), corrected by contributions accounting for temperature control (0.03).</p> <p>(5) Seasonal energy performance Ratio as defined in Regulation (EU) 2016/2281 for a high temperature process chiller at standard rating conditions defined in EN14511:2</p> <p>(6) minimum flow rate to be reached in variable water flow system (not managed by the unit controller BMS) with unit operating at minimum load.</p> <p>(7) not including filter pressure drop. The installation of the filter is mandatory.</p> <p>(8) sound power level measured in accordance to ISO9614, referred to unit operating at Standard Rating Conditions for Air to water chillers according to EN14511:2 Outdoor Heat exchanger inlet dry bulb temperature 35°; Indoor heat exchanger inlet water temperature 12°C, outlet water temperature 7°C</p> <p>(9) sound power level measured in accordance to ISO3744, referred to unit operating at Standard Rating Conditions for Air to water chillers according to EN14511:2 Outdoor Heat exchanger inlet dry bulb temperature 35°; Indoor heat exchanger inlet water temperature 12°C, outlet water temperature 7°C</p> <p>(10) referred to unit with free discharge on condenser fans.</p> <p>(11) data subject to change. Refer to unit's name plate for actual value.</p>								
<p>■ Data certified by Eurovent certification scheme</p> <p>The above data are referred to the unit without additional optional.</p> <p>The above data are referred the unit installed in compliancy with installation prescription.</p> <p>All the data are subject to change without notice. For updated information on project base refer to Chiller Selection Software and unit's certified drawing</p>								

EWAD~TZ- SR C + OPT159 – BRUSHLESS FANS UP TO 700 RPM				
MODEL	notes		H18	H19
Cooling Capacity	(1)	kW	1813	1878
Power Input	(1)	kW	659	736
EER	(1)	kW/kW	2,75	2,55
Minimum capacity	(2)	%	12,5	12,5
SEER	(3)	kW/kW	5,33	5,10
$\eta_{s,c}$	(4)	%	210	201
Evaporator type				
		-	Direct Expansion – Shell & Tubes	
Water flow rate	(1)	l/s	86,5	89,6
Evaporator pressure drop	(1) (7)	kPa	68,4	72,9
Evaporator water volume	(8)	lt	1011	1011
Minimum water rate	(6)	l/s	22,6	22,6
Sound Power				
	(1) (8)	dB(A)	96	96
Sound Pressure @ 1 m	(1) (9)	dB(A)	72	73
Fan type				
		-	Direct Propeller	
Fan diameter		mm	800	
Fan rotational speed		RPM	700	
Fan motor / control		-	EC Brushless Fan	
Number of fans		n	30	30
Power input fans		kW	21,0	21,0
Air flow	(10)	l/s	110833	110833
Refrigerant circuits				
		n	2	2
Refrigerant type / GWP		-	R134a / GWP = 1430	
Refrigerant Charge	(11)	kg	270	270
Compressor type				
		-	Single Screw	
Capacity control		-	Stepless – Variable Frequency Drive	
Oil charge		lt	25	25
Casing material		-	Galvanized Steel Sheet	
Color		-	Ivory White	
Unit length		mm	14102	14102
Unit width		mm	2280	2280
Unit height		mm	2540	2540
Unit weight - shipping		kg	12037	12037
Unit weight - operation		kg	13048	13048
Water connection size		mm	273,0	273,0
Water connection type		-	Victaulic	
<p>(1) Standard Rating Conditions for Air to water chillers according to EN14511:2 Outdoor Heat exchanger inlet dry bulb temperature 35°; Indoor heat exchanger inlet water temperature 12°C, outlet water temperature 7°C. Fouling factor = 0</p> <p>(2) Minimum capacity for the unit operating at Standard Rating Conditions: Operating Ambient Temperature 35°C, Evaporator, water outlet 7°C</p> <p>(3) Seasonal Energy Efficiency Ratio as defined in EN14825, part load condition in cooling for Air to Water units, fan coil application, variable outlet, variable flow.</p> <p>(4) the seasonal space cooling energy efficiency <math>\eta_{s,c}</math> is calculated as defined in Regulation (EU) 2016/2281 the seasonal energy efficiency ratio SEER divided by the conversion coefficient CC (2,5), corrected by contributions accounting for temperature control (0,03).</p> <p>(5) Seasonal energy performance Ratio as defined in Regulation (EU) 2016/2281 for a high temperature process chiller at standard rating conditions defined in EN14511:2</p> <p>(6) minimum flow rate to be reached in variable water flow system (not managed by the unit controller BMS) with unit operating at minimum load.</p> <p>(7) not including filter pressure drop. The installation of the filter is mandatory.</p> <p>(8) sound power level measured in accordance to ISO9614, referred to unit operating at Standard Rating Conditions for Air to water chillers according to EN14511:2 Outdoor Heat exchanger inlet dry bulb temperature 35°; Indoor heat exchanger inlet water temperature 12°C, outlet water temperature 7°C</p> <p>(9) sound power level measured in accordance to ISO3744, referred to unit operating at Standard Rating Conditions for Air to water chillers according to EN14511:2 Outdoor Heat exchanger inlet dry bulb temperature 35°; Indoor heat exchanger inlet water temperature 12°C, outlet water temperature 7°C</p> <p>(10) referred to unit with free discharge on condenser fans.</p> <p>(11) data subject to change. Refer to unit's name plate for actual value.</p> <p> Data certified by Eurovent certification scheme  The above data are referred to the unit without additional optional.  The above data are referred the unit installed in compliancy with installation prescription.  All the data are subject to change without notice. For updated information on project base refer to Chiller Selection Software and unit's certified drawing</p>				

EWAD~TZ- XS C + OPT159 – BRUSHLESS FANS UP TO 700 RPM								
MODEL	notes		C11	C12	H12	C14	C15	H16
Cooling Capacity	(1)	kW	1124	1206	1281	NA		
Power Input	(1)	kW	351	373	398			
EER	(1)	kW/kW	3,20	3,24	3,22			
Minimum capacity	(2)	%	12,5	12,5	12,5			
SEER	(3)	kW/kW	5,46	5,44	5,48			
$\eta_{s,c}$	(4)	%	215	215	216			
Evaporator type		-	Direct Expansion – Shell & Tubes			NA		
Water flow rate	(1)	l/s	53,6	57,5	61,1			
Evaporator pressure drop	(1) (7)	kPa	51,6	32,8	36,6			
Evaporator water volume	(8)	lt	557	1011	1011			
Minimum water rate	(6)	l/s	18,2	22,6	22,6			
Sound Power	(1) (8)	dB(A)	95	96	97	NA		
Sound Pressure @ 1 m	(1) (9)	dB(A)	73	73	74			
Sound Power + opt76b	(1) (8)	dB(A)	92	93	94			
Sound Pressure @ 1 m + opt76b	(1) (9)	dB(A)	70	70	71			
Fan type		-	Direct Propeller			NA		
Fan diameter		mm	800					
Fan rotational speed		RPM	700	700	700			
Fan motor / control		-	EC Brushless Fan					
Number of fans		n	22	24	26			
Power input fans		kW	15,4	16,8	18,2			
Air flow	(10)	l/s	81278	88667	96056			
Refrigerant circuits		n	2	2	2	NA		
Refrigerant type / GWP		-	R134a / GWP = 1430					
Refrigerant Charge	(11)	kg	175	200	220			
Compressor type		-	Single Screw			NA		
Capacity control		-	Stepless – Variable Frequency Drive					
Oil charge		lt	16	16	16			
Casing material		-	Galvanized Steel Sheet					
Color		-	Ivory White					
Unit length		mm	10510	11402	12302			
Unit width		mm	2280	2280	2280			
Unit height		mm	2540	2540	2540			
Unit weight - shipping		kg	9322	10112	10515			
Unit weight - operation		kg	9879	11123	11526			
Water connection size		mm	219,1	273,0	273,0			
Water connection type		-	Victaulic					
<p>(1) Standard Rating Conditions for Air to water chillers according to EN14511:2 Outdoor Heat exchanger inlet dry bulb temperature 35°; Indoor heat exchanger inlet water temperature 12°C, outlet water temperature 7°C. Fouling factor = 0</p> <p>(2) Minimum capacity for the unit operating at Standard Rating Conditions: Operating Ambient Temperature 35°C, Evaporator, water outlet 7°C</p> <p>(3) Seasonal Energy Efficiency Ratio as defined in EN14825, part load condition in cooling for Air to Water units, fan coil application, variable outlet, variable flow.</p> <p>(4) the seasonal space cooling energy efficiency <math>\eta_{s,c}</math> is calculated as defined in Regulation (EU) 2016/2281 the seasonal energy efficiency ratio SEER divided by the conversion coefficient CC (2.5), corrected by contributions accounting for temperature control (0.03).</p> <p>(5) Seasonal energy performance Ratio as defined in Regulation (EU) 2016/2281 for a high temperature process chiller at standard rating conditions defined in EN14511:2</p> <p>(6) minimum flow rate to be reached in variable water flow system (not managed by the unit controller BMS) with unit operating at minimum load.</p> <p>(7) not including filter pressure drop. The installation of the filter is mandatory.</p> <p>(8) sound power level measured in accordance to ISO9614, referred to unit operating at Standard Rating Conditions for Air to water chillers according to EN14511:2 Outdoor Heat exchanger inlet dry bulb temperature 35°; Indoor heat exchanger inlet water temperature 12°C, outlet water temperature 7°C</p> <p>(9) sound power level measured in accordance to ISO3744, referred to unit operating at Standard Rating Conditions for Air to water chillers according to EN14511:2 Outdoor Heat exchanger inlet dry bulb temperature 35°; Indoor heat exchanger inlet water temperature 12°C, outlet water temperature 7°C referred to unit with free discharge on condenser fans.</p> <p>(10) referred to unit with free discharge on condenser fans.</p> <p>(11) data subject to change. Refer to unit's name plate for actual value.</p>								
<p>■ Data certified by Eurovent certification scheme</p> <p>The above data are referred to the unit without additional optional.</p> <p>The above data are referred the unit installed in compliance with installation prescription.</p> <p>All the data are subject to change without notice. For updated information on project base refer to Chiller Selection Software and unit's certified drawing</p>								

EWAD~TZ- XS C + OPT159 – BRUSHLESS FANS UP TO 700 RPM			
MODEL	notes		H17
Cooling Capacity	(1)	kW	NA
Power Input	(1)	kW	
EER	(1)	kW/kW	
Minimum capacity	(2)	%	
SEER	(3)	kW/kW	
$\eta_{s,c}$	(4)	%	
<b>Evaporator</b>			
Evaporator type		-	NA
Water flow rate	(1)	l/s	
Evaporator pressure drop	(1) (7)	kPa	
Evaporator water volume	(8)	lt	
Minimum water rate	(6)	l/s	
<b>Sound</b>			
Sound Power	(1) (8)	dB(A)	NA
Sound Pressure @ 1 m	(1) (9)	dB(A)	
Sound Power +opt76b	(1) (8)	dB(A)	
Sound Pressure @ 1 m +opt76b	(1) (9)	dB(A)	
<b>Fans</b>			
Fan type		-	NA
Fan diameter		mm	
Fan rotational speed		RPM	
Fan motor / control		-	
Number of fans		n	
Power input fans		kW	
Air flow	(10)	l/s	
<b>Refrigerant</b>			
Refrigerant circuits		n	NA
Refrigerant type / GWP		-	
Refrigerant Charge	(11)	kg	
<b>Compressor</b>			
Compressor type		-	NA
Capacity control		-	
Oil charge		lt	
Casing material		-	
Color		-	
Unit length		mm	
Unit width		mm	
Unit height		mm	
Unit weight - shipping		kg	
Unit weight - operation		kg	
Water connection size		mm	
Water connection type		-	
<p>(1) Standard Rating Conditions for Air to water chillers according to EN14511:2 Outdoor Heat exchanger inlet dry bulb temperature 35°; Indoor heat exchanger inlet water temperature 12°C, outlet water temperature 7°C. Fouling factor = 0</p> <p>(2) Minimum capacity for the unit operating at Standard Rating Conditions: Operating Ambient Temperature 35°C, Evaporator, water outlet 7°C</p> <p>(3) Seasonal Energy Efficiency Ratio as defined in EN14825, part load condition in cooling for Air to Water units, fan coil application, variable outlet, variable flow.</p> <p>(4) the seasonal space cooling energy efficiency <math>\eta_{s,c}</math> is calculated as defined in Regulation (EU) 2016/2281 the seasonal energy efficiency ratio SEER divided by the conversion coefficient CC (2.5), corrected by contributions accounting for temperature control (0.03).</p> <p>(5) Seasonal energy performance Ratio as defined in Regulation (EU) 2016/2281 for a high temperature process chiller at standard rating conditions defined in EN14511:2</p> <p>(6) minimum flow rate to be reached in variable water flow system (not managed by the unit controller BMS) with unit operating at minimum load.</p> <p>(7) not including filter pressure drop. The installation of the filter is mandatory.</p> <p>(8) sound power level measured in accordance to ISO9614, referred to unit operating at Standard Rating Conditions for Air to water chillers according to EN14511:2 Outdoor Heat exchanger inlet dry bulb temperature 35°; Indoor heat exchanger inlet water temperature 12°C, outlet water temperature 7°C</p> <p>(9) sound power level measured in accordance to ISO3744, referred to unit operating at Standard Rating Conditions for Air to water chillers according to EN14511:2 Outdoor Heat exchanger inlet dry bulb temperature 35°; Indoor heat exchanger inlet water temperature 12°C, outlet water temperature 7°C</p> <p>(10) referred to unit with free discharge on condenser fans.</p> <p>(11) data subject to change. Refer to unit's name plate for actual value.</p>			
<p> Data certified by Eurovent certification scheme</p> <p>The above data are referred to the unit without additional optional.</p> <p>The above data are referred the unit installed in compliancy with installation prescription.</p> <p>All the data are subject to change without notice. For updated information on project base refer to Chiller Selection Software and unit's certified drawing</p>			

EWAD~TZ- XS C + OPT158 – BRUSHLESS FANS UP TO 900 RPM								
MODEL	notes		C11	C12	H12	C14	C15	H16
Cooling Capacity	(1)	kW	NA			1397	1538	1666
Power Input	(1)	kW				425	471	517
EER	(1)	kW/kW				3,29	3,26	3,23
Minimum capacity	(2)	%				12,5	12,5	12,5
SEER	(3)	kW/kW				5,54	5,49	5,53
$\eta_{s,c}$	(4)	%				219	217	218
Evaporator type								
Evaporator type		-	NA			Direct Expansion – Shell & Tubes		
Water flow rate	(1)	l/s				66,6	73,3	79,4
Evaporator pressure drop	(1) (7)	kPa				42,8	50,8	58,7
Evaporator water volume	(8)	lt				1011	1011	1011
Minimum water rate	(6)	l/s				22,6	22,6	22,6
Sound Power								
Sound Power	(1) (8)	dB(A)	NA			101	101	102
Sound Pressure @ 1 m	(1) (9)	dB(A)				78	78	79
Sound Power + opt76b	(1) (8)	dB(A)				100	100	100
Sound Pressure @ 1 m + opt76b	(1) (9)	dB(A)				77	77	77
Fan type								
Fan type		-	NA			Direct Propeller		
Fan diameter		mm				800		
Fan rotational speed		RPM				900	900	900
Fan motor / control		-				EC Brushless Fan		
Number of fans		n				24	26	28
Power input fans		kW				34,6	37,4	40,3
Air flow	(10)	l/s				126389	136111	136111
Refrigerant circuits								
Refrigerant circuits		n	NA			2	2	2
Refrigerant type / GWP		-				R134a / GWP = 1430		
Refrigerant Charge	(11)	kg				200	220	250
Compressor type								
Compressor type		-	NA			Single Screw		
Capacity control		-				Stepless – Variable Frequency Drive		
Oil charge		lt				25	25	25
Casing material		-				Galvanized Steel Sheet		
Color		-				Ivory White		
Unit length		mm				11402	12302	13202
Unit width		mm				2280	2280	2280
Unit height		mm				2540	2540	2540
Unit weight - shipping		kg				10716	11134	11564
Unit weight - operation		kg				11727	12145	12575
Water connection size		mm				273,0	273,0	273,0
Water connection type		-				Victaulic		
<p>(1) Standard Rating Conditions for Air to water chillers according to EN14511:2 Outdoor Heat exchanger inlet dry bulb temperature 35°; Indoor heat exchanger inlet water temperature 12°C, outlet water temperature 7°C. Fouling factor = 0</p> <p>(2) Minimum capacity for the unit operating at Standard Rating Conditions: Operating Ambient Temperature 35°C, Evaporator, water outlet 7°C</p> <p>(3) Seasonal Energy Efficiency Ratio as defined in EN14825, part load condition in cooling for Air to Water units, fan coil application, variable outlet, variable flow.</p> <p>(4) the seasonal space cooling energy efficiency <math>\eta_{s,c}</math> is calculated as defined in Regulation (EU) 2016/2281 the seasonal energy efficiency ratio SEER divided by the conversion coefficient CC (2.5), corrected by contributions accounting for temperature control (0.03).</p> <p>(5) Seasonal energy performance Ratio as defined in Regulation (EU) 2016/2281 for a high temperature process chiller at standard rating conditions defined in EN14511:2</p> <p>(6) minimum flow rate to be reached in variable water flow system (not managed by the unit controller BMS) with unit operating at minimum load.</p> <p>(7) not including filter pressure drop. The installation of the filter is mandatory.</p> <p>(8) sound power level measured in accordance to ISO9614, referred to unit operating at Standard Rating Conditions for Air to water chillers according to EN14511:2 Outdoor Heat exchanger inlet dry bulb temperature 35°; Indoor heat exchanger inlet water temperature 12°C, outlet water temperature 7°C</p> <p>(9) sound power level measured in accordance to ISO3744, referred to unit operating at Standard Rating Conditions for Air to water chillers according to EN14511:2 Outdoor Heat exchanger inlet dry bulb temperature 35°; Indoor heat exchanger inlet water temperature 12°C, outlet water temperature 7°C referred to unit with free discharge on condenser fans.</p> <p>(10) referred to unit with free discharge on condenser fans.</p> <p>(11) data subject to change. Refer to unit's name plate for actual value.</p>								
<p>■ Data certified by Eurovent certification scheme</p> <p>The above data are referred to the unit without additional optional.</p> <p>The above data are referred the unit installed in compliancy with installation prescription.</p> <p>All the data are subject to change without notice. For updated information on project base refer to Chiller Selection Software and unit's certified drawing</p>								



EWAD~TZ- XS C + OPT158 – BRUSHLESS FANS UP TO 900 RPM			
MODEL	notes		H17
Cooling Capacity	(1)	kW	1778
Power Input	(1)	kW	567
EER	(1)	kW/kW	3,14
Minimum capacity	(2)	%	12,5
SEER	(3)	kW/kW	5,55
$\eta_{s,c}$	(4)	%	219
Evaporator type			
		-	Direct Expansion – Shell & Tubes
Water flow rate	(1)	l/s	84,8
Evaporator pressure drop	(1) (7)	kPa	66,0
Evaporator water volume	(8)	lt	1011
Minimum water rate	(6)	l/s	22,6
Sound Power			
Sound Power	(1) (8)	dB(A)	102
Sound Pressure @ 1 m	(1) (9)	dB(A)	79
Sound Power +opt76b	(1) (8)	dB(A)	101
Sound Pressure @ 1 m +opt76b	(1) (9)	dB(A)	77
Fan type			
		-	Direct Propeller
Fan diameter		mm	800
Fan rotational speed		RPM	900
Fan motor / control		-	EC Brushless Fan
Number of fans		n	30
Power input fans		kW	43,2
Air flow	(10)	l/s	145833
Refrigerant circuits			
		n	2
Refrigerant type / GWP			
		-	R134a / GWP = 1430
Refrigerant Charge	(11)	kg	270
Compressor type			
		-	Single Screw
Capacity control			
		-	Stepless – Variable Frequency Drive
Oil charge		lt	25
Casing material			
		-	Galvanized Steel Sheet
Color			
		-	Ivory White
Unit length		mm	14104
Unit width		mm	2280
Unit height		mm	2540
Unit weight - shipping		kg	12037
Unit weight - operation		kg	13048
Water connection size		mm	273,0
Water connection type			
		-	Victaulic
<p>(1) Standard Rating Conditions for Air to water chillers according to EN14511:2 Outdoor Heat exchanger inlet dry bulb temperature 35°; Indoor heat exchanger inlet water temperature 12°C, outlet water temperature 7°C. Fouling factor = 0</p> <p>(2) Minimum capacity for the unit operating at Standard Rating Conditions: Operating Ambient Temperature 35°C, Evaporator, water outlet 7°C</p> <p>(3) Seasonal Energy Efficiency Ratio as defined in EN14825, part load condition in cooling for Air to Water units, fan coil application, variable outlet, variable flow.</p> <p>(4) the seasonal space cooling energy efficiency <math>\eta_{s,c}</math> is calculated as defined in Regulation (EU) 2016/2281 the seasonal energy efficiency ratio SEER divided by the conversion coefficient CC (2.5), corrected by contributions accounting for temperature control (0.03).</p> <p>(5) Seasonal energy performance Ratio as defined in Regulation (EU) 2016/2281 for a high temperature process chiller at standard rating conditions defined in EN14511:2</p> <p>(6) minimum flow rate to be reached in variable water flow system (not managed by the unit controller BMS) with unit operating at minimum load.</p> <p>(7) not including filter pressure drop. The installation of the filter is mandatory.</p> <p>(8) sound power level measured in accordance to ISO9614, referred to unit operating at Standard Rating Conditions for Air to water chillers according to EN14511:2 Outdoor Heat exchanger inlet dry bulb temperature 35°; Indoor heat exchanger inlet water temperature 12°C, outlet water temperature 7°C</p> <p>(9) sound power level measured in accordance to ISO3744, referred to unit operating at Standard Rating Conditions for Air to water chillers according to EN14511:2 Outdoor Heat exchanger inlet dry bulb temperature 35°; Indoor heat exchanger inlet water temperature 12°C, outlet water temperature 7°C</p> <p>(10) referred to unit with free discharge on condenser fans.</p> <p>(11) data subject to change. Refer to unit's name plate for actual value.</p>			
<p>■ Data certified by Eurovent certification scheme</p> <p>The above data are referred to the unit without additional optional.</p> <p>The above data are referred the unit installed in compliancy with installation prescription.</p> <p>All the data are subject to change without notice. For updated information on project base refer to Chiller Selection Software and unit's certified drawing</p>			

EWAD~TZ- XR C + OPT159 – BRUSHLESS FANS UP TO 700 RPM								
MODEL	notes		C11	C12	H12	C14	C15	H16
Cooling Capacity	(1)	kW	1123	1205	1279	1363	1500	1626
Power Input	(1)	kW	353	374	399	447	497	543
EER	(1)	kW/kW	3,18	3,22	3,20	3,05	3,02	2,99
Minimum capacity	(2)	%	12,5	12,5	12,5	12,5	12,5	12,5
SEER	(3)	kW/kW	5,44	5,41	5,42	5,75	5,44	5,52
$\eta_{s,c}$	(4)	%	215	213	214	211	215	218
Evaporator type								
		-	Direct Expansion – Shell & Tubes					
Water flow rate	(1)	l/s	53,5	57,4	61,0	65,0	71,5	77,5
Evaporator pressure drop	(1) (7)	kPa	51,5	32,8	36,5	40,9	48,6	56,2
Evaporator water volume	(8)	lt	557	1011	1011	1011	1011	1011
Minimum water rate	(6)	l/s	18,2	22,6	22,6	22,6	22,6	22,6
Sound Power								
	(1) (8)	dB(A)	92	93	94	93	94	95
Sound Pressure @ 1 m								
	(1) (9)	dB(A)	70	70	71	71	71	71
Fan type								
		-	Direct Propeller					
Fan diameter		mm	800					
Fan rotational speed		RPM	700					
Fan motor / control								
		-	EC Brushless Fan					
Number of fans		n	22	24	26	24	26	28
Power input fans		kW	15,4	16,8	18,2	16,8	18,2	19,6
Air flow	(10)	l/s	81278	88667	96056	88667	96056	103444
Refrigerant circuits								
		n	2	2	2	2	2	2
Refrigerant type / GWP								
		-	R134a / GWP = 1430					
Refrigerant Charge								
	(11)	kg	175	200	220	200	220	250
Compressor type								
		-	Single Screw					
Capacity control								
		-	Stepless – Variable Frequency Drive					
Oil charge								
		lt	16	16	16	25	25	25
Casing material								
		-	Galvanized Steel Sheet					
Color								
		-	Ivory White					
Unit length		mm	10510	11402	12302	11402	12302	13202
Unit width		mm	2280	2280	2280	2280	2280	2280
Unit height		mm	2540	2540	2540	2540	2540	2540
Unit weight - shipping		kg	9322	10112	10515	10716	11134	11564
Unit weight - operation		kg	9879	11123	11526	11727	12145	12575
Water connection size								
		mm	219,1	273,0	273,0	273,0	273,0	273,0
Water connection type								
		-	Victaulic					
<p>(1) Standard Rating Conditions for Air to water chillers according to EN14511:2 Outdoor Heat exchanger inlet dry bulb temperature 35°; Indoor heat exchanger inlet water temperature 12°C, outlet water temperature 7°C. Fouling factor = 0</p> <p>(2) Minimum capacity for the unit operating at Standard Rating Conditions: Operating Ambient Temperature 35°C, Evaporator, water outlet 7°C</p> <p>(3) Seasonal Energy Efficiency Ratio as defined in EN14825, part load condition in cooling for Air to Water units, fan coil application, variable outlet, variable flow.</p> <p>(4) the seasonal space cooling energy efficiency <math>\eta_{s,c}</math> is calculated as defined in Regulation (EU) 2016/2281 the seasonal energy efficiency ratio SEER divided by the conversion coefficient CC (2.5), corrected by contributions accounting for temperature control (0.03).</p> <p>(5) Seasonal energy performance Ratio as defined in Regulation (EU) 2016/2281 for a high temperature process chiller at standard rating conditions defined in EN14511:2</p> <p>(6) minimum flow rate to be reached in variable water flow system (not managed by the unit controller BMS) with unit operating at minimum load.</p> <p>(7) not including filter pressure drop. The installation of the filter is mandatory.</p> <p>(8) sound power level measured in accordance to ISO9614, referred to unit operating at Standard Rating Conditions for Air to water chillers according to EN14511:2 Outdoor Heat exchanger inlet dry bulb temperature 35°; Indoor heat exchanger inlet water temperature 12°C, outlet water temperature 7°C</p> <p>(9) sound power level measured in accordance to ISO3744, referred to unit operating at Standard Rating Conditions for Air to water chillers according to EN14511:2 Outdoor Heat exchanger inlet dry bulb temperature 35°; Indoor heat exchanger inlet water temperature 12°C, outlet water temperature 7°C</p> <p>(10) referred to unit with free discharge on condenser fans.</p> <p>(11) data subject to change. Refer to unit's name plate for actual value.</p>								
<p>Data certified by Eurovent certification scheme</p> <p>The above data are referred to the unit without additional optional.</p> <p>The above data are referred the unit installed in compliancy with installation prescription.</p> <p>All the data are subject to change without notice. For updated information on project base refer to Chiller Selection Software and unit's certified drawing</p>								

EWAD~TZ- XR C + OPT159 – BRUSHLESS FANS UP TO 700 RPM			
MODEL	notes		H17
Cooling Capacity	(1)	kW	1737
Power Input	(1)	kW	594
EER	(1)	kW/kW	2,92
Minimum capacity	(2)	%	12,5
SEER	(3)	kW/kW	5,42
$\eta_{s,c}$	(4)	%	214
Evaporator type			
		-	Direct Expansion – Shell & Tubes
Water flow rate	(1)	l/s	82,8
Evaporator pressure drop	(1) (7)	kPa	63,3
Evaporator water volume	(8)	lt	1011
Minimum water rate	(6)	l/s	22,6
Sound Power			
	(1) (8)	dB(A)	95
Sound Pressure @ 1 m	(1) (9)	dB(A)	72
Fan type			
		-	Direct Propeller
Fan diameter		mm	800
Fan rotational speed		RPM	700
Fan motor / control		-	EC Brushless Fan
Number of fans		n	30
Power input fans		kW	21,0
Air flow	(10)	l/s	110833
Refrigerant circuits			
		n	2
Refrigerant type / GWP		-	R134a / GWP = 1430
Refrigerant Charge	(11)	kg	270
Compressor type			
		-	Single Screw
Capacity control		-	Stepless – Variable Frequency Drive
Oil charge		lt	25
Casing material		-	Galvanized Steel Sheet
Color		-	Ivory White
Unit length		mm	14104
Unit width		mm	2280
Unit height		mm	2540
Unit weight - shipping		kg	12037
Unit weight - operation		kg	13048
Water connection size		mm	273,0
Water connection type		-	Victaulic
<p>(1) Standard Rating Conditions for Air to water chillers according to EN14511:2 Outdoor Heat exchanger inlet dry bulb temperature 35°; Indoor heat exchanger inlet water temperature 12°C, outlet water temperature 7°C. Fouling factor = 0</p> <p>(2) Minimum capacity for the unit operating at Standard Rating Conditions: Operating Ambient Temperature 35°C, Evaporator, water outlet 7°C</p> <p>(3) Seasonal Energy Efficiency Ratio as defined in EN14825, part load condition in cooling for Air to Water units, fan coil application, variable outlet, variable flow.</p> <p>(4) the seasonal space cooling energy efficiency <math>\eta_{s,c}</math> is calculated as defined in Regulation (EU) 2016/2281 the seasonal energy efficiency ratio SEER divided by the conversion coefficient CC (2.5), corrected by contributions accounting for temperature control (0.03).</p> <p>(5) Seasonal energy performance Ratio as defined in Regulation (EU) 2016/2281 for a high temperature process chiller at standard rating conditions defined in EN14511:2</p> <p>(6) minimum flow rate to be reached in variable water flow system (not managed by the unit controller BMS) with unit operating at minimum load.</p> <p>(7) not including filter pressure drop. The installation of the filter is mandatory.</p> <p>(8) sound power level measured in accordance to ISO9614, referred to unit operating at Standard Rating Conditions for Air to water chillers according to EN14511:2 Outdoor Heat exchanger inlet dry bulb temperature 35°; Indoor heat exchanger inlet water temperature 12°C, outlet water temperature 7°C</p> <p>(9) sound power level measured in accordance to ISO3744, referred to unit operating at Standard Rating Conditions for Air to water chillers according to EN14511:2 Outdoor Heat exchanger inlet dry bulb temperature 35°; Indoor heat exchanger inlet water temperature 12°C, outlet water temperature 7°C</p> <p>(10) referred to unit with free discharge on condenser fans.</p> <p>(11) data subject to change. Refer to unit's name plate for actual value.</p>			
<p> Data certified by Eurovent certification scheme</p> <p>The above data are referred to the unit without additional optional.</p> <p>The above data are referred the unit installed in compliancy with installation prescription.</p> <p>All the data are subject to change without notice. For updated information on project base refer to Chiller Selection Software and unit's certified drawing</p>			

EWAH~TZ- SS C – standard unit								
MODEL	notes		710	770	880	940	990	H10
Phases		n	3					
Frequency		Hz	50					
Voltage	(2)	V	400					
Voltage Tolerances min/max		%	-10 / +10					
Nominal Running Current	(1)	A	408,6	433,3	493,5	521,5	549,9	579,6
Max. running current	(3)	A	674	711	879	893	907	949
Max. current for wire sizing	(4)	A	741	782	967	982	997	1044
Maximum starting current	(5)	A	0	0	0	0	0	0
Fan starting method	(6)	-	D.O.L.					
Max running current per fan	(6)	A	4					
Total fans running current	(6)	A	56	56	64	72	80	88
Compressor starting method			Variable Frequency Drive					
Max. running current Compressor #1	(6)	A	246	262	291	308	326	345
Max. running current Compressor #2	(6)	A	246	262	291	308	326	345
Main switch size	(6)	A	800	800	1000	1000	1250	1250
Terminal connection	(6)	-	Cables	Cables	Bars	Bars	Bars	Bars
Cable per phase	(6)	-	2x240 mm <sup>2</sup>	2x240 mm <sup>2</sup>	2x300 mm <sup>2</sup>	2x300 mm <sup>2</sup>	2x400 mm <sup>2</sup>	2x400 mm <sup>2</sup>
Short circuit current Icw 1 sec.	(6)	kA	20	20	25	25	25	25
<p>(1) Standard Rating Conditions for Air to water chillers according to EN14511:2 Outdoor Heat exchanger inlet dry bulb temperature 35°; Indoor heat exchanger inlet water temperature 12°C, outlet water temperature 7°C. Fouling factor = 0</p> <p>(2) Voltage unbalance between phases must be within ± 3%.</p> <p>(3) Maximum running current is based on max compressor absorbed current in its envelope and max fans absorbed current.</p> <p>(4) Based on minimum allowed voltage → Max. current for wire sizing = Max. Running current x 1,1</p> <p>(5) In case of inverter driven compressor, the starting current is zero</p> <p>(6) It may change in case of unit with options or customized unit. Refer to dedicated unit's wiring diagram.</p> <p>The data are referred to the unit without additional options. All data are subject to change without notice. For updated information on project base refer to unit specific wiring diagram and unit's nameplate data.</p>								

EWAH~TZ- SS C – standard unit								
MODEL	notes		C11	C12	C13	C14	C15	C16
Phases		n	3					
Frequency		Hz	50					
Voltage	(2)	V	400					
Voltage Tolerances min/max		%	-10 / +10					
Nominal Running Current	(1)	A	612,7	668,8	718,8	780,9	848,9	934,8
Max. running current	(3)	A	1058	1072	1144	1228	1315	1333
Max. current for wire sizing	(4)	A	1164	1179	1259	1351	1447	1467
Maximum starting current	(5)	A	0	0	0	0	0	0
Fan starting method	(6)	-	D.O.L.					
Max running current per fan	(6)	A	4					
Total fans running current	(6)	A	96	104	96	104	112	120
Compressor starting method			Variable Frequency Drive					
Max. running current Compressor #1	(6)	A	367	415	419	451	484	518
Max. running current Compressor #2	(6)	A	367	415	419	451	484	518
Main switch size	(6)	A	1250	1250	1600	1600	1600	1600
Terminal connection	(6)	-	Bars	Bars	Bars	Bars	Bars	Bars
Cable per phase	(6)	-	2x400 mm <sup>2</sup>	2x400 mm <sup>2</sup>	2x500 mm <sup>2</sup>	2x500 mm <sup>2</sup>	2x500 mm <sup>2</sup>	2x500 mm <sup>2</sup>
Short circuit current I <sub>cw</sub> 1 sec.	(6)	kA	25	25	25	25	25	25
<p>(1) Standard Rating Conditions for Air to water chillers according to EN14511:2 Outdoor Heat exchanger inlet dry bulb temperature 35°; Indoor heat exchanger inlet water temperature 12°C, outlet water temperature 7°C. Fouling factor = 0</p> <p>(2) Voltage unbalance between phases must be within ± 3%.</p> <p>(3) Maximum running current is based on max compressor absorbed current in its envelope and max fans absorbed current.</p> <p>(4) Based on minimum allowed voltage → Max. current for wire sizing = Max. Running current x 1,1</p> <p>(5) In case of inverter driven compressor, the starting current is zero</p> <p>(6) It may change in case of unit with options or customized unit. Refer to dedicated unit's wiring diagram.</p> <p>The data are referred to the unit without additional options. All data are subject to change without notice. For updated information on project base refer to unit specific wiring diagram and unit's nameplate data.</p>								

EWAH~TZ- SL C – standard unit								
MODEL	notes		710	770	880	940	990	H10
Phases		n	3					
Frequency		Hz	50					
Voltage	(2)	V	400					
Voltage Tolerances min/max		%	-10 / +10					
Nominal Running Current	(1)	A	408,6	433,3	493,5	521,5	549,9	579,6
Max. running current	(3)	A	674	711	879	893	907	949
Max. current for wire sizing	(4)	A	741	782	967	982	997	1044
Maximum starting current	(5)	A	0	0	0	0	0	0
Fan starting method	(6)	-	D.O.L.					
Max running current per fan	(6)	A	4					
Total fans running current	(6)	A	56	56	64	72	80	88
Compressor starting method			Variable Frequency Drive					
Max. running current Compressor #1	(6)	A	246	262	291	308	326	345
Max. running current Compressor #2	(6)	A	246	262	291	308	326	345
Main switch size	(6)	A	800	800	1000	1000	1250	1250
Terminal connection	(6)	-	Cables	Cables	Bars	Bars	Bars	Bars
Cable per phase	(6)	-	2x240 mm <sup>2</sup>	2x240 mm <sup>2</sup>	2x300 mm <sup>2</sup>	2x300 mm <sup>2</sup>	2x400 mm <sup>2</sup>	2x400 mm <sup>2</sup>
Short circuit current I <sub>cw</sub> 1 sec.	(6)	kA	20	20	25	25	25	25
<p>(1) Standard Rating Conditions for Air to water chillers according to EN14511:2 Outdoor Heat exchanger inlet dry bulb temperature 35°; Indoor heat exchanger inlet water temperature 12°C, outlet water temperature 7°C. Fouling factor = 0</p> <p>(2) Voltage unbalance between phases must be within ± 3%.</p> <p>(3) Maximum running current is based on max compressor absorbed current in its envelope and max fans absorbed current.</p> <p>(4) Based on minimum allowed voltage → Max. current for wire sizing = Max. Running current x 1,1</p> <p>(5) In case of inverter driven compressor, the starting current is zero</p> <p>(6) It may change in case of unit with options or customized unit. Refer to dedicated unit's wiring diagram.</p> <p>The data are referred to the unit without additional options. All data are subject to change without notice. For updated information on project base refer to unit specific wiring diagram and unit's nameplate data.</p>								

EWAH~TZ- SL C – standard unit								
MODEL	notes		C11	C12	C13	C14	C15	C16
Phases		n	3					
Frequency		Hz	50					
Voltage	(2)	V	400					
Voltage Tolerances min/max		%	-10 / +10					
Nominal Running Current	(1)	A	612,7	668,8	718,8	780,9	848,9	934,8
Max. running current	(3)	A	1058	1072	1144	1228	1315	1333
Max. current for wire sizing	(4)	A	1164	1179	1259	1351	1447	1467
Maximum starting current	(5)	A	0	0	0	0	0	0
Fan starting method	(6)	-	D.O.L.					
Max running current per fan	(6)	A	4					
Total fans running current	(6)	A	96	104	96	104	112	120
Compressor starting method			Variable Frequency Drive					
Max. running current Compressor #1	(6)	A	367	415	419	451	484	518
Max. running current Compressor #2	(6)	A	367	415	419	451	484	518
Main switch size	(6)	A	1250	1250	1600	1600	1600	1600
Terminal connection	(6)	-	Bars	Bars	Bars	Bars	Bars	Bars
Cable per phase	(6)	-	2x400 mm <sup>2</sup>	2x400 mm <sup>2</sup>	2x500 mm <sup>2</sup>	2x500 mm <sup>2</sup>	2x500 mm <sup>2</sup>	2x500 mm <sup>2</sup>
Short circuit current I <sub>cw</sub> 1 sec.	(6)	kA	25	25	25	25	25	25
<p>(1) Standard Rating Conditions for Air to water chillers according to EN14511:2 Outdoor Heat exchanger inlet dry bulb temperature 35°; Indoor heat exchanger inlet water temperature 12°C, outlet water temperature 7°C. Fouling factor = 0</p> <p>(2) Voltage unbalance between phases must be within ± 3%.</p> <p>(3) Maximum running current is based on max compressor absorbed current in its envelope and max fans absorbed current.</p> <p>(4) Based on minimum allowed voltage → Max. current for wire sizing = Max. Running current x 1,1</p> <p>(5) In case of inverter driven compressor, the starting current is zero</p> <p>(6) It may change in case of unit with options or customized unit. Refer to dedicated unit's wiring diagram.</p> <p>The data are referred to the unit without additional options. All data are subject to change without notice. For updated information on project base refer to unit specific wiring diagram and unit's nameplate data.</p>								



EWAH~TZ- SR C – standard unit								
MODEL	notes		710	770	880	940	990	H10
Phases		n	3					
Frequency		Hz	50					
Voltage	(2)	V	400					
Voltage Tolerances min/max		%	-10 / +10					
Nominal Running Current	(1)	A	414,9	446,8	505,2	529,7	554,4	581,0
Max. running current	(3)	A	674	711	879	893	907	949
Max. current for wire sizing	(4)	A	741	782	967	982	997	1044
Maximum starting current	(5)	A	0	0	0	0	0	0
Fan starting method	(6)	-	Inverter driven motor					
Max running current per fan	(6)	A	2,6					
Total fans running current	(6)	A	36,4	36,4	41,6	46,8	52,0	57,2
Compressor starting method			Variable Frequency Drive					
Max. running current Compressor #1	(6)	A	246	262	291	308	326	345
Max. running current Compressor #2	(6)	A	246	262	291	308	326	345
Main switch size	(6)	A	800	800	1000	1000	1250	1250
Terminal connection	(6)	-	Cables	Cables	Bars	Bars	Bars	Bars
Cable per phase	(6)	-	2x240 mm <sup>2</sup>	2x240 mm <sup>2</sup>	2x300 mm <sup>2</sup>	2x300 mm <sup>2</sup>	2x400 mm <sup>2</sup>	2x400 mm <sup>2</sup>
Short circuit current I <sub>cw</sub> 1 sec.	(6)	kA	20	20	25	25	25	25
<p>(1) Standard Rating Conditions for Air to water chillers according to EN14511:2 Outdoor Heat exchanger inlet dry bulb temperature 35°; Indoor heat exchanger inlet water temperature 12°C, outlet water temperature 7°C. Fouling factor = 0</p> <p>(2) Voltage unbalance between phases must be within ± 3%.</p> <p>(3) Maximum running current is based on max compressor absorbed current in its envelope and max fans absorbed current.</p> <p>(4) Based on minimum allowed voltage → Max. current for wire sizing = Max. Running current x 1,1</p> <p>(5) In case of inverter driven compressor, the starting current is zero</p> <p>(6) It may change in case of unit with options or customized unit. Refer to dedicated unit's wiring diagram.</p> <p>The data are referred to the unit without additional options. All data are subject to change without notice. For updated information on project base refer to unit specific wiring diagram and unit's nameplate data.</p>								

<b>EWAH~TZ- SR C – standard unit</b>								
<b>MODEL</b>	<b>notes</b>		<b>C11</b>	<b>C12</b>	<b>C13</b>	<b>C14</b>	<b>C15</b>	<b>C16</b>
Phases		n	3					
Frequency		Hz	50					
Voltage	(2)	V	400					
Voltage Tolerances min/max		%	-10 / +10					
<b>Nominal Running Current</b>								
Nominal Running Current	(1)	A	611,1	667,2	736,4	796,5	863,9	952,0
<b>Max. running current</b>								
Max. running current	(3)	A	1058	1072	1144	1228	1315	1333
<b>Max. current for wire sizing</b>								
Max. current for wire sizing	(4)	A	1164	1179	1259	1351	1447	1467
<b>Maximum starting current</b>								
Maximum starting current	(5)	A	0	0	0	0	0	0
<b>Fan starting method</b>								
Fan starting method	(6)	-	Inverter driven motor					
<b>Max running current per fan</b>								
Max running current per fan	(6)	A	2,6					
<b>Total fans running current</b>								
Total fans running current	(6)	A	62,4	67,6	62,4	67,6	72,8	78,0
<b>Compressor starting method</b>								
Compressor starting method			Variable Frequency Drive					
<b>Max. running current Compressor #1</b>								
Max. running current Compressor #1	(6)	A	367	415	419	451	484	518
<b>Max. running current Compressor #2</b>								
Max. running current Compressor #2	(6)	A	367	415	419	451	484	518
<b>Main switch size</b>								
Main switch size	(6)	A	1250	1250	1600	1600	1600	1600
<b>Terminal connection</b>								
Terminal connection	(6)	-	Bars	Bars	Bars	Bars	Bars	Bars
<b>Cable per phase</b>								
Cable per phase	(6)	-	2x400 mm <sup>2</sup>	2x400 mm <sup>2</sup>	2x500 mm <sup>2</sup>	2x500 mm <sup>2</sup>	2x500 mm <sup>2</sup>	2x500 mm <sup>2</sup>
<b>Short circuit current Icw 1 sec.</b>								
Short circuit current Icw 1 sec.	(6)	kA	25	25	25	25	25	25
<p>(1) Standard Rating Conditions for Air to water chillers according to EN14511:2 Outdoor Heat exchanger inlet dry bulb temperature 35°; Indoor heat exchanger inlet water temperature 12°C, outlet water temperature 7°C. Fouling factor = 0</p> <p>(2) Voltage unbalance between phases must be within ± 3%.</p> <p>(3) Maximum running current is based on max compressor absorbed current in its envelope and max fans absorbed current.</p> <p>(4) Based on minimum allowed voltage → Max. current for wire sizing = Max. Running current x 1,1</p> <p>(5) In case of inverter driven compressor, the starting current is zero</p> <p>(6) It may change in case of unit with options or customized unit. Refer to dedicated unit's wiring diagram.</p> <p>The data are referred to the unit without additional options. All data are subject to change without notice. For updated information on project base refer to unit specific wiring diagram and unit's nameplate data.</p>								

EWAH~TZ- XS C – standard unit								
MODEL	notes		670	780	840	950	C10	C11
Phases		n	3					
Frequency		Hz	50					
Voltage	(2)	V	400					
Voltage Tolerances min/max		%	-10 / +10					
Nominal Running Current	(1)	A	373,9	431,3	459,1	513,1	544,2	604,8
Max. running current	(3)	A	711	698	767	914	927	1072
Max. current for wire sizing	(4)	A	782	767	844	1005	1020	1179
Maximum starting current	(5)	A	0	0	0	0	0	0
Fan starting method	(6)	-	Inverter driven motor					
Max running current per fan	(6)	A	2,6					
Total fans running current	(6)	A	36,4	41,6	46,8	57,2	62,4	67,6
Compressor starting method			Variable Frequency Drive					
Max. running current Compressor #1	(6)	A	236	248	276	291	326	367
Max. running current Compressor #2	(6)	A	236	248	276	291	326	367
Main switch size	(6)	A	800	800	1000	1000	1250	1250
Terminal connection	(6)	-	Cables	Cables	Bars	Bars	Bars	Bars
Cable per phase	(6)	-	2x240 mm <sup>2</sup>	2x240 mm <sup>2</sup>	2x300 mm <sup>2</sup>	2x300 mm <sup>2</sup>	2x400 mm <sup>2</sup>	2x400 mm <sup>2</sup>
Short circuit current Icw 1 sec.	(6)	kA	20	20	25	25	25	25
<p>(1) Standard Rating Conditions for Air to water chillers according to EN14511:2 Outdoor Heat exchanger inlet dry bulb temperature 35°; Indoor heat exchanger inlet water temperature 12°C, outlet water temperature 7°C. Fouling factor = 0</p> <p>(2) Voltage unbalance between phases must be within ± 3%.</p> <p>(3) Maximum running current is based on max compressor absorbed current in its envelope and max fans absorbed current.</p> <p>(4) Based on minimum allowed voltage → Max. current for wire sizing = Max. Running current x 1,1</p> <p>(5) In case of inverter driven compressor, the starting current is zero</p> <p>(6) It may change in case of unit with options or customized unit. Refer to dedicated unit's wiring diagram.</p> <p>The data are referred to the unit without additional options. All data are subject to change without notice. For updated information on project base refer to unit specific wiring diagram and unit's nameplate data.</p>								

EWAH~TZ- XS C – standard unit						
MODEL	notes		C12	C13	C14	C15
Phases		n	3			
Frequency		Hz	50			
Voltage	(2)	V	400			
Voltage Tolerances min/max		%	-10 / +10			
<b>Nominal Running Current</b>						
Nominal Running Current	(1)	A	660,3	717,4	778,2	848,9
<b>Max. running current</b>						
Max. running current	(3)	A	1038	1158	1242	1269
<b>Max. current for wire sizing</b>						
Max. current for wire sizing	(4)	A	1142	1274	1366	1396
<b>Maximum starting current</b>						
Maximum starting current	(5)	A	0	0	0	0
<b>Fan starting method</b>						
Fan starting method	(6)	-	Inverter driven motor			
<b>Max running current per fan</b>						
Max running current per fan	(6)	A	4			
<b>Total fans running current</b>						
Total fans running current	(6)	A	96	104	112	120
<b>Compressor starting method</b>						
Compressor starting method			Variable Frequency Drive			
<b>Max. running current Compressor #1</b>						
Max. running current Compressor #1	(6)	A	388	419	451	484
<b>Max. running current Compressor #2</b>						
Max. running current Compressor #2	(6)	A	388	419	451	484
<b>Main switch size</b>						
Main switch size	(6)	A	1250	1600	1600	1600
<b>Terminal connection</b>						
Terminal connection	(6)	-	Bars	Bars	Bars	Bars
<b>Cable per phase</b>						
Cable per phase	(6)	-	2x400 mm <sup>2</sup>	2x500 mm <sup>2</sup>	2x500 mm <sup>2</sup>	2x500 mm <sup>2</sup>
<b>Short circuit current I<sub>cw</sub> 1 sec.</b>						
Short circuit current I <sub>cw</sub> 1 sec.	(6)	kA	25	25	25	25
<p>(1) Standard Rating Conditions for Air to water chillers according to EN14511:2 Outdoor Heat exchanger inlet dry bulb temperature 35°; Indoor heat exchanger inlet water temperature 12°C, outlet water temperature 7°C. Fouling factor = 0</p> <p>(2) Voltage unbalance between phases must be within ± 3%.</p> <p>(3) Maximum running current is based on max compressor absorbed current in its envelope and max fans absorbed current.</p> <p>(4) Based on minimum allowed voltage → Max. current for wire sizing = Max. Running current x 1,1</p> <p>(5) In case of inverter driven compressor, the starting current is zero</p> <p>(6) It may change in case of unit with options or customized unit. Refer to dedicated unit's wiring diagram.</p> <p>The data are referred to the unit without additional options. All data are subject to change without notice. For updated information on project base refer to unit specific wiring diagram and unit's nameplate data.</p>						

<b>EWAH~TZ- XL C – standard unit</b>								
<b>MODEL</b>	<b>notes</b>		<b>670</b>	<b>780</b>	<b>840</b>	<b>950</b>	<b>C10</b>	<b>C11</b>
Phases		n	3					
Frequency		Hz	50					
Voltage	(2)	V	400					
Voltage Tolerances min/max		%	-10 / +10					
<b>Nominal Running Current</b>								
Nominal Running Current	(1)	A	373,9	431,3	459,1	513,1	544,2	604,8
<b>Max. running current</b>								
Max. running current	(3)	A	711	698	767	914	927	1072
<b>Max. current for wire sizing</b>								
Max. current for wire sizing	(4)	A	782	767	844	1005	1020	1179
<b>Maximum starting current</b>								
Maximum starting current	(5)	A	0	0	0	0	0	0
<b>Fan starting method</b>								
Fan starting method	(6)	-	Inverter driven motor					
<b>Max running current per fan</b>								
Max running current per fan	(6)	A	2,6					
<b>Total fans running current</b>								
Total fans running current	(6)	A	36,4	41,6	46,8	57,2	62,4	67,6
<b>Compressor starting method</b>								
Compressor starting method			Variable Frequency Drive					
<b>Max. running current Compressor #1</b>								
Max. running current Compressor #1	(6)	A	236	248	276	291	326	367
<b>Max. running current Compressor #2</b>								
Max. running current Compressor #2	(6)	A	236	248	276	291	326	367
<b>Main switch size</b>								
Main switch size	(6)	A	800	800	1000	1000	1250	1250
<b>Terminal connection</b>								
Terminal connection	(6)	-	Cables	Cables	Bars	Bars	Bars	Bars
<b>Cable per phase</b>								
Cable per phase	(6)	-	2x240 mm <sup>2</sup>	2x240 mm <sup>2</sup>	2x300 mm <sup>2</sup>	2x300 mm <sup>2</sup>	2x400 mm <sup>2</sup>	2x400 mm <sup>2</sup>
<b>Short circuit current Icw 1 sec.</b>								
Short circuit current Icw 1 sec.	(6)	kA	20	20	25	25	25	25
<p>(1) Standard Rating Conditions for Air to water chillers according to EN14511:2 Outdoor Heat exchanger inlet dry bulb temperature 35°; Indoor heat exchanger inlet water temperature 12°C, outlet water temperature 7°C. Fouling factor = 0</p> <p>(2) Voltage unbalance between phases must be within ± 3%.</p> <p>(3) Maximum running current is based on max compressor absorbed current in its envelope and max fans absorbed current.</p> <p>(4) Based on minimum allowed voltage → Max. current for wire sizing = Max. Running current x 1,1</p> <p>(5) In case of inverter driven compressor, the starting current is zero</p> <p>(6) It may change in case of unit with options or customized unit. Refer to dedicated unit's wiring diagram.</p> <p>The data are referred to the unit without additional options. All data are subject to change without notice. For updated information on project base refer to unit specific wiring diagram and unit's nameplate data.</p>								

EWAH~TZ- XL C – standard unit						
MODEL	notes		C12	C13	C14	C15
Phases		n	3			
Frequency		Hz	50			
Voltage	(2)	V	400			
Voltage Tolerances min/max		%	-10 / +10			
<b>Nominal Running Current</b>						
Nominal Running Current	(1)	A	660,3	717,4	778,2	848,9
<b>Max. running current</b>						
Max. running current	(3)	A	1038	1158	1242	1269
<b>Max. current for wire sizing</b>						
Max. current for wire sizing	(4)	A	1142	1274	1366	1396
<b>Maximum starting current</b>						
Maximum starting current	(5)	A	0	0	0	0
<b>Fan starting method</b>						
Fan starting method	(6)	-	Inverter driven motor			
<b>Max running current per fan</b>						
Max running current per fan	(6)	A	4			
<b>Total fans running current</b>						
Total fans running current	(6)	A	96	104	112	120
<b>Compressor starting method</b>						
Compressor starting method			Variable Frequency Drive			
<b>Max. running current Compressor #1</b>						
Max. running current Compressor #1	(6)	A	388	419	451	484
<b>Max. running current Compressor #2</b>						
Max. running current Compressor #2	(6)	A	388	419	451	484
<b>Main switch size</b>						
Main switch size	(6)	A	1250	1600	1600	1600
<b>Terminal connection</b>						
Terminal connection	(6)	-	Bars	Bars	Bars	Bars
<b>Cable per phase</b>						
Cable per phase	(6)	-	2x400 mm <sup>2</sup>	2x500 mm <sup>2</sup>	2x500 mm <sup>2</sup>	2x500 mm <sup>2</sup>
<b>Short circuit current I<sub>cw</sub> 1 sec.</b>						
Short circuit current I <sub>cw</sub> 1 sec.	(6)	kA	25	25	25	25
<p>(1) Standard Rating Conditions for Air to water chillers according to EN14511:2 Outdoor Heat exchanger inlet dry bulb temperature 35°; Indoor heat exchanger inlet water temperature 12°C, outlet water temperature 7°C. Fouling factor = 0</p> <p>(2) Voltage unbalance between phases must be within ± 3%.</p> <p>(3) Maximum running current is based on max compressor absorbed current in its envelope and max fans absorbed current.</p> <p>(4) Based on minimum allowed voltage → Max. current for wire sizing = Max. Running current x 1,1</p> <p>(5) In case of inverter driven compressor, the starting current is zero</p> <p>(6) It may change in case of unit with options or customized unit. Refer to dedicated unit's wiring diagram.</p> <p>The data are referred to the unit without additional options. All data are subject to change without notice. For updated information on project base refer to unit specific wiring diagram and unit's nameplate data.</p>						

EWAH~TZ- XR C – standard unit								
MODEL	notes		670	780	840	950	C10	C11
Phases		n	3					
Frequency		Hz	50					
Voltage	(2)	V	400					
Voltage Tolerances min/max		%	-10 / +10					
Nominal Running Current	(1)	A	374,9	432,6	460,2	514,2	545,4	606,0
Max. running current	(3)	A	711	698	767	914	927	1072
Max. current for wire sizing	(4)	A	782	767	844	1005	1020	1179
Maximum starting current	(5)	A	0	0	0	0	0	0
Fan starting method	(6)	-	Inverter driven motor					
Max running current per fan	(6)	A	2,6					
Total fans running current	(6)	A	36,4	41,6	46,8	57,2	62,4	67,6
Compressor starting method			Variable Frequency Drive					
Max. running current Compressor #1	(6)	A	236	248	276	291	326	367
Max. running current Compressor #2	(6)	A	236	248	276	291	326	367
Main switch size	(6)	A	800	800	1000	1000	1250	1250
Terminal connection	(6)	-	Cables	Cables	Bars	Bars	Bars	Bars
Cable per phase	(6)	-	2x240 mm <sup>2</sup>	2x240 mm <sup>2</sup>	2x300 mm <sup>2</sup>	2x300 mm <sup>2</sup>	2x400 mm <sup>2</sup>	2x400 mm <sup>2</sup>
Short circuit current Icw 1 sec.	(6)	kA	20	20	25	25	25	25
<p>(1) Standard Rating Conditions for Air to water chillers according to EN14511:2 Outdoor Heat exchanger inlet dry bulb temperature 35°; Indoor heat exchanger inlet water temperature 12°C, outlet water temperature 7°C. Fouling factor = 0</p> <p>(2) Voltage unbalance between phases must be within ± 3%.</p> <p>(3) Maximum running current is based on max compressor absorbed current in its envelope and max fans absorbed current.</p> <p>(4) Based on minimum allowed voltage → Max. current for wire sizing = Max. Running current x 1,1</p> <p>(5) In case of inverter driven compressor, the starting current is zero</p> <p>(6) It may change in case of unit with options or customized unit. Refer to dedicated unit's wiring diagram.</p> <p>The data are referred to the unit without additional options. All data are subject to change without notice. For updated information on project base refer to unit specific wiring diagram and unit's nameplate data.</p>								



EWAH~TZ- XR C – standard unit						
MODEL	notes		C12	C13	C14	C15
Phases		n	3			
Frequency		Hz	50			
Voltage	(2)	V	400			
Voltage Tolerances min/max		%	-10 / +10			
<b>Nominal Running Current</b>						
Nominal Running Current	(1)	A	670,1	725,0	783,7	853,8
<b>Max. running current</b>						
Max. running current	(3)	A	1038	1158	1242	1269
<b>Max. current for wire sizing</b>						
Max. current for wire sizing	(4)	A	1142	1274	1366	1396
<b>Maximum starting current</b>						
Maximum starting current	(5)	A	0	0	0	0
<b>Fan starting method</b>						
Fan starting method	(6)	-	Inverter driven motor			
<b>Max running current per fan</b>						
Max running current per fan	(6)	A	2,6			
<b>Total fans running current</b>						
Total fans running current	(6)	A	62,4	67,6	72,8	78,0
<b>Compressor starting method</b>						
Compressor starting method			Variable Frequency Drive			
<b>Max. running current Compressor #1</b>						
Max. running current Compressor #1	(6)	A	388	419	451	484
<b>Max. running current Compressor #2</b>						
Max. running current Compressor #2	(6)	A	388	419	451	484
<b>Main switch size</b>						
Main switch size	(6)	A	1250	1600	1600	1600
<b>Terminal connection</b>						
Terminal connection	(6)	-	Bars	Bars	Bars	Bars
<b>Cable per phase</b>						
Cable per phase	(6)	-	2x400 mm <sup>2</sup>	2x500 mm <sup>2</sup>	2x500 mm <sup>2</sup>	2x500 mm <sup>2</sup>
<b>Short circuit current I<sub>cw</sub> 1 sec.</b>						
Short circuit current I <sub>cw</sub> 1 sec.	(6)	kA	25	25	25	25
<p>(1) Standard Rating Conditions for Air to water chillers according to EN14511:2 Outdoor Heat exchanger inlet dry bulb temperature 35°; Indoor heat exchanger inlet water temperature 12°C, outlet water temperature 7°C. Fouling factor = 0</p> <p>(2) Voltage unbalance between phases must be within ± 3%.</p> <p>(3) Maximum running current is based on max compressor absorbed current in its envelope and max fans absorbed current.</p> <p>(4) Based on minimum allowed voltage → Max. current for wire sizing = Max. Running current x 1,1</p> <p>(5) In case of inverter driven compressor, the starting current is zero</p> <p>(6) It may change in case of unit with options or customized unit. Refer to dedicated unit's wiring diagram.</p> <p>The data are referred to the unit without additional options. All data are subject to change without notice. For updated information on project base refer to unit specific wiring diagram and unit's nameplate data.</p>						

EWAD~TZ- SS C – standard unit								
MODEL	notes		H11	H12	H13	C15	C16	H17
Phases		n	3					
Frequency		Hz	50					
Voltage	(2)	V	400					
Voltage Tolerances min/max		%	-10 / +10					
Nominal Running Current	(1)	A	646,5	691,1	733,0	813,9	884,0	962,8
Max. running current	(3)	A	1015	1050	1064	1294	1320	1442
Max. current for wire sizing	(4)	A	1116	1155	1170	1424	1452	1586
Maximum starting current	(5)	A	0	0	0	0	0	0
Fan starting method	(6)	-	D.O.L.					
Max running current per fan	(6)	A	4					
Total fans running current	(6)	A	88	88	96	96	104	112
Compressor starting method			Variable Frequency Drive					
Max. running current Compressor #1	(6)	A	367	388	411	480	521	562
Max. running current Compressor #2	(6)	A	367	388	411	480	521	562
Main switch size	(6)	A	1250	1250	1250	1600	1600	2000
Terminal connection	(6)	-	Bars	Bars	Bars	Bars	Bars	Bars
Cable per phase	(6)	-	2x400 mm <sup>2</sup>	2x400 mm <sup>2</sup>	2x400 mm <sup>2</sup>	2x500 mm <sup>2</sup>	2x500 mm <sup>2</sup>	3x500 mm <sup>2</sup>
Short circuit current I <sub>cw</sub> 1 sec.	(6)	kA	25	25	25	25	25	25
<p>(7) Standard Rating Conditions for Air to water chillers according to EN14511:2 Outdoor Heat exchanger inlet dry bulb temperature 35°; Indoor heat exchanger inlet water temperature 12°C, outlet water temperature 7°C. Fouling factor = 0</p> <p>(8) Voltage unbalance between phases must be within ± 3%.</p> <p>(9) Maximum running current is based on max compressor absorbed current in its envelope and max fans absorbed current.</p> <p>(10) Based on minimum allowed voltage → Max. current for wire sizing = Max. Running current x 1,1</p> <p>(11) In case of inverter driven compressor, the starting current is zero</p> <p>(12) It may change in case of unit with options or customized unit. Refer to dedicated unit's wiring diagram.</p> <p>The data are referred to the unit without additional options. All data are subject to change without notice. For updated information on project base refer to unit specific wiring diagram and unit's nameplate data.</p>								

EWAD~TZ- SS C – standard unit				
MODEL	notes		H18	H19
Phases		n	3	
Frequency		Hz	50	
Voltage	(2)	V	400	
Voltage Tolerances min/max		%	-10 / +10	
<b>Nominal Running Current</b>				
Nominal Running Current	(1)	A	1044	1149
<b>Max. running current</b>				
Max. running current	(3)	A	1551	1649
<b>Max. current for wire sizing</b>				
Max. current for wire sizing	(4)	A	1706	1814
<b>Maximum starting current</b>				
Maximum starting current	(5)	A	0	0
<b>Fan starting method</b>				
Fan starting method	(6)	-	D.O.L.	
<b>Max running current per fan</b>				
Max running current per fan	(6)	A	4	
<b>Total fans running current</b>				
Total fans running current	(6)	A	120	120
<b>Compressor starting method</b>				
Compressor starting method			Variable Frequency Drive	
<b>Max. running current Compressor #1</b>				
Max. running current Compressor #1	(6)	A	605	649
<b>Max. running current Compressor #2</b>				
Max. running current Compressor #2	(6)	A	605	649
<b>Main switch size</b>				
Main switch size	(6)	A	2000	2000
<b>Terminal connection</b>				
Terminal connection	(6)	-	Bars	Bars
<b>Cable per phase</b>				
Cable per phase	(6)	-	3x500 mm <sup>2</sup>	3x500 mm <sup>2</sup>
<b>Short circuit current I<sub>cw</sub> 1 sec.</b>				
Short circuit current I <sub>cw</sub> 1 sec.	(6)	kA	25	25
<p>(1) Standard Rating Conditions for Air to water chillers according to EN14511:2 Outdoor Heat exchanger inlet dry bulb temperature 35°; Indoor heat exchanger inlet water temperature 12°C, outlet water temperature 7°C. Fouling factor = 0</p> <p>(2) Voltage unbalance between phases must be within ± 3%.</p> <p>(3) Maximum running current is based on max compressor absorbed current in its envelope and max fans absorbed current.</p> <p>(4) Based on minimum allowed voltage → Max. current for wire sizing = Max. Running current x 1,1</p> <p>(5) In case of inverter driven compressor, the starting current is zero</p> <p>(6) It may change in case of unit with options or customized unit. Refer to dedicated unit's wiring diagram.</p>				
<p>The data are referred to the unit without additional options.  All data are subject to change without notice. For updated information on project base refer to unit specific wiring diagram and unit's nameplate data.</p>				

EWAD~TZ- SL C – standard unit								
MODEL	notes		H11	H12	H13	C15	C16	H17
Phases		n	3					
Frequency		Hz	50					
Voltage	(2)	V	400					
Voltage Tolerances min/max		%	-10 / +10					
Nominal Running Current	(1)	A	646,5	691,1	733,0	813,9	884,0	962,8
Max. running current	(3)	A	1015	1050	1064	1294	1320	1442
Max. current for wire sizing	(4)	A	1116	1155	1170	1424	1452	1586
Maximum starting current	(5)	A	0	0	0	0	0	0
Fan starting method	(6)	-	D.O.L.					
Max running current per fan	(6)	A	4					
Total fans running current	(6)	A	88	88	96	96	104	112
Compressor starting method			Variable Frequency Drive					
Max. running current Compressor #1	(6)	A	367	388	411	480	521	562
Max. running current Compressor #2	(6)	A	367	388	411	480	521	562
Main switch size	(6)	A	1250	1250	1250	1600	1600	2000
Terminal connection	(6)	-	Bars	Bars	Bars	Bars	Bars	Bars
Cable per phase	(6)	-	2x400 mm <sup>2</sup>	2x400 mm <sup>2</sup>	2x400 mm <sup>2</sup>	2x500 mm <sup>2</sup>	2x500 mm <sup>2</sup>	3x500 mm <sup>2</sup>
Short circuit current I <sub>cw</sub> 1 sec.	(6)	kA	25	25	25	25	25	25
<p>(1) Standard Rating Conditions for Air to water chillers according to EN14511:2 Outdoor Heat exchanger inlet dry bulb temperature 35°; Indoor heat exchanger inlet water temperature 12°C, outlet water temperature 7°C. Fouling factor = 0</p> <p>(2) Voltage unbalance between phases must be within ± 3%.</p> <p>(3) Maximum running current is based on max compressor absorbed current in its envelope and max fans absorbed current.</p> <p>(4) Based on minimum allowed voltage → Max. current for wire sizing = Max. Running current x 1,1</p> <p>(5) In case of inverter driven compressor, the starting current is zero</p> <p>(6) It may change in case of unit with options or customized unit. Refer to dedicated unit's wiring diagram.</p> <p>The data are referred to the unit without additional options. All data are subject to change without notice. For updated information on project base refer to unit specific wiring diagram and unit's nameplate data.</p>								

EWAD~TZ- SL C – standard unit				
MODEL	notes		H18	H19
Phases		n	3	
Frequency		Hz	50	
Voltage	(2)	V	400	
Voltage Tolerances min/max		%	-10 / +10	
<b>Nominal Running Current</b>				
Nominal Running Current	(1)	A	1044	1149
<b>Max. running current</b>				
Max. running current	(3)	A	1551	1649
<b>Max. current for wire sizing</b>				
Max. current for wire sizing	(4)	A	1706	1814
<b>Maximum starting current</b>				
Maximum starting current	(5)	A	0	0
<b>Fan starting method</b>				
Fan starting method	(6)	-	D.O.L.	
<b>Max running current per fan</b>				
Max running current per fan	(6)	A	4	
<b>Total fans running current</b>				
Total fans running current	(6)	A	120	120
<b>Compressor starting method</b>				
Compressor starting method			Variable Frequency Drive	
<b>Max. running current Compressor #1</b>				
Max. running current Compressor #1	(6)	A	605	649
<b>Max. running current Compressor #2</b>				
Max. running current Compressor #2	(6)	A	605	649
<b>Main switch size</b>				
Main switch size	(6)	A	2000	2000
<b>Terminal connection</b>				
Terminal connection	(6)	-	Bars	Bars
<b>Cable per phase</b>				
Cable per phase	(6)	-	3x500 mm <sup>2</sup>	3x500 mm <sup>2</sup>
<b>Short circuit current I<sub>cw</sub> 1 sec.</b>				
Short circuit current I <sub>cw</sub> 1 sec.	(6)	kA	25	25
<p>(1) Standard Rating Conditions for Air to water chillers according to EN14511:2 Outdoor Heat exchanger inlet dry bulb temperature 35°; Indoor heat exchanger inlet water temperature 12°C, outlet water temperature 7°C. Fouling factor = 0</p> <p>(2) Voltage unbalance between phases must be within ± 3%.</p> <p>(3) Maximum running current is based on max compressor absorbed current in its envelope and max fans absorbed current.</p> <p>(4) Based on minimum allowed voltage → Max. current for wire sizing = Max. Running current x 1,1</p> <p>(5) In case of inverter driven compressor, the starting current is zero</p> <p>(6) It may change in case of unit with options or customized unit. Refer to dedicated unit's wiring diagram.</p>				
<p>The data are referred to the unit without additional options.  All data are subject to change without notice. For updated information on project base refer to unit specific wiring diagram and unit's nameplate data.</p>				

EWAD~TZ- SR C – standard unit								
MODEL	notes		H11	H12	H13	C15	C16	H17
Phases		n	3					
Frequency		Hz	50					
Voltage	(2)	V	400					
Voltage Tolerances min/max		%	-10 / +10					
Nominal Running Current	(1)	A	659,2	708,5	748,1	853,7	922,8	1000
Max. running current	(3)	A	1015	1050	1064	1294	1320	1442
Max. current for wire sizing	(4)	A	1116	1155	1170	1424	1452	1586
Maximum starting current	(5)	A	0	0	0	0	0	0
Fan starting method	(6)	-	Inverter driven motor					
Max running current per fan	(6)	A	2,6					
Total fans running current	(6)	A	57,2	57,2	62,4	62,4	67,6	72,8
Compressor starting method			Variable Frequency Drive					
Max. running current Compressor #1	(6)	A	367	388	411	480	521	562
Max. running current Compressor #2	(6)	A	367	388	411	480	521	562
Main switch size	(6)	A	1250	1250	1250	1600	1600	2000
Terminal connection	(6)	-	Bars	Bars	Bars	Bars	Bars	Bars
Cable per phase	(6)	-	2x400 mm <sup>2</sup>	2x400 mm <sup>2</sup>	2x400 mm <sup>2</sup>	2x500 mm <sup>2</sup>	2x500 mm <sup>2</sup>	3x500 mm <sup>2</sup>
Short circuit current I <sub>cw</sub> 1 sec.	(6)	kA	25	25	25	25	25	25
<p>(1) Standard Rating Conditions for Air to water chillers according to EN14511:2 Outdoor Heat exchanger inlet dry bulb temperature 35°; Indoor heat exchanger inlet water temperature 12°C, outlet water temperature 7°C. Fouling factor = 0</p> <p>(2) Voltage unbalance between phases must be within ± 3%.</p> <p>(3) Maximum running current is based on max compressor absorbed current in its envelope and max fans absorbed current.</p> <p>(4) Based on minimum allowed voltage → Max. current for wire sizing = Max. Running current x 1,1</p> <p>(5) In case of inverter driven compressor, the starting current is zero</p> <p>(6) It may change in case of unit with options or customized unit. Refer to dedicated unit's wiring diagram.</p> <p>The data are referred to the unit without additional options. All data are subject to change without notice. For updated information on project base refer to unit specific wiring diagram and unit's nameplate data.</p>								

EWAD~TZ- SR C – standard unit				
MODEL	notes		H18	H19
Phases		n	3	
Frequency		Hz	50	
Voltage	(2)	V	400	
Voltage Tolerances min/max		%	-10 / +10	
<b>Nominal Running Current</b>				
Nominal Running Current	(1)	A	1080	1194
<b>Max. running current</b>				
Max. running current	(3)	A	1551	1649
<b>Max. current for wire sizing</b>				
Max. current for wire sizing	(4)	A	1706	1814
<b>Maximum starting current</b>				
Maximum starting current	(5)	A	0	0
<b>Fan starting method</b>				
Fan starting method	(6)	-	Inverter driven motor	
<b>Max running current per fan</b>				
Max running current per fan	(6)	A	2,6	
<b>Total fans running current</b>				
Total fans running current	(6)	A	78,0	78,0
<b>Compressor starting method</b>				
Compressor starting method			Variable Frequency Drive	
<b>Max. running current Compressor #1</b>				
Max. running current Compressor #1	(6)	A	605	649
<b>Max. running current Compressor #2</b>				
Max. running current Compressor #2	(6)	A	605	649
<b>Main switch size</b>				
Main switch size	(6)	A	2000	2000
<b>Terminal connection</b>				
Terminal connection	(6)	-	Bars	Bars
<b>Cable per phase</b>				
Cable per phase	(6)	-	3x500 mm <sup>2</sup>	3x500 mm <sup>2</sup>
<b>Short circuit current I<sub>cw</sub> 1 sec.</b>				
Short circuit current I <sub>cw</sub> 1 sec.	(6)	kA	25	25
<p>(1) Standard Rating Conditions for Air to water chillers according to EN14511:2 Outdoor Heat exchanger inlet dry bulb temperature 35°; Indoor heat exchanger inlet water temperature 12°C, outlet water temperature 7°C. Fouling factor = 0</p> <p>(2) Voltage unbalance between phases must be within ± 3%.</p> <p>(3) Maximum running current is based on max compressor absorbed current in its envelope and max fans absorbed current.</p> <p>(4) Based on minimum allowed voltage → Max. current for wire sizing = Max. Running current x 1,1</p> <p>(5) In case of inverter driven compressor, the starting current is zero</p> <p>(6) It may change in case of unit with options or customized unit. Refer to dedicated unit's wiring diagram.</p>				
<p>The data are referred to the unit without additional options.  All data are subject to change without notice. For updated information on project base refer to unit specific wiring diagram and unit's nameplate data.</p>				



EWAD~TZ- XS C – standard unit								
MODEL	notes		C11	C12	H12	C14	C15	H16
Phases		n	3					
Frequency		Hz	50					
Voltage	(2)	V	400					
Voltage Tolerances min/max		%	-10/ +10					
Nominal Running Current	(1)	A	608,8	647,1	686,1	735,8	806,6	874,7
Max. running current	(3)	A	1021	1028	1062	1205	1246	1333
Max. current for wire sizing	(4)	A	1123	1131	1168	1326	1371	1467
Maximum starting current	(5)	A	0	0	0	0	0	0
Fan starting method	(6)	-	Inverter driven motor					
Max running current per fan	(6)	A	2,6	2,6	2,6	4	4	4
Total fans running current	(6)	A	57,2	62,4	67,6	62,4	67,6	72,8
Compressor starting method			Variable Frequency Drive					
Max. running current Compressor #1	(6)	A	370	367	388	440	480	521
Max. running current Compressor #2	(6)	A	370	367	388	440	480	521
Main switch size	(6)	A	1250	1250	1250	1600	1600	1600
Terminal connection	(6)	-	Bars	Bars	Bars	Bars	Bars	Bars
Cable per phase	(6)	-	2x400 mm <sup>2</sup>	2x400 mm <sup>2</sup>	2x400 mm <sup>2</sup>	2x500 mm <sup>2</sup>	2x500 mm <sup>2</sup>	2x500 mm <sup>2</sup>
Short circuit current I <sub>cs</sub> 1 sec.	(6)	kA	25	25	25	25	25	25
<p>(1) Standard Rating Conditions for Air to water chillers according to EN14511:2 Outdoor Heat exchanger inlet dry bulb temperature 35°; Indoor heat exchanger inlet water temperature 12°C, outlet water temperature 7°C. Fouling factor = 0</p> <p>(2) Voltage unbalance between phases must be within ± 3%.</p> <p>(3) Maximum running current is based on max compressor absorbed current in its envelope and max fans absorbed current.</p> <p>(4) Based on minimum allowed voltage → Max. current for wire sizing = Max. Running current x 1,1</p> <p>(5) In case of inverter driven compressor, the starting current is zero</p> <p>(6) It may change in case of unit with options or customized unit. Refer to dedicated unit's wiring diagram.</p> <p>The data are referred to the unit without additional options. All data are subject to change without notice. For updated information on project base refer to unit specific wiring diagram and unit's nameplate data.</p>								

EWAD~TZ- XS C – standard unit			
MODEL	notes		H17
Phases		n	3
Frequency		Hz	50
Voltage	(2)	V	400
Voltage Tolerances min/max		%	-10 / +10
<b>Nominal Running Current</b>			
Nominal Running Current	(1)	A	957,5
<b>Max. running current</b>			
Max. running current	(3)	A	1456
<b>Max. current for wire sizing</b>			
Max. current for wire sizing	(4)	A	1601
<b>Maximum starting current</b>			
Maximum starting current	(5)	A	0
<b>Fan starting method</b>			
Fan starting method	(6)	-	Inverter driven motor
<b>Max running current per fan</b>			
Max running current per fan	(6)	A	4
<b>Total fans running current</b>			
Total fans running current	(6)	A	120
<b>Compressor starting method</b>			
Compressor starting method			Variable Frequency Drive
<b>Max. running current Compressor #1</b>			
Max. running current Compressor #1	(6)	A	562
<b>Max. running current Compressor #2</b>			
Max. running current Compressor #2	(6)	A	562
<b>Main switch size</b>			
Main switch size	(6)	A	2000
<b>Terminal connection</b>			
Terminal connection	(6)	-	Bars
<b>Cable per phase</b>			
Cable per phase	(6)	-	3x500 mm <sup>2</sup>
<b>Short circuit current I<sub>cw</sub> 1 sec.</b>			
Short circuit current I <sub>cw</sub> 1 sec.	(6)	kA	25
<p>(1) Standard Rating Conditions for Air to water chillers according to EN14511:2 Outdoor Heat exchanger inlet dry bulb temperature 35°; Indoor heat exchanger inlet water temperature 12°C, outlet water temperature 7°C. Fouling factor = 0</p> <p>(2) Voltage unbalance between phases must be within ± 3%.</p> <p>(3) Maximum running current is based on max compressor absorbed current in its envelope and max fans absorbed current.</p> <p>(4) Based on minimum allowed voltage → Max. current for wire sizing = Max. Running current x 1,1</p> <p>(5) In case of inverter driven compressor, the starting current is zero</p> <p>(6) It may change in case of unit with options or customized unit. Refer to dedicated unit's wiring diagram.</p>			
<p>The data are referred to the unit without additional options.  All data are subject to change without notice. For updated information on project base refer to unit specific wiring diagram and unit's nameplate data.</p>			

EWAD~TZ- XR C – standard unit								
MODEL	notes		C11	C12	H12	C14	C15	H16
Phases		n	3					
Frequency		Hz	50					
Voltage	(2)	V	400					
Voltage Tolerances min/max		%	-10/ +10					
Nominal Running Current	(1)	A	612,3	651,0	689,6	762,5	834,0	901,3
Max. running current	(3)	A	1021	1028	1062	1205	1246	1333
Max. current for wire sizing	(4)	A	1123	1131	1168	1326	1371	1467
Maximum starting current	(5)	A	0	0	0	0	0	0
Fan starting method	(6)	-	Inverter driven motor					
Max running current per fan	(6)	A	2,6					
Total fans running current	(6)	A	57,2	62,4	67,6	62,4	67,6	72,8
Compressor starting method			Variable Frequency Drive					
Max. running current Compressor #1	(6)	A	370	367	388	440	480	521
Max. running current Compressor #2	(6)	A	370	367	388	440	480	521
Main switch size	(6)	A	1250	1250	1250	1600	1600	1600
Terminal connection	(6)	-	Bars	Bars	Bars	Bars	Bars	Bars
Cable per phase	(6)	-	2x400 mm <sup>2</sup>	2x400 mm <sup>2</sup>	2x400 mm <sup>2</sup>	2x500 mm <sup>2</sup>	2x500 mm <sup>2</sup>	2x500 mm <sup>2</sup>
Short circuit current I <sub>cw</sub> 1 sec.	(6)	kA	25	25	25	25	25	25
<p>(1) Standard Rating Conditions for Air to water chillers according to EN14511:2 Outdoor Heat exchanger inlet dry bulb temperature 35°; Indoor heat exchanger inlet water temperature 12°C, outlet water temperature 7°C. Fouling factor = 0</p> <p>(2) Voltage unbalance between phases must be within ± 3%.</p> <p>(3) Maximum running current is based on max compressor absorbed current in its envelope and max fans absorbed current.</p> <p>(4) Based on minimum allowed voltage → Max. current for wire sizing = Max. Running current x 1,1</p> <p>(5) In case of inverter driven compressor, the starting current is zero</p> <p>(6) It may change in case of unit with options or customized unit. Refer to dedicated unit's wiring diagram.</p> <p>The data are referred to the unit without additional options. All data are subject to change without notice. For updated information on project base refer to unit specific wiring diagram and unit's nameplate data.</p>								

EWAD~TZ- XR C – standard unit			
MODEL	notes		H17
Phases		n	3
Frequency		Hz	50
Voltage	(2)	V	400
Voltage Tolerances min/max		%	-10 / +10
<b>Nominal Running Current</b>			
Nominal Running Current	(1)	A	982,6
<b>Max. running current</b>			
Max. running current	(3)	A	1456
<b>Max. current for wire sizing</b>			
Max. current for wire sizing	(4)	A	1601
<b>Maximum starting current</b>			
Maximum starting current	(5)	A	0
<b>Fan starting method</b>			
Fan starting method	(6)	-	Inverter driven motor
<b>Max running current per fan</b>			
Max running current per fan	(6)	A	2,6
<b>Total fans running current</b>			
Total fans running current	(6)	A	78,0
<b>Compressor starting method</b>			
Compressor starting method			Variable Frequency Drive
<b>Max. running current Compressor #1</b>			
Max. running current Compressor #1	(6)	A	562
<b>Max. running current Compressor #2</b>			
Max. running current Compressor #2	(6)	A	562
<b>Main switch size</b>			
Main switch size	(6)	A	2000
<b>Terminal connection</b>			
Terminal connection	(6)	-	Bars
<b>Cable per phase</b>			
Cable per phase	(6)	-	3x500 mm <sup>2</sup>
<b>Short circuit current I<sub>cw</sub> 1 sec.</b>			
Short circuit current I <sub>cw</sub> 1 sec.	(6)	kA	25
<p>(1) Standard Rating Conditions for Air to water chillers according to EN14511:2 Outdoor Heat exchanger inlet dry bulb temperature 35°; Indoor heat exchanger inlet water temperature 12°C, outlet water temperature 7°C. Fouling factor = 0</p> <p>(2) Voltage unbalance between phases must be within ± 3%.</p> <p>(3) Maximum running current is based on max compressor absorbed current in its envelope and max fans absorbed current.</p> <p>(4) Based on minimum allowed voltage → Max. current for wire sizing = Max. Running current x 1,1</p> <p>(5) In case of inverter driven compressor, the starting current is zero</p> <p>(6) It may change in case of unit with options or customized unit. Refer to dedicated unit's wiring diagram.</p>			
<p>The data are referred to the unit without additional options.  All data are subject to change without notice. For updated information on project base refer to unit specific wiring diagram and unit's nameplate data.</p>			

EWAH~TZ- SS C + OPT158 – BRUSHLESS FANS UP 900 RPM								
MODEL	notes		710	770	880	940	990	H10
Phases		n	3					
Frequency		Hz	50					
Voltage	(2)	V	400					
Voltage Tolerances min/max		%	-10 / +10					
Nominal Running Current	(1)	A	383,7	408,6	465,1	489,5	514,2	540,2
Max. running current	(3)	A	674	711	880	893	907	949
Max. current for wire sizing	(4)	A	742	782	967	982	997	1044
Maximum starting current	(5)	A	0	0	0	0	0	0
Fan starting method	(6)	-	EC Brushless Motor					
Max running current per fan	(6)	A	2,22					
Total fans running current	(6)	A	31,1	31,1	35,5	40,0	44,4	48,8
Compressor starting method			Variable Frequency Drive					
Max. running current Compressor #1	(6)	A	246	262	291	308	326	345
Max. running current Compressor #2	(6)	A	246	262	291	308	326	345
Main switch size	(6)	A	800	800	1000	1000	1250	1250
Terminal connection	(6)	-	Cables	Cables	Bars	Bars	Bars	Bars
Cable per phase	(6)	-	2x240 mm <sup>2</sup>	2x240 mm <sup>2</sup>	2x300 mm <sup>2</sup>	2x300 mm <sup>2</sup>	2x400 mm <sup>2</sup>	2x400 mm <sup>2</sup>
Short circuit current I <sub>cw</sub> 1 sec.	(6)	kA	20	20	25	25	25	25
<p>(1) Standard Rating Conditions for Air to water chillers according to EN14511:2 Outdoor Heat exchanger inlet dry bulb temperature 35°; Indoor heat exchanger inlet water temperature 12°C, outlet water temperature 7°C. Fouling factor = 0</p> <p>(2) Voltage unbalance between phases must be within ± 3%.</p> <p>(3) Maximum running current is based on max compressor absorbed current in its envelope and max fans absorbed current.</p> <p>(4) Based on minimum allowed voltage → Max. current for wire sizing = Max. Running current x 1,1</p> <p>(5) In case of inverter driven compressor, the starting current is zero</p> <p>(6) It may change in case of unit with options or customized unit. Refer to dedicated unit's wiring diagram.</p> <p>The data are referred to the unit without additional options. All data are subject to change without notice. For updated information on project base refer to unit specific wiring diagram and unit's nameplate data.</p>								

EWAH~TZ- SS C + OPT158 – BRUSHLESS FANS UP 900 RPM								
MODEL	notes		C11	C12	C13	C14	C15	C16
Phases		n	3					
Frequency		Hz	50					
Voltage	(2)	V	400					
Voltage Tolerances min/max		%	-10 / +10					
<b>Nominal Running Current</b>								
Nominal Running Current	(1)	A	569,5	622,1	676,2	734,7	799,1	881,5
<b>Max. running current</b>								
Max. running current	(3)	A	1058	1072	1144	1228	1315	1333
<b>Max. current for wire sizing</b>								
Max. current for wire sizing	(4)	A	1164	1179	1258	1351	1447	1466
<b>Maximum starting current</b>								
Maximum starting current	(5)	A	0	0	0	0	0	0
<b>Fan starting method</b>								
Fan starting method	(6)	-	EC Brushless Motor					
<b>Max running current per fan</b>								
Max running current per fan	(6)	A	2,22					
<b>Total fans running current</b>								
Total fans running current	(6)	A	53,3	57,7	53,3	57,7	62,2	66,6
<b>Compressor starting method</b>								
Compressor starting method			Variable Frequency Drive					
<b>Max. running current Compressor #1</b>								
Max. running current Compressor #1	(6)	A	367	415	419	451	484	518
<b>Max. running current Compressor #2</b>								
Max. running current Compressor #2	(6)	A	367	415	419	451	484	518
<b>Main switch size</b>								
Main switch size	(6)	A	1250	1250	1600	1600	1600	1600
<b>Terminal connection</b>								
Terminal connection	(6)	-	Bars	Bars	Bars	Bars	Bars	Bars
<b>Cable per phase</b>								
Cable per phase	(6)	-	2x400 mm <sup>2</sup>	2x400 mm <sup>2</sup>	2x500 mm <sup>2</sup>	2x500 mm <sup>2</sup>	2x500 mm <sup>2</sup>	2x500 mm <sup>2</sup>
<b>Short circuit current Icw 1 sec.</b>								
Short circuit current Icw 1 sec.	(6)	kA	25	25	25	25	25	25
<p>(1) Standard Rating Conditions for Air to water chillers according to EN14511:2 Outdoor Heat exchanger inlet dry bulb temperature 35°; Indoor heat exchanger inlet water temperature 12°C, outlet water temperature 7°C. Fouling factor = 0</p> <p>(2) Voltage unbalance between phases must be within ± 3%.</p> <p>(3) Maximum running current is based on max compressor absorbed current in its envelope and max fans absorbed current.</p> <p>(4) Based on minimum allowed voltage → Max. current for wire sizing = Max. Running current x 1,1</p> <p>(5) In case of inverter driven compressor, the starting current is zero</p> <p>(6) It may change in case of unit with options or customized unit. Refer to dedicated unit's wiring diagram.</p>								
<p>The data are referred to the unit without additional options.</p> <p>All data are subject to change without notice. For updated information on project base refer to unit specific wiring diagram and unit's nameplate data.</p>								

EWAH~TZ- SL C + OPT158 – BRUSHLESS FANS UP 900 RPM								
MODEL	notes		710	770	880	940	990	H10
Phases		n	3					
Frequency		Hz	50					
Voltage	(2)	V	400					
Voltage Tolerances min/max		%	-10 / +10					
Nominal Running Current	(1)	A	383,7	408,6	465,1	489,5	514,2	540,2
Max. running current	(3)	A	674	711	879	893	907	949
Max. current for wire sizing	(4)	A	741	782	967	982	998	1044
Maximum starting current	(5)	A	0	0	0	0	0	0
Fan starting method	(6)	-	EC Brushless Motor					
Max running current per fan	(6)	A	2,22					
Total fans running current	(6)	A	31,1	31,1	35,5	40,0	44,4	48,8
Compressor starting method			Variable Frequency Drive					
Max. running current Compressor #1	(6)	A	246	262	291	308	326	345
Max. running current Compressor #2	(6)	A	246	262	291	308	326	345
Main switch size	(6)	A	800	800	1000	1000	1250	1250
Terminal connection	(6)	-	Cables	Cables	Bars	Bars	Bars	Bars
Cable per phase	(6)	-	2x240 mm <sup>2</sup>	2x240 mm <sup>2</sup>	2x300 mm <sup>2</sup>	2x300 mm <sup>2</sup>	2x400 mm <sup>2</sup>	2x400 mm <sup>2</sup>
Short circuit current Icw 1 sec.	(6)	kA	20	20	25	25	25	25
<p>(1) Standard Rating Conditions for Air to water chillers according to EN14511:2 Outdoor Heat exchanger inlet dry bulb temperature 35°; Indoor heat exchanger inlet water temperature 12°C, outlet water temperature 7°C. Fouling factor = 0</p> <p>(2) Voltage unbalance between phases must be within ± 3%.</p> <p>(3) Maximum running current is based on max compressor absorbed current in its envelope and max fans absorbed current.</p> <p>(4) Based on minimum allowed voltage → Max. current for wire sizing = Max. Running current x 1,1</p> <p>(5) In case of inverter driven compressor, the starting current is zero</p> <p>(6) It may change in case of unit with options or customized unit. Refer to dedicated unit's wiring diagram.</p> <p>The data are referred to the unit without additional options. All data are subject to change without notice. For updated information on project base refer to unit specific wiring diagram and unit's nameplate data.</p>								



EWAH~TZ- SL C + OPT158 – BRUSHLESS FANS UP 900 RPM								
MODEL	notes		C11	C12	C13	C14	C15	C16
Phases		n	3					
Frequency		Hz	50					
Voltage	(2)	V	400					
Voltage Tolerances min/max		%	-10 / +10					
<b>Nominal Running Current</b>								
Nominal Running Current	(1)	A	569,5	622,1	676,2	734,7	799,1	881,5
<b>Max. running current</b>								
Max. running current	(3)	A	1058	1072	1144	1228	1315	1333
<b>Max. current for wire sizing</b>								
Max. current for wire sizing	(4)	A	1164	1179	1258	1351	1447	1466
<b>Maximum starting current</b>								
Maximum starting current	(5)	A	0	0	0	0	0	0
<b>Fan starting method</b>								
Fan starting method	(6)	-	EC Brushless Motor					
<b>Max running current per fan</b>								
Max running current per fan	(6)	A	2,22					
<b>Total fans running current</b>								
Total fans running current	(6)	A	53,3	57,7	53,3	57,7	62,2	66,6
<b>Compressor starting method</b>								
Compressor starting method			Variable Frequency Drive					
<b>Max. running current Compressor #1</b>								
Max. running current Compressor #1	(6)	A	367	415	419	451	484	518
<b>Max. running current Compressor #2</b>								
Max. running current Compressor #2	(6)	A	367	415	419	451	484	518
<b>Main switch size</b>								
Main switch size	(6)	A	1250	1250	1600	1600	1600	1600
<b>Terminal connection</b>								
Terminal connection	(6)	-	Bars	Bars	Bars	Bars	Bars	Bars
<b>Cable per phase</b>								
Cable per phase	(6)	-	2x400 mm <sup>2</sup>	2x400 mm <sup>2</sup>	2x500 mm <sup>2</sup>	2x500 mm <sup>2</sup>	2x500 mm <sup>2</sup>	2x500 mm <sup>2</sup>
<b>Short circuit current Icw 1 sec.</b>								
Short circuit current Icw 1 sec.	(6)	kA	25	25	25	25	25	25
<p>(1) Standard Rating Conditions for Air to water chillers according to EN14511:2 Outdoor Heat exchanger inlet dry bulb temperature 35°; Indoor heat exchanger inlet water temperature 12°C, outlet water temperature 7°C. Fouling factor = 0</p> <p>(2) Voltage unbalance between phases must be within ± 3%.</p> <p>(3) Maximum running current is based on max compressor absorbed current in its envelope and max fans absorbed current.</p> <p>(4) Based on minimum allowed voltage → Max. current for wire sizing = Max. Running current x 1,1</p> <p>(5) In case of inverter driven compressor, the starting current is zero</p> <p>(6) It may change in case of unit with options or customized unit. Refer to dedicated unit's wiring diagram.</p> <p>The data are referred to the unit without additional options. All data are subject to change without notice. For updated information on project base refer to unit specific wiring diagram and unit's nameplate data.</p>								

EWAH~TZ- SR C + OPT159 – BRUSHLESS FANS UP 700 RPM								
MODEL	notes		710	770	880	940	990	H10
Phases		n	3					
Frequency		Hz	50					
Voltage	(2)	V	400					
Voltage Tolerances min/max		%	-10 / +10					
Nominal Running Current	(1)	A	391,3	423,1	478,2	499,3	520,8	544,1
Max. running current	(3)	A	674	711	880	893	907	949
Max. current for wire sizing	(4)	A	742	782	967	982	997	1044
Maximum starting current	(5)	A	0	0	0	0	0	0
Fan starting method	(6)	-	EC Brushless Motor					
Max running current per fan	(6)	A	1,40					
Total fans running current	(6)	A	19,6	19,6	22,4	25,2	28,0	30,8
Compressor starting method			Variable Frequency Drive					
Max. running current Compressor #1	(6)	A	246	262	291	308	326	345
Max. running current Compressor #2	(6)	A	246	262	291	308	326	345
Main switch size	(6)	A	800	800	1000	1000	1250	1250
Terminal connection	(6)	-	Cables	Cables	Bars	Bars	Bars	Bars
Cable per phase	(6)	-	2x240 mm <sup>2</sup>	2x240 mm <sup>2</sup>	2x300 mm <sup>2</sup>	2x300 mm <sup>2</sup>	2x400 mm <sup>2</sup>	2x400 mm <sup>2</sup>
Short circuit current Icw 1 sec.	(6)	kA	20	20	25	25	25	25
<p>(1) Standard Rating Conditions for Air to water chillers according to EN14511:2 Outdoor Heat exchanger inlet dry bulb temperature 35°; Indoor heat exchanger inlet water temperature 12°C, outlet water temperature 7°C. Fouling factor = 0</p> <p>(2) Voltage unbalance between phases must be within ± 3%.</p> <p>(3) Maximum running current is based on max compressor absorbed current in its envelope and max fans absorbed current.</p> <p>(4) Based on minimum allowed voltage → Max. current for wire sizing = Max. Running current x 1,1</p> <p>(5) In case of inverter driven compressor, the starting current is zero</p> <p>(6) It may change in case of unit with options or customized unit. Refer to dedicated unit's wiring diagram.</p> <p>The data are referred to the unit without additional options. All data are subject to change without notice. For updated information on project base refer to unit specific wiring diagram and unit's nameplate data.</p>								

EWAH~TZ- SR C + OPT159 – BRUSHLESS FANS UP 700 RPM								
MODEL	notes		C11	C12	C13	C14	C15	C16
Phases		n	3					
Frequency		Hz	50					
Voltage	(2)	V	400					
Voltage Tolerances min/max		%	-10 / +10					
<b>Nominal Running Current</b>								
Nominal Running Current	(1)	A	570,9	623,7	695,9	752,6	816,7	901,3
<b>Max. running current</b>								
Max. running current	(3)	A	1058	1072	1144	1228	1315	1333
<b>Max. current for wire sizing</b>								
Max. current for wire sizing	(4)	A	1164	1179	1258	1351	1447	1466
<b>Maximum starting current</b>								
Maximum starting current	(5)	A	0	0	0	0	0	0
<b>Fan starting method</b>								
Fan starting method	(6)	-	EC Brushless Motor					
<b>Max running current per fan</b>								
Max running current per fan	(6)	A	1,40					
<b>Total fans running current</b>								
Total fans running current	(6)	A	33,6	36,4	33,6	36,4	39,2	42,0
<b>Compressor starting method</b>								
Compressor starting method			Variable Frequency Drive					
<b>Max. running current Compressor #1</b>								
Max. running current Compressor #1	(6)	A	367	415	419	451	484	518
<b>Max. running current Compressor #2</b>								
Max. running current Compressor #2	(6)	A	367	415	419	451	484	518
<b>Main switch size</b>								
Main switch size	(6)	A	1250	1250	1600	1600	1600	1600
<b>Terminal connection</b>								
Terminal connection	(6)	-	Bars	Bars	Bars	Bars	Bars	Bars
<b>Cable per phase</b>								
Cable per phase	(6)	-	2x400 mm <sup>2</sup>	2x400 mm <sup>2</sup>	2x500 mm <sup>2</sup>	2x500 mm <sup>2</sup>	2x500 mm <sup>2</sup>	2x500 mm <sup>2</sup>
<b>Short circuit current I<sub>cs</sub> 1 sec.</b>								
Short circuit current I <sub>cs</sub> 1 sec.	(6)	kA	25	25	25	25	25	25
<p>(1) Standard Rating Conditions for Air to water chillers according to EN14511:2 Outdoor Heat exchanger inlet dry bulb temperature 35°; Indoor heat exchanger inlet water temperature 12°C, outlet water temperature 7°C. Fouling factor = 0</p> <p>(2) Voltage unbalance between phases must be within ± 3%.</p> <p>(3) Maximum running current is based on max compressor absorbed current in its envelope and max fans absorbed current.</p> <p>(4) Based on minimum allowed voltage → Max. current for wire sizing = Max. Running current x 1,1</p> <p>(5) In case of inverter driven compressor, the starting current is zero</p> <p>(6) It may change in case of unit with options or customized unit. Refer to dedicated unit's wiring diagram.</p> <p>The data are referred to the unit without additional options. All data are subject to change without notice. For updated information on project base refer to unit specific wiring diagram and unit's nameplate data.</p>								

EWAH~TZ- XS C + OPT159 – BRUSHLESS FANS UP 700 RPM								
MODEL	notes		670	780	840	950	C10	C11
Phases		n	3					
Frequency		Hz	50					
Voltage	(2)	V	400					
Voltage Tolerances min/max		%	-10 / +10					
Nominal Running Current	(1)	A	350,3	404,3	428,9	476,3	504,1	561,4
Max. running current	(3)	A	711	698	767	914	927	1072
Max. current for wire sizing	(4)	A	782	767	844	1005	1020	1179
Maximum starting current	(5)	A	0	0	0	0	0	0
Fan starting method	(6)	-	EC Brushless Motor					
Max running current per fan	(6)	A	1,40					
Total fans running current	(6)	A	19,6	22,4	25,2	30,8	33,6	36,4
Compressor starting method			Variable Frequency Drive					
Max. running current Compressor #1	(6)	A	236	248	276	291	326	367
Max. running current Compressor #2	(6)	A	236	248	276	291	326	367
Main switch size	(6)	A	800	800	1000	1000	1250	1250
Terminal connection	(6)	-	Cables	Cables	Bars	Bars	Bars	Bars
Cable per phase	(6)	-	2x240 mm <sup>2</sup>	2x240 mm <sup>2</sup>	2x300 mm <sup>2</sup>	2x300 mm <sup>2</sup>	2x400 mm <sup>2</sup>	2x400 mm <sup>2</sup>
Short circuit current l <sub>cw</sub> 1 sec.	(6)	kA	20	20	25	25	25	25
<p>(1) Standard Rating Conditions for Air to water chillers according to EN14511:2 Outdoor Heat exchanger inlet dry bulb temperature 35°; Indoor heat exchanger inlet water temperature 12°C, outlet water temperature 7°C. Fouling factor = 0</p> <p>(2) Voltage unbalance between phases must be within ± 3%.</p> <p>(3) Maximum running current is based on max compressor absorbed current in its envelope and max fans absorbed current.</p> <p>(4) Based on minimum allowed voltage → Max. current for wire sizing = Max. Running current x 1,1</p> <p>(5) In case of inverter driven compressor, the starting current is zero</p> <p>(6) It may change in case of unit with options or customized unit. Refer to dedicated unit's wiring diagram.</p> <p>The data are referred to the unit without additional options. All data are subject to change without notice. For updated information on project base refer to unit specific wiring diagram and unit's nameplate data.</p>								

EWAH~TZ- XS C + OPT158 – BRUSHLESS FANS UP 900 RPM						
MODEL	notes		C12	C13	C14	C15
Phases		n	3			
Frequency		Hz	50			
Voltage	(2)	V	400			
Voltage Tolerances min/max		%	-10 / +10			
<b>Nominal Running Current</b>						
Nominal Running Current	(1)	A	614,8	668,0	724,9	791,7
<b>Max. running current</b>						
Max. running current	(3)	A	1038	1158	1242	1269
<b>Max. current for wire sizing</b>						
Max. current for wire sizing	(4)	A	1142	1274	1366	1396
<b>Maximum starting current</b>						
Maximum starting current	(5)	A	0	0	0	0
<b>Fan starting method</b>						
Fan starting method	(6)	-	EC Brushless Motor			
<b>Max running current per fan</b>						
Max running current per fan	(6)	A	2,22			
<b>Total fans running current</b>						
Total fans running current	(6)	A	53,3	57,7	62,2	66,6
<b>Compressor starting method</b>						
Compressor starting method			Variable Frequency Drive			
<b>Max. running current Compressor #1</b>						
Max. running current Compressor #1	(6)	A	388	419	451	484
<b>Max. running current Compressor #2</b>						
Max. running current Compressor #2	(6)	A	388	419	451	484
<b>Main switch size</b>						
Main switch size	(6)	A	1250	1600	1600	1600
<b>Terminal connection</b>						
Terminal connection	(6)	-	Bars	Bars	Bars	Bars
<b>Cable per phase</b>						
Cable per phase	(6)	-	2x400 mm <sup>2</sup>	2x500 mm <sup>2</sup>	2x500 mm <sup>2</sup>	2x500 mm <sup>2</sup>
<b>Short circuit current I<sub>cw</sub> 1 sec.</b>						
Short circuit current I <sub>cw</sub> 1 sec.	(6)	kA	25	25	25	25
<p>(1) Standard Rating Conditions for Air to water chillers according to EN14511:2 Outdoor Heat exchanger inlet dry bulb temperature 35°; Indoor heat exchanger inlet water temperature 12°C, outlet water temperature 7°C. Fouling factor = 0</p> <p>(2) Voltage unbalance between phases must be within ± 3%.</p> <p>(3) Maximum running current is based on max compressor absorbed current in its envelope and max fans absorbed current.</p> <p>(4) Based on minimum allowed voltage → Max. current for wire sizing = Max. Running current x 1,1</p> <p>(5) In case of inverter driven compressor, the starting current is zero</p> <p>(6) It may change in case of unit with options or customized unit. Refer to dedicated unit's wiring diagram.</p> <p>The data are referred to the unit without additional options. All data are subject to change without notice. For updated information on project base refer to unit specific wiring diagram and unit's nameplate data.</p>						

EWAH~TZ- XL C + OPT159 – BRUSHLESS FANS UP 700 RPM								
MODEL	notes		670	780	840	950	C10	C11
Phases		n	3					
Frequency		Hz	50					
Voltage	(2)	V	400					
Voltage Tolerances min/max		%	-10 / +10					
Nominal Running Current	(1)	A	350,3	404,3	428,9	476,3	504,1	561,4
Max. running current	(3)	A	711	698	767	914	927	1072
Max. current for wire sizing	(4)	A	782	768	844	1005	1020	1179
Maximum starting current	(5)	A	0	0	0	0	0	0
Fan starting method	(6)	-	EC Brushless Motor					
Max running current per fan	(6)	A	1,40					
Total fans running current	(6)	A	19,6	22,4	25,2	30,8	33,6	36,4
Compressor starting method			Variable Frequency Drive					
Max. running current Compressor #1	(6)	A	236	248	276	291	326	367
Max. running current Compressor #2	(6)	A	236	248	276	291	326	367
Main switch size	(6)	A	800	800	1000	1000	1250	1250
Terminal connection	(6)	-	Cables	Cables	Bars	Bars	Bars	Bars
Cable per phase	(6)	-	2x240 mm <sup>2</sup>	2x240 mm <sup>2</sup>	2x300 mm <sup>2</sup>	2x300 mm <sup>2</sup>	2x400 mm <sup>2</sup>	2x400 mm <sup>2</sup>
Short circuit current Icw 1 sec.	(6)	kA	20	20	25	25	25	25
<p>(1) Standard Rating Conditions for Air to water chillers according to EN14511:2 Outdoor Heat exchanger inlet dry bulb temperature 35°; Indoor heat exchanger inlet water temperature 12°C, outlet water temperature 7°C. Fouling factor = 0</p> <p>(2) Voltage unbalance between phases must be within ± 3%.</p> <p>(3) Maximum running current is based on max compressor absorbed current in its envelope and max fans absorbed current.</p> <p>(4) Based on minimum allowed voltage → Max. current for wire sizing = Max. Running current x 1,1</p> <p>(5) In case of inverter driven compressor, the starting current is zero</p> <p>(6) It may change in case of unit with options or customized unit. Refer to dedicated unit's wiring diagram.</p> <p>The data are referred to the unit without additional options. All data are subject to change without notice. For updated information on project base refer to unit specific wiring diagram and unit's nameplate data.</p>								

EWAH~TZ- XL C + OPT158 – BRUSHLESS FANS UP 900 RPM						
MODEL	notes		C12	C13	C14	C15
Phases		n	3			
Frequency		Hz	50			
Voltage	(2)	V	400			
Voltage Tolerances min/max		%	-10 / +10			
Nominal Running Current	(1)	A	614,8	668,0	724,9	791,7
Max. running current	(3)	A	1038	1158	1242	1269
Max. current for wire sizing	(4)	A	1142	1274	1366	1396
Maximum starting current	(5)	A	0	0	0	0
Fan starting method	(6)	-	EC Brushless Motor			
Max running current per fan	(6)	A	2,22			
Total fans running current	(6)	A	53,3	57,7	62,2	66,6
Compressor starting method			Variable Frequency Drive			
Max. running current Compressor #1	(6)	A	388	419	451	484
Max. running current Compressor #2	(6)	A	388	419	451	484
Main switch size	(6)	A	1250	1600	1600	1600
Terminal connection	(6)	-	Bars	Bars	Bars	Bars
Cable per phase	(6)	-	2x400 mm <sup>2</sup>	2x500 mm <sup>2</sup>	2x500 mm <sup>2</sup>	2x500 mm <sup>2</sup>
Short circuit current I <sub>cw</sub> 1 sec.	(6)	kA	25	25	25	25
<p>(1) Standard Rating Conditions for Air to water chillers according to EN14511:2 Outdoor Heat exchanger inlet dry bulb temperature 35°; Indoor heat exchanger inlet water temperature 12°C, outlet water temperature 7°C. Fouling factor = 0</p> <p>(2) Voltage unbalance between phases must be within ± 3%.</p> <p>(3) Maximum running current is based on max compressor absorbed current in its envelope and max fans absorbed current.</p> <p>(4) Based on minimum allowed voltage → Max. current for wire sizing = Max. Running current x 1,1</p> <p>(5) In case of inverter driven compressor, the starting current is zero</p> <p>(6) It may change in case of unit with options or customized unit. Refer to dedicated unit's wiring diagram.</p> <p>The data are referred to the unit without additional options. All data are subject to change without notice. For updated information on project base refer to unit specific wiring diagram and unit's nameplate data.</p>						



EWAH~TZ- XR C + OPT159 – BRUSHLESS FANS UP 700 RPM								
MODEL	notes		670	780	840	950	C10	C11
Phases		n	3					
Frequency		Hz	50					
Voltage	(2)	V	400					
Voltage Tolerances min/max		%	-10 / +10					
Nominal Running Current	(1)	A	351,3	405,7	430,0	477,4	505,4	562,6
Max. running current	(3)	A	711	698	767	914	927	1072
Max. current for wire sizing	(4)	A	782	767	844	1005	1020	1179
Maximum starting current	(5)	A	0	0	0	0	0	0
Fan starting method	(6)	-	EC Brushless Motor					
Max running current per fan	(6)	A	1,40					
Total fans running current	(6)	A	19,6	22,4	25,2	30,8	33,6	36,4
Compressor starting method			Variable Frequency Drive					
Max. running current Compressor #1	(6)	A	236	248	276	291	326	367
Max. running current Compressor #2	(6)	A	236	248	276	291	326	367
Main switch size	(6)	A	800	800	1000	1000	1250	1250
Terminal connection	(6)	-	Cables	Cables	Bars	Bars	Bars	Bars
Cable per phase	(6)	-	2x240 mm <sup>2</sup>	2x240 mm <sup>2</sup>	2x300 mm <sup>2</sup>	2x300 mm <sup>2</sup>	2x400 mm <sup>2</sup>	2x400 mm <sup>2</sup>
Short circuit current Icw 1 sec.	(6)	kA	20	20	25	25	25	25
<p>(1) Standard Rating Conditions for Air to water chillers according to EN14511:2 Outdoor Heat exchanger inlet dry bulb temperature 35°; Indoor heat exchanger inlet water temperature 12°C, outlet water temperature 7°C. Fouling factor = 0</p> <p>(2) Voltage unbalance between phases must be within ± 3%.</p> <p>(3) Maximum running current is based on max compressor absorbed current in its envelope and max fans absorbed current.</p> <p>(4) Based on minimum allowed voltage → Max. current for wire sizing = Max. Running current x 1,1</p> <p>(5) In case of inverter driven compressor, the starting current is zero</p> <p>(6) It may change in case of unit with options or customized unit. Refer to dedicated unit's wiring diagram.</p> <p>The data are referred to the unit without additional options. All data are subject to change without notice. For updated information on project base refer to unit specific wiring diagram and unit's nameplate data.</p>								

EWAH~TZ- XR C + OPT159 – BRUSHLESS FANS UP 700 RPM						
MODEL	notes		C12	C13	C14	C15
Phases		n	3			
Frequency		Hz	50			
Voltage	(2)	V	400			
Voltage Tolerances min/max		%	-10 / +10			
Nominal Running Current	(1)	A	629,6	681,3	736,6	803,4
Max. running current	(3)	A	1038	1158	1242	1269
Max. current for wire sizing	(4)	A	1142	1274	1366	1396
Maximum starting current	(5)	A	0	0	0	0
Fan starting method	(6)	-	EC Brushless Motor			
Max running current per fan	(6)	A	1,40			
Total fans running current	(6)	A	33,6	36,4	39,2	42,0
Compressor starting method			Variable Frequency Drive			
Max. running current Compressor #1	(6)	A	388	419	451	484
Max. running current Compressor #2	(6)	A	388	419	451	484
Main switch size	(6)	A	1250	1600	1600	1600
Terminal connection	(6)	-	Bars	Bars	Bars	Bars
Cable per phase	(6)	-	2x400 mm <sup>2</sup>	2x500 mm <sup>2</sup>	2x500 mm <sup>2</sup>	2x500 mm <sup>2</sup>
Short circuit current I <sub>cs</sub> 1 sec.	(6)	kA	25	25	25	25
<p>(1) Standard Rating Conditions for Air to water chillers according to EN14511:2 Outdoor Heat exchanger inlet dry bulb temperature 35°; Indoor heat exchanger inlet water temperature 12°C, outlet water temperature 7°C. Fouling factor = 0</p> <p>(2) Voltage unbalance between phases must be within ± 3%.</p> <p>(3) Maximum running current is based on max compressor absorbed current in its envelope and max fans absorbed current.</p> <p>(4) Based on minimum allowed voltage → Max. current for wire sizing = Max. Running current x 1,1</p> <p>(5) In case of inverter driven compressor, the starting current is zero</p> <p>(6) It may change in case of unit with options or customized unit. Refer to dedicated unit's wiring diagram.</p> <p>The data are referred to the unit without additional options. All data are subject to change without notice. For updated information on project base refer to unit specific wiring diagram and unit's nameplate data.</p>						

EWAD~TZ- SS C + OPT158 – BRUSHLESS FANS UP 900 RPM								
MODEL	notes		H11	H12	H13	C15	C16	H17
Phases		n	3					
Frequency		Hz	50					
Voltage	(2)	V	400					
Voltage Tolerances min/max		%	-10 / +10					
<b>Nominal Running Current</b>								
Nominal Running Current	(1)	A	607,3	652,0	690,3	771,8	838,4	913,5
<b>Max. running current</b>								
Max. running current	(3)	A	1015	1050	1064	1294	1320	1442
<b>Max. current for wire sizing</b>								
Max. current for wire sizing	(4)	A	1116	1155	1170	1424	1452	1586
<b>Maximum starting current</b>								
Maximum starting current	(5)	A	0	0	0	0	0	0
<b>Fan starting method</b>								
Fan starting method	(6)	-	EC Brushless Motor					
<b>Max running current per fan</b>								
Max running current per fan	(6)	A	2,22					
<b>Total fans running current</b>								
Total fans running current	(6)	A	48,8	48,8	53,3	53,3	57,7	62,2
<b>Compressor starting method</b>								
Compressor starting method			Variable Frequency Drive					
<b>Max. running current Compressor #1</b>								
Max. running current Compressor #1	(6)	A	367	388	411	480	521	562
<b>Max. running current Compressor #2</b>								
Max. running current Compressor #2	(6)	A	367	388	411	480	521	562
<b>Main switch size</b>								
Main switch size	(6)	A	1250	1250	1250	1600	1600	2000
<b>Terminal connection</b>								
Terminal connection	(6)	-	Bars	Bars	Bars	Bars	Bars	Bars
<b>Cable per phase</b>								
Cable per phase	(6)	-	2x400 mm <sup>2</sup>	2x400 mm <sup>2</sup>	2x400 mm <sup>2</sup>	2x500 mm <sup>2</sup>	2x500 mm <sup>2</sup>	3x500 mm <sup>2</sup>
<b>Short circuit current I<sub>cs</sub> 1 sec.</b>								
Short circuit current I <sub>cs</sub> 1 sec.	(6)	kA	25	25	25	25	25	25
<p>(7) Standard Rating Conditions for Air to water chillers according to EN14511:2 Outdoor Heat exchanger inlet dry bulb temperature 35°; Indoor heat exchanger inlet water temperature 12°C, outlet water temperature 7°C. Fouling factor = 0</p> <p>(8) Voltage unbalance between phases must be within ± 3%.</p> <p>(9) Maximum running current is based on max compressor absorbed current in its envelope and max fans absorbed current.</p> <p>(10) Based on minimum allowed voltage → Max. current for wire sizing = Max. Running current x 1,1</p> <p>(11) In case of inverter driven compressor, the starting current is zero</p> <p>(12) It may change in case of unit with options or customized unit. Refer to dedicated unit's wiring diagram.</p>								
<p>The data are referred to the unit without additional options.</p> <p>All data are subject to change without notice. For updated information on project base refer to unit specific wiring diagram and unit's nameplate data.</p>								

EWAD~TZ- SS C + OPT158 – BRUSHLESS FANS UP 900 RPM				
MODEL	notes		H18	H19
Phases		n	3	
Frequency		Hz	50	
Voltage	(2)	V	400	
Voltage Tolerances min/max		%	-10 / +10	
<b>Nominal Running Current</b>				
Nominal Running Current	(1)	A	990,8	1096
<b>Max. running current</b>				
Max. running current	(3)	A	1551	1649
<b>Max. current for wire sizing</b>				
Max. current for wire sizing	(4)	A	1706	1814
<b>Maximum starting current</b>				
Maximum starting current	(5)	A	0	0
<b>Fan starting method</b>				
Fan starting method	(6)	-	EC Brushless Motor	
<b>Max running current per fan</b>				
Max running current per fan	(6)	A	2,22	
<b>Total fans running current</b>				
Total fans running current	(6)	A	66,6	66,6
<b>Compressor starting method</b>				
Compressor starting method			Variable Frequency Drive	
<b>Max. running current Compressor #1</b>				
Max. running current Compressor #1	(6)	A	605	649
<b>Max. running current Compressor #2</b>				
Max. running current Compressor #2	(6)	A	605	649
<b>Main switch size</b>				
Main switch size	(6)	A	2000	2000
<b>Terminal connection</b>				
Terminal connection	(6)	-	Bars	Bars
<b>Cable per phase</b>				
Cable per phase	(6)	-	3x500 mm <sup>2</sup>	3x500 mm <sup>2</sup>
<b>Short circuit current I<sub>cw</sub> 1 sec.</b>				
Short circuit current I <sub>cw</sub> 1 sec.	(6)	kA	25	25
<p>(1) Standard Rating Conditions for Air to water chillers according to EN14511:2 Outdoor Heat exchanger inlet dry bulb temperature 35°; Indoor heat exchanger inlet water temperature 12°C, outlet water temperature 7°C. Fouling factor = 0</p> <p>(2) Voltage unbalance between phases must be within ± 3%.</p> <p>(3) Maximum running current is based on max compressor absorbed current in its envelope and max fans absorbed current.</p> <p>(4) Based on minimum allowed voltage → Max. current for wire sizing = Max. Running current x 1,1</p> <p>(5) In case of inverter driven compressor, the starting current is zero</p> <p>(6) It may change in case of unit with options or customized unit. Refer to dedicated unit's wiring diagram.</p>				
<p>The data are referred to the unit without additional options.  All data are subject to change without notice. For updated information on project base refer to unit specific wiring diagram and unit's nameplate data.</p>				

EWAD~TZ- SL C + OPT158 – BRUSHLESS FANS UP 900 RPM								
MODEL	notes		H11	H12	H13	C15	C16	H17
Phases		n	3					
Frequency		Hz	50					
Voltage	(2)	V	400					
Voltage Tolerances min/max		%	-10 / +10					
Nominal Running Current	(1)	A	607,3	652,0	690,3	771,8	838,4	913,5
Max. running current	(3)	A	1015	1050	1064	1294	1320	1442
Max. current for wire sizing	(4)	A	1116	1155	1170	1424	1452	1586
Maximum starting current	(5)	A	0	0	0	0	0	0
Fan starting method	(6)	-	EC Brushless Motor					
Max running current per fan	(6)	A	2,22					
Total fans running current	(6)	A	48,8	48,8	53,3	53,3	57,7	62,2
Compressor starting method			Variable Frequency Drive					
Max. running current Compressor #1	(6)	A	367	388	411	480	521	562
Max. running current Compressor #2	(6)	A	367	388	411	480	521	562
Main switch size	(6)	A	1250	1250	1250	1600	1600	2000
Terminal connection	(6)	-	Bars	Bars	Bars	Bars	Bars	Bars
Cable per phase	(6)	-	2x400 mm <sup>2</sup>	2x400 mm <sup>2</sup>	2x400 mm <sup>2</sup>	2x500 mm <sup>2</sup>	2x500 mm <sup>2</sup>	3x500 mm <sup>2</sup>
Short circuit current I <sub>cw</sub> 1 sec.	(6)	kA	25	25	25	25	25	25
<p>(1) Standard Rating Conditions for Air to water chillers according to EN14511:2 Outdoor Heat exchanger inlet dry bulb temperature 35°; Indoor heat exchanger inlet water temperature 12°C, outlet water temperature 7°C. Fouling factor = 0</p> <p>(2) Voltage unbalance between phases must be within ± 3%.</p> <p>(3) Maximum running current is based on max compressor absorbed current in its envelope and max fans absorbed current.</p> <p>(4) Based on minimum allowed voltage → Max. current for wire sizing = Max. Running current x 1,1</p> <p>(5) In case of inverter driven compressor, the starting current is zero</p> <p>(6) It may change in case of unit with options or customized unit. Refer to dedicated unit's wiring diagram.</p> <p>The data are referred to the unit without additional options. All data are subject to change without notice. For updated information on project base refer to unit specific wiring diagram and unit's nameplate data.</p>								

EWAD~TZ- SL C + OPT158 – BRUSHLESS FANS UP 900 RPM				
MODEL	notes		H18	H19
Phases		n	3	
Frequency		Hz	50	
Voltage	(2)	V	400	
Voltage Tolerances min/max		%	-10 / +10	
<b>Nominal Running Current</b>				
Nominal Running Current	(1)	A	990,8	1096
<b>Max. running current</b>				
Max. running current	(3)	A	1551	1649
<b>Max. current for wire sizing</b>				
Max. current for wire sizing	(4)	A	1706	1814
<b>Maximum starting current</b>				
Maximum starting current	(5)	A	0	0
<b>Fan starting method</b>				
Fan starting method	(6)	-	EC Brushless Motor	
<b>Max running current per fan</b>				
Max running current per fan	(6)	A	2,22	
<b>Total fans running current</b>				
Total fans running current	(6)	A	66,6	66,6
<b>Compressor starting method</b>				
Compressor starting method			Variable Frequency Drive	
<b>Max. running current Compressor #1</b>				
Max. running current Compressor #1	(6)	A	605	649
<b>Max. running current Compressor #2</b>				
Max. running current Compressor #2	(6)	A	605	649
<b>Main switch size</b>				
Main switch size	(6)	A	2000	2000
<b>Terminal connection</b>				
Terminal connection	(6)	-	Bars	Bars
<b>Cable per phase</b>				
Cable per phase	(6)	-	3x500 mm <sup>2</sup>	3x500 mm <sup>2</sup>
<b>Short circuit current I<sub>cw</sub> 1 sec.</b>				
Short circuit current I <sub>cw</sub> 1 sec.	(6)	kA	25	25
<p>(1) Standard Rating Conditions for Air to water chillers according to EN14511:2 Outdoor Heat exchanger inlet dry bulb temperature 35°; Indoor heat exchanger inlet water temperature 12°C, outlet water temperature 7°C. Fouling factor = 0</p> <p>(2) Voltage unbalance between phases must be within ± 3%.</p> <p>(3) Maximum running current is based on max compressor absorbed current in its envelope and max fans absorbed current.</p> <p>(4) Based on minimum allowed voltage → Max. current for wire sizing = Max. Running current x 1,1</p> <p>(5) In case of inverter driven compressor, the starting current is zero</p> <p>(6) It may change in case of unit with options or customized unit. Refer to dedicated unit's wiring diagram.</p>				
<p>The data are referred to the unit without additional options. All data are subject to change without notice. For updated information on project base refer to unit specific wiring diagram and unit's nameplate data.</p>				

EWAD~TZ- XS C + OPT158 – BRUSHLESS FANS UP 900 RPM								
MODEL	notes		C11	C12	H12	C14	C15	H16
Phases		n	NA			3		
Frequency		Hz				50		
Voltage	(2)	V				400		
Voltage Tolerances min/max		%				-10/ +10		
Nominal Running Current	(1)	A	NA			690,6	757,6	821,8
Max. running current	(3)	A	NA			1205	1246	1333
Max. current for wire sizing	(4)	A				1326	1371	1467
Maximum starting current	(5)	A				0	0	0
Fan starting method	(6)	-	NA			EC Brushless Motor		
Max running current per fan	(6)	A				2,22		
Total fans running current	(6)	A				53,3	57,7	62,2
Compressor starting method			NA			Variable Frequency Drive		
Max. running current Compressor #1	(6)	A				440	480	521
Max. running current Compressor #2	(6)	A				440	480	521
Main switch size	(6)	A	NA			1600	1600	1600
Terminal connection	(6)	-				Bars	Bars	Bars
Cable per phase	(6)	-				2x500 mm <sup>2</sup>	2x500 mm <sup>2</sup>	2x500 mm <sup>2</sup>
Short circuit current I <sub>cw</sub> 1 sec.	(6)	kA				25	25	25
<p>(1) Standard Rating Conditions for Air to water chillers according to EN14511:2 Outdoor Heat exchanger inlet dry bulb temperature 35°; Indoor heat exchanger inlet water temperature 12°C, outlet water temperature 7°C. Fouling factor = 0</p> <p>(2) Voltage unbalance between phases must be within ± 3%.</p> <p>(3) Maximum running current is based on max compressor absorbed current in its envelope and max fans absorbed current.</p> <p>(4) Based on minimum allowed voltage → Max. current for wire sizing = Max. Running current x 1,1</p> <p>(5) In case of inverter driven compressor, the starting current is zero</p> <p>(6) It may change in case of unit with options or customized unit. Refer to dedicated unit's wiring diagram.</p> <p>The data are referred to the unit without additional options. All data are subject to change without notice. For updated information on project base refer to unit specific wiring diagram and unit's nameplate data.</p>								

EWAD~TZ- XS C + OPT158 – BRUSHLESS FANS UP 900 RPM			
MODEL	notes		H17
Phases		n	3
Frequency		Hz	50
Voltage	(2)	V	400
Voltage Tolerances min/max		%	-10 / +10
<b>Nominal Running Current</b>			
Nominal Running Current	(1)	A	900,7
<b>Max. running current</b>			
Max. running current	(3)	A	1456
<b>Max. current for wire sizing</b>			
Max. current for wire sizing	(4)	A	1601
<b>Maximum starting current</b>			
Maximum starting current	(5)	A	0
<b>Fan starting method</b>			
Fan starting method	(6)	-	EC Brushless Motor
<b>Max running current per fan</b>			
Max running current per fan	(6)	A	2,22
<b>Total fans running current</b>			
Total fans running current	(6)	A	66,6
<b>Compressor starting method</b>			
Compressor starting method			Variable Frequency Drive
<b>Max. running current Compressor #1</b>			
Max. running current Compressor #1	(6)	A	562
<b>Max. running current Compressor #2</b>			
Max. running current Compressor #2	(6)	A	562
<b>Main switch size</b>			
Main switch size	(6)	A	2000
<b>Terminal connection</b>			
Terminal connection	(6)	-	Bars
<b>Cable per phase</b>			
Cable per phase	(6)	-	3x500 mm <sup>2</sup>
<b>Short circuit current I<sub>cw</sub> 1 sec.</b>			
Short circuit current I <sub>cw</sub> 1 sec.	(6)	kA	25
<p>(1) Standard Rating Conditions for Air to water chillers according to EN14511:2 Outdoor Heat exchanger inlet dry bulb temperature 35°; Indoor heat exchanger inlet water temperature 12°C, outlet water temperature 7°C. Fouling factor = 0</p> <p>(2) Voltage unbalance between phases must be within ± 3%.</p> <p>(3) Maximum running current is based on max compressor absorbed current in its envelope and max fans absorbed current.</p> <p>(4) Based on minimum allowed voltage → Max. current for wire sizing = Max. Running current x 1,1</p> <p>(5) In case of inverter driven compressor, the starting current is zero</p> <p>(6) It may change in case of unit with options or customized unit. Refer to dedicated unit's wiring diagram.</p>			
<p>The data are referred to the unit without additional options.  All data are subject to change without notice. For updated information on project base refer to unit specific wiring diagram and unit's nameplate data.</p>			



EWAD~TZ- SR C + OPT159 – BRUSHLESS FANS UP 700 RPM								
MODEL	notes		H11	H12	H13	C15	C16	H17
Phases		n	3					
Frequency		Hz	50					
Voltage	(2)	V	400					
Voltage Tolerances min/max		%	-10 / +10					
<b>Nominal Running Current</b>								
Nominal Running Current	(1)	A	622,0	671,3	707,6	812,7	878,4	952,3
<b>Max. running current</b>								
Max. running current	(3)	A	1015	1050	1064	1294	1320	1442
<b>Max. current for wire sizing</b>								
Max. current for wire sizing	(4)	A	1116	1155	1170	1424	1452	1586
<b>Maximum starting current</b>								
Maximum starting current	(5)	A	0	0	0	0	0	0
<b>Fan starting method</b>								
Fan starting method	(6)	-	EC Brushless Motor					
<b>Max running current per fan</b>								
Max running current per fan	(6)	A	1,40					
<b>Total fans running current</b>								
Total fans running current	(6)	A	30,8	30,8	33,6	33,6	36,4	39,2
<b>Compressor starting method</b>								
Compressor starting method			Variable Frequency Drive					
<b>Max. running current Compressor #1</b>								
Max. running current Compressor #1	(6)	A	367	388	411	480	521	562
<b>Max. running current Compressor #2</b>								
Max. running current Compressor #2	(6)	A	367	388	411	480	521	562
<b>Main switch size</b>								
Main switch size	(6)	A	1250	1250	1250	1600	1600	2000
<b>Terminal connection</b>								
Terminal connection	(6)	-	Bars	Bars	Bars	Bars	Bars	Bars
<b>Cable per phase</b>								
Cable per phase	(6)	-	2x400 mm <sup>2</sup>	2x400 mm <sup>2</sup>	2x400 mm <sup>2</sup>	2x500 mm <sup>2</sup>	2x500 mm <sup>2</sup>	3x500 mm <sup>2</sup>
<b>Short circuit current Icw 1 sec.</b>								
Short circuit current Icw 1 sec.	(6)	kA	25	25	25	25	25	25
<p>(1) Standard Rating Conditions for Air to water chillers according to EN14511:2 Outdoor Heat exchanger inlet dry bulb temperature 35°; Indoor heat exchanger inlet water temperature 12°C, outlet water temperature 7°C. Fouling factor = 0</p> <p>(2) Voltage unbalance between phases must be within ± 3%.</p> <p>(3) Maximum running current is based on max compressor absorbed current in its envelope and max fans absorbed current.</p> <p>(4) Based on minimum allowed voltage → Max. current for wire sizing = Max. Running current x 1,1</p> <p>(5) In case of inverter driven compressor, the starting current is zero</p> <p>(6) It may change in case of unit with options or customized unit. Refer to dedicated unit's wiring diagram.</p>								
<p>The data are referred to the unit without additional options.</p> <p>All data are subject to change without notice. For updated information on project base refer to unit specific wiring diagram and unit's nameplate data.</p>								

EWAD~TZ- SR C + OPT159 – BRUSHLESS FANS UP 700 RPM				
MODEL	notes		H18	H19
Phases		n	3	
Frequency		Hz	50	
Voltage	(2)	V	400	
Voltage Tolerances min/max		%	-10 / +10	
<b>Nominal Running Current</b>				
Nominal Running Current	(1)	A	1029	1143
<b>Max. running current</b>				
Max. running current	(3)	A	1551	1649
<b>Max. current for wire sizing</b>				
Max. current for wire sizing	(4)	A	1706	1814
<b>Maximum starting current</b>				
Maximum starting current	(5)	A	0	0
<b>Fan starting method</b>				
Fan starting method	(6)	-	EC Brushless Motor	
<b>Max running current per fan</b>				
Max running current per fan	(6)	A	1,40	
<b>Total fans running current</b>				
Total fans running current	(6)	A	42,0	42,0
<b>Compressor starting method</b>				
Compressor starting method			Variable Frequency Drive	
<b>Max. running current Compressor #1</b>				
Max. running current Compressor #1	(6)	A	605	649
<b>Max. running current Compressor #2</b>				
Max. running current Compressor #2	(6)	A	605	649
<b>Main switch size</b>				
Main switch size	(6)	A	2000	2000
<b>Terminal connection</b>				
Terminal connection	(6)	-	Bars	Bars
<b>Cable per phase</b>				
Cable per phase	(6)	-	3x500 mm <sup>2</sup>	3x500 mm <sup>2</sup>
<b>Short circuit current I<sub>cw</sub> 1 sec.</b>				
Short circuit current I <sub>cw</sub> 1 sec.	(6)	kA	25	25
<p>(1) Standard Rating Conditions for Air to water chillers according to EN14511:2 Outdoor Heat exchanger inlet dry bulb temperature 35°; Indoor heat exchanger inlet water temperature 12°C, outlet water temperature 7°C. Fouling factor = 0</p> <p>(2) Voltage unbalance between phases must be within ± 3%.</p> <p>(3) Maximum running current is based on max compressor absorbed current in its envelope and max fans absorbed current.</p> <p>(4) Based on minimum allowed voltage → Max. current for wire sizing = Max. Running current x 1,1</p> <p>(5) In case of inverter driven compressor, the starting current is zero</p> <p>(6) It may change in case of unit with options or customized unit. Refer to dedicated unit's wiring diagram.</p> <p>The data are referred to the unit without additional options. All data are subject to change without notice. For updated information on project base refer to unit specific wiring diagram and unit's nameplate data.</p>				

EWAD~TZ- XS C + OPT159 – BRUSHLESS FANS UP 700 RPM								
MODEL	notes		C11	C12	H12	C14	C15	H16
Phases		n	3			NA		
Frequency		Hz	50					
Voltage	(2)	V	400					
Voltage Tolerances min/max		%	-10/ +10					
Nominal Running Current	(1)	A	571,7	606,7	642,4	NA		
Max. running current	(3)	A	1021	1028	1062	NA		
Max. current for wire sizing	(4)	A	1123	1131	1168			
Maximum starting current	(5)	A	0	0	0			
Fan starting method	(6)	-	EC Brushless Motor			NA		
Max running current per fan	(6)	A	1,40					
Total fans running current	(6)	A	30,8	33,6	36,4			
Compressor starting method			Variable Frequency Drive			NA		
Max. running current Compressor #1	(6)	A	370	367	388			
Max. running current Compressor #2	(6)	A	370	367	388			
Main switch size	(6)	A	1250	1250	1250	NA		
Terminal connection	(6)	-	Bars	Bars	Bars			
Cable per phase	(6)	-	2x400 mm <sup>2</sup>	2x400 mm <sup>2</sup>	2x400 mm <sup>2</sup>			
Short circuit current I <sub>cs</sub> 1 sec.	(6)	kA	25	25	25			
<p>(1) Standard Rating Conditions for Air to water chillers according to EN14511:2 Outdoor Heat exchanger inlet dry bulb temperature 35°; Indoor heat exchanger inlet water temperature 12°C, outlet water temperature 7°C. Fouling factor = 0</p> <p>(2) Voltage unbalance between phases must be within ± 3%.</p> <p>(3) Maximum running current is based on max compressor absorbed current in its envelope and max fans absorbed current.</p> <p>(4) Based on minimum allowed voltage → Max. current for wire sizing = Max. Running current x 1,1</p> <p>(5) In case of inverter driven compressor, the starting current is zero</p> <p>(6) It may change in case of unit with options or customized unit. Refer to dedicated unit's wiring diagram.</p> <p>The data are referred to the unit without additional options. All data are subject to change without notice. For updated information on project base refer to unit specific wiring diagram and unit's nameplate data.</p>								

EWAD~TZ- XS C + OPT159 – BRUSHLESS FANS UP 700 RPM			
MODEL	notes		H17
Phases		n	NA
Frequency		Hz	
Voltage	(2)	V	
Voltage Tolerances min/max		%	
Nominal Running Current	(1)	A	NA
Max. running current	(3)	A	NA
Max. current for wire sizing	(4)	A	
Maximum starting current	(5)	A	
Fan starting method	(6)	-	NA
Max running current per fan	(6)	A	
Total fans running current	(6)	A	
Compressor starting method			NA
Max. running current Compressor #1	(6)	A	
Max. running current Compressor #2	(6)	A	
Main switch size	(6)	A	NA
Terminal connection	(6)	-	
Cable per phase	(6)	-	
Short circuit current Icw 1 sec.	(6)	kA	
<p>(1) Standard Rating Conditions for Air to water chillers according to EN14511:2 Outdoor Heat exchanger inlet dry bulb temperature 35°; Indoor heat exchanger inlet water temperature 12°C, outlet water temperature 7°C. Fouling factor = 0</p> <p>(2) Voltage unbalance between phases must be within ± 3%.</p> <p>(3) Maximum running current is based on max compressor absorbed current in its envelope and max fans absorbed current.</p> <p>(4) Based on minimum allowed voltage → Max. current for wire sizing = Max. Running current x 1,1</p> <p>(5) In case of inverter driven compressor, the starting current is zero</p> <p>(6) It may change in case of unit with options or customized unit. Refer to dedicated unit's wiring diagram.</p> <p>The data are referred to the unit without additional options.                      All data are subject to change without notice. For updated information on project base refer to unit specific wiring diagram and unit's nameplate data.</p>			

EWAD~TZ- XR C + OPT159 – BRUSHLESS FANS UP 700 RPM								
MODEL	notes		C11	C12	H12	C14	C15	H16
Phases		n	3					
Frequency		Hz	50					
Voltage	(2)	V	400					
Voltage Tolerances min/max		%	-10/ +10					
Nominal Running Current	(1)	A	575,3	610,6	646,0	721,7	789,8	853,8
Max. running current	(3)	A	1021	1028	1062	1205	1246	1333
Max. current for wire sizing	(4)	A	1123	1131	1168	1326	1371	1467
Maximum starting current	(5)	A	0	0	0	0	0	0
Fan starting method	(6)	-	EC Brushless Motor					
Max running current per fan	(6)	A	1,40					
Total fans running current	(6)	A	30,8	33,6	36,4	33,6	36,4	39,2
Compressor starting method			Variable Frequency Drive					
Max. running current Compressor #1	(6)	A	370	367	388	440	480	521
Max. running current Compressor #2	(6)	A	370	367	388	440	480	521
Main switch size	(6)	A	1250	1250	1250	1600	1600	1600
Terminal connection	(6)	-	Bars	Bars	Bars	Bars	Bars	Bars
Cable per phase	(6)	-	2x400 mm <sup>2</sup>	2x400 mm <sup>2</sup>	2x400 mm <sup>2</sup>	2x500 mm <sup>2</sup>	2x500 mm <sup>2</sup>	2x500 mm <sup>2</sup>
Short circuit current I <sub>cw</sub> 1 sec.	(6)	kA	25	25	25	25	25	25
<p>(1) Standard Rating Conditions for Air to water chillers according to EN14511:2 Outdoor Heat exchanger inlet dry bulb temperature 35°; Indoor heat exchanger inlet water temperature 12°C, outlet water temperature 7°C. Fouling factor = 0</p> <p>(2) Voltage unbalance between phases must be within ± 3%.</p> <p>(3) Maximum running current is based on max compressor absorbed current in its envelope and max fans absorbed current.</p> <p>(4) Based on minimum allowed voltage → Max. current for wire sizing = Max. Running current x 1,1</p> <p>(5) In case of inverter driven compressor, the starting current is zero</p> <p>(6) It may change in case of unit with options or customized unit. Refer to dedicated unit's wiring diagram.</p> <p>The data are referred to the unit without additional options. All data are subject to change without notice. For updated information on project base refer to unit specific wiring diagram and unit's nameplate data.</p>								

EWAD~TZ- XR C + OPT159 – BRUSHLESS FANS UP 700 RPM			
MODEL	notes		H17
Phases		n	3
Frequency		Hz	50
Voltage	(2)	V	400
Voltage Tolerances min/max		%	-10 / +10
<b>Nominal Running Current</b>			
Nominal Running Current	(1)	A	931,8
<b>Max. running current</b>			
Max. running current	(3)	A	1456
<b>Max. current for wire sizing</b>			
Max. current for wire sizing	(4)	A	1601
<b>Maximum starting current</b>			
Maximum starting current	(5)	A	0
<b>Fan starting method</b>			
Fan starting method	(6)	-	EC Brushless Motor
<b>Max running current per fan</b>			
Max running current per fan	(6)	A	1,40
<b>Total fans running current</b>			
Total fans running current	(6)	A	42,0
<b>Compressor starting method</b>			
Compressor starting method			Variable Frequency Drive
<b>Max. running current Compressor #1</b>			
Max. running current Compressor #1	(6)	A	562
<b>Max. running current Compressor #2</b>			
Max. running current Compressor #2	(6)	A	562
<b>Main switch size</b>			
Main switch size	(6)	A	2000
<b>Terminal connection</b>			
Terminal connection	(6)	-	Bars
<b>Cable per phase</b>			
Cable per phase	(6)	-	3x500 mm <sup>2</sup>
<b>Short circuit current l<sub>cw</sub> 1 sec.</b>			
Short circuit current l <sub>cw</sub> 1 sec.	(6)	kA	25
<p>(1) Standard Rating Conditions for Air to water chillers according to EN14511:2 Outdoor Heat exchanger inlet dry bulb temperature 35°; Indoor heat exchanger inlet water temperature 12°C, outlet water temperature 7°C. Fouling factor = 0</p> <p>(2) Voltage unbalance between phases must be within ± 3%.</p> <p>(3) Maximum running current is based on max compressor absorbed current in its envelope and max fans absorbed current.</p> <p>(4) Based on minimum allowed voltage → Max. current for wire sizing = Max. Running current x 1,1</p> <p>(5) In case of inverter driven compressor, the starting current is zero</p> <p>(6) It may change in case of unit with options or customized unit. Refer to dedicated unit's wiring diagram.</p>			
<p>The data are referred to the unit without additional options.  All data are subject to change without notice. For updated information on project base refer to unit specific wiring diagram and unit's nameplate data.</p>			

EWAH~TZ- SS C + OPT142B – HIGH AMBIENT KIT (OPERATION ABOVE 46°C) ON OFF FANS								
MODEL	notes		710	770	880	940	990	H10
Phases		n	3					
Frequency		Hz	50					
Voltage	(2)	V	400					
Voltage Tolerances min/max		%	-10 / +10					
Nominal Running Current	(1)	A	408,6	433,3	493,5	521,5	549,9	579,6
Max. running current	(3)	A	674	711	879	893	907	949
Max. current for wire sizing	(4)	A	741	782	967	982	997	1044
Maximum starting current	(5)	A	0	0	0	0	0	0
Fan starting method	(6)	-	D.O.L.					
Max running current per fan	(6)	A	4					
Total fans running current	(6)	A	56	56	64	72	80	88
Compressor starting method			Variable Frequency Drive					
Max. running current Compressor #1	(6)	A	246	262	291	308	326	345
Max. running current Compressor #2	(6)	A	246	262	291	308	326	345
Main switch size	(6)	A	1000	1000	1000	1250	1250	1250
Terminal connection	(6)	-	Bars	Bars	Bars	Bars	Bars	Bars
Cable per phase	(6)	-	2x300 mm <sup>2</sup>	2x300 mm <sup>2</sup>	2x300 mm <sup>2</sup>	2x400 mm <sup>2</sup>	2x400 mm <sup>2</sup>	2x400 mm <sup>2</sup>
Short circuit current Icw 1 sec.	(6)	kA	25	25	25	25	25	25
<p>(1) Standard Rating Conditions for Air to water chillers according to EN14511:2 Outdoor Heat exchanger inlet dry bulb temperature 35°; Indoor heat exchanger inlet water temperature 12°C, outlet water temperature 7°C. Fouling factor = 0</p> <p>(2) Voltage unbalance between phases must be within ± 3%.</p> <p>(3) Maximum running current is based on max compressor absorbed current in its envelope and max fans absorbed current.</p> <p>(4) Based on minimum allowed voltage → Max. current for wire sizing = Max. Running current x 1,1</p> <p>(5) In case of inverter driven compressor, the starting current is zero</p> <p>(6) It may change in case of unit with options or customized unit. Refer to dedicated unit's wiring diagram.</p> <p>The data are referred to the unit without additional options. All data are subject to change without notice. For updated information on project base refer to unit specific wiring diagram and unit's nameplate data.</p>								

EWAH~TZ- SS C + OPT142B – HIGH AMBIENT KIT (OPERATION ABOVE 46°C) ON OFF FANS								
MODEL	notes		C11	C12	C13	C14	C15	C16
Phases		n	3					
Frequency		Hz	50					
Voltage	(2)	V	400					
Voltage Tolerances min/max		%	-10 / +10					
Nominal Running Current	(1)	A	612,7	668,8	718,8	780,9	848,9	934,8
Max. running current	(3)	A	1058	1072	1144	1228	1315	1333
Max. current for wire sizing	(4)	A	1164	1179	1259	1351	1447	1467
Maximum starting current	(5)	A	0	0	0	0	0	0
Fan starting method	(6)	-	D.O.L.					
Max running current per fan	(6)	A	4					
Total fans running current	(6)	A	96	104	96	104	112	120
Compressor starting method			Variable Frequency Drive					
Max. running current Compressor #1	(6)	A	367	415	419	451	484	518
Max. running current Compressor #2	(6)	A	367	415	419	451	484	518
Main switch size	(6)	A	1600	1600	1600	1600	2000	2000
Terminal connection	(6)	-	Bars	Bars	Bars	Bars	Bars	Bars
Cable per phase	(6)	-	2x500 mm <sup>2</sup>	2x500 mm <sup>2</sup>	2x500 mm <sup>2</sup>	2x500 mm <sup>2</sup>	3x500 mm <sup>2</sup>	3x500 mm <sup>2</sup>
Short circuit current I <sub>cw</sub> 1 sec.	(6)	kA	25	25	25	25	25	25
<p>(1) Standard Rating Conditions for Air to water chillers according to EN14511:2 Outdoor Heat exchanger inlet dry bulb temperature 35°; Indoor heat exchanger inlet water temperature 12°C, outlet water temperature 7°C. Fouling factor = 0</p> <p>(2) Voltage unbalance between phases must be within ± 3%.</p> <p>(3) Maximum running current is based on max compressor absorbed current in its envelope and max fans absorbed current.</p> <p>(4) Based on minimum allowed voltage → Max. current for wire sizing = Max. Running current x 1,1</p> <p>(5) In case of inverter driven compressor, the starting current is zero</p> <p>(6) It may change in case of unit with options or customized unit. Refer to dedicated unit's wiring diagram.</p> <p>The data are referred to the unit without additional options. All data are subject to change without notice. For updated information on project base refer to unit specific wiring diagram and unit's nameplate data.</p>								



EWAH~TZ- SL C + OPT142B – HIGH AMBIENT KIT (OPERATION ABOVE 46°C) ON OFF FANS								
MODEL	notes		710	770	880	940	990	H10
Phases		n	3					
Frequency		Hz	50					
Voltage	(2)	V	400					
Voltage Tolerances min/max		%	-10 / +10					
Nominal Running Current	(1)	A	408,6	433,3	493,5	521,5	549,9	579,6
Max. running current	(3)	A	674	711	879	893	907	949
Max. current for wire sizing	(4)	A	741	782	967	982	997	1044
Maximum starting current	(5)	A	0	0	0	0	0	0
Fan starting method	(6)	-	D.O.L.					
Max running current per fan	(6)	A	4					
Total fans running current	(6)	A	56	56	64	72	80	88
Compressor starting method			Variable Frequency Drive					
Max. running current Compressor #1	(6)	A	246	262	291	308	326	345
Max. running current Compressor #2	(6)	A	246	262	291	308	326	345
Main switch size	(6)	A	1000	1000	1000	1250	1250	1250
Terminal connection	(6)	-	Bars	Bars	Bars	Bars	Bars	Bars
Cable per phase	(6)	-	2x300 mm <sup>2</sup>	2x300 mm <sup>2</sup>	2x300 mm <sup>2</sup>	2x400 mm <sup>2</sup>	2x400 mm <sup>2</sup>	2x400 mm <sup>2</sup>
Short circuit current Icw 1 sec.	(6)	kA	25	25	25	25	25	25
<p>(1) Standard Rating Conditions for Air to water chillers according to EN14511:2 Outdoor Heat exchanger inlet dry bulb temperature 35°; Indoor heat exchanger inlet water temperature 12°C, outlet water temperature 7°C. Fouling factor = 0</p> <p>(2) Voltage unbalance between phases must be within ± 3%.</p> <p>(3) Maximum running current is based on max compressor absorbed current in its envelope and max fans absorbed current.</p> <p>(4) Based on minimum allowed voltage → Max. current for wire sizing = Max. Running current x 1,1</p> <p>(5) In case of inverter driven compressor, the starting current is zero</p> <p>(6) It may change in case of unit with options or customized unit. Refer to dedicated unit's wiring diagram.</p> <p>The data are referred to the unit without additional options. All data are subject to change without notice. For updated information on project base refer to unit specific wiring diagram and unit's nameplate data.</p>								

<b>EWAH~TZ- SL C + OPT142B – HIGH AMBIENT KIT (OPERATION ABOVE 46°C) ON OFF FANS</b>								
<b>MODEL</b>	<b>notes</b>		<b>C11</b>	<b>C12</b>	<b>C13</b>	<b>C14</b>	<b>C15</b>	<b>C16</b>
Phases		n	3					
Frequency		Hz	50					
Voltage	(2)	V	400					
Voltage Tolerances min/max		%	-10 / +10					
<b>Nominal Running Current</b>								
Nominal Running Current	(1)	A	612,7	668,8	718,8	780,9	848,9	934,8
<b>Max. running current</b>								
Max. running current	(3)	A	1058	1072	1144	1228	1315	1333
<b>Max. current for wire sizing</b>								
Max. current for wire sizing	(4)	A	1164	1179	1259	1351	1447	1467
<b>Maximum starting current</b>								
Maximum starting current	(5)	A	0	0	0	0	0	0
<b>Fan starting method</b>								
Fan starting method	(6)	-	D.O.L.					
<b>Max running current per fan</b>								
Max running current per fan	(6)	A	4					
<b>Total fans running current</b>								
Total fans running current	(6)	A	96	104	96	104	112	120
<b>Compressor starting method</b>								
Compressor starting method			Variable Frequency Drive					
<b>Max. running current Compressor #1</b>								
Max. running current Compressor #1	(6)	A	367	415	419	451	484	518
<b>Max. running current Compressor #2</b>								
Max. running current Compressor #2	(6)	A	367	415	419	451	484	518
<b>Main switch size</b>								
Main switch size	(6)	A	1600	1600	1600	1600	2000	2000
<b>Terminal connection</b>								
Terminal connection	(6)	-	Bars	Bars	Bars	Bars	Bars	Bars
<b>Cable per phase</b>								
Cable per phase	(6)	-	2x500 mm <sup>2</sup>	2x500 mm <sup>2</sup>	2x500 mm <sup>2</sup>	2x500 mm <sup>2</sup>	3x500 mm <sup>2</sup>	3x500 mm <sup>2</sup>
<b>Short circuit current Icw 1 sec.</b>								
Short circuit current Icw 1 sec.	(6)	kA	25	25	25	25	25	25
<p>(1) Standard Rating Conditions for Air to water chillers according to EN14511:2 Outdoor Heat exchanger inlet dry bulb temperature 35°; Indoor heat exchanger inlet water temperature 12°C, outlet water temperature 7°C. Fouling factor = 0</p> <p>(2) Voltage unbalance between phases must be within ± 3%.</p> <p>(3) Maximum running current is based on max compressor absorbed current in its envelope and max fans absorbed current.</p> <p>(4) Based on minimum allowed voltage → Max. current for wire sizing = Max. Running current x 1,1</p> <p>(5) In case of inverter driven compressor, the starting current is zero</p> <p>(6) It may change in case of unit with options or customized unit. Refer to dedicated unit's wiring diagram.</p> <p>The data are referred to the unit without additional options. All data are subject to change without notice. For updated information on project base refer to unit specific wiring diagram and unit's nameplate data.</p>								

EWAH~TZ- SR C + OPT142C – HIGH AMBIENT KIT (OPERATION ABOVE 46°C) BRS FANS								
MODEL	notes		710	770	880	940	990	H10
Phases		n	3					
Frequency		Hz	50					
Voltage	(2)	V	400					
Voltage Tolerances min/max		%	-10 / +10					
Nominal Running Current	(1)	A	398,0	420,3	480,1	507,9	536,5	565,6
Max. running current	(3)	A	674	711	880	893	907	949
Max. current for wire sizing	(4)	A	742	782	967	982	997	1044
Maximum starting current	(5)	A	0	0	0	0	0	0
Fan starting method	(6)	-	EC Brushless Motor					
Max running current per fan	(6)	A	1,40					
Total fans running current	(6)	A	19,6	19,6	22,4	25,2	28,0	30,8
Compressor starting method			Variable Frequency Drive					
Max. running current Compressor #1	(6)	A	246	262	291	308	326	345
Max. running current Compressor #2	(6)	A	246	262	291	308	326	345
Main switch size	(6)	A	1000	1000	1000	1250	1250	1250
Terminal connection	(6)	-	Bars	Bars	Bars	Bars	Bars	Bars
Cable per phase	(6)	-	2x300 mm <sup>2</sup>	2x300 mm <sup>2</sup>	2x300 mm <sup>2</sup>	2x400 mm <sup>2</sup>	2x400 mm <sup>2</sup>	2x400 mm <sup>2</sup>
Short circuit current I <sub>cw</sub> 1 sec.	(6)	kA	25	25	25	25	25	25
<p>(1) Standard Rating Conditions for Air to water chillers according to EN14511:2 Outdoor Heat exchanger inlet dry bulb temperature 35°; Indoor heat exchanger inlet water temperature 12°C, outlet water temperature 7°C. Fouling factor = 0</p> <p>(2) Voltage unbalance between phases must be within ± 3%.</p> <p>(3) Maximum running current is based on max compressor absorbed current in its envelope and max fans absorbed current.</p> <p>(4) Based on minimum allowed voltage → Max. current for wire sizing = Max. Running current x 1,1</p> <p>(5) In case of inverter driven compressor, the starting current is zero</p> <p>(6) It may change in case of unit with options or customized unit. Refer to dedicated unit's wiring diagram.</p> <p>The data are referred to the unit without additional options. All data are subject to change without notice. For updated information on project base refer to unit specific wiring diagram and unit's nameplate data.</p>								

EWAH~TZ- SR C + OPT142C – HIGH AMBIENT KIT (OPERATION ABOVE 46°C) BRS FANS								
MODEL	notes		C11	C12	C13	C14	C15	C16
Phases		n	3					
Frequency		Hz	50					
Voltage	(2)	V	400					
Voltage Tolerances min/max		%	-10 / +10					
<b>Nominal Running Current</b>								
Nominal Running Current	(1)	A	598,5	653,5	698,7	759,6	827,1	910,6
<b>Max. running current</b>								
Max. running current	(3)	A	1058	1072	1144	1228	1315	1333
<b>Max. current for wire sizing</b>								
Max. current for wire sizing	(4)	A	1164	1179	1258	1351	1447	1466
<b>Maximum starting current</b>								
Maximum starting current	(5)	A	0	0	0	0	0	0
<b>Fan starting method</b>								
Fan starting method	(6)	-	EC Brushless Motor					
<b>Max running current per fan</b>								
Max running current per fan	(6)	A	1,40					
<b>Total fans running current</b>								
Total fans running current	(6)	A	33,6	36,4	33,6	36,4	39,2	42,0
<b>Compressor starting method</b>								
Compressor starting method			Variable Frequency Drive					
<b>Max. running current Compressor #1</b>								
Max. running current Compressor #1	(6)	A	367	415	419	451	484	518
<b>Max. running current Compressor #2</b>								
Max. running current Compressor #2	(6)	A	367	415	419	451	484	518
<b>Main switch size</b>								
Main switch size	(6)	A	1600	1600	1600	1600	2000	2000
<b>Terminal connection</b>								
Terminal connection	(6)	-	Bars	Bars	Bars	Bars	Bars	Bars
<b>Cable per phase</b>								
Cable per phase	(6)	-	2x500 mm <sup>2</sup>	2x500 mm <sup>2</sup>	2x500 mm <sup>2</sup>	2x500 mm <sup>2</sup>	3x500 mm <sup>2</sup>	3x500 mm <sup>2</sup>
<b>Short circuit current Icw 1 sec.</b>								
Short circuit current Icw 1 sec.	(6)	kA	25	25	25	25	25	25
<p>(1) Standard Rating Conditions for Air to water chillers according to EN14511:2 Outdoor Heat exchanger inlet dry bulb temperature 35°; Indoor heat exchanger inlet water temperature 12°C, outlet water temperature 7°C. Fouling factor = 0</p> <p>(2) Voltage unbalance between phases must be within ± 3%.</p> <p>(3) Maximum running current is based on max compressor absorbed current in its envelope and max fans absorbed current.</p> <p>(4) Based on minimum allowed voltage → Max. current for wire sizing = Max. Running current x 1,1</p> <p>(5) In case of inverter driven compressor, the starting current is zero</p> <p>(6) It may change in case of unit with options or customized unit. Refer to dedicated unit's wiring diagram.</p> <p>The data are referred to the unit without additional options. All data are subject to change without notice. For updated information on project base refer to unit specific wiring diagram and unit's nameplate data.</p>								

EWAH~TZ- XS C + OPT142C – HIGH AMBIENT KIT (OPERATION ABOVE 46°C) BRS FANS								
MODEL	notes		670	780	840	950	C10	C11
Phases		n	3					
Frequency		Hz	50					
Voltage	(2)	V	400					
Voltage Tolerances min/max		%	-10 / +10					
Nominal Running Current	(1)	A	357,1	414,6	444,9	504,9	538,3	597,8
Max. running current	(3)	A	711	698	767	914	927	1072
Max. current for wire sizing	(4)	A	782	767	844	1005	1020	1179
Maximum starting current	(5)	A	0	0	0	0	0	0
Fan starting method	(6)	-	EC Brushless Motor					
Max running current per fan	(6)	A	1,40					
Total fans running current	(6)	A	19,6	22,4	25,2	30,8	33,6	36,4
Compressor starting method			Variable Frequency Drive					
Max. running current Compressor #1	(6)	A	236	248	276	291	326	367
Max. running current Compressor #2	(6)	A	236	248	276	291	326	367
Main switch size	(6)	A	1000	1000	1000	1250	1250	1600
Terminal connection	(6)	-	Bars	Bars	Bars	Bars	Bars	Bars
Cable per phase	(6)	-	2x300 mm <sup>2</sup>	2x300 mm <sup>2</sup>	2x300 mm <sup>2</sup>	2x400 mm <sup>2</sup>	2x400 mm <sup>2</sup>	2x500 mm <sup>2</sup>
Short circuit current Icw 1 sec.	(6)	kA	25	25	25	25	25	25
<p>(1) Standard Rating Conditions for Air to water chillers according to EN14511:2 Outdoor Heat exchanger inlet dry bulb temperature 35°; Indoor heat exchanger inlet water temperature 12°C, outlet water temperature 7°C. Fouling factor = 0</p> <p>(2) Voltage unbalance between phases must be within ± 3%.</p> <p>(3) Maximum running current is based on max compressor absorbed current in its envelope and max fans absorbed current.</p> <p>(4) Based on minimum allowed voltage → Max. current for wire sizing = Max. Running current x 1,1</p> <p>(5) In case of inverter driven compressor, the starting current is zero</p> <p>(6) It may change in case of unit with options or customized unit. Refer to dedicated unit's wiring diagram.</p> <p>The data are referred to the unit without additional options. All data are subject to change without notice. For updated information on project base refer to unit specific wiring diagram and unit's nameplate data.</p>								

EWAH~TZ- XS C + OPT142C – HIGH AMBIENT KIT (OPERATION ABOVE 46°C) BRS FANS						
MODEL	notes		C12	C13	C14	C15
Phases		n	3			
Frequency		Hz	50			
Voltage	(2)	V	400			
Voltage Tolerances min/max		%	-10 / +10			
Nominal Running Current	(1)	A	636,5	692,6	752,5	821,6
Max. running current	(3)	A	1038	1158	1242	1269
Max. current for wire sizing	(4)	A	1142	1274	1366	1396
Maximum starting current	(5)	A	0	0	0	0
Fan starting method	(6)	-	EC Brushless Motor			
Max running current per fan	(6)	A	2,22			
Total fans running current	(6)	A	53,3	57,7	62,2	66,6
Compressor starting method			Variable Frequency Drive			
Max. running current Compressor #1	(6)	A	388	419	451	484
Max. running current Compressor #2	(6)	A	388	419	451	484
Main switch size	(6)	A	1600	1600	1600	1600
Terminal connection	(6)	-	Bars	Bars	Bars	Bars
Cable per phase	(6)	-	2x500 mm <sup>2</sup>	2x500 mm <sup>2</sup>	2x500 mm <sup>2</sup>	2x500 mm <sup>2</sup>
Short circuit current I <sub>cw</sub> 1 sec.	(6)	kA	25	25	25	25
<p>(1) Standard Rating Conditions for Air to water chillers according to EN14511:2 Outdoor Heat exchanger inlet dry bulb temperature 35°; Indoor heat exchanger inlet water temperature 12°C, outlet water temperature 7°C. Fouling factor = 0</p> <p>(2) Voltage unbalance between phases must be within ± 3%.</p> <p>(3) Maximum running current is based on max compressor absorbed current in its envelope and max fans absorbed current.</p> <p>(4) Based on minimum allowed voltage → Max. current for wire sizing = Max. Running current x 1,1</p> <p>(5) In case of inverter driven compressor, the starting current is zero</p> <p>(6) It may change in case of unit with options or customized unit. Refer to dedicated unit's wiring diagram.</p> <p>The data are referred to the unit without additional options. All data are subject to change without notice. For updated information on project base refer to unit specific wiring diagram and unit's nameplate data.</p>						

EWAH~TZ- XL C + OPT142C – HIGH AMBIENT KIT (OPERATION ABOVE 46°C) BRS FANS								
MODEL	notes		670	780	840	950	C10	C11
Phases		n	3					
Frequency		Hz	50					
Voltage	(2)	V	400					
Voltage Tolerances min/max		%	-10 / +10					
Nominal Running Current	(1)	A	357,1	414,6	444,9	504,9	538,3	597,8
Max. running current	(3)	A	711	698	767	914	927	1072
Max. current for wire sizing	(4)	A	782	768	844	1005	1020	1179
Maximum starting current	(5)	A	0	0	0	0	0	0
Fan starting method	(6)	-	EC Brushless Motor					
Max running current per fan	(6)	A	1,40					
Total fans running current	(6)	A	19,6	22,4	25,2	30,8	33,6	36,4
Compressor starting method			Variable Frequency Drive					
Max. running current Compressor #1	(6)	A	236	248	276	291	326	367
Max. running current Compressor #2	(6)	A	236	248	276	291	326	367
Main switch size	(6)	A	1000	1000	1000	1250	1250	1600
Terminal connection	(6)	-	Bars	Bars	Bars	Bars	Bars	Bars
Cable per phase	(6)	-	2x300 mm <sup>2</sup>	2x300 mm <sup>2</sup>	2x300 mm <sup>2</sup>	2x400 mm <sup>2</sup>	2x400 mm <sup>2</sup>	2x500 mm <sup>2</sup>
Short circuit current I <sub>cw</sub> 1 sec.	(6)	kA	25	25	25	25	25	25
<p>(1) Standard Rating Conditions for Air to water chillers according to EN14511:2 Outdoor Heat exchanger inlet dry bulb temperature 35°; Indoor heat exchanger inlet water temperature 12°C, outlet water temperature 7°C. Fouling factor = 0</p> <p>(2) Voltage unbalance between phases must be within ± 3%.</p> <p>(3) Maximum running current is based on max compressor absorbed current in its envelope and max fans absorbed current.</p> <p>(4) Based on minimum allowed voltage → Max. current for wire sizing = Max. Running current x 1,1</p> <p>(5) In case of inverter driven compressor, the starting current is zero</p> <p>(6) It may change in case of unit with options or customized unit. Refer to dedicated unit's wiring diagram.</p> <p>The data are referred to the unit without additional options. All data are subject to change without notice. For updated information on project base refer to unit specific wiring diagram and unit's nameplate data.</p>								

EWAH~TZ- XL C + OPT142C – HIGH AMBIENT KIT (OPERATION ABOVE 46°C) BRS FANS						
MODEL	notes		C12	C13	C14	C15
Phases		n	3			
Frequency		Hz	50			
Voltage	(2)	V	400			
Voltage Tolerances min/max		%	-10 / +10			
Nominal Running Current	(1)	A	636,5	692,6	752,5	821,6
Max. running current	(3)	A	1038	1158	1242	1269
Max. current for wire sizing	(4)	A	1142	1274	1366	1396
Maximum starting current	(5)	A	0	0	0	0
Fan starting method	(6)	-	EC Brushless Motor			
Max running current per fan	(6)	A	2,22			
Total fans running current	(6)	A	53,3	57,7	62,2	66,6
Compressor starting method			Variable Frequency Drive			
Max. running current Compressor #1	(6)	A	388	419	451	484
Max. running current Compressor #2	(6)	A	388	419	451	484
Main switch size	(6)	A	1600	1600	1600	1600
Terminal connection	(6)	-	Bars	Bars	Bars	Bars
Cable per phase	(6)	-	2x500 mm <sup>2</sup>	2x500 mm <sup>2</sup>	2x500 mm <sup>2</sup>	2x500 mm <sup>2</sup>
Short circuit current I <sub>cw</sub> 1 sec.	(6)	kA	25	25	25	25
<p>(1) Standard Rating Conditions for Air to water chillers according to EN14511:2 Outdoor Heat exchanger inlet dry bulb temperature 35°; Indoor heat exchanger inlet water temperature 12°C, outlet water temperature 7°C. Fouling factor = 0</p> <p>(2) Voltage unbalance between phases must be within ± 3%.</p> <p>(3) Maximum running current is based on max compressor absorbed current in its envelope and max fans absorbed current.</p> <p>(4) Based on minimum allowed voltage → Max. current for wire sizing = Max. Running current x 1,1</p> <p>(5) In case of inverter driven compressor, the starting current is zero</p> <p>(6) It may change in case of unit with options or customized unit. Refer to dedicated unit's wiring diagram.</p> <p>The data are referred to the unit without additional options. All data are subject to change without notice. For updated information on project base refer to unit specific wiring diagram and unit's nameplate data.</p>						



EWAH~TZ- XR C + OPT142C – HIGH AMBIENT KIT (OPERATION ABOVE 46°C) BRS FANS								
MODEL	notes		670	780	840	950	C10	C11
Phases		n	3					
Frequency		Hz	50					
Voltage	(2)	V	400					
Voltage Tolerances min/max		%	-10 / +10					
Nominal Running Current	(1)	A	358,1	416	446,1	506,1	539,7	599,1
Max. running current	(3)	A	711	698	767	914	927	1072
Max. current for wire sizing	(4)	A	782	767	844	1005	1020	1179
Maximum starting current	(5)	A	0	0	0	0	0	0
Fan starting method	(6)	-	EC Brushless Motor					
Max running current per fan	(6)	A	1,40					
Total fans running current	(6)	A	19,6	22,4	25,2	30,8	33,6	36,4
Compressor starting method			Variable Frequency Drive					
Max. running current Compressor #1	(6)	A	236	248	276	291	326	367
Max. running current Compressor #2	(6)	A	236	248	276	291	326	367
Main switch size	(6)	A	1000	1000	1000	1250	1250	1600
Terminal connection	(6)	-	Bars	Bars	Bars	Bars	Bars	Bars
Cable per phase	(6)	-	2x300 mm <sup>2</sup>	2x300 mm <sup>2</sup>	2x300 mm <sup>2</sup>	2x400 mm <sup>2</sup>	2x400 mm <sup>2</sup>	2x500 mm <sup>2</sup>
Short circuit current Icw 1 sec.	(6)	kA	25	25	25	25	25	25
<p>(1) Standard Rating Conditions for Air to water chillers according to EN14511:2 Outdoor Heat exchanger inlet dry bulb temperature 35°; Indoor heat exchanger inlet water temperature 12°C, outlet water temperature 7°C. Fouling factor = 0</p> <p>(2) Voltage unbalance between phases must be within ± 3%.</p> <p>(3) Maximum running current is based on max compressor absorbed current in its envelope and max fans absorbed current.</p> <p>(4) Based on minimum allowed voltage → Max. current for wire sizing = Max. Running current x 1,1</p> <p>(5) In case of inverter driven compressor, the starting current is zero</p> <p>(6) It may change in case of unit with options or customized unit. Refer to dedicated unit's wiring diagram.</p> <p>The data are referred to the unit without additional options. All data are subject to change without notice. For updated information on project base refer to unit specific wiring diagram and unit's nameplate data.</p>								

EWAH~TZ- XR C + OPT142C – HIGH AMBIENT KIT (OPERATION ABOVE 46°C) BRS FANS						
MODEL	notes		C12	C13	C14	C15
Phases		n	3			
Frequency		Hz	50			
Voltage	(2)	V	400			
Voltage Tolerances min/max		%	-10 / +10			
Nominal Running Current	(1)	A	638,9	694,8	755	824,1
Max. running current	(3)	A	1038	1158	1242	1269
Max. current for wire sizing	(4)	A	1142	1274	1366	1396
Maximum starting current	(5)	A	0	0	0	0
Fan starting method	(6)	-	EC Brushless Motor			
Max running current per fan	(6)	A	1,40			
Total fans running current	(6)	A	33,6	36,4	39,2	42,0
Compressor starting method			Variable Frequency Drive			
Max. running current Compressor #1	(6)	A	388	419	451	484
Max. running current Compressor #2	(6)	A	388	419	451	484
Main switch size	(6)	A	1600	1600	1600	1600
Terminal connection	(6)	-	Bars	Bars	Bars	Bars
Cable per phase	(6)	-	2x500 mm <sup>2</sup>	2x500 mm <sup>2</sup>	2x500 mm <sup>2</sup>	2x500 mm <sup>2</sup>
Short circuit current I <sub>cw</sub> 1 sec.	(6)	kA	25	25	25	25
<p>(1) Standard Rating Conditions for Air to water chillers according to EN14511:2 Outdoor Heat exchanger inlet dry bulb temperature 35°; Indoor heat exchanger inlet water temperature 12°C, outlet water temperature 7°C. Fouling factor = 0</p> <p>(2) Voltage unbalance between phases must be within ± 3%.</p> <p>(3) Maximum running current is based on max compressor absorbed current in its envelope and max fans absorbed current.</p> <p>(4) Based on minimum allowed voltage → Max. current for wire sizing = Max. Running current x 1,1</p> <p>(5) In case of inverter driven compressor, the starting current is zero</p> <p>(6) It may change in case of unit with options or customized unit. Refer to dedicated unit's wiring diagram.</p> <p>The data are referred to the unit without additional options. All data are subject to change without notice. For updated information on project base refer to unit specific wiring diagram and unit's nameplate data.</p>						

EWAD~TZ- SS C + OPT142B – HIGH AMBIENT KIT (OPERATION ABOVE 46°C) ON OFF FANS								
MODEL	notes		H11	H12	H13	C15	C16	H17
Phases		n	3					
Frequency		Hz	50					
Voltage	(2)	V	400					
Voltage Tolerances min/max		%	-10 / +10					
Nominal Running Current	(1)	A	648,6	693,5	736,0	816,4	887,1	963,0
Max. running current	(3)	A	1015	1050	1064	1294	1320	1442
Max. current for wire sizing	(4)	A	1117	1155	1170	1423	1452	1586
Maximum starting current	(5)	A	0	0	0	0	0	0
Fan starting method	(6)	-	D.O.L.					
Max running current per fan	(6)	A	4					
Total fans running current	(6)	A	88	88	96	96	104	112
Compressor starting method			Variable Frequency Drive					
Max. running current Compressor #1	(6)	A	367	388	411	480	521	562
Max. running current Compressor #2	(6)	A	367	388	411	480	521	562
Main switch size	(6)	A	1600	1600	1600	2000	2000	2000
Terminal connection	(6)	-	Bars	Bars	Bars	Bars	Bars	Bars
Cable per phase	(6)	-	2x500 mm <sup>2</sup>	2x500 mm <sup>2</sup>	2x500 mm <sup>2</sup>	3x500 mm <sup>2</sup>	3x500 mm <sup>2</sup>	3x500 mm <sup>2</sup>
Short circuit current I <sub>cw</sub> 1 sec.	(6)	kA	25	25	25	25	25	25
<p>(1) Standard Rating Conditions for Air to water chillers according to EN14511:2 Outdoor Heat exchanger inlet dry bulb temperature 35°; Indoor heat exchanger inlet water temperature 12°C, outlet water temperature 7°C. Fouling factor = 0</p> <p>(2) Voltage unbalance between phases must be within ± 3%.</p> <p>(3) Maximum running current is based on max compressor absorbed current in its envelope and max fans absorbed current.</p> <p>(4) Based on minimum allowed voltage → Max. current for wire sizing = Max. Running current x 1,1</p> <p>(5) In case of inverter driven compressor, the starting current is zero</p> <p>(6) It may change in case of unit with options or customized unit. Refer to dedicated unit's wiring diagram.</p> <p>The data are referred to the unit without additional options. All data are subject to change without notice. For updated information on project base refer to unit specific wiring diagram and unit's nameplate data.</p>								

<b>EWAD~TZ- SS C + OPT142B – HIGH AMBIENT KIT (OPERATION ABOVE 46°C) ON OFF FANS</b>				
<b>MODEL</b>	<b>notes</b>		<b>H18</b>	<b>H19</b>
Phases		n	3	
Frequency		Hz	50	
Voltage	(2)	V	400	
Voltage Tolerances min/max		%	-10 / +10	
<b>Nominal Running Current</b>				
Nominal Running Current	(1)	A	1044	1148
<b>Max. running current</b>				
Max. running current	(3)	A	1551	1649
<b>Max. current for wire sizing</b>				
Max. current for wire sizing	(4)	A	1706	1814
<b>Maximum starting current</b>				
Maximum starting current	(5)	A	0	0
<b>Fan starting method</b>				
Fan starting method	(6)	-	D.O.L.	
<b>Max running current per fan</b>				
Max running current per fan	(6)	A	4	
<b>Total fans running current</b>				
Total fans running current	(6)	A	120	120
<b>Compressor starting method</b>				
Compressor starting method			Variable Frequency Drive	
<b>Max. running current Compressor #1</b>				
Max. running current Compressor #1	(6)	A	605	649
<b>Max. running current Compressor #2</b>				
Max. running current Compressor #2	(6)	A	605	649
<b>Main switch size</b>				
Main switch size	(6)	A	2000	2500
<b>Terminal connection</b>				
Terminal connection	(6)	-	Bars	Bars
<b>Cable per phase</b>				
Cable per phase	(6)	-	3x500 mm <sup>2</sup>	4x500 mm <sup>2</sup>
<b>Short circuit current I<sub>cw</sub> 1 sec.</b>				
Short circuit current I <sub>cw</sub> 1 sec.	(6)	kA	25	25
<p>(1) Standard Rating Conditions for Air to water chillers according to EN14511:2 Outdoor Heat exchanger inlet dry bulb temperature 35°; Indoor heat exchanger inlet water temperature 12°C, outlet water temperature 7°C. Fouling factor = 0</p> <p>(2) Voltage unbalance between phases must be within ± 3%.</p> <p>(3) Maximum running current is based on max compressor absorbed current in its envelope and max fans absorbed current.</p> <p>(4) Based on minimum allowed voltage → Max. current for wire sizing = Max. Running current x 1,1</p> <p>(5) In case of inverter driven compressor, the starting current is zero</p> <p>(6) It may change in case of unit with options or customized unit. Refer to dedicated unit's wiring diagram.</p> <p>The data are referred to the unit without additional options. All data are subject to change without notice. For updated information on project base refer to unit specific wiring diagram and unit's nameplate data.</p>				

EWAD~TZ- SL C + OPT142B – HIGH AMBIENT KIT (OPERATION ABOVE 46°C) ON OFF FANS								
MODEL	notes		H11	H12	H13	C15	C16	H17
Phases		n	3					
Frequency		Hz	50					
Voltage	(2)	V	400					
Voltage Tolerances min/max		%	-10 / +10					
Nominal Running Current	(1)	A	646,5	691,1	733,0	813,9	884,0	962,8
Max. running current	(3)	A	1015	1050	1064	1294	1320	1442
Max. current for wire sizing	(4)	A	1117	1155	1170	1423	1452	1586
Maximum starting current	(5)	A	0	0	0	0	0	0
Fan starting method	(6)	-	D.O.L.					
Max running current per fan	(6)	A	4					
Total fans running current	(6)	A	88	88	96	96	104	112
Compressor starting method			Variable Frequency Drive					
Max. running current Compressor #1	(6)	A	367	388	411	480	521	562
Max. running current Compressor #2	(6)	A	367	388	411	480	521	562
Main switch size	(6)	A	1600	1600	1600	2000	2000	2000
Terminal connection	(6)	-	Bars	Bars	Bars	Bars	Bars	Bars
Cable per phase	(6)	-	2x500 mm <sup>2</sup>	2x500 mm <sup>2</sup>	2x500 mm <sup>2</sup>	3x500 mm <sup>2</sup>	3x500 mm <sup>2</sup>	3x500 mm <sup>2</sup>
Short circuit current Icw 1 sec.	(6)	kA	25	25	25	25	25	25
<p>(1) Standard Rating Conditions for Air to water chillers according to EN14511:2 Outdoor Heat exchanger inlet dry bulb temperature 35°; Indoor heat exchanger inlet water temperature 12°C, outlet water temperature 7°C. Fouling factor = 0</p> <p>(2) Voltage unbalance between phases must be within ± 3%.</p> <p>(3) Maximum running current is based on max compressor absorbed current in its envelope and max fans absorbed current.</p> <p>(4) Based on minimum allowed voltage → Max. current for wire sizing = Max. Running current x 1,1</p> <p>(5) In case of inverter driven compressor, the starting current is zero</p> <p>(6) It may change in case of unit with options or customized unit. Refer to dedicated unit's wiring diagram.</p> <p>The data are referred to the unit without additional options. All data are subject to change without notice. For updated information on project base refer to unit specific wiring diagram and unit's nameplate data.</p>								

EWAD~TZ- SL C + OPT142B – HIGH AMBIENT KIT (OPERATION ABOVE 46°C) ON OFF FANS				
MODEL	notes		H18	H19
Phases		n	3	
Frequency		Hz	50	
Voltage	(2)	V	400	
Voltage Tolerances min/max		%	-10 / +10	
<b>Nominal Running Current</b>				
Nominal Running Current	(1)	A	1044	1149
<b>Max. running current</b>				
Max. running current	(3)	A	1551	1649
<b>Max. current for wire sizing</b>				
Max. current for wire sizing	(4)	A	1706	1814
<b>Maximum starting current</b>				
Maximum starting current	(5)	A	0	0
<b>Fan starting method</b>				
Fan starting method	(6)	-	D.O.L.	
<b>Max running current per fan</b>				
Max running current per fan	(6)	A	4	
<b>Total fans running current</b>				
Total fans running current	(6)	A	120	120
<b>Compressor starting method</b>				
Compressor starting method			Variable Frequency Drive	
<b>Max. running current Compressor #1</b>				
Max. running current Compressor #1	(6)	A	605	649
<b>Max. running current Compressor #2</b>				
Max. running current Compressor #2	(6)	A	605	649
<b>Main switch size</b>				
Main switch size	(6)	A	2000	2500
<b>Terminal connection</b>				
Terminal connection	(6)	-	Bars	Bars
<b>Cable per phase</b>				
Cable per phase	(6)	-	3x500 mm <sup>2</sup>	4x500 mm <sup>2</sup>
<b>Short circuit current I<sub>cw</sub> 1 sec.</b>				
Short circuit current I <sub>cw</sub> 1 sec.	(6)	kA	25	25
<p>(1) Standard Rating Conditions for Air to water chillers according to EN14511:2 Outdoor Heat exchanger inlet dry bulb temperature 35°; Indoor heat exchanger inlet water temperature 12°C, outlet water temperature 7°C. Fouling factor = 0</p> <p>(2) Voltage unbalance between phases must be within ± 3%.</p> <p>(3) Maximum running current is based on max compressor absorbed current in its envelope and max fans absorbed current.</p> <p>(4) Based on minimum allowed voltage → Max. current for wire sizing = Max. Running current x 1,1</p> <p>(5) In case of inverter driven compressor, the starting current is zero</p> <p>(6) It may change in case of unit with options or customized unit. Refer to dedicated unit's wiring diagram.</p>				
<p>The data are referred to the unit without additional options.  All data are subject to change without notice. For updated information on project base refer to unit specific wiring diagram and unit's nameplate data.</p>				

EWAD~TZ- SR C + OPT142C – HIGH AMBIENT KIT (OPERATION ABOVE 46°C) BRS FANS								
MODEL	notes		H11	H12	H13	C15	C16	H17
Phases		n	3					
Frequency		Hz	50					
Voltage	(2)	V	400					
Voltage Tolerances min/max		%	-10 / +10					
Nominal Running Current	(1)	A	630,3	673,6	715,5	789,1	857,9	936,5
Max. running current	(3)	A	1015	1050	1064	1294	1320	1442
Max. current for wire sizing	(4)	A	1117	1155	1170	1423	1452	1586
Maximum starting current	(5)	A	0	0	0	0	0	0
Fan starting method	(6)	-	EC Brushless Motor					
Max running current per fan	(6)	A	1,40					
Total fans running current	(6)	A	31,0	31,0	34,0	34,0	36,0	39,0
Compressor starting method			Variable Frequency Drive					
Max. running current Compressor #1	(6)	A	367	388	411	480	521	562
Max. running current Compressor #2	(6)	A	367	388	411	480	521	562
Main switch size	(6)	A	1600	1600	1600	2000	2000	2000
Terminal connection	(6)	-	Bars	Bars	Bars	Bars	Bars	Bars
Cable per phase	(6)	-	2x500 mm <sup>2</sup>	2x500 mm <sup>2</sup>	2x500 mm <sup>2</sup>	3x500 mm <sup>2</sup>	3x500 mm <sup>2</sup>	3x500 mm <sup>2</sup>
Short circuit current Icw 1 sec.	(6)	kA	25	25	25	25	25	25
<p>(1) Standard Rating Conditions for Air to water chillers according to EN14511:2 Outdoor Heat exchanger inlet dry bulb temperature 35°; Indoor heat exchanger inlet water temperature 12°C, outlet water temperature 7°C. Fouling factor = 0</p> <p>(2) Voltage unbalance between phases must be within ± 3%.</p> <p>(3) Maximum running current is based on max compressor absorbed current in its envelope and max fans absorbed current.</p> <p>(4) Based on minimum allowed voltage → Max. current for wire sizing = Max. Running current x 1,1</p> <p>(5) In case of inverter driven compressor, the starting current is zero</p> <p>(6) It may change in case of unit with options or customized unit. Refer to dedicated unit's wiring diagram.</p> <p>The data are referred to the unit without additional options. All data are subject to change without notice. For updated information on project base refer to unit specific wiring diagram and unit's nameplate data.</p>								

EWAD~TZ- SR C + OPT142C – HIGH AMBIENT KIT (OPERATION ABOVE 46°C) BRS FANS				
MODEL	notes		H18	H19
Phases		n	3	
Frequency		Hz	50	
Voltage	(2)	V	400	
Voltage Tolerances min/max		%	-10 / +10	
<b>Nominal Running Current</b>				
Nominal Running Current	(1)	A	1016	1118
<b>Max. running current</b>				
Max. running current	(3)	A	1551	1649
<b>Max. current for wire sizing</b>				
Max. current for wire sizing	(4)	A	1706	1814
<b>Maximum starting current</b>				
Maximum starting current	(5)	A	0	0
<b>Fan starting method</b>				
Fan starting method	(6)	-	EC Brushless Motor	
<b>Max running current per fan</b>				
Max running current per fan	(6)	A	1,40	
<b>Total fans running current</b>				
Total fans running current	(6)	A	42,0	42,0
<b>Compressor starting method</b>				
Compressor starting method			Variable Frequency Drive	
<b>Max. running current Compressor #1</b>				
Max. running current Compressor #1	(6)	A	605	649
<b>Max. running current Compressor #2</b>				
Max. running current Compressor #2	(6)	A	605	649
<b>Main switch size</b>				
Main switch size	(6)	A	2000	2500
<b>Terminal connection</b>				
Terminal connection	(6)	-	Bars	Bars
<b>Cable per phase</b>				
Cable per phase	(6)	-	3x500 mm <sup>2</sup>	4x500 mm <sup>2</sup>
<b>Short circuit current I<sub>cw</sub> 1 sec.</b>				
Short circuit current I <sub>cw</sub> 1 sec.	(6)	kA	25	25
<p>(1) Standard Rating Conditions for Air to water chillers according to EN14511:2 Outdoor Heat exchanger inlet dry bulb temperature 35°; Indoor heat exchanger inlet water temperature 12°C, outlet water temperature 7°C. Fouling factor = 0</p> <p>(2) Voltage unbalance between phases must be within ± 3%.</p> <p>(3) Maximum running current is based on max compressor absorbed current in its envelope and max fans absorbed current.</p> <p>(4) Based on minimum allowed voltage → Max. current for wire sizing = Max. Running current x 1,1</p> <p>(5) In case of inverter driven compressor, the starting current is zero</p> <p>(6) It may change in case of unit with options or customized unit. Refer to dedicated unit's wiring diagram.</p>				
<p>The data are referred to the unit without additional options. All data are subject to change without notice. For updated information on project base refer to unit specific wiring diagram and unit's nameplate data.</p>				



EWAD~TZ- XS C + OPT142C – HIGH AMBIENT KIT (OPERATION ABOVE 46°C) BRS FANS								
MODEL	notes		C11	C12	H12	C14	C15	H16
Phases		n	3					
Frequency		Hz	50					
Voltage	(2)	V	400					
Voltage Tolerances min/max		%	-10 / +10					
<b>Nominal Running Current</b>								
Nominal Running Current	(1)	A	586,8	628,2	668,7	708,8	777,5	844,4
<b>Max. running current</b>								
Max. running current	(3)	A	1021	1028	1062	1205	1246	1333
<b>Max. current for wire sizing</b>								
Max. current for wire sizing	(4)	A	1123	1131	1168	1326	1371	1466
<b>Maximum starting current</b>								
Maximum starting current	(5)	A	0	0	0	0	0	0
<b>Fan starting method</b>								
Fan starting method	(6)	-	EC Brushless Motor					
<b>Max running current per fan</b>								
Max running current per fan	(6)	A	1,40	1,40	1,40	2,22	2,22	2,22
<b>Total fans running current</b>								
Total fans running current	(6)	A	31,0	34,0	36,0	34,0	36,0	39,0
<b>Compressor starting method</b>								
Compressor starting method			Variable Frequency Drive					
<b>Max. running current Compressor #1</b>								
Max. running current Compressor #1	(6)	A	370	367	388	440	480	521
<b>Max. running current Compressor #2</b>								
Max. running current Compressor #2	(6)	A	370	367	388	440	480	521
<b>Main switch size</b>								
Main switch size	(6)	A	1600	1600	1600	1600	1600	2000
<b>Terminal connection</b>								
Terminal connection	(6)	-	Bars	Bars	Bars	Bars	Bars	Bars
<b>Cable per phase</b>								
Cable per phase	(6)	-	2x500 mm <sup>2</sup>	2x500 mm <sup>2</sup>	2x500 mm <sup>2</sup>	2x500 mm <sup>2</sup>	2x500 mm <sup>2</sup>	3x500 mm <sup>2</sup>
<b>Short circuit current I<sub>cs</sub> 1 sec.</b>								
Short circuit current I <sub>cs</sub> 1 sec.	(6)	kA	25	25	25	25	25	25
<p>(1) Standard Rating Conditions for Air to water chillers according to EN14511:2 Outdoor Heat exchanger inlet dry bulb temperature 35°; Indoor heat exchanger inlet water temperature 12°C, outlet water temperature 7°C. Fouling factor = 0</p> <p>(2) Voltage unbalance between phases must be within ± 3%.</p> <p>(3) Maximum running current is based on max compressor absorbed current in its envelope and max fans absorbed current.</p> <p>(4) Based on minimum allowed voltage → Max. current for wire sizing = Max. Running current x 1,1</p> <p>(5) In case of inverter driven compressor, the starting current is zero</p> <p>(6) It may change in case of unit with options or customized unit. Refer to dedicated unit's wiring diagram.</p> <p>The data are referred to the unit without additional options. All data are subject to change without notice. For updated information on project base refer to unit specific wiring diagram and unit's nameplate data.</p>								

EWAD~TZ- XS C + OPT142C – HIGH AMBIENT KIT (OPERATION ABOVE 46°C) BRS FANS			
MODEL	notes		H17
Phases		n	3
Frequency		Hz	50
Voltage	(2)	V	400
Voltage Tolerances min/max		%	-10 / +10
<b>Nominal Running Current</b>			
Nominal Running Current	(1)	A	926,0
<b>Max. running current</b>			
Max. running current	(3)	A	1456
<b>Max. current for wire sizing</b>			
Max. current for wire sizing	(4)	A	1602
<b>Maximum starting current</b>			
Maximum starting current	(5)	A	0
<b>Fan starting method</b>			
Fan starting method	(6)	-	EC Brushless Motor
<b>Max running current per fan</b>			
Max running current per fan	(6)	A	2,22
<b>Total fans running current</b>			
Total fans running current	(6)	A	66,6
<b>Compressor starting method</b>			
Compressor starting method			Variable Frequency Drive
<b>Max. running current Compressor #1</b>			
Max. running current Compressor #1	(6)	A	562
<b>Max. running current Compressor #2</b>			
Max. running current Compressor #2	(6)	A	562
<b>Main switch size</b>			
Main switch size	(6)	A	2000
<b>Terminal connection</b>			
Terminal connection	(6)	-	Bars
<b>Cable per phase</b>			
Cable per phase	(6)	-	3x500 mm <sup>2</sup>
<b>Short circuit current l<sub>cw</sub> 1 sec.</b>			
Short circuit current l <sub>cw</sub> 1 sec.	(6)	kA	25
<p>(1) Standard Rating Conditions for Air to water chillers according to EN14511:2 Outdoor Heat exchanger inlet dry bulb temperature 35°; Indoor heat exchanger inlet water temperature 12°C, outlet water temperature 7°C. Fouling factor = 0</p> <p>(2) Voltage unbalance between phases must be within ± 3%.</p> <p>(3) Maximum running current is based on max compressor absorbed current in its envelope and max fans absorbed current.</p> <p>(4) Based on minimum allowed voltage → Max. current for wire sizing = Max. Running current x 1,1</p> <p>(5) In case of inverter driven compressor, the starting current is zero</p> <p>(6) It may change in case of unit with options or customized unit. Refer to dedicated unit's wiring diagram.</p>			
<p>The data are referred to the unit without additional options.  All data are subject to change without notice. For updated information on project base refer to unit specific wiring diagram and unit's nameplate data.</p>			

EWAD~TZ- XR C + OPT142C – HIGH AMBIENT KIT (OPERATION ABOVE 46°C) BRS FANS								
MODEL	notes		C11	C12	H12	C14	C15	H16
Phases		n	3					
Frequency		Hz	50					
Voltage	(2)	V	400					
Voltage Tolerances min/max		%	-10 / +10					
Nominal Running Current	(1)	A	588,1	629,7	670,1	711,2	779,8	847,0
Max. running current	(3)	A	1021	1028	1062	1205	1246	1333
Max. current for wire sizing	(4)	A	1123	1131	1168	1326	1371	1466
Maximum starting current	(5)	A	0	0	0	0	0	0
Fan starting method	(6)	-	EC Brushless Motor					
Max running current per fan	(6)	A	1,40					
Total fans running current	(6)	A	31,0	34,0	36,0	34,0	36,0	39,0
Compressor starting method			Variable Frequency Drive					
Max. running current Compressor #1	(6)	A	370	367	388	440	480	521
Max. running current Compressor #2	(6)	A	370	367	388	440	480	521
Main switch size	(6)	A	1600	1600	1600	1600	1600	2000
Terminal connection	(6)	-	Bars	Bars	Bars	Bars	Bars	Bars
Cable per phase	(6)	-	2x500 mm <sup>2</sup>	2x500 mm <sup>2</sup>	2x500 mm <sup>2</sup>	2x500 mm <sup>2</sup>	2x500 mm <sup>2</sup>	3x500 mm <sup>2</sup>
Short circuit current I <sub>cw</sub> 1 sec.	(6)	kA	25	25	25	25	25	25
<p>(1) Standard Rating Conditions for Air to water chillers according to EN14511:2 Outdoor Heat exchanger inlet dry bulb temperature 35°; Indoor heat exchanger inlet water temperature 12°C, outlet water temperature 7°C. Fouling factor = 0</p> <p>(2) Voltage unbalance between phases must be within ± 3%.</p> <p>(3) Maximum running current is based on max compressor absorbed current in its envelope and max fans absorbed current.</p> <p>(4) Based on minimum allowed voltage → Max. current for wire sizing = Max. Running current x 1,1</p> <p>(5) In case of inverter driven compressor, the starting current is zero</p> <p>(6) It may change in case of unit with options or customized unit. Refer to dedicated unit's wiring diagram.</p> <p>The data are referred to the unit without additional options. All data are subject to change without notice. For updated information on project base refer to unit specific wiring diagram and unit's nameplate data.</p>								

EWAD~TZ- XR C + OPT142C – HIGH AMBIENT KIT (OPERATION ABOVE 46°C) BRS FANS			
MODEL	notes		H17
Phases		n	3
Frequency		Hz	50
Voltage	(2)	V	400
Voltage Tolerances min/max		%	-10 / +10
<b>Nominal Running Current</b>			
Nominal Running Current	(1)	A	928,6
<b>Max. running current</b>			
Max. running current	(3)	A	1456
<b>Max. current for wire sizing</b>			
Max. current for wire sizing	(4)	A	1602
<b>Maximum starting current</b>			
Maximum starting current	(5)	A	0
<b>Fan starting method</b>			
Fan starting method	(6)	-	EC Brushless Motor
<b>Max running current per fan</b>			
Max running current per fan	(6)	A	1,40
<b>Total fans running current</b>			
Total fans running current	(6)	A	42,0
<b>Compressor starting method</b>			
Compressor starting method			Variable Frequency Drive
<b>Max. running current Compressor #1</b>			
Max. running current Compressor #1	(6)	A	562
<b>Max. running current Compressor #2</b>			
Max. running current Compressor #2	(6)	A	562
<b>Main switch size</b>			
Main switch size	(6)	A	2000
<b>Terminal connection</b>			
Terminal connection	(6)	-	Bars
<b>Cable per phase</b>			
Cable per phase	(6)	-	3x500 mm <sup>2</sup>
<b>Short circuit current Icw 1 sec.</b>			
Short circuit current Icw 1 sec.	(6)	kA	25
<p>(1) Standard Rating Conditions for Air to water chillers according to EN14511:2 Outdoor Heat exchanger inlet dry bulb temperature 35°; Indoor heat exchanger inlet water temperature 12°C, outlet water temperature 7°C. Fouling factor = 0</p> <p>(2) Voltage unbalance between phases must be within ± 3%.</p> <p>(3) Maximum running current is based on max compressor absorbed current in its envelope and max fans absorbed current.</p> <p>(4) Based on minimum allowed voltage → Max. current for wire sizing = Max. Running current x 1,1</p> <p>(5) In case of inverter driven compressor, the starting current is zero</p> <p>(6) It may change in case of unit with options or customized unit. Refer to dedicated unit's wiring diagram.</p>			
<p>The data are referred to the unit without additional options.  All data are subject to change without notice. For updated information on project base refer to unit specific wiring diagram and unit's nameplate data.</p>			

EWAH~TZ- SS C + OPT160C – 100 Pa ESP (BRUSHLESS FANS)								
MODEL	notes		710	770	880	940	990	H10
Phases		n	3					
Frequency		Hz	50					
Voltage	(2)	V	400					
Voltage Tolerances min/max		%	-10 / +10					
Nominal Running Current	(1)	A	404,6	428,8	488,6	516,4	544,4	573,8
Max. running current	(3)	A	674	711	880	893	907	949
Max. current for wire sizing	(4)	A	742	782	967	982	997	1044
Maximum starting current	(5)	A	0	0	0	0	0	0
Fan starting method	(6)	-	EC Brushless Motor					
Max running current per fan	(6)	A	3,70					
Total fans running current	(6)	A	51,8	51,8	59,2	66,6	74,0	81,4
Compressor starting method			Variable Frequency Drive					
Max. running current Compressor #1	(6)	A	246	262	291	308	326	345
Max. running current Compressor #2	(6)	A	246	262	291	308	326	345
Main switch size	(6)	A	800	800	1000	1000	1250	1250
Terminal connection	(6)	-	Cables	Cables	Bars	Bars	Bars	Bars
Cable per phase	(6)	-	2x240 mm <sup>2</sup>	2x240 mm <sup>2</sup>	2x300 mm <sup>2</sup>	2x300 mm <sup>2</sup>	2x400 mm <sup>2</sup>	2x400 mm <sup>2</sup>
Short circuit current Icw 1 sec.	(6)	kA	20	20	25	25	25	25
<p>(1) Standard Rating Conditions for Air to water chillers according to EN14511:2 Outdoor Heat exchanger inlet dry bulb temperature 35°; Indoor heat exchanger inlet water temperature 12°C, outlet water temperature 7°C. Fouling factor = 0</p> <p>(2) Voltage unbalance between phases must be within ± 3%.</p> <p>(3) Maximum running current is based on max compressor absorbed current in its envelope and max fans absorbed current.</p> <p>(4) Based on minimum allowed voltage → Max. current for wire sizing = Max. Running current x 1,1</p> <p>(5) In case of inverter driven compressor, the starting current is zero</p> <p>(6) It may change in case of unit with options or customized unit. Refer to dedicated unit's wiring diagram.</p> <p>The data are referred to the unit without additional options. All data are subject to change without notice. For updated information on project base refer to unit specific wiring diagram and unit's nameplate data.</p>								

EWAH~TZ- SS C + OPT160C – 100 Pa ESP (BRUSHLESS FANS)								
MODEL	notes		C11	C12	C13	C14	C15	C16
Phases		n	3					
Frequency		Hz	50					
Voltage	(2)	V	400					
Voltage Tolerances min/max		%	-10 / +10					
Nominal Running Current	(1)	A	606,4	662,1	711,4	773,1	840,7	925,9
Max. running current	(3)	A	1058	1072	1144	1228	1315	1333
Max. current for wire sizing	(4)	A	1164	1179	1258	1351	1447	1466
Maximum starting current	(5)	A	0	0	0	0	0	0
Fan starting method	(6)	-	EC Brushless Motor					
Max running current per fan	(6)	A	3,70					
Total fans running current	(6)	A	88,8	96,2	88,8	96,2	103,6	111,0
Compressor starting method			Variable Frequency Drive					
Max. running current Compressor #1	(6)	A	367	415	419	451	484	518
Max. running current Compressor #2	(6)	A	367	415	419	451	484	518
Main switch size	(6)	A	1250	1250	1600	1600	1600	1600
Terminal connection	(6)	-	Bars	Bars	Bars	Bars	Bars	Bars
Cable per phase	(6)	-	2x400 mm <sup>2</sup>	2x400 mm <sup>2</sup>	2x500 mm <sup>2</sup>	2x500 mm <sup>2</sup>	2x500 mm <sup>2</sup>	2x500 mm <sup>2</sup>
Short circuit current Icw 1 sec.	(6)	kA	25	25	25	25	25	25
<p>(1) Standard Rating Conditions for Air to water chillers according to EN14511:2 Outdoor Heat exchanger inlet dry bulb temperature 35°; Indoor heat exchanger inlet water temperature 12°C, outlet water temperature 7°C. Fouling factor = 0</p> <p>(2) Voltage unbalance between phases must be within ± 3%.</p> <p>(3) Maximum running current is based on max compressor absorbed current in its envelope and max fans absorbed current.</p> <p>(4) Based on minimum allowed voltage → Max. current for wire sizing = Max. Running current x 1,1</p> <p>(5) In case of inverter driven compressor, the starting current is zero</p> <p>(6) It may change in case of unit with options or customized unit. Refer to dedicated unit's wiring diagram.</p> <p>The data are referred to the unit without additional options. All data are subject to change without notice. For updated information on project base refer to unit specific wiring diagram and unit's nameplate data.</p>								

EWAH~TZ- SL C + OPT160C – 100 Pa ESP (BRUSHLESS FANS)								
MODEL	notes		710	770	880	940	990	H10
Phases		n	3					
Frequency		Hz	50					
Voltage	(2)	V	400					
Voltage Tolerances min/max		%	-10 / +10					
Nominal Running Current	(1)	A	404,6	428,8	488,6	516,4	544,4	573,8
Max. running current	(3)	A	674	711	879	893	907	949
Max. current for wire sizing	(4)	A	741	782	967	982	998	1044
Maximum starting current	(5)	A	0	0	0	0	0	0
Fan starting method	(6)	-	EC Brushless Motor					
Max running current per fan	(6)	A	3,70					
Total fans running current	(6)	A	51,8	51,8	59,2	66,6	74,0	81,4
Compressor starting method			Variable Frequency Drive					
Max. running current Compressor #1	(6)	A	246	262	291	308	326	345
Max. running current Compressor #2	(6)	A	246	262	291	308	326	345
Main switch size	(6)	A	800	800	1000	1000	1250	1250
Terminal connection	(6)	-	Cables	Cables	Bars	Bars	Bars	Bars
Cable per phase	(6)	-	2x240 mm <sup>2</sup>	2x240 mm <sup>2</sup>	2x300 mm <sup>2</sup>	2x300 mm <sup>2</sup>	2x400 mm <sup>2</sup>	2x400 mm <sup>2</sup>
Short circuit current I <sub>cs</sub> 1 sec.	(6)	kA	20	20	25	25	25	25
<p>(1) Standard Rating Conditions for Air to water chillers according to EN14511:2 Outdoor Heat exchanger inlet dry bulb temperature 35°; Indoor heat exchanger inlet water temperature 12°C, outlet water temperature 7°C. Fouling factor = 0</p> <p>(2) Voltage unbalance between phases must be within ± 3%.</p> <p>(3) Maximum running current is based on max compressor absorbed current in its envelope and max fans absorbed current.</p> <p>(4) Based on minimum allowed voltage → Max. current for wire sizing = Max. Running current x 1,1</p> <p>(5) In case of inverter driven compressor, the starting current is zero</p> <p>(6) It may change in case of unit with options or customized unit. Refer to dedicated unit's wiring diagram.</p> <p>The data are referred to the unit without additional options. All data are subject to change without notice. For updated information on project base refer to unit specific wiring diagram and unit's nameplate data.</p>								

EWAH~TZ- SL C + OPT160C – 100 Pa ESP (BRUSHLESS FANS)								
MODEL	notes		C11	C12	C13	C14	C15	C16
Phases		n	3					
Frequency		Hz	50					
Voltage	(2)	V	400					
Voltage Tolerances min/max		%	-10 / +10					
Nominal Running Current	(1)	A	606,4	662,1	711,4	773,1	840,7	925,9
Max. running current	(3)	A	1058	1072	1144	1228	1315	1333
Max. current for wire sizing	(4)	A	1164	1179	1258	1351	1447	1466
Maximum starting current	(5)	A	0	0	0	0	0	0
Fan starting method	(6)	-	EC Brushless Motor					
Max running current per fan	(6)	A	3,70					
Total fans running current	(6)	A	88,8	96,2	88,8	96,2	103,6	111,0
Compressor starting method			Variable Frequency Drive					
Max. running current Compressor #1	(6)	A	367	415	419	451	484	518
Max. running current Compressor #2	(6)	A	367	415	419	451	484	518
Main switch size	(6)	A	1250	1250	1600	1600	1600	1600
Terminal connection	(6)	-	Bars	Bars	Bars	Bars	Bars	Bars
Cable per phase	(6)	-	2x400 mm <sup>2</sup>	2x400 mm <sup>2</sup>	2x500 mm <sup>2</sup>	2x500 mm <sup>2</sup>	2x500 mm <sup>2</sup>	2x500 mm <sup>2</sup>
Short circuit current I <sub>cw</sub> 1 sec.	(6)	kA	25	25	25	25	25	25
<p>(1) Standard Rating Conditions for Air to water chillers according to EN14511:2 Outdoor Heat exchanger inlet dry bulb temperature 35°; Indoor heat exchanger inlet water temperature 12°C, outlet water temperature 7°C. Fouling factor = 0</p> <p>(2) Voltage unbalance between phases must be within ± 3%.</p> <p>(3) Maximum running current is based on max compressor absorbed current in its envelope and max fans absorbed current.</p> <p>(4) Based on minimum allowed voltage → Max. current for wire sizing = Max. Running current x 1,1</p> <p>(5) In case of inverter driven compressor, the starting current is zero</p> <p>(6) It may change in case of unit with options or customized unit. Refer to dedicated unit's wiring diagram.</p> <p>The data are referred to the unit without additional options. All data are subject to change without notice. For updated information on project base refer to unit specific wiring diagram and unit's nameplate data.</p>								



EWAH~TZ- SR C + OPT160C – 100 Pa ESP (BRUSHLESS FANS)								
MODEL	notes		710	770	880	940	990	H10
Phases		n	3					
Frequency		Hz	50					
Voltage	(2)	V	400					
Voltage Tolerances min/max		%	-10 / +10					
<b>Nominal Running Current</b>								
Nominal Running Current	(1)	A	404,4	428,6	488,2	516,2	544,1	573,5
<b>Max. running current</b>								
Max. running current	(3)	A	674	711	880	893	907	949
<b>Max. current for wire sizing</b>								
Max. current for wire sizing	(4)	A	742	782	967	982	997	1044
<b>Maximum starting current</b>								
Maximum starting current	(5)	A	0	0	0	0	0	0
<b>Fan starting method</b>								
Fan starting method	(6)	-	EC Brushless Motor					
<b>Max running current per fan</b>								
Max running current per fan	(6)	A	3,70					
<b>Total fans running current</b>								
Total fans running current	(6)	A	51,8	51,8	59,2	66,6	74,0	81,4
<b>Compressor starting method</b>								
Compressor starting method			Variable Frequency Drive					
<b>Max. running current Compressor #1</b>								
Max. running current Compressor #1	(6)	A	246	262	291	308	326	345
<b>Max. running current Compressor #2</b>								
Max. running current Compressor #2	(6)	A	246	262	291	308	326	345
<b>Main switch size</b>								
Main switch size	(6)	A	800	800	1000	1000	1250	1250
<b>Terminal connection</b>								
Terminal connection	(6)	-	Cables	Cables	Bars	Bars	Bars	Bars
<b>Cable per phase</b>								
Cable per phase	(6)	-	2x240 mm <sup>2</sup>	2x240 mm <sup>2</sup>	2x300 mm <sup>2</sup>	2x300 mm <sup>2</sup>	2x400 mm <sup>2</sup>	2x400 mm <sup>2</sup>
<b>Short circuit current I<sub>cs</sub> 1 sec.</b>								
Short circuit current I <sub>cs</sub> 1 sec.	(6)	kA	20	20	25	25	25	25
<p>(1) Standard Rating Conditions for Air to water chillers according to EN14511:2 Outdoor Heat exchanger inlet dry bulb temperature 35°; Indoor heat exchanger inlet water temperature 12°C, outlet water temperature 7°C. Fouling factor = 0</p> <p>(2) Voltage unbalance between phases must be within ± 3%.</p> <p>(3) Maximum running current is based on max compressor absorbed current in its envelope and max fans absorbed current.</p> <p>(4) Based on minimum allowed voltage → Max. current for wire sizing = Max. Running current x 1,1</p> <p>(5) In case of inverter driven compressor, the starting current is zero</p> <p>(6) It may change in case of unit with options or customized unit. Refer to dedicated unit's wiring diagram.</p> <p>The data are referred to the unit without additional options. All data are subject to change without notice. For updated information on project base refer to unit specific wiring diagram and unit's nameplate data.</p>								

EWAH~TZ- SR C + OPT160C – 100 Pa ESP (BRUSHLESS FANS)								
MODEL	notes		C11	C12	C13	C14	C15	C16
Phases		n	3					
Frequency		Hz	50					
Voltage	(2)	V	400					
Voltage Tolerances min/max		%	-10 / +10					
Nominal Running Current	(1)	A	606,1	661,8	710,9	772,6	840,1	925,3
Max. running current	(3)	A	1058	1072	1144	1228	1315	1333
Max. current for wire sizing	(4)	A	1164	1179	1258	1351	1447	1466
Maximum starting current	(5)	A	0	0	0	0	0	0
Fan starting method	(6)	-	EC Brushless Motor					
Max running current per fan	(6)	A	3,70					
Total fans running current	(6)	A	88,8	96,2	88,8	96,2	103,6	111,0
Compressor starting method			Variable Frequency Drive					
Max. running current Compressor #1	(6)	A	367	415	419	451	484	518
Max. running current Compressor #2	(6)	A	367	415	419	451	484	518
Main switch size	(6)	A	1250	1250	1600	1600	1600	1600
Terminal connection	(6)	-	Bars	Bars	Bars	Bars	Bars	Bars
Cable per phase	(6)	-	2x400 mm <sup>2</sup>	2x400 mm <sup>2</sup>	2x500 mm <sup>2</sup>	2x500 mm <sup>2</sup>	2x500 mm <sup>2</sup>	2x500 mm <sup>2</sup>
Short circuit current Icw 1 sec.	(6)	kA	25	25	25	25	25	25
<p>(1) Standard Rating Conditions for Air to water chillers according to EN14511:2 Outdoor Heat exchanger inlet dry bulb temperature 35°; Indoor heat exchanger inlet water temperature 12°C, outlet water temperature 7°C. Fouling factor = 0</p> <p>(2) Voltage unbalance between phases must be within ± 3%.</p> <p>(3) Maximum running current is based on max compressor absorbed current in its envelope and max fans absorbed current.</p> <p>(4) Based on minimum allowed voltage → Max. current for wire sizing = Max. Running current x 1,1</p> <p>(5) In case of inverter driven compressor, the starting current is zero</p> <p>(6) It may change in case of unit with options or customized unit. Refer to dedicated unit's wiring diagram.</p> <p>The data are referred to the unit without additional options. All data are subject to change without notice. For updated information on project base refer to unit specific wiring diagram and unit's nameplate data.</p>								

EWAH~TZ- XS C + OPT160C – 100 Pa ESP (BRUSHLESS FANS)								
MODEL	notes		670	780	840	950	C10	C11
Phases		n	3					
Frequency		Hz	50					
Voltage	(2)	V	400					
Voltage Tolerances min/max		%	-10 / +10					
Nominal Running Current	(1)	A	364,6	422,8	452,9	512,8	546,3	606,5
Max. running current	(3)	A	711	698	767	914	927	1072
Max. current for wire sizing	(4)	A	782	767	844	1005	1020	1179
Maximum starting current	(5)	A	0	0	0	0	0	0
Fan starting method	(6)	-	EC Brushless Motor					
Max running current per fan	(6)	A	3,70					
Total fans running current	(6)	A	51,8	59,2	66,6	81,4	88,8	96,2
Compressor starting method			Variable Frequency Drive					
Max. running current Compressor #1	(6)	A	236	248	276	291	326	367
Max. running current Compressor #2	(6)	A	236	248	276	291	326	367
Main switch size	(6)	A	800	800	1000	1000	1250	1250
Terminal connection	(6)	-	Cables	Cables	Bars	Bars	Bars	Bars
Cable per phase	(6)	-	2x240 mm <sup>2</sup>	2x240 mm <sup>2</sup>	2x300 mm <sup>2</sup>	2x300 mm <sup>2</sup>	2x400 mm <sup>2</sup>	2x400 mm <sup>2</sup>
Short circuit current I <sub>cs</sub> 1 sec.	(6)	kA	20	20	25	25	25	25
<p>(1) Standard Rating Conditions for Air to water chillers according to EN14511:2 Outdoor Heat exchanger inlet dry bulb temperature 35°; Indoor heat exchanger inlet water temperature 12°C, outlet water temperature 7°C. Fouling factor = 0</p> <p>(2) Voltage unbalance between phases must be within ± 3%.</p> <p>(3) Maximum running current is based on max compressor absorbed current in its envelope and max fans absorbed current.</p> <p>(4) Based on minimum allowed voltage → Max. current for wire sizing = Max. Running current x 1,1</p> <p>(5) In case of inverter driven compressor, the starting current is zero</p> <p>(6) It may change in case of unit with options or customized unit. Refer to dedicated unit's wiring diagram.</p> <p>The data are referred to the unit without additional options. All data are subject to change without notice. For updated information on project base refer to unit specific wiring diagram and unit's nameplate data.</p>								

EWAH~TZ- XS C + OPT160C – 100 Pa ESP (BRUSHLESS FANS)						
MODEL	notes		C12	C13	C14	C15
Phases		n	3			
Frequency		Hz	50			
Voltage	(2)	V	400			
Voltage Tolerances min/max		%	-10 / +10			
Nominal Running Current	(1)	A	650,4	706,8	767,0	836,9
Max. running current	(3)	A	1038	1158	1242	1269
Max. current for wire sizing	(4)	A	1142	1274	1366	1396
Maximum starting current	(5)	A	0	0	0	0
Fan starting method	(6)	-	EC Brushless Motor			
Max running current per fan	(6)	A	3,70			
Total fans running current	(6)	A	88,8	96,2	103,6	111,0
Compressor starting method			Variable Frequency Drive			
Max. running current Compressor #1	(6)	A	388	419	451	484
Max. running current Compressor #2	(6)	A	388	419	451	484
Main switch size	(6)	A	1250	1600	1600	1600
Terminal connection	(6)	-	Bars	Bars	Bars	Bars
Cable per phase	(6)	-	2x400 mm <sup>2</sup>	2x500 mm <sup>2</sup>	2x500 mm <sup>2</sup>	2x500 mm <sup>2</sup>
Short circuit current I <sub>cw</sub> 1 sec.	(6)	kA	25	25	25	25
<p>(1) Standard Rating Conditions for Air to water chillers according to EN14511:2 Outdoor Heat exchanger inlet dry bulb temperature 35°; Indoor heat exchanger inlet water temperature 12°C, outlet water temperature 7°C. Fouling factor = 0</p> <p>(2) Voltage unbalance between phases must be within ± 3%.</p> <p>(3) Maximum running current is based on max compressor absorbed current in its envelope and max fans absorbed current.</p> <p>(4) Based on minimum allowed voltage → Max. current for wire sizing = Max. Running current x 1,1</p> <p>(5) In case of inverter driven compressor, the starting current is zero</p> <p>(6) It may change in case of unit with options or customized unit. Refer to dedicated unit's wiring diagram.</p> <p>The data are referred to the unit without additional options. All data are subject to change without notice. For updated information on project base refer to unit specific wiring diagram and unit's nameplate data.</p>						

EWAH~TZ- XL C + OPT160C – 100 Pa ESP (BRUSHLESS FANS)								
MODEL	notes		670	780	840	950	C10	C11
Phases		n	3					
Frequency		Hz	50					
Voltage	(2)	V	400					
Voltage Tolerances min/max		%	-10 / +10					
Nominal Running Current	(1)	A	364,6	422,8	452,9	512,8	546,3	606,5
Max. running current	(3)	A	711	698	767	914	927	1072
Max. current for wire sizing	(4)	A	782	768	844	1005	1020	1179
Maximum starting current	(5)	A	0	0	0	0	0	0
Fan starting method	(6)	-	EC Brushless Motor					
Max running current per fan	(6)	A	3,70					
Total fans running current	(6)	A	51,8	59,2	66,6	81,4	88,8	96,2
Compressor starting method			Variable Frequency Drive					
Max. running current Compressor #1	(6)	A	236	248	276	291	326	367
Max. running current Compressor #2	(6)	A	236	248	276	291	326	367
Main switch size	(6)	A	800	800	1000	1000	1250	1250
Terminal connection	(6)	-	Cables	Cables	Bars	Bars	Bars	Bars
Cable per phase	(6)	-	2x240 mm <sup>2</sup>	2x240 mm <sup>2</sup>	2x300 mm <sup>2</sup>	2x300 mm <sup>2</sup>	2x400 mm <sup>2</sup>	2x400 mm <sup>2</sup>
Short circuit current Icw 1 sec.	(6)	kA	20	20	25	25	25	25
<p>(1) Standard Rating Conditions for Air to water chillers according to EN14511:2 Outdoor Heat exchanger inlet dry bulb temperature 35°; Indoor heat exchanger inlet water temperature 12°C, outlet water temperature 7°C. Fouling factor = 0</p> <p>(2) Voltage unbalance between phases must be within ± 3%.</p> <p>(3) Maximum running current is based on max compressor absorbed current in its envelope and max fans absorbed current.</p> <p>(4) Based on minimum allowed voltage → Max. current for wire sizing = Max. Running current x 1,1</p> <p>(5) In case of inverter driven compressor, the starting current is zero</p> <p>(6) It may change in case of unit with options or customized unit. Refer to dedicated unit's wiring diagram.</p> <p>The data are referred to the unit without additional options. All data are subject to change without notice. For updated information on project base refer to unit specific wiring diagram and unit's nameplate data.</p>								

EWAH~TZ- XL C + OPT160C – 100 Pa ESP (BRUSHLESS FANS)						
MODEL	notes		C12	C13	C14	C15
Phases		n	3			
Frequency		Hz	50			
Voltage	(2)	V	400			
Voltage Tolerances min/max		%	-10 / +10			
Nominal Running Current	(1)	A	650,4	706,8	767,0	836,9
Max. running current	(3)	A	1038	1158	1242	1269
Max. current for wire sizing	(4)	A	1142	1274	1366	1396
Maximum starting current	(5)	A	0	0	0	0
Fan starting method	(6)	-	EC Brushless Motor			
Max running current per fan	(6)	A	3,70			
Total fans running current	(6)	A	88,8	96,2	103,6	111,0
Compressor starting method			Variable Frequency Drive			
Max. running current Compressor #1	(6)	A	388	419	451	484
Max. running current Compressor #2	(6)	A	388	419	451	484
Main switch size	(6)	A	1250	1600	1600	1600
Terminal connection	(6)	-	Bars	Bars	Bars	Bars
Cable per phase	(6)	-	2x400 mm <sup>2</sup>	2x500 mm <sup>2</sup>	2x500 mm <sup>2</sup>	2x500 mm <sup>2</sup>
Short circuit current I <sub>cw</sub> 1 sec.	(6)	kA	25	25	25	25
<p>(1) Standard Rating Conditions for Air to water chillers according to EN14511:2 Outdoor Heat exchanger inlet dry bulb temperature 35°; Indoor heat exchanger inlet water temperature 12°C, outlet water temperature 7°C. Fouling factor = 0</p> <p>(2) Voltage unbalance between phases must be within ± 3%.</p> <p>(3) Maximum running current is based on max compressor absorbed current in its envelope and max fans absorbed current.</p> <p>(4) Based on minimum allowed voltage → Max. current for wire sizing = Max. Running current x 1,1</p> <p>(5) In case of inverter driven compressor, the starting current is zero</p> <p>(6) It may change in case of unit with options or customized unit. Refer to dedicated unit's wiring diagram.</p> <p>The data are referred to the unit without additional options. All data are subject to change without notice. For updated information on project base refer to unit specific wiring diagram and unit's nameplate data.</p>						

EWAH~TZ- XR C + OPT160C – 100 Pa ESP (BRUSHLESS FANS)								
MODEL	notes		670	780	840	950	C10	C11
Phases		n	3					
Frequency		Hz	50					
Voltage	(2)	V	400					
Voltage Tolerances min/max		%	-10 / +10					
Nominal Running Current	(1)	A	364,4	422,6	452,7	512,5	546,0	606,2
Max. running current	(3)	A	711	698	767	914	927	1072
Max. current for wire sizing	(4)	A	782	767	844	1005	1020	1179
Maximum starting current	(5)	A	0	0	0	0	0	0
Fan starting method	(6)	-	EC Brushless Motor					
Max running current per fan	(6)	A	3,70					
Total fans running current	(6)	A	51,8	59,2	66,6	81,4	88,8	96,2
Compressor starting method			Variable Frequency Drive					
Max. running current Compressor #1	(6)	A	236	248	276	291	326	367
Max. running current Compressor #2	(6)	A	236	248	276	291	326	367
Main switch size	(6)	A	800	800	1000	1000	1250	1250
Terminal connection	(6)	-	Cables	Cables	Bars	Bars	Bars	Bars
Cable per phase	(6)	-	2x240 mm <sup>2</sup>	2x240 mm <sup>2</sup>	2x300 mm <sup>2</sup>	2x300 mm <sup>2</sup>	2x400 mm <sup>2</sup>	2x400 mm <sup>2</sup>
Short circuit current I <sub>cw</sub> 1 sec.	(6)	kA	20	20	25	25	25	25
<p>(1) Standard Rating Conditions for Air to water chillers according to EN14511:2 Outdoor Heat exchanger inlet dry bulb temperature 35°; Indoor heat exchanger inlet water temperature 12°C, outlet water temperature 7°C. Fouling factor = 0</p> <p>(2) Voltage unbalance between phases must be within ± 3%.</p> <p>(3) Maximum running current is based on max compressor absorbed current in its envelope and max fans absorbed current.</p> <p>(4) Based on minimum allowed voltage → Max. current for wire sizing = Max. Running current x 1,1</p> <p>(5) In case of inverter driven compressor, the starting current is zero</p> <p>(6) It may change in case of unit with options or customized unit. Refer to dedicated unit's wiring diagram.</p> <p>The data are referred to the unit without additional options. All data are subject to change without notice. For updated information on project base refer to unit specific wiring diagram and unit's nameplate data.</p>								

EWAH~TZ- XR C + OPT160C – 100 Pa ESP (BRUSHLESS FANS)						
MODEL	notes		C12	C13	C14	C15
Phases		n	3			
Frequency		Hz	50			
Voltage	(2)	V	400			
Voltage Tolerances min/max		%	-10 / +10			
Nominal Running Current	(1)	A	650,0	706,4	766,5	836,4
Max. running current	(3)	A	1038	1158	1242	1269
Max. current for wire sizing	(4)	A	1142	1274	1366	1396
Maximum starting current	(5)	A	0	0	0	0
Fan starting method	(6)	-	EC Brushless Motor			
Max running current per fan	(6)	A	3,70			
Total fans running current	(6)	A	88,8	96,2	103,6	111,0
Compressor starting method			Variable Frequency Drive			
Max. running current Compressor #1	(6)	A	388	419	451	484
Max. running current Compressor #2	(6)	A	388	419	451	484
Main switch size	(6)	A	1250	1600	1600	1600
Terminal connection	(6)	-	Bars	Bars	Bars	Bars
Cable per phase	(6)	-	2x400 mm <sup>2</sup>	2x500 mm <sup>2</sup>	2x500 mm <sup>2</sup>	2x500 mm <sup>2</sup>
Short circuit current I <sub>cw</sub> 1 sec.	(6)	kA	25	25	25	25
<p>(1) Standard Rating Conditions for Air to water chillers according to EN14511:2 Outdoor Heat exchanger inlet dry bulb temperature 35°; Indoor heat exchanger inlet water temperature 12°C, outlet water temperature 7°C. Fouling factor = 0</p> <p>(2) Voltage unbalance between phases must be within ± 3%.</p> <p>(3) Maximum running current is based on max compressor absorbed current in its envelope and max fans absorbed current.</p> <p>(4) Based on minimum allowed voltage → Max. current for wire sizing = Max. Running current x 1,1</p> <p>(5) In case of inverter driven compressor, the starting current is zero</p> <p>(6) It may change in case of unit with options or customized unit. Refer to dedicated unit's wiring diagram.</p> <p>The data are referred to the unit without additional options. All data are subject to change without notice. For updated information on project base refer to unit specific wiring diagram and unit's nameplate data.</p>						



EWAD~TZ- SS C + OPT160C – 100 Pa ESP (BRUSHLESS FANS)								
MODEL	notes		H11	H12	H13	C15	C16	H17
Phases		n	3					
Frequency		Hz	50					
Voltage	(2)	V	400					
Voltage Tolerances min/max		%	-10 / +10					
Nominal Running Current	(1)	A	640,1	684,5	726,1	805,6	875,3	953,6
Max. running current	(3)	A	1015	1050	1064	1294	1320	1442
Max. current for wire sizing	(4)	A	1117	1155	1170	1423	1452	1586
Maximum starting current	(5)	A	0	0	0	0	0	0
Fan starting method	(6)	-	EC Brushless Motor					
Max running current per fan	(6)	A	3,70					
Total fans running current	(6)	A	81,4	81,4	88,8	88,8	96,2	103,6
Compressor starting method			Variable Frequency Drive					
Max. running current Compressor #1	(6)	A	367	388	411	480	521	562
Max. running current Compressor #2	(6)	A	367	388	411	480	521	562
Main switch size	(6)	A	1250	1250	1250	1600	1600	2000
Terminal connection	(6)	-	Bars	Bars	Bars	Bars	Bars	Bars
Cable per phase	(6)	-	2x400 mm <sup>2</sup>	2x400 mm <sup>2</sup>	2x400 mm <sup>2</sup>	2x500 mm <sup>2</sup>	2x500 mm <sup>2</sup>	3x500 mm <sup>2</sup>
Short circuit current Icw 1 sec.	(6)	kA	25	25	25	25	25	25
<p>(1) Standard Rating Conditions for Air to water chillers according to EN14511:2 Outdoor Heat exchanger inlet dry bulb temperature 35°; Indoor heat exchanger inlet water temperature 12°C, outlet water temperature 7°C. Fouling factor = 0</p> <p>(2) Voltage unbalance between phases must be within ± 3%.</p> <p>(3) Maximum running current is based on max compressor absorbed current in its envelope and max fans absorbed current.</p> <p>(4) Based on minimum allowed voltage → Max. current for wire sizing = Max. Running current x 1,1</p> <p>(5) In case of inverter driven compressor, the starting current is zero</p> <p>(6) It may change in case of unit with options or customized unit. Refer to dedicated unit's wiring diagram.</p> <p>The data are referred to the unit without additional options. All data are subject to change without notice. For updated information on project base refer to unit specific wiring diagram and unit's nameplate data.</p>								

EWAD~TZ- SS C + OPT160C – 100 Pa ESP (BRUSHLESS FANS)				
MODEL	notes		H18	H19
Phases		n	3	
Frequency		Hz	50	
Voltage	(2)	V	400	
Voltage Tolerances min/max		%	-10 / +10	
<b>Nominal Running Current</b>				
Nominal Running Current	(1)	A	1034	1138
<b>Max. running current</b>				
Max. running current	(3)	A	1551	1649
<b>Max. current for wire sizing</b>				
Max. current for wire sizing	(4)	A	1706	1814
<b>Maximum starting current</b>				
Maximum starting current	(5)	A	0	0
<b>Fan starting method</b>				
Fan starting method	(6)	-	EC Brushless Motor	
<b>Max running current per fan</b>				
Max running current per fan	(6)	A	3,70	
<b>Total fans running current</b>				
Total fans running current	(6)	A	111	111
<b>Compressor starting method</b>				
Compressor starting method			Variable Frequency Drive	
<b>Max. running current Compressor #1</b>				
Max. running current Compressor #1	(6)	A	605	649
<b>Max. running current Compressor #2</b>				
Max. running current Compressor #2	(6)	A	605	649
<b>Main switch size</b>				
Main switch size	(6)	A	2000	2000
<b>Terminal connection</b>				
Terminal connection	(6)	-	Bars	Bars
<b>Cable per phase</b>				
Cable per phase	(6)	-	3x500 mm <sup>2</sup>	3x500 mm <sup>2</sup>
<b>Short circuit current I<sub>cw</sub> 1 sec.</b>				
Short circuit current I <sub>cw</sub> 1 sec.	(6)	kA	25	25
<p>(1) Standard Rating Conditions for Air to water chillers according to EN14511:2 Outdoor Heat exchanger inlet dry bulb temperature 35°; Indoor heat exchanger inlet water temperature 12°C, outlet water temperature 7°C. Fouling factor = 0</p> <p>(2) Voltage unbalance between phases must be within ± 3%.</p> <p>(3) Maximum running current is based on max compressor absorbed current in its envelope and max fans absorbed current.</p> <p>(4) Based on minimum allowed voltage → Max. current for wire sizing = Max. Running current x 1,1</p> <p>(5) In case of inverter driven compressor, the starting current is zero</p> <p>(6) It may change in case of unit with options or customized unit. Refer to dedicated unit's wiring diagram.</p>				
<p>The data are referred to the unit without additional options.  All data are subject to change without notice. For updated information on project base refer to unit specific wiring diagram and unit's nameplate data.</p>				

EWAD~TZ- SL C + OPT160C – 100 Pa ESP (BRUSHLESS FANS)								
MODEL	notes		H11	H12	H13	C15	C16	H17
Phases		n	3					
Frequency		Hz	50					
Voltage	(2)	V	400					
Voltage Tolerances min/max		%	-10 / +10					
Nominal Running Current	(1)	A	640,1	684,5	726,1	805,6	875,3	953,6
Max. running current	(3)	A	1015	1050	1064	1294	1320	1442
Max. current for wire sizing	(4)	A	1117	1155	1170	1423	1452	1586
Maximum starting current	(5)	A	0	0	0	0	0	0
Fan starting method	(6)	-	EC Brushless Motor					
Max running current per fan	(6)	A	3,70					
Total fans running current	(6)	A	81,4	81,4	88,8	88,8	96,2	103,6
Compressor starting method			Variable Frequency Drive					
Max. running current Compressor #1	(6)	A	367	388	411	480	521	562
Max. running current Compressor #2	(6)	A	367	388	411	480	521	562
Main switch size	(6)	A	1250	1250	1250	1600	1600	2000
Terminal connection	(6)	-	Bars	Bars	Bars	Bars	Bars	Bars
Cable per phase	(6)	-	2x400 mm <sup>2</sup>	2x400 mm <sup>2</sup>	2x400 mm <sup>2</sup>	2x500 mm <sup>2</sup>	2x500 mm <sup>2</sup>	3x500 mm <sup>2</sup>
Short circuit current I <sub>cw</sub> 1 sec.	(6)	kA	25	25	25	25	25	25
<p>(1) Standard Rating Conditions for Air to water chillers according to EN14511:2 Outdoor Heat exchanger inlet dry bulb temperature 35°; Indoor heat exchanger inlet water temperature 12°C, outlet water temperature 7°C. Fouling factor = 0</p> <p>(2) Voltage unbalance between phases must be within ± 3%.</p> <p>(3) Maximum running current is based on max compressor absorbed current in its envelope and max fans absorbed current.</p> <p>(4) Based on minimum allowed voltage → Max. current for wire sizing = Max. Running current x 1,1</p> <p>(5) In case of inverter driven compressor, the starting current is zero</p> <p>(6) It may change in case of unit with options or customized unit. Refer to dedicated unit's wiring diagram.</p> <p>The data are referred to the unit without additional options. All data are subject to change without notice. For updated information on project base refer to unit specific wiring diagram and unit's nameplate data.</p>								

EWAD~TZ- SL C + OPT160C – 100 Pa ESP (BRUSHLESS FANS)				
MODEL	notes		H18	H19
Phases		n	3	
Frequency		Hz	50	
Voltage	(2)	V	400	
Voltage Tolerances min/max		%	-10 / +10	
<b>Nominal Running Current</b>				
Nominal Running Current	(1)	A	1034	1138
<b>Max. running current</b>				
Max. running current	(3)	A	1551	1649
<b>Max. current for wire sizing</b>				
Max. current for wire sizing	(4)	A	1706	1814
<b>Maximum starting current</b>				
Maximum starting current	(5)	A	0	0
<b>Fan starting method</b>				
Fan starting method	(6)	-	EC Brushless Motor	
<b>Max running current per fan</b>				
Max running current per fan	(6)	A	3,70	
<b>Total fans running current</b>				
Total fans running current	(6)	A	111	111
<b>Compressor starting method</b>				
Compressor starting method			Variable Frequency Drive	
<b>Max. running current Compressor #1</b>				
Max. running current Compressor #1	(6)	A	605	649
<b>Max. running current Compressor #2</b>				
Max. running current Compressor #2	(6)	A	605	649
<b>Main switch size</b>				
Main switch size	(6)	A	2000	2000
<b>Terminal connection</b>				
Terminal connection	(6)	-	Bars	Bars
<b>Cable per phase</b>				
Cable per phase	(6)	-	3x500 mm <sup>2</sup>	3x500 mm <sup>2</sup>
<b>Short circuit current I<sub>cw</sub> 1 sec.</b>				
Short circuit current I <sub>cw</sub> 1 sec.	(6)	kA	25	25
<p>(1) Standard Rating Conditions for Air to water chillers according to EN14511:2 Outdoor Heat exchanger inlet dry bulb temperature 35°; Indoor heat exchanger inlet water temperature 12°C, outlet water temperature 7°C. Fouling factor = 0</p> <p>(2) Voltage unbalance between phases must be within ± 3%.</p> <p>(3) Maximum running current is based on max compressor absorbed current in its envelope and max fans absorbed current.</p> <p>(4) Based on minimum allowed voltage → Max. current for wire sizing = Max. Running current x 1,1</p> <p>(5) In case of inverter driven compressor, the starting current is zero</p> <p>(6) It may change in case of unit with options or customized unit. Refer to dedicated unit's wiring diagram.</p>				
<p>The data are referred to the unit without additional options.  All data are subject to change without notice. For updated information on project base refer to unit specific wiring diagram and unit's nameplate data.</p>				

EWAD~TZ- SR C + OPT160B – 100 Pa ESP (INVERTER FANS)								
MODEL	notes		H11	H12	H13	C15	C16	H17
Phases		n	3					
Frequency		Hz	50					
Voltage	(2)	V	400					
Voltage Tolerances min/max		%	-10 / +10					
<b>Nominal Running Current</b>								
Nominal Running Current	(1)	A	663,7	710,0	752,1	841,5	912,8	992,0
<b>Max. running current</b>								
Max. running current	(3)	A	1015	1050	1064	1294	1320	1442
<b>Max. current for wire sizing</b>								
Max. current for wire sizing	(4)	A	1117	1155	1170	1423	1452	1586
<b>Maximum starting current</b>								
Maximum starting current	(5)	A	0	0	0	0	0	0
<b>Fan starting method</b>								
Fan starting method	(6)	-	Inverter driven motor					
<b>Max running current per fan</b>								
Max running current per fan	(6)	A	4					
<b>Total fans running current</b>								
Total fans running current	(6)	A	88	88	96	96	104	112
<b>Compressor starting method</b>								
Compressor starting method			Variable Frequency Drive					
<b>Max. running current Compressor #1</b>								
Max. running current Compressor #1	(6)	A	367	388	411	480	521	562
<b>Max. running current Compressor #2</b>								
Max. running current Compressor #2	(6)	A	367	388	411	480	521	562
<b>Main switch size</b>								
Main switch size	(6)	A	1250	1250	1250	1600	1600	2000
<b>Terminal connection</b>								
Terminal connection	(6)	-	Bars	Bars	Bars	Bars	Bars	Bars
<b>Cable per phase</b>								
Cable per phase	(6)	-	2x400 mm <sup>2</sup>	2x400 mm <sup>2</sup>	2x400 mm <sup>2</sup>	2x500 mm <sup>2</sup>	2x500 mm <sup>2</sup>	3x500 mm <sup>2</sup>
<b>Short circuit current Icw 1 sec.</b>								
Short circuit current Icw 1 sec.	(6)	kA	25	25	25	25	25	25
<p>(1) Standard Rating Conditions for Air to water chillers according to EN14511:2 Outdoor Heat exchanger inlet dry bulb temperature 35°; Indoor heat exchanger inlet water temperature 12°C, outlet water temperature 7°C. Fouling factor = 0</p> <p>(2) Voltage unbalance between phases must be within ± 3%.</p> <p>(3) Maximum running current is based on max compressor absorbed current in its envelope and max fans absorbed current.</p> <p>(4) Based on minimum allowed voltage → Max. current for wire sizing = Max. Running current x 1,1</p> <p>(5) In case of inverter driven compressor, the starting current is zero</p> <p>(6) It may change in case of unit with options or customized unit. Refer to dedicated unit's wiring diagram.</p>								
<p>The data are referred to the unit without additional options.</p> <p>All data are subject to change without notice. For updated information on project base refer to unit specific wiring diagram and unit's nameplate data.</p>								

EWAD~TZ- SR C + OPT160B – 100 Pa ESP (INVERTER FANS)				
MODEL	notes		H18	H19
Phases		n	3	
Frequency		Hz	50	
Voltage	(2)	V	400	
Voltage Tolerances min/max		%	-10 / +10	
<b>Nominal Running Current</b>				
Nominal Running Current	(1)	A	1074	1182
<b>Max. running current</b>				
Max. running current	(3)	A	1551	1649
<b>Max. current for wire sizing</b>				
Max. current for wire sizing	(4)	A	1706	1814
<b>Maximum starting current</b>				
Maximum starting current	(5)	A	0	0
<b>Fan starting method</b>				
Fan starting method	(6)	-	Inverter driven motor	
<b>Max running current per fan</b>				
Max running current per fan	(6)	A	4	
<b>Total fans running current</b>				
Total fans running current	(6)	A	120	120
<b>Compressor starting method</b>				
Compressor starting method			Variable Frequency Drive	
<b>Max. running current Compressor #1</b>				
Max. running current Compressor #1	(6)	A	605	649
<b>Max. running current Compressor #2</b>				
Max. running current Compressor #2	(6)	A	605	649
<b>Main switch size</b>				
Main switch size	(6)	A	2000	2000
<b>Terminal connection</b>				
Terminal connection	(6)	-	Bars	Bars
<b>Cable per phase</b>				
Cable per phase	(6)	-	3x500 mm <sup>2</sup>	3x500 mm <sup>2</sup>
<b>Short circuit current I<sub>cw</sub> 1 sec.</b>				
Short circuit current I <sub>cw</sub> 1 sec.	(6)	kA	25	25
<p>(1) Standard Rating Conditions for Air to water chillers according to EN14511:2 Outdoor Heat exchanger inlet dry bulb temperature 35°; Indoor heat exchanger inlet water temperature 12°C, outlet water temperature 7°C. Fouling factor = 0</p> <p>(2) Voltage unbalance between phases must be within ± 3%.</p> <p>(3) Maximum running current is based on max compressor absorbed current in its envelope and max fans absorbed current.</p> <p>(4) Based on minimum allowed voltage → Max. current for wire sizing = Max. Running current x 1,1</p> <p>(5) In case of inverter driven compressor, the starting current is zero</p> <p>(6) It may change in case of unit with options or customized unit. Refer to dedicated unit's wiring diagram.</p>				
<p>The data are referred to the unit without additional options. All data are subject to change without notice. For updated information on project base refer to unit specific wiring diagram and unit's nameplate data.</p>				

EWAD~TZ- XS C + OPT160C – 100 Pa ESP (BRUSHLESS FANS)								
MODEL	notes		C11	C12	H12	C14	C15	H16
Phases		n	3					
Frequency		Hz	50					
Voltage	(2)	V	400					
Voltage Tolerances min/max		%	-10 / +10					
<b>Nominal Running Current</b>								
Nominal Running Current	(1)	A	597,1	638,3	679	725,2	795,2	862,6
<b>Max. running current</b>								
Max. running current	(3)	A	1021	1028	1062	1205	1246	1333
<b>Max. current for wire sizing</b>								
Max. current for wire sizing	(4)	A	1123	1131	1168	1326	1371	1466
<b>Maximum starting current</b>								
Maximum starting current	(5)	A	0	0	0	0	0	0
<b>Fan starting method</b>								
Fan starting method	(6)	-	EC Brushless Motor					
<b>Max running current per fan</b>								
Max running current per fan	(6)	A	3,70					
<b>Total fans running current</b>								
Total fans running current	(6)	A	81,4	88,8	96,2	88,8	96,2	103,6
<b>Compressor starting method</b>								
Compressor starting method			Variable Frequency Drive					
<b>Max. running current Compressor #1</b>								
Max. running current Compressor #1	(6)	A	370	367	388	440	480	521
<b>Max. running current Compressor #2</b>								
Max. running current Compressor #2	(6)	A	370	367	388	440	480	521
<b>Main switch size</b>								
Main switch size	(6)	A	1250	1250	1250	1600	1600	1600
<b>Terminal connection</b>								
Terminal connection	(6)	-	Bars	Bars	Bars	Bars	Bars	Bars
<b>Cable per phase</b>								
Cable per phase	(6)	-	2x400 mm <sup>2</sup>	2x400 mm <sup>2</sup>	2x400 mm <sup>2</sup>	2x500 mm <sup>2</sup>	2x500 mm <sup>2</sup>	2x500 mm <sup>2</sup>
<b>Short circuit current I<sub>cw</sub> 1 sec.</b>								
Short circuit current I <sub>cw</sub> 1 sec.	(6)	kA	25	25	25	25	25	25
<p>(1) Standard Rating Conditions for Air to water chillers according to EN14511:2 Outdoor Heat exchanger inlet dry bulb temperature 35°; Indoor heat exchanger inlet water temperature 12°C, outlet water temperature 7°C. Fouling factor = 0</p> <p>(2) Voltage unbalance between phases must be within ± 3%.</p> <p>(3) Maximum running current is based on max compressor absorbed current in its envelope and max fans absorbed current.</p> <p>(4) Based on minimum allowed voltage → Max. current for wire sizing = Max. Running current x 1,1</p> <p>(5) In case of inverter driven compressor, the starting current is zero</p> <p>(6) It may change in case of unit with options or customized unit. Refer to dedicated unit's wiring diagram.</p> <p>The data are referred to the unit without additional options. All data are subject to change without notice. For updated information on project base refer to unit specific wiring diagram and unit's nameplate data.</p>								

EWAD~TZ- XS C + OPT160C – 100 Pa ESP (BRUSHLESS FANS)			
MODEL	notes		H17
Phases		n	3
Frequency		Hz	50
Voltage	(2)	V	400
Voltage Tolerances min/max		%	-10 / +10
<b>Nominal Running Current</b>			
Nominal Running Current	(1)	A	944,6
<b>Max. running current</b>			
Max. running current	(3)	A	1456
<b>Max. current for wire sizing</b>			
Max. current for wire sizing	(4)	A	1602
<b>Maximum starting current</b>			
Maximum starting current	(5)	A	0
<b>Fan starting method</b>			
Fan starting method	(6)	-	EC Brushless Motor
<b>Max running current per fan</b>			
Max running current per fan	(6)	A	3,70
<b>Total fans running current</b>			
Total fans running current	(6)	A	111
<b>Compressor starting method</b>			
Compressor starting method			Variable Frequency Drive
<b>Max. running current Compressor #1</b>			
Max. running current Compressor #1	(6)	A	562
<b>Max. running current Compressor #2</b>			
Max. running current Compressor #2	(6)	A	562
<b>Main switch size</b>			
Main switch size	(6)	A	2000
<b>Terminal connection</b>			
Terminal connection	(6)	-	Bars
<b>Cable per phase</b>			
Cable per phase	(6)	-	3x500 mm <sup>2</sup>
<b>Short circuit current l<sub>cw</sub> 1 sec.</b>			
Short circuit current l <sub>cw</sub> 1 sec.	(6)	kA	25
<p>(1) Standard Rating Conditions for Air to water chillers according to EN14511:2 Outdoor Heat exchanger inlet dry bulb temperature 35°; Indoor heat exchanger inlet water temperature 12°C, outlet water temperature 7°C. Fouling factor = 0</p> <p>(2) Voltage unbalance between phases must be within ± 3%.</p> <p>(3) Maximum running current is based on max compressor absorbed current in its envelope and max fans absorbed current.</p> <p>(4) Based on minimum allowed voltage → Max. current for wire sizing = Max. Running current x 1,1</p> <p>(5) In case of inverter driven compressor, the starting current is zero</p> <p>(6) It may change in case of unit with options or customized unit. Refer to dedicated unit's wiring diagram.</p>			
<p>The data are referred to the unit without additional options.  All data are subject to change without notice. For updated information on project base refer to unit specific wiring diagram and unit's nameplate data.</p>			



EWAD~TZ- XR C + OPT160C – 100 Pa ESP (BRUSHLESS FANS)								
MODEL	notes		C11	C12	H12	C14	C15	H16
Phases		n	3					
Frequency		Hz	50					
Voltage	(2)	V	400					
Voltage Tolerances min/max		%	-10 / +10					
Nominal Running Current	(1)	A	597,1	638,3	679	725,2	795,2	862,6
Max. running current	(3)	A	1021	1028	1062	1205	1246	1333
Max. current for wire sizing	(4)	A	1123	1131	1168	1326	1371	1466
Maximum starting current	(5)	A	0	0	0	0	0	0
Fan starting method	(6)	-	EC Brushless Motor					
Max running current per fan	(6)	A	3,70					
Total fans running current	(6)	A	81,4	88,8	96,2	88,8	96,2	103,6
Compressor starting method			Variable Frequency Drive					
Max. running current Compressor #1	(6)	A	370	367	388	440	480	521
Max. running current Compressor #2	(6)	A	370	367	388	440	480	521
Main switch size	(6)	A	1250	1250	1250	1600	1600	1600
Terminal connection	(6)	-	Bars	Bars	Bars	Bars	Bars	Bars
Cable per phase	(6)	-	2x400 mm <sup>2</sup>	2x400 mm <sup>2</sup>	2x400 mm <sup>2</sup>	2x500 mm <sup>2</sup>	2x500 mm <sup>2</sup>	2x500 mm <sup>2</sup>
Short circuit current I <sub>cw</sub> 1 sec.	(6)	kA	25	25	25	25	25	25
<p>(1) Standard Rating Conditions for Air to water chillers according to EN14511:2 Outdoor Heat exchanger inlet dry bulb temperature 35°; Indoor heat exchanger inlet water temperature 12°C, outlet water temperature 7°C. Fouling factor = 0</p> <p>(2) Voltage unbalance between phases must be within ± 3%.</p> <p>(3) Maximum running current is based on max compressor absorbed current in its envelope and max fans absorbed current.</p> <p>(4) Based on minimum allowed voltage → Max. current for wire sizing = Max. Running current x 1,1</p> <p>(5) In case of inverter driven compressor, the starting current is zero</p> <p>(6) It may change in case of unit with options or customized unit. Refer to dedicated unit's wiring diagram.</p> <p>The data are referred to the unit without additional options. All data are subject to change without notice. For updated information on project base refer to unit specific wiring diagram and unit's nameplate data.</p>								

EWAD~TZ- XR C + OPT160C – 100 Pa ESP (BRUSHLESS FANS)			
MODEL	notes		H17
Phases		n	3
Frequency		Hz	50
Voltage	(2)	V	400
Voltage Tolerances min/max		%	-10 / +10
<b>Nominal Running Current</b>			
Nominal Running Current	(1)	A	944,6
<b>Max. running current</b>			
Max. running current	(3)	A	1456
<b>Max. current for wire sizing</b>			
Max. current for wire sizing	(4)	A	1602
<b>Maximum starting current</b>			
Maximum starting current	(5)	A	0
<b>Fan starting method</b>			
Fan starting method	(6)	-	EC Brushless Motor
<b>Max running current per fan</b>			
Max running current per fan	(6)	A	3,70
<b>Total fans running current</b>			
Total fans running current	(6)	A	111
<b>Compressor starting method</b>			
Compressor starting method			Variable Frequency Drive
<b>Max. running current Compressor #1</b>			
Max. running current Compressor #1	(6)	A	562
<b>Max. running current Compressor #2</b>			
Max. running current Compressor #2	(6)	A	562
<b>Main switch size</b>			
Main switch size	(6)	A	2000
<b>Terminal connection</b>			
Terminal connection	(6)	-	Bars
<b>Cable per phase</b>			
Cable per phase	(6)	-	3x500 mm <sup>2</sup>
<b>Short circuit current l<sub>cw</sub> 1 sec.</b>			
Short circuit current l <sub>cw</sub> 1 sec.	(6)	kA	25
<p>(1) Standard Rating Conditions for Air to water chillers according to EN14511:2 Outdoor Heat exchanger inlet dry bulb temperature 35°; Indoor heat exchanger inlet water temperature 12°C, outlet water temperature 7°C. Fouling factor = 0</p> <p>(2) Voltage unbalance between phases must be within ± 3%.</p> <p>(3) Maximum running current is based on max compressor absorbed current in its envelope and max fans absorbed current.</p> <p>(4) Based on minimum allowed voltage → Max. current for wire sizing = Max. Running current x 1,1</p> <p>(5) In case of inverter driven compressor, the starting current is zero</p> <p>(6) It may change in case of unit with options or customized unit. Refer to dedicated unit's wiring diagram.</p> <p>The data are referred to the unit without additional options. All data are subject to change without notice. For updated information on project base refer to unit specific wiring diagram and unit's nameplate data.</p>			

EWAH~TZ- SS C + OPT161B – 200 Pa ESP (BRUSHLESS FANS)								
MODEL	notes		710	770	880	940	990	H10
Phases		n	3					
Frequency		Hz	50					
Voltage	(2)	V	400					
Voltage Tolerances min/max		%	-10 / +10					
Nominal Running Current	(1)	A	423,5	445,7	508,9	540,6	572,9	605,8
Max. running current	(3)	A	674	711	880	893	907	949
Max. current for wire sizing	(4)	A	742	782	967	982	997	1044
Maximum starting current	(5)	A	0	0	0	0	0	0
Fan starting method	(6)	-	EC Brushless Motor					
Max running current per fan	(6)	A	5,50					
Total fans running current	(6)	A	77	77	88	99	110	121
Compressor starting method			Variable Frequency Drive					
Max. running current Compressor #1	(6)	A	246	262	291	308	326	345
Max. running current Compressor #2	(6)	A	246	262	291	308	326	345
Main switch size	(6)	A	800	800	1000	1000	1250	1250
Terminal connection	(6)	-	Cables	Cables	Bars	Bars	Bars	Bars
Cable per phase	(6)	-	2x240 mm <sup>2</sup>	2x240 mm <sup>2</sup>	2x300 mm <sup>2</sup>	2x300 mm <sup>2</sup>	2x400 mm <sup>2</sup>	2x400 mm <sup>2</sup>
Short circuit current I <sub>cw</sub> 1 sec.	(6)	kA	20	20	25	25	25	25
<p>(1) Standard Rating Conditions for Air to water chillers according to EN14511:2 Outdoor Heat exchanger inlet dry bulb temperature 35°; Indoor heat exchanger inlet water temperature 12°C, outlet water temperature 7°C. Fouling factor = 0</p> <p>(2) Voltage unbalance between phases must be within ± 3%.</p> <p>(3) Maximum running current is based on max compressor absorbed current in its envelope and max fans absorbed current.</p> <p>(4) Based on minimum allowed voltage → Max. current for wire sizing = Max. Running current x 1,1</p> <p>(5) In case of inverter driven compressor, the starting current is zero</p> <p>(6) It may change in case of unit with options or customized unit. Refer to dedicated unit's wiring diagram.</p> <p>The data are referred to the unit without additional options. All data are subject to change without notice. For updated information on project base refer to unit specific wiring diagram and unit's nameplate data.</p>								

EWAH~TZ- SS C + OPT161B – 200 Pa ESP (BRUSHLESS FANS)								
MODEL	notes		C11	C12	C13	C14	C15	C16
Phases		n	3					
Frequency		Hz	50					
Voltage	(2)	V	400					
Voltage Tolerances min/max		%	-10 / +10					
Nominal Running Current	(1)	A	642,2	701,0	741,8	806,7	877,6	964,8
Max. running current	(3)	A	1058	1072	1144	1228	1315	1333
Max. current for wire sizing	(4)	A	1164	1179	1258	1351	1447	1466
Maximum starting current	(5)	A	0	0	0	0	0	0
Fan starting method	(6)	-	EC Brushless Motor					
Max running current per fan	(6)	A	5,50					
Total fans running current	(6)	A	132	143	132	143	154	165
Compressor starting method			Variable Frequency Drive					
Max. running current Compressor #1	(6)	A	367	415	419	451	484	518
Max. running current Compressor #2	(6)	A	367	415	419	451	484	518
Main switch size	(6)	A	1250	1250	1600	1600	1600	1600
Terminal connection	(6)	-	Bars	Bars	Bars	Bars	Bars	Bars
Cable per phase	(6)	-	2x400 mm <sup>2</sup>	2x400 mm <sup>2</sup>	2x500 mm <sup>2</sup>	2x500 mm <sup>2</sup>	2x500 mm <sup>2</sup>	2x500 mm <sup>2</sup>
Short circuit current I <sub>cw</sub> 1 sec.	(6)	kA	25	25	25	25	25	25
<p>(1) Standard Rating Conditions for Air to water chillers according to EN14511:2 Outdoor Heat exchanger inlet dry bulb temperature 35°; Indoor heat exchanger inlet water temperature 12°C, outlet water temperature 7°C. Fouling factor = 0</p> <p>(2) Voltage unbalance between phases must be within ± 3%.</p> <p>(3) Maximum running current is based on max compressor absorbed current in its envelope and max fans absorbed current.</p> <p>(4) Based on minimum allowed voltage → Max. current for wire sizing = Max. Running current x 1,1</p> <p>(5) In case of inverter driven compressor, the starting current is zero</p> <p>(6) It may change in case of unit with options or customized unit. Refer to dedicated unit's wiring diagram.</p> <p>The data are referred to the unit without additional options. All data are subject to change without notice. For updated information on project base refer to unit specific wiring diagram and unit's nameplate data.</p>								

EWAH~TZ- SL C + OPT161B – 200 Pa ESP (BRUSHLESS FANS)								
MODEL	notes		710	770	880	940	990	H10
Phases		n	3					
Frequency		Hz	50					
Voltage	(2)	V	400					
Voltage Tolerances min/max		%	-10 / +10					
Nominal Running Current	(1)	A	423,5	445,7	508,9	540,6	572,9	605,8
Max. running current	(3)	A	674	711	879	893	907	949
Max. current for wire sizing	(4)	A	741	782	967	982	998	1044
Maximum starting current	(5)	A	0	0	0	0	0	0
Fan starting method	(6)	-	EC Brushless Motor					
Max running current per fan	(6)	A	5,50					
Total fans running current	(6)	A	77	77	88	99	110	121
Compressor starting method			Variable Frequency Drive					
Max. running current Compressor #1	(6)	A	246	262	291	308	326	345
Max. running current Compressor #2	(6)	A	246	262	291	308	326	345
Main switch size	(6)	A	800	800	1000	1000	1250	1250
Terminal connection	(6)	-	Cables	Cables	Bars	Bars	Bars	Bars
Cable per phase	(6)	-	2x240 mm <sup>2</sup>	2x240 mm <sup>2</sup>	2x300 mm <sup>2</sup>	2x300 mm <sup>2</sup>	2x400 mm <sup>2</sup>	2x400 mm <sup>2</sup>
Short circuit current Icw 1 sec.	(6)	kA	20	20	25	25	25	25
<p>(1) Standard Rating Conditions for Air to water chillers according to EN14511:2 Outdoor Heat exchanger inlet dry bulb temperature 35°; Indoor heat exchanger inlet water temperature 12°C, outlet water temperature 7°C. Fouling factor = 0</p> <p>(2) Voltage unbalance between phases must be within ± 3%.</p> <p>(3) Maximum running current is based on max compressor absorbed current in its envelope and max fans absorbed current.</p> <p>(4) Based on minimum allowed voltage → Max. current for wire sizing = Max. Running current x 1,1</p> <p>(5) In case of inverter driven compressor, the starting current is zero</p> <p>(6) It may change in case of unit with options or customized unit. Refer to dedicated unit's wiring diagram.</p> <p>The data are referred to the unit without additional options. All data are subject to change without notice. For updated information on project base refer to unit specific wiring diagram and unit's nameplate data.</p>								

EWAH~TZ- SL C + OPT161B – 200 Pa ESP (BRUSHLESS FANS)								
MODEL	notes		C11	C12	C13	C14	C15	C16
Phases		n	3					
Frequency		Hz	50					
Voltage	(2)	V	400					
Voltage Tolerances min/max		%	-10 / +10					
Nominal Running Current	(1)	A	642,2	701,0	741,8	806,7	877,6	964,8
Max. running current	(3)	A	1058	1072	1144	1228	1315	1333
Max. current for wire sizing	(4)	A	1164	1179	1258	1351	1447	1466
Maximum starting current	(5)	A	0	0	0	0	0	0
Fan starting method	(6)	-	EC Brushless Motor					
Max running current per fan	(6)	A	5,50					
Total fans running current	(6)	A	132	143	132	143	154	165
Compressor starting method			Variable Frequency Drive					
Max. running current Compressor #1	(6)	A	367	415	419	451	484	518
Max. running current Compressor #2	(6)	A	367	415	419	451	484	518
Main switch size	(6)	A	1250	1250	1600	1600	1600	1600
Terminal connection	(6)	-	Bars	Bars	Bars	Bars	Bars	Bars
Cable per phase	(6)	-	2x400 mm <sup>2</sup>	2x400 mm <sup>2</sup>	2x500 mm <sup>2</sup>	2x500 mm <sup>2</sup>	2x500 mm <sup>2</sup>	2x500 mm <sup>2</sup>
Short circuit current I <sub>cw</sub> 1 sec.	(6)	kA	25	25	25	25	25	25
<p>(1) Standard Rating Conditions for Air to water chillers according to EN14511:2 Outdoor Heat exchanger inlet dry bulb temperature 35°; Indoor heat exchanger inlet water temperature 12°C, outlet water temperature 7°C. Fouling factor = 0</p> <p>(2) Voltage unbalance between phases must be within ± 3%.</p> <p>(3) Maximum running current is based on max compressor absorbed current in its envelope and max fans absorbed current.</p> <p>(4) Based on minimum allowed voltage → Max. current for wire sizing = Max. Running current x 1,1</p> <p>(5) In case of inverter driven compressor, the starting current is zero</p> <p>(6) It may change in case of unit with options or customized unit. Refer to dedicated unit's wiring diagram.</p> <p>The data are referred to the unit without additional options. All data are subject to change without notice. For updated information on project base refer to unit specific wiring diagram and unit's nameplate data.</p>								

EWAH~TZ- SR C + OPT161B – 200 Pa ESP (BRUSHLESS FANS)								
MODEL	notes		710	770	880	940	990	H10
Phases		n	3					
Frequency		Hz	50					
Voltage	(2)	V	400					
Voltage Tolerances min/max		%	-10 / +10					
Nominal Running Current	(1)	A	423,7	446,0	509,3	541,0	573,3	606,1
Max. running current	(3)	A	674	711	880	893	907	949
Max. current for wire sizing	(4)	A	742	782	967	982	997	1044
Maximum starting current	(5)	A	0	0	0	0	0	0
Fan starting method	(6)	-	EC Brushless Motor					
Max running current per fan	(6)	A	5,50					
Total fans running current	(6)	A	77	77	88	99	110	121
Compressor starting method			Variable Frequency Drive					
Max. running current Compressor #1	(6)	A	246	262	291	308	326	345
Max. running current Compressor #2	(6)	A	246	262	291	308	326	345
Main switch size	(6)	A	800	800	1000	1000	1250	1250
Terminal connection	(6)	-	Cables	Cables	Bars	Bars	Bars	Bars
Cable per phase	(6)	-	2x240 mm <sup>2</sup>	2x240 mm <sup>2</sup>	2x300 mm <sup>2</sup>	2x300 mm <sup>2</sup>	2x400 mm <sup>2</sup>	2x400 mm <sup>2</sup>
Short circuit current Icw 1 sec.	(6)	kA	20	20	25	25	25	25
<p>(1) Standard Rating Conditions for Air to water chillers according to EN14511:2 Outdoor Heat exchanger inlet dry bulb temperature 35°; Indoor heat exchanger inlet water temperature 12°C, outlet water temperature 7°C. Fouling factor = 0</p> <p>(2) Voltage unbalance between phases must be within ± 3%.</p> <p>(3) Maximum running current is based on max compressor absorbed current in its envelope and max fans absorbed current.</p> <p>(4) Based on minimum allowed voltage → Max. current for wire sizing = Max. Running current x 1,1</p> <p>(5) In case of inverter driven compressor, the starting current is zero</p> <p>(6) It may change in case of unit with options or customized unit. Refer to dedicated unit's wiring diagram.</p> <p>The data are referred to the unit without additional options. All data are subject to change without notice. For updated information on project base refer to unit specific wiring diagram and unit's nameplate data.</p>								

EWAH~TZ- SR C + OPT161B – 200 Pa ESP (BRUSHLESS FANS)								
MODEL	notes		C11	C12	C13	C14	C15	C16
Phases		n	3					
Frequency		Hz	50					
Voltage	(2)	V	400					
Voltage Tolerances min/max		%	-10 / +10					
<b>Nominal Running Current</b>								
Nominal Running Current	(1)	A	642,6	701,4	742,4	807,2	878,2	965,5
<b>Max. running current</b>								
Max. running current	(3)	A	1058	1072	1144	1228	1315	1333
<b>Max. current for wire sizing</b>								
Max. current for wire sizing	(4)	A	1164	1179	1258	1351	1447	1466
<b>Maximum starting current</b>								
Maximum starting current	(5)	A	0	0	0	0	0	0
<b>Fan starting method</b>								
Fan starting method	(6)	-	EC Brushless Motor					
<b>Max running current per fan</b>								
Max running current per fan	(6)	A	5,50					
<b>Total fans running current</b>								
Total fans running current	(6)	A	132	143	132	143	154	165
<b>Compressor starting method</b>								
Compressor starting method			Variable Frequency Drive					
<b>Max. running current Compressor #1</b>								
Max. running current Compressor #1	(6)	A	367	415	419	451	484	518
<b>Max. running current Compressor #2</b>								
Max. running current Compressor #2	(6)	A	367	415	419	451	484	518
<b>Main switch size</b>								
Main switch size	(6)	A	1250	1250	1600	1600	1600	1600
<b>Terminal connection</b>								
Terminal connection	(6)	-	Bars	Bars	Bars	Bars	Bars	Bars
<b>Cable per phase</b>								
Cable per phase	(6)	-	2x400 mm <sup>2</sup>	2x400 mm <sup>2</sup>	2x500 mm <sup>2</sup>	2x500 mm <sup>2</sup>	2x500 mm <sup>2</sup>	2x500 mm <sup>2</sup>
<b>Short circuit current Icw 1 sec.</b>								
Short circuit current Icw 1 sec.	(6)	kA	25	25	25	25	25	25
<p>(1) Standard Rating Conditions for Air to water chillers according to EN14511:2 Outdoor Heat exchanger inlet dry bulb temperature 35°; Indoor heat exchanger inlet water temperature 12°C, outlet water temperature 7°C. Fouling factor = 0</p> <p>(2) Voltage unbalance between phases must be within ± 3%.</p> <p>(3) Maximum running current is based on max compressor absorbed current in its envelope and max fans absorbed current.</p> <p>(4) Based on minimum allowed voltage → Max. current for wire sizing = Max. Running current x 1,1</p> <p>(5) In case of inverter driven compressor, the starting current is zero</p> <p>(6) It may change in case of unit with options or customized unit. Refer to dedicated unit's wiring diagram.</p> <p>The data are referred to the unit without additional options. All data are subject to change without notice. For updated information on project base refer to unit specific wiring diagram and unit's nameplate data.</p>								



EWAH~TZ- XS C + OPT161B – 200 Pa ESP (BRUSHLESS FANS)								
MODEL	notes		670	780	840	950	C10	C11
Phases		n	3					
Frequency		Hz	50					
Voltage	(2)	V	400					
Voltage Tolerances min/max		%	-10 / +10					
Nominal Running Current	(1)	A	383,6	445,0	478,9	546,4	583,5	646,7
Max. running current	(3)	A	711	698	767	914	927	1072
Max. current for wire sizing	(4)	A	782	767	844	1005	1020	1179
Maximum starting current	(5)	A	0	0	0	0	0	0
Fan starting method	(6)	-	EC Brushless Motor					
Max running current per fan	(6)	A	5,50					
Total fans running current	(6)	A	77	88	99	121	132	143
Compressor starting method			Variable Frequency Drive					
Max. running current Compressor #1	(6)	A	236	248	276	291	326	367
Max. running current Compressor #2	(6)	A	236	248	276	291	326	367
Main switch size	(6)	A	800	800	1000	1000	1250	1250
Terminal connection	(6)	-	Cables	Cables	Bars	Bars	Bars	Bars
Cable per phase	(6)	-	2x240 mm <sup>2</sup>	2x240 mm <sup>2</sup>	2x300 mm <sup>2</sup>	2x300 mm <sup>2</sup>	2x400 mm <sup>2</sup>	2x400 mm <sup>2</sup>
Short circuit current I <sub>cs</sub> 1 sec.	(6)	kA	20	20	25	25	25	25
<p>(1) Standard Rating Conditions for Air to water chillers according to EN14511:2 Outdoor Heat exchanger inlet dry bulb temperature 35°; Indoor heat exchanger inlet water temperature 12°C, outlet water temperature 7°C. Fouling factor = 0</p> <p>(2) Voltage unbalance between phases must be within ± 3%.</p> <p>(3) Maximum running current is based on max compressor absorbed current in its envelope and max fans absorbed current.</p> <p>(4) Based on minimum allowed voltage → Max. current for wire sizing = Max. Running current x 1,1</p> <p>(5) In case of inverter driven compressor, the starting current is zero</p> <p>(6) It may change in case of unit with options or customized unit. Refer to dedicated unit's wiring diagram.</p> <p>The data are referred to the unit without additional options. All data are subject to change without notice. For updated information on project base refer to unit specific wiring diagram and unit's nameplate data.</p>								

EWAH~TZ- XS C + OPT161B – 200 Pa ESP (BRUSHLESS FANS)						
MODEL	notes		C12	C13	C14	C15
Phases		n	3			
Frequency		Hz	50			
Voltage	(2)	V	400			
Voltage Tolerances min/max		%	-10 / +10			
Nominal Running Current	(1)	A	682,2	742,0	805,6	878,5
Max. running current	(3)	A	1038	1158	1242	1269
Max. current for wire sizing	(4)	A	1142	1274	1366	1396
Maximum starting current	(5)	A	0	0	0	0
Fan starting method	(6)	-	EC Brushless Motor			
Max running current per fan	(6)	A	5,50			
Total fans running current	(6)	A	132	143	154	165,0
Compressor starting method			Variable Frequency Drive			
Max. running current Compressor #1	(6)	A	388	419	451	484
Max. running current Compressor #2	(6)	A	388	419	451	484
Main switch size	(6)	A	1250	1600	1600	1600
Terminal connection	(6)	-	Bars	Bars	Bars	Bars
Cable per phase	(6)	-	2x400 mm <sup>2</sup>	2x500 mm <sup>2</sup>	2x500 mm <sup>2</sup>	2x500 mm <sup>2</sup>
Short circuit current I <sub>cw</sub> 1 sec.	(6)	kA	25	25	25	25
<p>(1) Standard Rating Conditions for Air to water chillers according to EN14511:2 Outdoor Heat exchanger inlet dry bulb temperature 35°; Indoor heat exchanger inlet water temperature 12°C, outlet water temperature 7°C. Fouling factor = 0</p> <p>(2) Voltage unbalance between phases must be within ± 3%.</p> <p>(3) Maximum running current is based on max compressor absorbed current in its envelope and max fans absorbed current.</p> <p>(4) Based on minimum allowed voltage → Max. current for wire sizing = Max. Running current x 1,1</p> <p>(5) In case of inverter driven compressor, the starting current is zero</p> <p>(6) It may change in case of unit with options or customized unit. Refer to dedicated unit's wiring diagram.</p> <p>The data are referred to the unit without additional options. All data are subject to change without notice. For updated information on project base refer to unit specific wiring diagram and unit's nameplate data.</p>						

EWAH~TZ- XL C + OPT161B – 200 Pa ESP (BRUSHLESS FANS)								
MODEL	notes		670	780	840	950	C10	C11
Phases		n	3					
Frequency		Hz	50					
Voltage	(2)	V	400					
Voltage Tolerances min/max		%	-10 / +10					
Nominal Running Current	(1)	A	383,6	445,0	478,9	546,4	583,5	646,7
Max. running current	(3)	A	711	698	767	914	927	1072
Max. current for wire sizing	(4)	A	782	767	844	1005	1020	1179
Maximum starting current	(5)	A	0	0	0	0	0	0
Fan starting method	(6)	-	EC Brushless Motor					
Max running current per fan	(6)	A	5,50					
Total fans running current	(6)	A	77	88	99	121	132	143
Compressor starting method			Variable Frequency Drive					
Max. running current Compressor #1	(6)	A	236	248	276	291	326	367
Max. running current Compressor #2	(6)	A	236	248	276	291	326	367
Main switch size	(6)	A	800	800	1000	1000	1250	1250
Terminal connection	(6)	-	Cables	Cables	Bars	Bars	Bars	Bars
Cable per phase	(6)	-	2x240 mm <sup>2</sup>	2x240 mm <sup>2</sup>	2x300 mm <sup>2</sup>	2x300 mm <sup>2</sup>	2x400 mm <sup>2</sup>	2x400 mm <sup>2</sup>
Short circuit current I <sub>cw</sub> 1 sec.	(6)	kA	20	20	25	25	25	25
<p>(1) Standard Rating Conditions for Air to water chillers according to EN14511:2 Outdoor Heat exchanger inlet dry bulb temperature 35°; Indoor heat exchanger inlet water temperature 12°C, outlet water temperature 7°C. Fouling factor = 0</p> <p>(2) Voltage unbalance between phases must be within ± 3%.</p> <p>(3) Maximum running current is based on max compressor absorbed current in its envelope and max fans absorbed current.</p> <p>(4) Based on minimum allowed voltage → Max. current for wire sizing = Max. Running current x 1,1</p> <p>(5) In case of inverter driven compressor, the starting current is zero</p> <p>(6) It may change in case of unit with options or customized unit. Refer to dedicated unit's wiring diagram.</p> <p>The data are referred to the unit without additional options. All data are subject to change without notice. For updated information on project base refer to unit specific wiring diagram and unit's nameplate data.</p>								

EWAH~TZ- XL C + OPT161B – 200 Pa ESP (BRUSHLESS FANS)						
MODEL	notes		C12	C13	C14	C15
Phases		n	3			
Frequency		Hz	50			
Voltage	(2)	V	400			
Voltage Tolerances min/max		%	-10 / +10			
Nominal Running Current	(1)	A	682,2	742,0	805,6	878,5
Max. running current	(3)	A	1038	1158	1242	1269
Max. current for wire sizing	(4)	A	1142	1274	1366	1396
Maximum starting current	(5)	A	0	0	0	0
Fan starting method	(6)	-	EC Brushless Motor			
Max running current per fan	(6)	A	5,50			
Total fans running current	(6)	A	132	143	154	165
Compressor starting method			Variable Frequency Drive			
Max. running current Compressor #1	(6)	A	388	419	451	484
Max. running current Compressor #2	(6)	A	388	419	451	484
Main switch size	(6)	A	1250	1600	1600	1600
Terminal connection	(6)	-	Bars	Bars	Bars	Bars
Cable per phase	(6)	-	2x400 mm <sup>2</sup>	2x500 mm <sup>2</sup>	2x500 mm <sup>2</sup>	2x500 mm <sup>2</sup>
Short circuit current Icw 1 sec.	(6)	kA	25	25	25	25
<p>(1) Standard Rating Conditions for Air to water chillers according to EN14511:2 Outdoor Heat exchanger inlet dry bulb temperature 35°; Indoor heat exchanger inlet water temperature 12°C, outlet water temperature 7°C. Fouling factor = 0</p> <p>(2) Voltage unbalance between phases must be within ± 3%.</p> <p>(3) Maximum running current is based on max compressor absorbed current in its envelope and max fans absorbed current.</p> <p>(4) Based on minimum allowed voltage → Max. current for wire sizing = Max. Running current x 1,1</p> <p>(5) In case of inverter driven compressor, the starting current is zero</p> <p>(6) It may change in case of unit with options or customized unit. Refer to dedicated unit's wiring diagram.</p> <p>The data are referred to the unit without additional options. All data are subject to change without notice. For updated information on project base refer to unit specific wiring diagram and unit's nameplate data.</p>						

EWAH~TZ- XR C + OPT161B – 200 Pa ESP (BRUSHLESS FANS)								
MODEL	notes		670	780	840	950	C10	C11
Phases		n	3					
Frequency		Hz	50					
Voltage	(2)	V	400					
Voltage Tolerances min/max		%	-10 / +10					
Nominal Running Current	(1)	A	383,9	445,3	479,2	546,7	583,8	647,0
Max. running current	(3)	A	711	698	767	914	927	1072
Max. current for wire sizing	(4)	A	782	767	844	1005	1020	1179
Maximum starting current	(5)	A	0	0	0	0	0	0
Fan starting method	(6)	-	EC Brushless Motor					
Max running current per fan	(6)	A	5,50					
Total fans running current	(6)	A	77	88	99	121	132	143
Compressor starting method			Variable Frequency Drive					
Max. running current Compressor #1	(6)	A	236	248	276	291	326	367
Max. running current Compressor #2	(6)	A	236	248	276	291	326	367
Main switch size	(6)	A	800	800	1000	1000	1250	1250
Terminal connection	(6)	-	Cables	Cables	Bars	Bars	Bars	Bars
Cable per phase	(6)	-	2x240 mm <sup>2</sup>	2x240 mm <sup>2</sup>	2x300 mm <sup>2</sup>	2x300 mm <sup>2</sup>	2x400 mm <sup>2</sup>	2x400 mm <sup>2</sup>
Short circuit current Icw 1 sec.	(6)	kA	20	20	25	25	25	25
<p>(1) Standard Rating Conditions for Air to water chillers according to EN14511:2 Outdoor Heat exchanger inlet dry bulb temperature 35°; Indoor heat exchanger inlet water temperature 12°C, outlet water temperature 7°C. Fouling factor = 0</p> <p>(2) Voltage unbalance between phases must be within ± 3%.</p> <p>(3) Maximum running current is based on max compressor absorbed current in its envelope and max fans absorbed current.</p> <p>(4) Based on minimum allowed voltage → Max. current for wire sizing = Max. Running current x 1,1</p> <p>(5) In case of inverter driven compressor, the starting current is zero</p> <p>(6) It may change in case of unit with options or customized unit. Refer to dedicated unit's wiring diagram.</p> <p>The data are referred to the unit without additional options. All data are subject to change without notice. For updated information on project base refer to unit specific wiring diagram and unit's nameplate data.</p>								

EWAH~TZ- XR C + OPT161B – 200 Pa ESP (BRUSHLESS FANS)						
MODEL	notes		C12	C13	C14	C15
Phases		n	3			
Frequency		Hz	50			
Voltage	(2)	V	400			
Voltage Tolerances min/max		%	-10 / +10			
Nominal Running Current	(1)	A	682,7	742,5	806,2	879,1
Max. running current	(3)	A	1038	1158	1242	1269
Max. current for wire sizing	(4)	A	1142	1274	1366	1396
Maximum starting current	(5)	A	0	0	0	0
Fan starting method	(6)	-	EC Brushless Motor			
Max running current per fan	(6)	A	5,50			
Total fans running current	(6)	A	132	143	154	165
Compressor starting method			Variable Frequency Drive			
Max. running current Compressor #1	(6)	A	388	419	451	484
Max. running current Compressor #2	(6)	A	388	419	451	484
Main switch size	(6)	A	1250	1600	1600	1600
Terminal connection	(6)	-	Bars	Bars	Bars	Bars
Cable per phase	(6)	-	2x400 mm <sup>2</sup>	2x500 mm <sup>2</sup>	2x500 mm <sup>2</sup>	2x500 mm <sup>2</sup>
Short circuit current I <sub>cw</sub> 1 sec.	(6)	kA	25	25	25	25
<p>(1) Standard Rating Conditions for Air to water chillers according to EN14511:2 Outdoor Heat exchanger inlet dry bulb temperature 35°; Indoor heat exchanger inlet water temperature 12°C, outlet water temperature 7°C. Fouling factor = 0</p> <p>(2) Voltage unbalance between phases must be within ± 3%.</p> <p>(3) Maximum running current is based on max compressor absorbed current in its envelope and max fans absorbed current.</p> <p>(4) Based on minimum allowed voltage → Max. current for wire sizing = Max. Running current x 1,1</p> <p>(5) In case of inverter driven compressor, the starting current is zero</p> <p>(6) It may change in case of unit with options or customized unit. Refer to dedicated unit's wiring diagram.</p> <p>The data are referred to the unit without additional options. All data are subject to change without notice. For updated information on project base refer to unit specific wiring diagram and unit's nameplate data.</p>						

EWAD~TZ- SS C + OPT161B – 200 Pa ESP (BRUSHLESS FANS)								
MODEL	notes		H11	H12	H13	C15	C16	H17
Phases		n	3					
Frequency		Hz	50					
Voltage	(2)	V	400					
Voltage Tolerances min/max		%	-10 / +10					
Nominal Running Current	(1)	A	670,6	713,8	759,1	832,1	905,1	987,1
Max. running current	(3)	A	1015	1050	1064	1294	1320	1442
Max. current for wire sizing	(4)	A	1117	1155	1170	1423	1452	1586
Maximum starting current	(5)	A	0	0	0	0	0	0
Fan starting method	(6)	-	EC Brushless Motor					
Max running current per fan	(6)	A	5,50					
Total fans running current	(6)	A	121	121	132	132	143	154
Compressor starting method			Variable Frequency Drive					
Max. running current Compressor #1	(6)	A	367	388	411	480	521	562
Max. running current Compressor #2	(6)	A	367	388	411	480	521	562
Main switch size	(6)	A	1250	1250	1250	1600	1600	2000
Terminal connection	(6)	-	Bars	Bars	Bars	Bars	Bars	Bars
Cable per phase	(6)	-	2x400 mm <sup>2</sup>	2x400 mm <sup>2</sup>	2x400 mm <sup>2</sup>	2x500 mm <sup>2</sup>	2x500 mm <sup>2</sup>	3x500 mm <sup>2</sup>
Short circuit current I <sub>cw</sub> 1 sec.	(6)	kA	25	25	25	25	25	25
<p>(1) Standard Rating Conditions for Air to water chillers according to EN14511:2 Outdoor Heat exchanger inlet dry bulb temperature 35°; Indoor heat exchanger inlet water temperature 12°C, outlet water temperature 7°C. Fouling factor = 0</p> <p>(2) Voltage unbalance between phases must be within ± 3%.</p> <p>(3) Maximum running current is based on max compressor absorbed current in its envelope and max fans absorbed current.</p> <p>(4) Based on minimum allowed voltage → Max. current for wire sizing = Max. Running current x 1,1</p> <p>(5) In case of inverter driven compressor, the starting current is zero</p> <p>(6) It may change in case of unit with options or customized unit. Refer to dedicated unit's wiring diagram.</p> <p>The data are referred to the unit without additional options. All data are subject to change without notice. For updated information on project base refer to unit specific wiring diagram and unit's nameplate data.</p>								

EWAD~TZ- SS C + OPT161B – 200 Pa ESP (BRUSHLESS FANS)				
MODEL	notes		H18	H19
Phases		n	3	
Frequency		Hz	50	
Voltage	(2)	V	400	
Voltage Tolerances min/max		%	-10 / +10	
<b>Nominal Running Current</b>				
Nominal Running Current	(1)	A	1071	1172
<b>Max. running current</b>				
Max. running current	(3)	A	1551	1649
<b>Max. current for wire sizing</b>				
Max. current for wire sizing	(4)	A	1706	1814
<b>Maximum starting current</b>				
Maximum starting current	(5)	A	0	0
<b>Fan starting method</b>				
Fan starting method	(6)	-	EC Brushless Motor	
<b>Max running current per fan</b>				
Max running current per fan	(6)	A	5,50	
<b>Total fans running current</b>				
Total fans running current	(6)	A	165	165
<b>Compressor starting method</b>				
Compressor starting method			Variable Frequency Drive	
<b>Max. running current Compressor #1</b>				
Max. running current Compressor #1	(6)	A	605	649
<b>Max. running current Compressor #2</b>				
Max. running current Compressor #2	(6)	A	605	649
<b>Main switch size</b>				
Main switch size	(6)	A	2000	2000
<b>Terminal connection</b>				
Terminal connection	(6)	-	Bars	Bars
<b>Cable per phase</b>				
Cable per phase	(6)	-	3x500 mm <sup>2</sup>	3x500 mm <sup>2</sup>
<b>Short circuit current I<sub>cw</sub> 1 sec.</b>				
Short circuit current I <sub>cw</sub> 1 sec.	(6)	kA	25	25
<p>(1) Standard Rating Conditions for Air to water chillers according to EN14511:2 Outdoor Heat exchanger inlet dry bulb temperature 35°; Indoor heat exchanger inlet water temperature 12°C, outlet water temperature 7°C. Fouling factor = 0</p> <p>(2) Voltage unbalance between phases must be within ± 3%.</p> <p>(3) Maximum running current is based on max compressor absorbed current in its envelope and max fans absorbed current.</p> <p>(4) Based on minimum allowed voltage → Max. current for wire sizing = Max. Running current x 1,1</p> <p>(5) In case of inverter driven compressor, the starting current is zero</p> <p>(6) It may change in case of unit with options or customized unit. Refer to dedicated unit's wiring diagram.</p>				
<p>The data are referred to the unit without additional options.  All data are subject to change without notice. For updated information on project base refer to unit specific wiring diagram and unit's nameplate data.</p>				



EWAD~TZ- SL C + OPT161B – 200 Pa ESP (BRUSHLESS FANS)								
MODEL	notes		H11	H12	H13	C15	C16	H17
Phases		n	3					
Frequency		Hz	50					
Voltage	(2)	V	400					
Voltage Tolerances min/max		%	-10 / +10					
Nominal Running Current	(1)	A	670,6	713,8	759,1	832,1	905,1	987,1
Max. running current	(3)	A	1015	1050	1064	1294	1320	1442
Max. current for wire sizing	(4)	A	1117	1155	1170	1423	1452	1586
Maximum starting current	(5)	A	0	0	0	0	0	0
Fan starting method	(6)	-	EC Brushless Motor					
Max running current per fan	(6)	A	5,50					
Total fans running current	(6)	A	121	121	132	132	143	154
Compressor starting method			Variable Frequency Drive					
Max. running current Compressor #1	(6)	A	367	388	411	480	521	562
Max. running current Compressor #2	(6)	A	367	388	411	480	521	562
Main switch size	(6)	A	1250	1250	1250	1600	1600	2000
Terminal connection	(6)	-	Bars	Bars	Bars	Bars	Bars	Bars
Cable per phase	(6)	-	2x400 mm <sup>2</sup>	2x400 mm <sup>2</sup>	2x400 mm <sup>2</sup>	2x500 mm <sup>2</sup>	2x500 mm <sup>2</sup>	3x500 mm <sup>2</sup>
Short circuit current I <sub>cw</sub> 1 sec.	(6)	kA	25	25	25	25	25	25
<p>(1) Standard Rating Conditions for Air to water chillers according to EN14511:2 Outdoor Heat exchanger inlet dry bulb temperature 35°; Indoor heat exchanger inlet water temperature 12°C, outlet water temperature 7°C. Fouling factor = 0</p> <p>(2) Voltage unbalance between phases must be within ± 3%.</p> <p>(3) Maximum running current is based on max compressor absorbed current in its envelope and max fans absorbed current.</p> <p>(4) Based on minimum allowed voltage → Max. current for wire sizing = Max. Running current x 1,1</p> <p>(5) In case of inverter driven compressor, the starting current is zero</p> <p>(6) It may change in case of unit with options or customized unit. Refer to dedicated unit's wiring diagram.</p> <p>The data are referred to the unit without additional options. All data are subject to change without notice. For updated information on project base refer to unit specific wiring diagram and unit's nameplate data.</p>								

<b>EWAD~TZ- SL C + OPT161B – 200 Pa ESP (BRUSHLESS FANS)</b>				
<b>MODEL</b>	<b>notes</b>		<b>H18</b>	<b>H19</b>
Phases		n	3	
Frequency		Hz	50	
Voltage	(2)	V	400	
Voltage Tolerances min/max		%	-10 / +10	
<b>Nominal Running Current</b>				
Nominal Running Current	(1)	A	1071	1172
<b>Max. running current</b>				
Max. running current	(3)	A	1551	1649
<b>Max. current for wire sizing</b>				
Max. current for wire sizing	(4)	A	1706	1814
<b>Maximum starting current</b>				
Maximum starting current	(5)	A	0	0
<b>Fan starting method</b>				
Fan starting method	(6)	-	EC Brushless Motor	
<b>Max running current per fan</b>				
Max running current per fan	(6)	A	5,50	
<b>Total fans running current</b>				
Total fans running current	(6)	A	165	165
<b>Compressor starting method</b>				
Compressor starting method			Variable Frequency Drive	
<b>Max. running current Compressor #1</b>				
Max. running current Compressor #1	(6)	A	605	649
<b>Max. running current Compressor #2</b>				
Max. running current Compressor #2	(6)	A	605	649
<b>Main switch size</b>				
Main switch size	(6)	A	2000	2000
<b>Terminal connection</b>				
Terminal connection	(6)	-	Bars	Bars
<b>Cable per phase</b>				
Cable per phase	(6)	-	3x500 mm <sup>2</sup>	3x500 mm <sup>2</sup>
<b>Short circuit current I<sub>cw</sub> 1 sec.</b>				
Short circuit current I <sub>cw</sub> 1 sec.	(6)	kA	25	25
<p>(1) Standard Rating Conditions for Air to water chillers according to EN14511:2 Outdoor Heat exchanger inlet dry bulb temperature 35°; Indoor heat exchanger inlet water temperature 12°C, outlet water temperature 7°C. Fouling factor = 0</p> <p>(2) Voltage unbalance between phases must be within ± 3%.</p> <p>(3) Maximum running current is based on max compressor absorbed current in its envelope and max fans absorbed current.</p> <p>(4) Based on minimum allowed voltage → Max. current for wire sizing = Max. Running current x 1,1</p> <p>(5) In case of inverter driven compressor, the starting current is zero</p> <p>(6) It may change in case of unit with options or customized unit. Refer to dedicated unit's wiring diagram.</p>				
<p>The data are referred to the unit without additional options.                      All data are subject to change without notice. For updated information on project base refer to unit specific wiring diagram and unit's nameplate data.</p>				

EWAD~TZ- SR C + OPT161B – 200 Pa ESP (BRUSHLESS FANS)								
MODEL	notes		H11	H12	H13	C15	C16	H17
Phases		n	3					
Frequency		Hz	50					
Voltage	(2)	V	400					
Voltage Tolerances min/max		%	-10 / +10					
Nominal Running Current	(1)	A	663,8	710,1	752,2	841,6	912,9	992,1
Max. running current	(3)	A	1015	1050	1064	1294	1320	1442
Max. current for wire sizing	(4)	A	1117	1155	1170	1423	1452	1586
Maximum starting current	(5)	A	0	0	0	0	0	0
Fan starting method	(6)	-	EC Brushless Motor					
Max running current per fan	(6)	A	5,50					
Total fans running current	(6)	A	121	121	132	132	143	154
Compressor starting method			Variable Frequency Drive					
Max. running current Compressor #1	(6)	A	367	388	411	480	521	562
Max. running current Compressor #2	(6)	A	367	388	411	480	521	562
Main switch size	(6)	A	1250	1250	1250	1600	1600	2000
Terminal connection	(6)	-	Bars	Bars	Bars	Bars	Bars	Bars
Cable per phase	(6)	-	2x400 mm <sup>2</sup>	2x400 mm <sup>2</sup>	2x400 mm <sup>2</sup>	2x500 mm <sup>2</sup>	2x500 mm <sup>2</sup>	3x500 mm <sup>2</sup>
Short circuit current I <sub>cw</sub> 1 sec.	(6)	kA	25	25	25	25	25	25
<p>(1) Standard Rating Conditions for Air to water chillers according to EN14511:2 Outdoor Heat exchanger inlet dry bulb temperature 35°; Indoor heat exchanger inlet water temperature 12°C, outlet water temperature 7°C. Fouling factor = 0</p> <p>(2) Voltage unbalance between phases must be within ± 3%.</p> <p>(3) Maximum running current is based on max compressor absorbed current in its envelope and max fans absorbed current.</p> <p>(4) Based on minimum allowed voltage → Max. current for wire sizing = Max. Running current x 1,1</p> <p>(5) In case of inverter driven compressor, the starting current is zero</p> <p>(6) It may change in case of unit with options or customized unit. Refer to dedicated unit's wiring diagram.</p> <p>The data are referred to the unit without additional options. All data are subject to change without notice. For updated information on project base refer to unit specific wiring diagram and unit's nameplate data.</p>								

EWAD~TZ- SR C + OPT161B – 200 Pa ESP (BRUSHLESS FANS)				
MODEL	notes		H18	H19
Phases		n	3	
Frequency		Hz	50	
Voltage	(2)	V	400	
Voltage Tolerances min/max		%	-10 / +10	
<b>Nominal Running Current</b>				
Nominal Running Current	(1)	A	1074	1182
<b>Max. running current</b>				
Max. running current	(3)	A	1551	1649
<b>Max. current for wire sizing</b>				
Max. current for wire sizing	(4)	A	1706	1814
<b>Maximum starting current</b>				
Maximum starting current	(5)	A	0	0
<b>Fan starting method</b>				
Fan starting method	(6)	-	EC Brushless Motor	
<b>Max running current per fan</b>				
Max running current per fan	(6)	A	5,50	
<b>Total fans running current</b>				
Total fans running current	(6)	A	165	165
<b>Compressor starting method</b>				
Compressor starting method			Variable Frequency Drive	
<b>Max. running current Compressor #1</b>				
Max. running current Compressor #1	(6)	A	605	649
<b>Max. running current Compressor #2</b>				
Max. running current Compressor #2	(6)	A	605	649
<b>Main switch size</b>				
Main switch size	(6)	A	2000	2000
<b>Terminal connection</b>				
Terminal connection	(6)	-	Bars	Bars
<b>Cable per phase</b>				
Cable per phase	(6)	-	3x500 mm <sup>2</sup>	3x500 mm <sup>2</sup>
<b>Short circuit current I<sub>cw</sub> 1 sec.</b>				
Short circuit current I <sub>cw</sub> 1 sec.	(6)	kA	25	25
<p>(1) Standard Rating Conditions for Air to water chillers according to EN14511:2 Outdoor Heat exchanger inlet dry bulb temperature 35°; Indoor heat exchanger inlet water temperature 12°C, outlet water temperature 7°C. Fouling factor = 0</p> <p>(2) Voltage unbalance between phases must be within ± 3%.</p> <p>(3) Maximum running current is based on max compressor absorbed current in its envelope and max fans absorbed current.</p> <p>(4) Based on minimum allowed voltage → Max. current for wire sizing = Max. Running current x 1,1</p> <p>(5) In case of inverter driven compressor, the starting current is zero</p> <p>(6) It may change in case of unit with options or customized unit. Refer to dedicated unit's wiring diagram.</p>				
<p>The data are referred to the unit without additional options.  All data are subject to change without notice. For updated information on project base refer to unit specific wiring diagram and unit's nameplate data.</p>				

EWAD~TZ- XS C + OPT161B – 200 Pa ESP (BRUSHLESS FANS)								
MODEL	notes		C11	C12	H12	C14	C15	H16
Phases		n	3					
Frequency		Hz	50					
Voltage	(2)	V	400					
Voltage Tolerances min/max		%	-10 / +10					
Nominal Running Current	(1)	A	628,4	673,5	717,7	754,6	827,1	897,7
Max. running current	(3)	A	1021	1028	1062	1205	1246	1333
Max. current for wire sizing	(4)	A	1123	1131	1168	1326	1371	1466
Maximum starting current	(5)	A	0	0	0	0	0	0
Fan starting method	(6)	-	EC Brushless Motor					
Max running current per fan	(6)	A	5,50					
Total fans running current	(6)	A	121	132	143	132	143	154
Compressor starting method			Variable Frequency Drive					
Max. running current Compressor #1	(6)	A	370	367	388	440	480	521
Max. running current Compressor #2	(6)	A	370	367	388	440	480	521
Main switch size	(6)	A	1250	1250	1250	1600	1600	1600
Terminal connection	(6)	-	Bars	Bars	Bars	Bars	Bars	Bars
Cable per phase	(6)	-	2x400 mm <sup>2</sup>	2x400 mm <sup>2</sup>	2x400 mm <sup>2</sup>	2x500 mm <sup>2</sup>	2x500 mm <sup>2</sup>	2x500 mm <sup>2</sup>
Short circuit current I <sub>cw</sub> 1 sec.	(6)	kA	25	25	25	25	25	25
<p>(1) Standard Rating Conditions for Air to water chillers according to EN14511:2 Outdoor Heat exchanger inlet dry bulb temperature 35°; Indoor heat exchanger inlet water temperature 12°C, outlet water temperature 7°C. Fouling factor = 0</p> <p>(2) Voltage unbalance between phases must be within ± 3%.</p> <p>(3) Maximum running current is based on max compressor absorbed current in its envelope and max fans absorbed current.</p> <p>(4) Based on minimum allowed voltage → Max. current for wire sizing = Max. Running current x 1,1</p> <p>(5) In case of inverter driven compressor, the starting current is zero</p> <p>(6) It may change in case of unit with options or customized unit. Refer to dedicated unit's wiring diagram.</p> <p>The data are referred to the unit without additional options. All data are subject to change without notice. For updated information on project base refer to unit specific wiring diagram and unit's nameplate data.</p>								

EWAD~TZ- XS C + OPT161B – 200 Pa ESP (BRUSHLESS FANS)			
MODEL	notes		H17
Phases		n	3
Frequency		Hz	50
Voltage	(2)	V	400
Voltage Tolerances min/max		%	-10 / +10
<b>Nominal Running Current</b>			
Nominal Running Current	(1)	A	983,1
<b>Max. running current</b>			
Max. running current	(3)	A	1456
<b>Max. current for wire sizing</b>			
Max. current for wire sizing	(4)	A	1602
<b>Maximum starting current</b>			
Maximum starting current	(5)	A	0
<b>Fan starting method</b>			
Fan starting method	(6)	-	EC Brushless Motor
<b>Max running current per fan</b>			
Max running current per fan	(6)	A	5,50
<b>Total fans running current</b>			
Total fans running current	(6)	A	165
<b>Compressor starting method</b>			
Compressor starting method			Variable Frequency Drive
<b>Max. running current Compressor #1</b>			
Max. running current Compressor #1	(6)	A	562
<b>Max. running current Compressor #2</b>			
Max. running current Compressor #2	(6)	A	562
<b>Main switch size</b>			
Main switch size	(6)	A	2000
<b>Terminal connection</b>			
Terminal connection	(6)	-	Bars
<b>Cable per phase</b>			
Cable per phase	(6)	-	3x500 mm <sup>2</sup>
<b>Short circuit current Icw 1 sec.</b>			
Short circuit current Icw 1 sec.	(6)	kA	25
<p>(1) Standard Rating Conditions for Air to water chillers according to EN14511:2 Outdoor Heat exchanger inlet dry bulb temperature 35°; Indoor heat exchanger inlet water temperature 12°C, outlet water temperature 7°C. Fouling factor = 0</p> <p>(2) Voltage unbalance between phases must be within ± 3%.</p> <p>(3) Maximum running current is based on max compressor absorbed current in its envelope and max fans absorbed current.</p> <p>(4) Based on minimum allowed voltage → Max. current for wire sizing = Max. Running current x 1,1</p> <p>(5) In case of inverter driven compressor, the starting current is zero</p> <p>(6) It may change in case of unit with options or customized unit. Refer to dedicated unit's wiring diagram.</p>			
<p>The data are referred to the unit without additional options.  All data are subject to change without notice. For updated information on project base refer to unit specific wiring diagram and unit's nameplate data.</p>			

EWAD~TZ- XR C + OPT161B – 200 Pa ESP (BRUSHLESS FANS)								
MODEL	notes		C11	C12	H12	C14	C15	H16
Phases		n	3					
Frequency		Hz	50					
Voltage	(2)	V	400					
Voltage Tolerances min/max		%	-10 / +10					
Nominal Running Current	(1)	A	597,1	638,3	679,0	725,2	795,2	862,6
Max. running current	(3)	A	1021	1028	1062	1205	1246	1333
Max. current for wire sizing	(4)	A	1123	1131	1168	1326	1371	1466
Maximum starting current	(5)	A	0	0	0	0	0	0
Fan starting method	(6)	-	EC Brushless Motor					
Max running current per fan	(6)	A	5,50					
Total fans running current	(6)	A	121	132	143	132	143	154
Compressor starting method			Variable Frequency Drive					
Max. running current Compressor #1	(6)	A	370	367	388	440	480	521
Max. running current Compressor #2	(6)	A	370	367	388	440	480	521
Main switch size	(6)	A	1250	1250	1250	1600	1600	1600
Terminal connection	(6)	-	Bars	Bars	Bars	Bars	Bars	Bars
Cable per phase	(6)	-	2x400 mm <sup>2</sup>	2x400 mm <sup>2</sup>	2x400 mm <sup>2</sup>	2x500 mm <sup>2</sup>	2x500 mm <sup>2</sup>	2x500 mm <sup>2</sup>
Short circuit current I <sub>cw</sub> 1 sec.	(6)	kA	25	25	25	25	25	25
<p>(1) Standard Rating Conditions for Air to water chillers according to EN14511:2 Outdoor Heat exchanger inlet dry bulb temperature 35°; Indoor heat exchanger inlet water temperature 12°C, outlet water temperature 7°C. Fouling factor = 0</p> <p>(2) Voltage unbalance between phases must be within ± 3%.</p> <p>(3) Maximum running current is based on max compressor absorbed current in its envelope and max fans absorbed current.</p> <p>(4) Based on minimum allowed voltage → Max. current for wire sizing = Max. Running current x 1,1</p> <p>(5) In case of inverter driven compressor, the starting current is zero</p> <p>(6) It may change in case of unit with options or customized unit. Refer to dedicated unit's wiring diagram.</p> <p>The data are referred to the unit without additional options. All data are subject to change without notice. For updated information on project base refer to unit specific wiring diagram and unit's nameplate data.</p>								

EWAD~TZ- XR C + OPT161B – 200 Pa ESP (BRUSHLESS FANS)			
MODEL	notes		H17
Phases		n	3
Frequency		Hz	50
Voltage	(2)	V	400
Voltage Tolerances min/max		%	-10 / +10
<b>Nominal Running Current</b>			
Nominal Running Current	(1)	A	944,6
<b>Max. running current</b>			
Max. running current	(3)	A	1456
<b>Max. current for wire sizing</b>			
Max. current for wire sizing	(4)	A	1602
<b>Maximum starting current</b>			
Maximum starting current	(5)	A	0
<b>Fan starting method</b>			
Fan starting method	(6)	-	EC Brushless Motor
<b>Max running current per fan</b>			
Max running current per fan	(6)	A	5,50
<b>Total fans running current</b>			
Total fans running current	(6)	A	165
<b>Compressor starting method</b>			
Compressor starting method			Variable Frequency Drive
<b>Max. running current Compressor #1</b>			
Max. running current Compressor #1	(6)	A	562
<b>Max. running current Compressor #2</b>			
Max. running current Compressor #2	(6)	A	562
<b>Main switch size</b>			
Main switch size	(6)	A	2000
<b>Terminal connection</b>			
Terminal connection	(6)	-	Bars
<b>Cable per phase</b>			
Cable per phase	(6)	-	3x500 mm <sup>2</sup>
<b>Short circuit current l<sub>cw</sub> 1 sec.</b>			
Short circuit current l <sub>cw</sub> 1 sec.	(6)	kA	25
<p>(1) Standard Rating Conditions for Air to water chillers according to EN14511:2 Outdoor Heat exchanger inlet dry bulb temperature 35°; Indoor heat exchanger inlet water temperature 12°C, outlet water temperature 7°C. Fouling factor = 0</p> <p>(2) Voltage unbalance between phases must be within ± 3%.</p> <p>(3) Maximum running current is based on max compressor absorbed current in its envelope and max fans absorbed current.</p> <p>(4) Based on minimum allowed voltage → Max. current for wire sizing = Max. Running current x 1,1</p> <p>(5) In case of inverter driven compressor, the starting current is zero</p> <p>(6) It may change in case of unit with options or customized unit. Refer to dedicated unit's wiring diagram.</p>			
<p>The data are referred to the unit without additional options.  All data are subject to change without notice. For updated information on project base refer to unit specific wiring diagram and unit's nameplate data.</p>			



<b>EWAH~TZ- SS C – standard unit</b>										
Model	Sound pressure level @ 1 m from the unit (rif. $2 \times 10^{-5}$ Pa )								Sound pressure Lp @ 1 m	Sound power Lw
	63 Hz	125 Hz	250 Hz	500 Hz	1000 Hz	2000 Hz	4000 Hz	8000 Hz		
	dB								dB(A)	dB(A)
710	81	75	75	79	76	65	68	60	80	101
770	82	76	76	80	70	65	67	60	80	101
880	81	75	75	79	76	65	68	60	80	102
940	81	75	75	79	76	65	68	60	81	103
990	82	76	76	80	78	66	69	61	82	104
H10	83	77	77	81	78	67	70	62	82	105
C11	83	77	78	82	79	68	70	63	83	106
C12	84	79	79	83	80	69	72	64	84	107
C13	85	79	80	79	81	70	67	61	83	105
C14	85	79	80	79	82	70	67	61	83	106
C15	85	79	78	81	82	70	67	61	84	107
C16	85	79	79	82	83	70	66	61	85	108

Sound Performance referred to ASHRAE standard conditions evaporator water in/out = 12.2/6.7°C; ambient = 35.0°C, unit at full load operation; operating fluid: Water; fouling factor = 0,0000176m<sup>2</sup>C/W  
 Sound Power levels are measured in accordance with ISO 9614  
 Sound Pressure levels are measured in accordance with ISO 3744  
 The sound data in the Octave band spectrum is based on calculation, thus intended for reference only and not considering binding.  
 All data are subject to change without notice. For updated information on project base refer to specific selections.  
 NOTE: with exception of OPT76b Sound proof system (COMPRESSOR) the other options from Price List have no impact on sound performances  
 Customized selection made to meet specific project's requirements could lead to change in sound performances. Refer to the customized selection for specific data.

<b>EWAH~TZ- SL C – standard unit</b>										
Model	Sound pressure level @ 1 m from the unit (rif. $2 \times 10^{-5}$ Pa )								Sound pressure Lp @ 1 m	Sound power Lw
	63 Hz	125 Hz	250 Hz	500 Hz	1000 Hz	2000 Hz	4000 Hz	8000 Hz		
	dB								dB(A)	dB(A)
710	81	75	74	75	72	65	68	60	77	98
770	82	76	75	76	69	65	67	60	77	98
880	81	75	75	75	72	65	68	60	77	99
940	81	76	75	76	72	66	68	61	78	100
990	82	76	75	76	73	66	69	61	78	101
H10	82	76	76	77	73	66	69	62	79	101
C11	83	77	76	77	74	67	70	62	79	102
C12	83	78	77	78	75	68	71	63	80	103
C13	85	79	79	77	76	70	67	61	79	102
C14	85	79	79	77	77	70	67	61	79	102
C15	85	79	78	78	77	70	67	61	80	103
C16	85	79	79	78	78	70	66	61	80	104

Sound Performance referred to ASHRAE standard conditions evaporator water in/out = 12.2/6.7°C; ambient = 35.0°C, unit at full load operation; operating fluid: Water; fouling factor = 0,0000176m<sup>2</sup>C/W  
 Sound Power levels are measured in accordance with ISO 9614  
 Sound Pressure levels are measured in accordance with ISO 3744  
 The sound data in the Octave band spectrum is based on calculation, thus intended for reference only and not considering binding.  
 All data are subject to change without notice. For updated information on project base refer to specific selections.  
 NOTE: with exception of OPT76b Sound proof system (COMPRESSOR) the other options from Price List have no impact on sound performances  
 Customized selection made to meet specific project's requirements could lead to change in sound performances. Refer to the customized selection for specific data.

<b>EWAH~TZ- SL C – standard unit + OPT76-b SOUND PROOF SYSTEM (COMPRESSOR)</b>										
Model	Sound pressure level @ 1 m from the unit (rif. $2 \times 10^{-5}$ Pa )								Sound pressure Lp @ 1 m	Sound power Lw
	63 Hz	125 Hz	250 Hz	500 Hz	1000 Hz	2000 Hz	4000 Hz	8000 Hz		
	dB								dB(A)	dB(A)
710	84	75	74	73	69	65	68	60	76	97
770	84	76	75	74	68	65	67	60	76	97
880	84	75	74	73	69	65	68	60	76	98
940	85	76	75	74	69	65	68	61	77	98
990	85	76	75	74	70	66	68	61	77	99
H10	85	76	75	74	70	66	69	61	77	99
C11	86	76	75	74	70	66	69	61	77	100
C12	87	76	75	74	70	67	70	62	78	101
C13	85	79	78	76	73	65	61	60	77	100
C14	85	79	78	76	73	66	61	60	77	100
C15	85	79	78	77	74	66	62	60	78	101
C16	85	79	78	77	74	66	62	60	78	101

Sound Performance referred to ASHRAE standard conditions evaporator water in/out = 12.2/6.7°C; ambient = 35.0°C, unit at full load operation; operating fluid: Water; fouling factor = 0,0000176m<sup>2</sup>C/W  
 Sound Power levels are measured in accordance with ISO 9614  
 Sound Pressure levels are measured in accordance with ISO 3744  
 The sound data in the Octave band spectrum is based on calculation, thus intended for reference only and not considering binding.  
 All data are subject to change without notice. For updated information on project base refer to specific selections.  
 NOTE: with exception of OPT76b Sound proof system (COMPRESSOR) the other options from Price List have no impact on sound performances  
 Customized selection made to meet specific project's requirements could lead to change in sound performances. Refer to the customized selection for specific data.

<b>EWAH~TZ- SR C – standard unit</b>										
Model	Sound pressure level @ 1 m from the unit (rif. $2 \times 10^{-5}$ Pa )								Sound pressure Lp @ 1 m	Sound power Lw
	63 Hz	125 Hz	250 Hz	500 Hz	1000 Hz	2000 Hz	4000 Hz	8000 Hz		
	dB								dB(A)	dB(A)
710	72	66	65	66	64	61	66	58	70	91
770	72	66	65	66	63	61	65	57	70	91
880	73	66	65	66	64	61	65	57	70	92
940	73	67	66	67	64	62	66	58	71	93
990	73	68	67	67	65	63	67	59	72	94
H10	74	68	67	68	65	63	67	59	72	94
C11	74	68	67	68	65	63	67	59	72	95
C12	74	68	67	68	66	64	68	60	73	96
C13	78	72	72	69	70	62	59	59	72	95
C14	78	73	72	70	71	62	60	59	73	95
C15	78	73	71	71	71	62	60	59	73	96
C16	78	73	71	71	72	63	60	59	74	97

Sound Performance referred to ASHRAE standard conditions evaporator water in/out = 12.2/6.7°C; ambient = 35.0°C, unit at full load operation; operating fluid: Water; fouling factor = 0,0000176m<sup>2</sup>C/W  
 Sound Power levels are measured in accordance with ISO 9614  
 Sound Pressure levels are measured in accordance with ISO 3744  
 The sound data in the Octave band spectrum is based on calculation, thus intended for reference only and not considering binding.  
 All data are subject to change without notice. For updated information on project base refer to specific selections.  
 NOTE: with exception of OPT76b Sound proof system (COMPRESSOR) the other options from Price List have no impact on sound performances  
 Customized selection made to meet specific project's requirements could lead to change in sound performances. Refer to the customized selection for specific data.

<b>EWAH~TZ- XS C – standard unit</b>										
Model	Sound pressure level @ 1 m from the unit (rif. $2 \times 10^{-5}$ Pa )								Sound pressure Lp @ 1 m	Sound power Lw
	63 Hz	125 Hz	250 Hz	500 Hz	1000 Hz	2000 Hz	4000 Hz	8000 Hz		
	dB								dB(A)	dB(A)
670	76	70	71	78	67	63	66	60	<b>76</b>	<b>98</b>
780	76	70	71	79	67	63	67	60	<b>78</b>	<b>99</b>
840	75	69	71	79	67	63	67	60	<b>78</b>	<b>100</b>
950	75	69	71	78	75	63	67	59	<b>79</b>	<b>101</b>
C10	75	70	72	79	77	64	68	60	<b>80</b>	<b>103</b>
C11	76	71	73	80	78	66	70	62	<b>82</b>	<b>105</b>
C12	85	79	79	78	80	70	67	61	<b>82</b>	<b>104</b>
C13	85	79	80	79	81	70	67	61	<b>82</b>	<b>105</b>
C14	85	79	80	79	82	70	67	61	<b>83</b>	<b>106</b>
C15	85	79	79	81	82	70	66	61	<b>84</b>	<b>107</b>

Sound Performance referred to ASHRAE standard conditions evaporator water in/out = 12.2/6.7°C; ambient = 35.0°C, unit at full load operation; operating fluid: Water; fouling factor = 0,0000176m<sup>2</sup>°C/W  
 Sound Power levels are measured in accordance with ISO 9614  
 Sound Pressure levels are measured in accordance with ISO 3744  
 The sound data in the Octave band spectrum is based on calculation, thus intended for reference only and not considering binding.  
 All data are subject to change without notice. For updated information on project base refer to specific selections.  
 NOTE: with exception of OPT76b Sound proof system (COMPRESSOR) the other options from Price List have no impact on sound performances  
 Customized selection made to meet specific project's requirements could lead to change in sound performances. Refer to the customized selection for specific data.

<b>EWAH~TZ- XL C – standard unit</b>										
Model	Sound pressure level @ 1 m from the unit (rif. $2 \times 10^{-5}$ Pa )								Sound pressure Lp @ 1 m	Sound power Lw
	63 Hz	125 Hz	250 Hz	500 Hz	1000 Hz	2000 Hz	4000 Hz	8000 Hz		
	dB								dB(A)	dB(A)
670	75	69	68	72	63	61	65	58	<b>72</b>	<b>93</b>
780	75	69	69	73	64	63	66	59	<b>73</b>	<b>95</b>
840	75	69	69	73	64	63	67	59	<b>73</b>	<b>95</b>
950	75	69	69	72	70	63	67	59	<b>74</b>	<b>96</b>
C10	74	69	68	72	70	63	67	59	<b>75</b>	<b>98</b>
C11	75	69	69	74	71	65	69	61	<b>76</b>	<b>99</b>
C12	84	79	78	77	76	70	67	61	<b>79</b>	<b>101</b>
C13	85	79	79	77	76	70	67	61	<b>79</b>	<b>102</b>
C14	85	79	79	77	77	70	67	61	<b>79</b>	<b>102</b>
C15	85	79	79	78	77	70	66	61	<b>80</b>	<b>103</b>

Sound Performance referred to ASHRAE standard conditions evaporator water in/out = 12.2/6.7°C; ambient = 35.0°C, unit at full load operation; operating fluid: Water; fouling factor = 0,0000176m<sup>2</sup>°C/W  
 Sound Power levels are measured in accordance with ISO 9614  
 Sound Pressure levels are measured in accordance with ISO 3744  
 The sound data in the Octave band spectrum is based on calculation, thus intended for reference only and not considering binding.  
 All data are subject to change without notice. For updated information on project base refer to specific selections.  
 NOTE: with exception of OPT76b Sound proof system (COMPRESSOR) the other options from Price List have no impact on sound performances  
 Customized selection made to meet specific project's requirements could lead to change in sound performances. Refer to the customized selection for specific data.

<b>EWAH~TZ- XL C – standard unit + OPT76-b SOUND PROOF SYSTEM (COMPRESSOR)</b>										
Model	Sound pressure level @ 1 m from the unit (rif. $2 \times 10^{-5}$ Pa )								Sound pressure Lp @ 1 m	Sound power Lw
	63 Hz	125 Hz	250 Hz	500 Hz	1000 Hz	2000 Hz	4000 Hz	8000 Hz		
	dB								dB(A)	dB(A)
670	75	68	67	67	62	61	64	58	69	90
780	76	68	67	67	62	61	65	58	70	91
840	76	68	67	68	62	62	66	58	70	92
950	77	68	67	67	65	62	66	58	71	93
C10	78	68	67	68	65	63	67	59	71	94
C11	78	68	67	68	65	63	67	59	72	95
C12	85	79	78	76	73	65	61	60	77	100
C13	85	79	78	76	73	66	61	60	77	100
C14	85	79	78	76	73	66	61	60	78	101
C15	85	79	78	77	74	66	62	60	78	101

Sound Performance referred to ASHRAE standard conditions evaporator water in/out = 12.2/6.7°C; ambient = 35.0°C, unit at full load operation; operating fluid: Water; fouling factor = 0,0000176m<sup>2</sup>°C/W  
 Sound Power levels are measured in accordance with ISO 9614  
 Sound Pressure levels are measured in accordance with ISO 3744  
 The sound data in the Octave band spectrum is based on calculation, thus intended for reference only and not considering binding.  
 All data are subject to change without notice. For updated information on project base refer to specific selections.  
 NOTE: with exception of OPT76b Sound proof system (COMPRESSOR) the other options from Price List have no impact on sound performances  
 Customized selection made to meet specific project's requirements could lead to change in sound performances. Refer to the customized selection for specific data.

<b>EWAH~TZ- XR C – standard unit</b>										
Model	Sound pressure level @ 1 m from the unit (rif. $2 \times 10^{-5}$ Pa )								Sound pressure Lp @ 1 m	Sound power Lw
	63 Hz	125 Hz	250 Hz	500 Hz	1000 Hz	2000 Hz	4000 Hz	8000 Hz		
	dB								dB(A)	dB(A)
670	74	68	67	67	61	60	64	57	69	90
780	74	68	67	67	61	61	65	58	70	91
840	74	68	67	67	61	61	65	58	70	92
950	73	68	67	67	64	62	66	58	71	93
C10	74	68	67	68	65	63	67	59	71	94
C11	74	68	67	68	65	63	67	59	72	95
C12	78	72	71	69	69	61	59	59	72	94
C13	78	72	72	69	70	62	59	59	72	95
C14	78	73	72	70	70	62	60	59	72	96
C15	78	73	71	71	71	62	60	59	73	96

Sound Performance referred to ASHRAE standard conditions evaporator water in/out = 12.2/6.7°C; ambient = 35.0°C, unit at full load operation; operating fluid: Water; fouling factor = 0,0000176m<sup>2</sup>°C/W  
 Sound Power levels are measured in accordance with ISO 9614  
 Sound Pressure levels are measured in accordance with ISO 3744  
 The sound data in the Octave band spectrum is based on calculation, thus intended for reference only and not considering binding.  
 All data are subject to change without notice. For updated information on project base refer to specific selections.  
 NOTE: with exception of OPT76b Sound proof system (COMPRESSOR) the other options from Price List have no impact on sound performances  
 Customized selection made to meet specific project's requirements could lead to change in sound performances. Refer to the customized selection for specific data.

<b>EWAD~TZ- SS C – standard unit</b>										
Model	Sound pressure level @ 1 m from the unit (rif. $2 \times 10^{-5}$ Pa )								Sound pressure Lp @ 1 m	Sound power Lw
	63 Hz	125 Hz	250 Hz	500 Hz	1000 Hz	2000 Hz	4000 Hz	8000 Hz		
	dB								dB(A)	dB(A)
H11	82	76	76	79	76	65	67	60	<b>80</b>	<b>102</b>
H12	81	76	75	79	76	65	67	60	<b>81</b>	<b>103</b>
H13	82	77	77	80	78	66	69	61	<b>82</b>	<b>104</b>
C15	85	79	80	79	77	70	67	61	<b>81</b>	<b>104</b>
C16	85	79	79	78	80	70	67	61	<b>82</b>	<b>105</b>
H17	85	79	80	79	81	70	67	61	<b>82</b>	<b>105</b>
H18	85	79	80	79	81	70	66	61	<b>83</b>	<b>106</b>
H19	85	79	79	81	82	70	66	61	<b>84</b>	<b>107</b>

Sound Performance referred to ASHRAE standard conditions evaporator water in/out = 12.2/6.7°C; ambient = 35.0°C, unit at full load operation; operating fluid: Water; fouling factor = 0,0000176m<sup>2</sup>°C/W  
 Sound Power levels are measured in accordance with ISO 9614  
 Sound Pressure levels are measured in accordance with ISO 3744  
 The sound data in the Octave band spectrum is based on calculation, thus intended for reference only and not considering binding.  
 All data are subject to change without notice. For updated information on project base refer to specific selections.  
 NOTE: with exception of OPT76b Sound proof system (COMPRESSOR) the other options from Price List have no impact on sound performances  
 Customized selection made to meet specific project's requirements could lead to change in sound performances. Refer to the customized selection for specific data.

<b>EWAD~TZ- SL C – standard unit</b>										
Model	Sound pressure level @ 1 m from the unit (rif. $2 \times 10^{-5}$ Pa )								Sound pressure Lp @ 1 m	Sound power Lw
	63 Hz	125 Hz	250 Hz	500 Hz	1000 Hz	2000 Hz	4000 Hz	8000 Hz		
	dB								dB(A)	dB(A)
H11	82	76	75	75	71	65	67	60	<b>77</b>	<b>100</b>
H12	82	76	75	75	72	65	68	60	<b>78</b>	<b>100</b>
H13	82	76	76	76	73	66	68	61	<b>78</b>	<b>101</b>
C15	85	79	79	77	74	70	67	61	<b>78</b>	<b>101</b>
C16	85	79	78	77	75	70	67	61	<b>79</b>	<b>101</b>
H17	85	79	79	77	76	70	67	61	<b>79</b>	<b>102</b>
H18	85	79	79	77	77	70	66	61	<b>79</b>	<b>103</b>
H19	85	79	79	78	77	70	66	61	<b>80</b>	<b>103</b>

Sound Performance referred to ASHRAE standard conditions evaporator water in/out = 12.2/6.7°C; ambient = 35.0°C, unit at full load operation; operating fluid: Water; fouling factor = 0,0000176m<sup>2</sup>°C/W  
 Sound Power levels are measured in accordance with ISO 9614  
 Sound Pressure levels are measured in accordance with ISO 3744  
 The sound data in the Octave band spectrum is based on calculation, thus intended for reference only and not considering binding.  
 All data are subject to change without notice. For updated information on project base refer to specific selections.  
 NOTE: with exception of OPT76b Sound proof system (COMPRESSOR) the other options from Price List have no impact on sound performances  
 Customized selection made to meet specific project's requirements could lead to change in sound performances. Refer to the customized selection for specific data.

<b>EWAD~TZ- SL C – standard unit + OPT76-b SOUND PROOF SYSTEM (COMPRESSOR)</b>										
Model	Sound pressure level @ 1 m from the unit (rif. $2 \times 10^{-5}$ Pa )								Sound pressure Lp @ 1 m	Sound power Lw
	63 Hz	125 Hz	250 Hz	500 Hz	1000 Hz	2000 Hz	4000 Hz	8000 Hz		
	dB								dB(A)	dB(A)
H11	85	77	76	75	70	66	68	61	<b>77</b>	<b>99</b>
H12	85	77	76	74	70	66	68	61	<b>77</b>	<b>99</b>
H13	86	76	75	74	70	66	68	61	<b>77</b>	<b>100</b>
C15	85	79	78	76	72	65	61	60	<b>77</b>	<b>100</b>
C16	85	79	78	76	73	65	61	60	<b>77</b>	<b>100</b>
H17	85	79	78	76	73	66	61	60	<b>77</b>	<b>100</b>
H18	85	79	78	77	73	66	61	60	<b>78</b>	<b>101</b>
H19	85	79	78	77	74	66	62	60	<b>78</b>	<b>101</b>

Sound Performance referred to ASHRAE standard conditions evaporator water in/out = 12.2/6.7°C; ambient = 35.0°C, unit at full load operation; operating fluid: Water; fouling factor = 0,0000176m<sup>2</sup>°C/W  
 Sound Power levels are measured in accordance with ISO 9614  
 Sound Pressure levels are measured in accordance with ISO 3744  
 The sound data in the Octave band spectrum is based on calculation, thus intended for reference only and not considering binding.  
 All data are subject to change without notice. For updated information on project base refer to specific selections.  
 NOTE: with exception of OPT76b Sound proof system (COMPRESSOR) the other options from Price List have no impact on sound performances  
 Customized selection made to meet specific project's requirements could lead to change in sound performances. Refer to the customized selection for specific data.

<b>EWAD~TZ- SR C – standard unit</b>										
Model	Sound pressure level @ 1 m from the unit (rif. $2 \times 10^{-5}$ Pa )								Sound pressure Lp @ 1 m	Sound power Lw
	63 Hz	125 Hz	250 Hz	500 Hz	1000 Hz	2000 Hz	4000 Hz	8000 Hz		
	dB								dB(A)	dB(A)
H11	74	68	67	67	64	62	66	58	<b>70</b>	<b>93</b>
H12	74	68	67	67	65	62	66	59	<b>71</b>	<b>93</b>
H13	74	69	68	68	66	63	67	59	<b>71</b>	<b>94</b>
C15	78	72	72	69	67	61	59	59	<b>71</b>	<b>94</b>
C16	78	72	71	69	69	61	59	59	<b>71</b>	<b>94</b>
H17	78	72	71	69	69	61	59	59	<b>72</b>	<b>95</b>
H18	78	73	72	70	70	62	60	59	<b>72</b>	<b>96</b>
H19	78	73	71	71	71	62	60	59	<b>73</b>	<b>96</b>

Sound Performance referred to ASHRAE standard conditions evaporator water in/out = 12.2/6.7°C; ambient = 35.0°C, unit at full load operation; operating fluid: Water; fouling factor = 0,0000176m<sup>2</sup>°C/W  
 Sound Power levels are measured in accordance with ISO 9614  
 Sound Pressure levels are measured in accordance with ISO 3744  
 The sound data in the Octave band spectrum is based on calculation, thus intended for reference only and not considering binding.  
 All data are subject to change without notice. For updated information on project base refer to specific selections.  
 NOTE: with exception of OPT76b Sound proof system (COMPRESSOR) the other options from Price List have no impact on sound performances  
 Customized selection made to meet specific project's requirements could lead to change in sound performances. Refer to the customized selection for specific data.

<b>EWAD~TZ- XS C – standard unit</b>										
Model	Sound pressure level @ 1 m from the unit (rif. $2 \times 10^{-5}$ Pa )								Sound pressure Lp @ 1 m	Sound power Lw
	63 Hz	125 Hz	250 Hz	500 Hz	1000 Hz	2000 Hz	4000 Hz	8000 Hz		
	dB								dB(A)	dB(A)
<b>C11</b>	76	70	69	73	64	63	66	59	<b>73</b>	<b>95</b>
<b>C12</b>	75	69	68	71	69	62	66	59	<b>73</b>	<b>96</b>
<b>H12</b>	75	69	69	72	69	63	67	59	<b>74</b>	<b>97</b>
<b>C14</b>	84	79	78	77	74	70	67	61	<b>78</b>	<b>101</b>
<b>C15</b>	85	79	79	77	74	70	67	61	<b>78</b>	<b>101</b>
<b>H16</b>	85	79	79	77	75	70	66	61	<b>79</b>	<b>102</b>
<b>H17</b>	85	79	79	77	76	70	66	61	<b>79</b>	<b>102</b>

Sound Performance referred to ASHRAE standard conditions evaporator water in/out = 12.2/6.7°C; ambient = 35.0°C, unit at full load operation; operating fluid: Water; fouling factor = 0,0000176m<sup>2</sup>C/W  
 Sound Power levels are measured in accordance with ISO 9614  
 Sound Pressure levels are measured in accordance with ISO 3744  
 The sound data in the Octave band spectrum is based on calculation, thus intended for reference only and not considering binding.  
 All data are subject to change without notice. For updated information on project base refer to specific selections.  
 NOTE: with exception of OPT76b Sound proof system (COMPRESSOR) the other options from Price List have no impact on sound performances  
 Customized selection made to meet specific project's requirements could lead to change in sound performances. Refer to the customized selection for specific data.

<b>EWAD~TZ- XS C – standard unit + OPT76-b SOUND PROOF SYSTEM (COMPRESSOR)</b>										
Model	Sound pressure level @ 1 m from the unit (rif. $2 \times 10^{-5}$ Pa )								Sound pressure Lp @ 1 m	Sound power Lw
	63 Hz	125 Hz	250 Hz	500 Hz	1000 Hz	2000 Hz	4000 Hz	8000 Hz		
	dB								dB(A)	dB(A)
<b>C11</b>	77	69	68	68	62	62	65	58	<b>70</b>	<b>92</b>
<b>C12</b>	77	68	67	67	64	62	65	58	<b>70</b>	<b>93</b>
<b>H12</b>	77	68	67	67	65	62	66	59	<b>71</b>	<b>94</b>
<b>C14</b>	85	79	78	76	72	65	60	60	<b>77</b>	<b>100</b>
<b>C15</b>	85	79	78	76	72	65	61	60	<b>77</b>	<b>100</b>
<b>H16</b>	85	79	78	76	73	65	61	60	<b>77</b>	<b>100</b>
<b>H17</b>	85	79	78	76	73	66	61	60	<b>77</b>	<b>101</b>

Sound Performance referred to ASHRAE standard conditions evaporator water in/out = 12.2/6.7°C; ambient = 35.0°C, unit at full load operation; operating fluid: Water; fouling factor = 0,0000176m<sup>2</sup>C/W  
 Sound Power levels are measured in accordance with ISO 9614  
 Sound Pressure levels are measured in accordance with ISO 3744  
 The sound data in the Octave band spectrum is based on calculation, thus intended for reference only and not considering binding.  
 All data are subject to change without notice. For updated information on project base refer to specific selections.  
 NOTE: with exception of OPT76b Sound proof system (COMPRESSOR) the other options from Price List have no impact on sound performances  
 Customized selection made to meet specific project's requirements could lead to change in sound performances. Refer to the customized selection for specific data.



EWAD~TZ- XR C – standard unit										
Model	Sound pressure level @ 1 m from the unit (rif. $2 \times 10^{-5}$ Pa )								Sound pressure $L_p$ @ 1 m	Sound power $L_w$
	63 Hz	125 Hz	250 Hz	500 Hz	1000 Hz	2000 Hz	4000 Hz	8000 Hz		
	dB								dB(A)	dB(A)
C11	75	69	68	68	62	62	65	58	70	92
C12	74	68	67	67	64	62	65	58	70	93
H12	74	68	67	67	65	62	66	59	71	94
C14	78	72	72	69	67	61	59	59	71	93
C15	78	72	72	69	67	61	59	59	71	94
H16	78	72	71	69	69	61	59	59	71	95
H17	78	73	72	69	70	62	59	59	72	95

Sound Performance referred to ASHRAE standard conditions evaporator water in/out = 12.2/6.7°C; ambient = 35.0°C, unit at full load operation; operating fluid: Water; fouling factor = 0,0000176m<sup>2</sup>°C/W  
 Sound Power levels are measured in accordance with ISO 9614  
 Sound Pressure levels are measured in accordance with ISO 3744  
 The sound data in the Octave band spectrum is based on calculation, thus intended for reference only and not considering binding.  
 All data are subject to change without notice. For updated information on project base refer to specific selections.  
 NOTE: with exception of OPT76b Sound proof system (COMPRESSOR) the other options from Price List have no impact on sound performances  
 Customized selection made to meet specific project's requirements could lead to change in sound performances. Refer to the customized selection for specific data.

Despite "Sound power" and "Sound pressure" both share the same unit of measure, the decibel (dB), and the term "sound level" is commonly substituted for each they represent two distinct characteristics of sound.

**Sound power** is the acoustical energy emitted by the sound source. it is an absolute value and is not affected by the environment.

**Sound pressure** is a pressure disturbance in the atmosphere whose intensity is influenced not only by the strength of the source, but also by the surroundings and the distance from the source to the receiver.

Although dB is commonly used when referring to measuring sound, humans do not hear all frequencies equally. In order to account for this, corrections have been created to give a loudness measurement that takes into account how the human ear actually perceives sound. The most common of these corrections is the "A" weighting (different weights are applied at different frequencies). Values that have been corrected using the "A" weighting system are shown using units of dB(A). Values not corrected to account for human hearing are written using units of dB. The sound spectrum in octave band is reported in dB while the overall value of Sound power and pressure are in dB(A).

To calculate the sound pressure at different distances from the chiller the generic calculation of sound power from sound pressure is as follows:

$$L_p = L_w - 10 * \log_{10} A_d$$

Where  $A_d$  is the surface around the chiller calculated at the specific distance  $d$

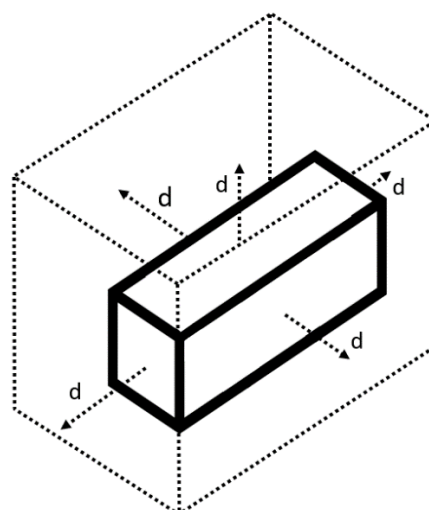



<b>EWAH~TZ- SS C – standard unit</b>										
<b>Model</b>	<b>Sound pressure at different distances [dB(A)]</b>									
	<b>@ 1 m</b>	<b>@ 2 m</b>	<b>@ 3 m</b>	<b>@ 4 m</b>	<b>@ 5 m</b>	<b>@ 6 m</b>	<b>@ 7 m</b>	<b>@ 8 m</b>	<b>@ 9 m</b>	<b>@ 10 m</b>
710	80	78	76	74	73	72	71	70	69	69
770	80	77	76	74	73	72	71	70	69	68
880	80	78	76	75	73	72	71	70	70	69
940	81	79	77	76	74	73	72	71	71	70
990	82	80	78	77	75	74	73	73	72	71
H10	82	80	79	77	76	75	74	73	72	72
C11	83	81	79	78	77	76	75	74	73	72
C12	84	82	81	79	78	77	76	76	75	74
C13	83	81	79	78	76	75	74	74	73	72
C14	83	81	80	78	77	76	75	74	74	73
C15	84	82	80	79	78	77	76	75	74	74
C16	85	83	81	80	79	78	77	76	75	74

<b>EWAH~TZ- SL C – standard unit</b>										
<b>Model</b>	<b>Sound pressure at different distances [dB(A)]</b>									
	<b>@ 1 m</b>	<b>@ 2 m</b>	<b>@ 3 m</b>	<b>@ 4 m</b>	<b>@ 5 m</b>	<b>@ 6 m</b>	<b>@ 7 m</b>	<b>@ 8 m</b>	<b>@ 9 m</b>	<b>@ 10 m</b>
710	77	75	73	72	70	69	68	67	67	66
770	77	75	73	71	70	69	68	67	66	66
880	77	75	73	72	71	69	68	68	67	66
940	78	76	74	72	71	70	69	68	68	67
990	78	76	75	73	72	71	70	69	68	68
H10	79	77	75	74	72	71	70	70	69	68
C11	79	77	76	74	73	72	71	70	69	69
C12	80	78	77	75	74	73	72	71	71	70
C13	79	77	75	74	73	72	71	70	69	68
C14	79	77	76	74	73	72	71	70	70	69
C15	80	78	76	75	74	73	72	71	70	70
C16	80	78	77	75	74	73	72	72	71	70

<b>EWAH~TZ- SL C – standard unit + OPT76-b SOUND PROOF SYSTEM (COMPRESSOR)</b>										
<b>Model</b>	<b>Sound pressure at different distances [dB(A)]</b>									
	<b>@ 1 m</b>	<b>@ 2 m</b>	<b>@ 3 m</b>	<b>@ 4 m</b>	<b>@ 5 m</b>	<b>@ 6 m</b>	<b>@ 7 m</b>	<b>@ 8 m</b>	<b>@ 9 m</b>	<b>@ 10 m</b>
710	76	74	72	70	69	68	67	66	65	65
770	76	74	72	70	69	68	67	66	65	65
880	76	74	72	71	69	68	67	67	66	65
940	77	74	73	71	70	69	68	67	66	66
990	77	75	73	72	70	69	68	68	67	66
H10	77	75	73	72	71	70	69	68	67	66
C11	77	75	74	72	71	70	69	68	68	67
C12	78	76	74	73	72	71	70	69	68	67
C13	77	75	74	72	71	70	69	68	67	67
C14	77	75	74	72	71	70	69	69	68	67
C15	78	76	74	73	72	71	70	69	68	68
C16	78	76	74	73	72	71	70	69	69	68

EWAH~TZ- SR C – standard unit										
Model	Sound pressure at different distances [dB(A)]									
	@ 1 m	@ 2 m	@ 3 m	@ 4 m	@ 5 m	@ 6 m	@ 7 m	@ 8 m	@ 9 m	@ 10 m
710	70	68	66	64	63	62	61	60	59	59
770	70	68	66	64	63	62	61	60	59	58
880	70	68	66	65	63	62	61	60	60	59
940	71	69	67	65	64	63	62	61	60	60
990	72	69	68	66	65	64	63	62	61	61
H10	72	70	68	67	66	64	64	63	62	61
C11	72	70	69	67	66	65	64	63	63	62
C12	73	71	70	68	67	66	65	65	64	63
C13	72	70	68	67	66	65	64	63	62	62
C14	73	71	69	68	66	65	64	64	63	62
C15	73	71	69	68	67	66	65	64	64	63
C16	74	72	70	69	68	67	66	65	64	63

EWAH~TZ- XS C – standard unit										
Model	Sound pressure at different distances [dB(A)]									
	@ 1 m	@ 2 m	@ 3 m	@ 4 m	@ 5 m	@ 6 m	@ 7 m	@ 8 m	@ 9 m	@ 10 m
670	76	74	72	71	69	68	67	66	66	65
780	78	76	74	72	71	70	69	68	67	67
840	78	76	74	73	71	70	69	68	68	67
950	79	77	75	74	73	72	71	70	69	68
C10	80	78	77	75	74	73	72	71	71	70
C11	82	80	78	77	76	75	74	73	72	72
C12	82	80	78	77	76	75	74	73	72	71
C13	82	80	79	77	76	75	74	74	73	72
C14	83	81	79	78	77	76	75	74	74	73
C15	84	82	80	79	78	77	76	75	74	74

EWAH~TZ- XL C – standard unit										
Model	Sound pressure at different distances [dB(A)]									
	@ 1 m	@ 2 m	@ 3 m	@ 4 m	@ 5 m	@ 6 m	@ 7 m	@ 8 m	@ 9 m	@ 10 m
670	72	70	68	66	65	64	63	62	61	60
780	73	71	69	68	66	65	64	63	63	62
840	73	71	69	68	67	65	65	64	63	62
950	74	72	70	69	68	67	66	65	64	63
C10	75	73	71	70	69	68	67	66	65	65
C11	76	74	73	71	70	69	68	68	67	66
C12	79	77	75	73	72	71	70	70	69	68
C13	79	77	75	74	73	72	71	70	69	69
C14	79	77	76	74	73	72	71	71	70	69
C15	80	78	76	75	74	73	72	71	70	70

<b>EWAH~TZ- XL C – standard unit + OPT76-b SOUND PROOF SYSTEM (COMPRESSOR)</b>										
<b>Model</b>	<b>Sound pressure at different distances [dB(A)]</b>									
	<b>@ 1 m</b>	<b>@ 2 m</b>	<b>@ 3 m</b>	<b>@ 4 m</b>	<b>@ 5 m</b>	<b>@ 6 m</b>	<b>@ 7 m</b>	<b>@ 8 m</b>	<b>@ 9 m</b>	<b>@ 10 m</b>
670	69	67	65	64	62	61	60	59	58	58
780	70	68	66	64	63	62	61	60	59	59
840	70	68	66	65	63	62	61	61	60	59
950	71	69	67	66	64	63	62	62	61	60
C10	71	69	68	66	65	64	63	62	62	61
C11	72	70	69	67	66	65	64	63	63	62
C12	77	75	73	72	71	70	69	68	67	67
C13	77	75	74	72	71	70	69	68	68	67
C14	78	76	74	73	71	70	70	69	68	67
C15	78	76	74	73	72	71	70	69	68	68

<b>EWAH~TZ- XR C – standard unit</b>										
<b>Model</b>	<b>Sound pressure at different distances [dB(A)]</b>									
	<b>@ 1 m</b>	<b>@ 2 m</b>	<b>@ 3 m</b>	<b>@ 4 m</b>	<b>@ 5 m</b>	<b>@ 6 m</b>	<b>@ 7 m</b>	<b>@ 8 m</b>	<b>@ 9 m</b>	<b>@ 10 m</b>
670	69	67	65	64	62	61	60	59	58	58
780	70	68	66	64	63	62	61	60	59	59
840	70	68	66	65	63	62	61	61	60	59
950	71	69	67	66	64	63	62	62	61	60
C10	71	69	68	66	65	64	63	62	62	61
C11	72	70	69	67	66	65	64	63	63	62
C12	72	69	68	66	65	64	63	63	62	61
C13	72	70	68	67	66	65	64	63	62	62
C14	72	70	69	68	66	65	64	64	63	62
C15	73	71	69	68	67	66	65	64	64	63

<b>EWAD~TZ- SS C – standard unit</b>										
<b>Model</b>	<b>Sound pressure at different distances [dB(A)]</b>									
	<b>@ 1 m</b>	<b>@ 2 m</b>	<b>@ 3 m</b>	<b>@ 4 m</b>	<b>@ 5 m</b>	<b>@ 6 m</b>	<b>@ 7 m</b>	<b>@ 8 m</b>	<b>@ 9 m</b>	<b>@ 10 m</b>
H11	80	78	76	75	73	72	71	71	70	69
H12	81	79	77	75	74	73	72	71	71	70
H13	82	80	78	77	75	74	73	73	72	71
C15	81	79	77	76	75	74	73	72	71	71
C16	82	80	78	77	76	75	74	73	72	71
H17	82	80	79	77	76	75	74	74	73	72
H18	83	81	79	78	77	76	75	74	74	73
H19	84	82	80	79	78	77	76	75	74	74

<b>EWAD~TZ- SL C – standard unit</b>										
<b>Model</b>	<b>Sound pressure at different distances [dB(A)]</b>									
	<b>@ 1 m</b>	<b>@ 2 m</b>	<b>@ 3 m</b>	<b>@ 4 m</b>	<b>@ 5 m</b>	<b>@ 6 m</b>	<b>@ 7 m</b>	<b>@ 8 m</b>	<b>@ 9 m</b>	<b>@ 10 m</b>
H11	77	75	74	72	71	70	69	68	68	67
H12	78	76	74	73	72	70	70	69	68	67
H13	78	76	75	73	72	71	70	69	69	68
C15	78	76	75	73	72	71	70	69	68	68
C16	79	77	75	74	72	71	70	70	69	68
H17	79	77	75	74	73	72	71	70	69	69
H18	79	77	76	74	73	72	71	71	70	69
H19	80	78	76	75	74	73	72	71	70	70

<b>EWAD~TZ- SL C – standard unit + OPT76-b SOUND PROOF SYSTEM (COMPRESSOR)</b>										
<b>Model</b>	<b>Sound pressure at different distances [dB(A)]</b>									
	<b>@ 1 m</b>	<b>@ 2 m</b>	<b>@ 3 m</b>	<b>@ 4 m</b>	<b>@ 5 m</b>	<b>@ 6 m</b>	<b>@ 7 m</b>	<b>@ 8 m</b>	<b>@ 9 m</b>	<b>@ 10 m</b>
H11	77	75	73	71	70	69	68	67	67	66
H12	77	75	73	72	70	69	68	68	67	66
H13	77	75	73	72	71	70	69	68	67	67
C15	77	75	73	72	71	70	69	68	67	66
C16	77	75	74	72	71	70	69	68	68	67
H17	77	75	74	72	71	70	69	69	68	67
H18	78	76	74	73	72	71	70	69	68	67
H19	78	76	74	73	72	71	70	69	68	68

EWAD~TZ- SR C – standard unit										
Model	Sound pressure at different distances [dB(A)]									
	@ 1 m	@ 2 m	@ 3 m	@ 4 m	@ 5 m	@ 6 m	@ 7 m	@ 8 m	@ 9 m	@ 10 m
H11	69	67	65	64	63	62	61	60	59	58
H12	69	67	65	64	62	61	60	60	59	58
H13	69	67	65	64	63	62	61	60	59	59
C15	70	68	66	65	64	63	62	61	60	59
C16	71	69	67	66	65	64	63	62	61	60
H17	71	69	68	66	65	64	63	62	62	61
H18	72	70	68	67	66	65	64	63	62	62
H19	73	71	70	68	67	66	65	64	64	63

EWAD~TZ- XS C – standard unit										
Model	Sound pressure at different distances [dB(A)]									
	@ 1 m	@ 2 m	@ 3 m	@ 4 m	@ 5 m	@ 6 m	@ 7 m	@ 8 m	@ 9 m	@ 10 m
C11	73	71	69	68	67	66	65	64	63	62
C12	73	71	69	68	67	66	65	64	63	62
H12	74	72	70	69	68	67	66	65	64	63
C14	78	76	74	73	72	71	70	69	68	67
C15	78	76	75	73	72	71	70	69	69	68
H16	79	77	75	74	72	71	71	70	69	68
H17	79	77	75	74	73	72	71	70	69	69

EWAD~TZ- XS C – standard unit + OPT76-b SOUND PROOF SYSTEM (COMPRESSOR)										
Model	Sound pressure at different distances [dB(A)]									
	@ 1 m	@ 2 m	@ 3 m	@ 4 m	@ 5 m	@ 6 m	@ 7 m	@ 8 m	@ 9 m	@ 10 m
C11	70	68	66	65	64	63	62	61	60	59
C12	70	68	66	65	64	63	62	61	60	60
H12	71	69	67	66	65	64	63	62	61	60
C14	77	75	73	72	71	70	69	68	67	66
C15	77	75	73	72	71	70	69	68	67	67
H16	77	75	74	72	71	70	69	68	68	67
H17	78	76	74	73	72	71	70	69	68	68

EWAD~TZ- XR C – standard unit										
Model	Sound pressure at different distances [dB(A)]									
	@ 1 m	@ 2 m	@ 3 m	@ 4 m	@ 5 m	@ 6 m	@ 7 m	@ 8 m	@ 9 m	@ 10 m
C11	70	68	66	65	64	63	62	61	60	59
C12	70	68	66	65	64	63	62	61	60	60
H12	71	69	67	66	65	64	63	62	61	60
C14	71	69	67	66	64	63	62	62	61	60
C15	71	69	67	66	65	64	63	62	61	61
H16	71	69	68	67	65	64	63	63	62	61
H17	72	70	68	67	66	65	64	63	62	62

**EWAH~TZ-C – Operating Envelope R1234ze**

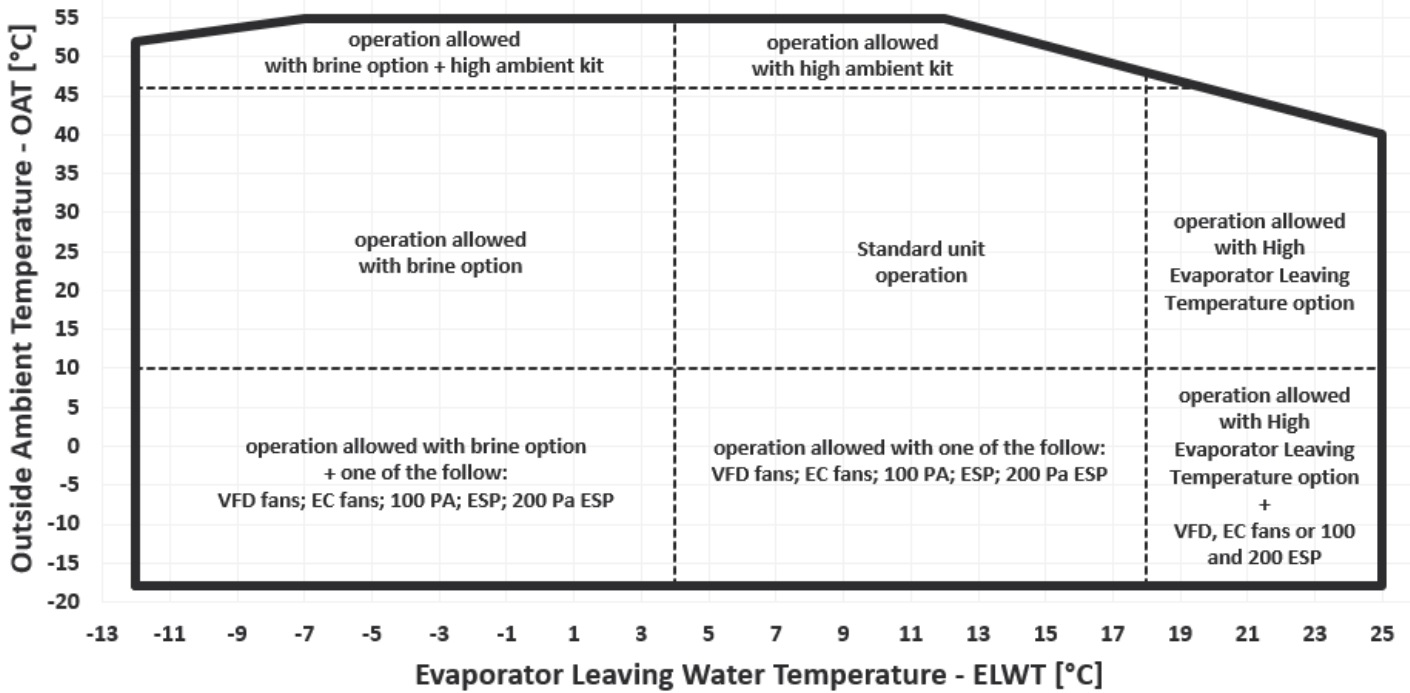

The above graphic represents a guideline about the operating limits of the range. Please refer to the latest Chiller Selection Software (CSS) for real operating limits working conditions for specific model and configuration.

For operation with EWLWT below 4°C, the unit must operate with glycol mixture. The glycol percentage must be provided according to the minimum ELWT needed.

Below the temperature limits for proper chiller operation:

- Min. Evaporator Entering Temperature during operation: -4°C
- Max. Evaporator Entering Temperature during operation: +26°C
  
- Min. Evaporator deltaT during full load operation: 3K
- Max. Evaporator deltaT during full load operation: 8K
  
- Min. Partial Heat Recovery exchanger temperature during operation: +25°C
- Max. Partial Heat Recovery exchanger temperature during operation: +60°C
- Min. Partial Heat recovery deltaT during full load operation: 4K
- Max. Partial Heat recovery deltaT during full load operation: 10K
  
- Min. Total Heat Recovery exchanger temperature during operation: +25°C \*\*
- Max. Total Heat Recovery exchanger temperature during operation: +55°C
- Min. Total Heat recovery deltaT during full load operation: 4K
- Max. Total Heat recovery deltaT during full load operation: 10K

\*maximum allowed temperature during start-up operation.

\*\* the installation of the 3 ways valve is recommended (see dedicated "Heat recovery" paragraph)

### EWAD~TZ-C – Operating Envelope R134a

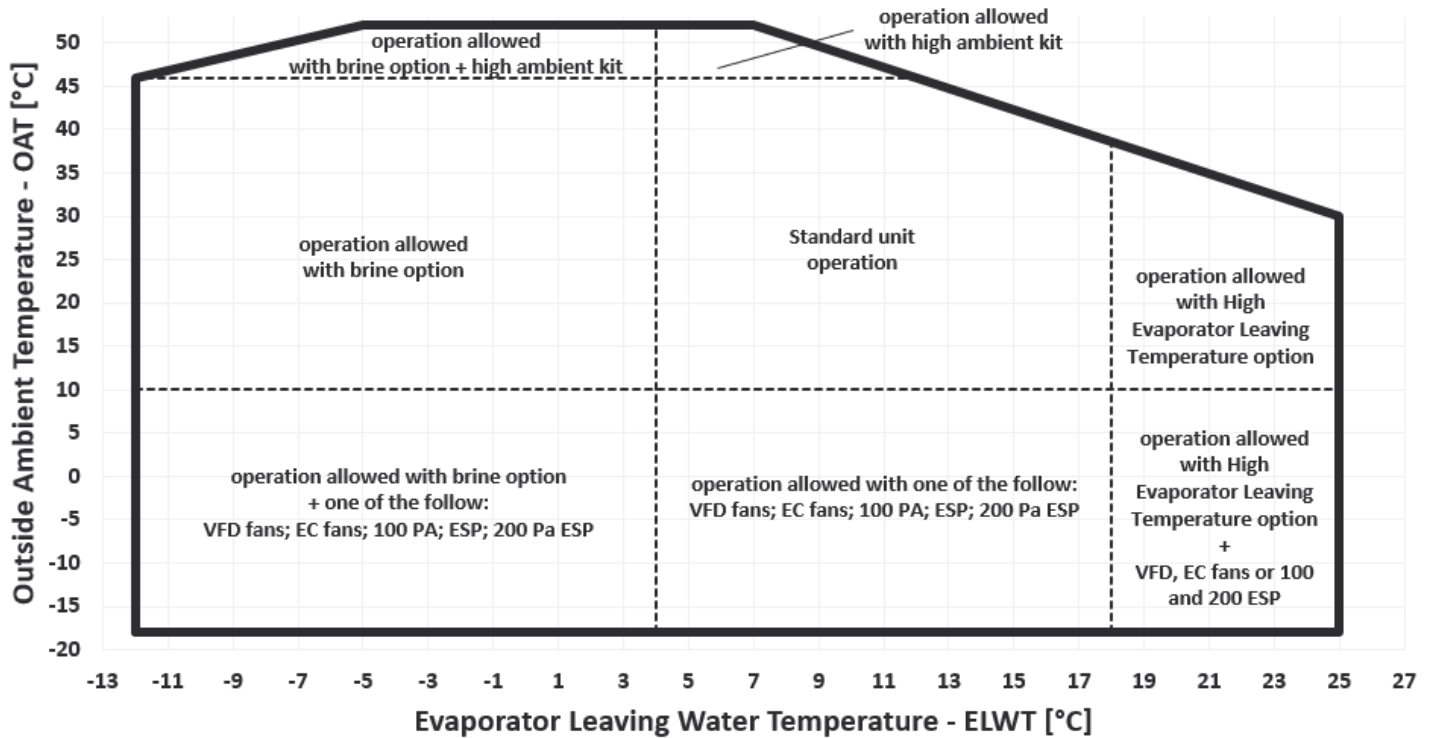

The above graphic represents a guideline about the operating limits of the range. Please refer to the latest Chiller Selection Software (CSS) for real operating limits working conditions for specific model and configuration.

For operation with ELWT below 4°C, the unit must operate with glycol mixture. The glycol percentage must be provided according to the minimum ELWT needed.

Below the temperature limits for proper chiller operation:

- Min. Evaporator Entering Temperature during operation: -4°C
- Max. Evaporator Entering Temperature during operation: +26°C
  
- Min. Evaporator deltaT during full load operation: 3K
- Max. Evaporator deltaT during full load operation: 9K
  
- Min. Partial Heat Recovery exchanger temperature during operation: +25°C
- Max. Partial Heat Recovery exchanger temperature during operation: +60°C
- Min. Partial Heat recovery deltaT during full load operation: 4K
- Max. Partial Heat recovery deltaT during full load operation: 10K
  
- Min. Total Heat Recovery exchanger temperature during operation: +25°C \*\*
- Max. Total Heat Recovery exchanger temperature during operation: +55°C
- Min. Total Heat recovery deltaT during full load operation: 4K
- Max. Total Heat recovery deltaT during full load operation: 10K

\*maximum allowed temperature during start-up operation.

\*\* the installation of the 3 way valve is recommended (see dedicated "Heat recovery" paragraph)

**Additional Pressure Resistance on condenser airflow**

EWA(H)(D)~TZC chiller is design for outdoor installation with free discharge on the condenser inlet/outlet. All data are declared considering the unit installed without any additional pressure drop for the condenser air flow and in compliancy with the installation prescriptions.

Any additional pressure resistance added on the condenser air flow will cause the reduction of the air flow and so a derating of the condenser performance. The different performance of the condenser reflects in a loss of cooling capacity and increased compressor power input.

Within certain limit is possible to add pressure resistance on the condenser discharge of the standard unit. The additional pressure resistance is referred to the standard air-flow (refer to the Specification tables for the air flow rate for the specific unit).

Example: APR = 30 Pa for unit EWAHC11TZSSC2 means that the 30 Pa are referred to 121728 l/s.

Below a graphic representation of the

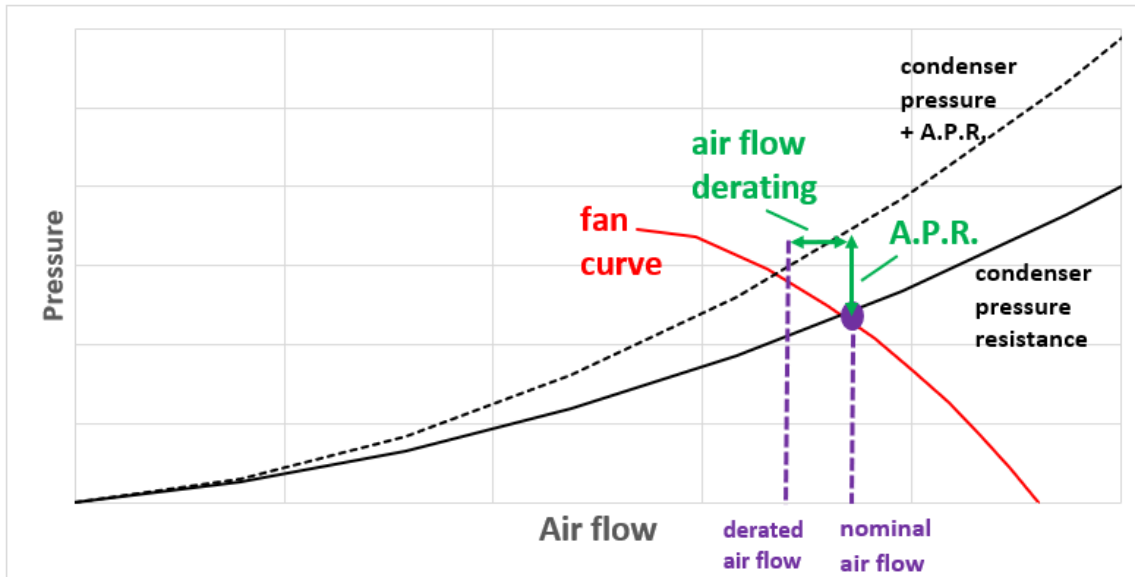

In the following tables are indicated the correction factors for cooling capacity, compressor power input and max operating temperature according different levels of Additional Pressure Resistance (A.P.R.).

Unit with fans @ 900 RPM			
A.P.R [Pa]	Cooling Capacity correction	Compressor Power input correction	Max. operating ambient correction
0	1	1	0°C
30	0,99	1,01	-0,5°C
50	0,98	1,02	-1,0°C
70	0,96	1,04	-1,5°C
100	0,95	1,06	-3,0°C

Unit with fans @ 700 RPM			
A.P.R [Pa]	Cooling Capacity correction	Compressor Power input correction	Max. operating ambient correction
0	1	1	0°C
30	0,96	1,04	-1,5
50	0,95	1,06	-3



**Minimum glycol percentage for low air ambient temperature to prevent freezing of the hydraulic circuit**

<b>Ambient temperature [°C]</b>	<b>-3</b>	<b>-8</b>	<b>-15</b>	<b>-20</b>
<b>Ethylene glycol [%]</b>	10	20	30	40
<b>Propylene Glycol [%]</b>	10	20	30	40

In presence of glycol in the water system the performance will be affected. Refer to the selection software. All machine protection systems, such as antifreeze, and low-pressure protection will need to be adjusted in accordance to the type and percentage of the glycol.

**Air heat exchanger - Altitude correction factors**

<b>Elevation above sea level</b>	<b>[m]</b>	<b>0</b>	<b>300</b>	<b>600</b>	<b>900</b>	<b>1200</b>	<b>1500</b>	<b>1800</b>
<b>barometric pressure</b>	<b>[mbar]</b>	<b>1013</b>	<b>977</b>	<b>942</b>	<b>908</b>	<b>875</b>	<b>843</b>	<b>812</b>
<b>Cooling capacity correction factors</b>		1	0,993	0,986	0,979	0,973	0,967	0,96
<b>Power input correction factors</b>		1	1,005	1,009	1,015	1,021	1,026	1,031

Maximum operating altitude is 1800 m above sea level.  
Contact factory if the unit has to be installed 1000 m above the sea level.

**System water volume**

All chilled water systems need adequate time to recognize a load change to avoid short cycling of the compressors or loss of control. The potential for short cycling usually exists when the building load falls below the minimum chiller plant capacity or on close-coupled systems with very small water volumes. Design considerations for water volume are the minimum cooling load, the minimum chiller plant capacity during the low load period and the desired cycle time for the compressors. Assuming that there are no sudden load changes and that the chiller plant has reasonable turndown, a rule of thumb of "3,5 liters per kW" is often used. This consideration refers to the water volume always flowing through the unit. A properly designed storage tank should be added if the system components do not provide sufficient water volume.

**Variable flow rates**

Many chillers system control and energy optimization strategies require significant changes in evaporator water flow rates. DAIKIN TZ C chillers are well suited to take full advantage of these energy saving opportunities. The evaporators are selected to operate in variable water flow rate regimes.

Both excessively high and excessively low fluid flow rates should be avoided. Excessively high fluid flow rates will result in high fluid pressure drops, high pumping power, and potentially tube erosion or damage.

Excessively low fluid flow rates should also be avoided as they will result in poor heat transfer, high compressor power, and sedimentation. In addition to that, is important to remind that to go below the 40% of the nominal water flow rate does not give any benefits on the pumping energy. The power input of the pumps has cubic relation with the pump speed and so with the water flow rate.

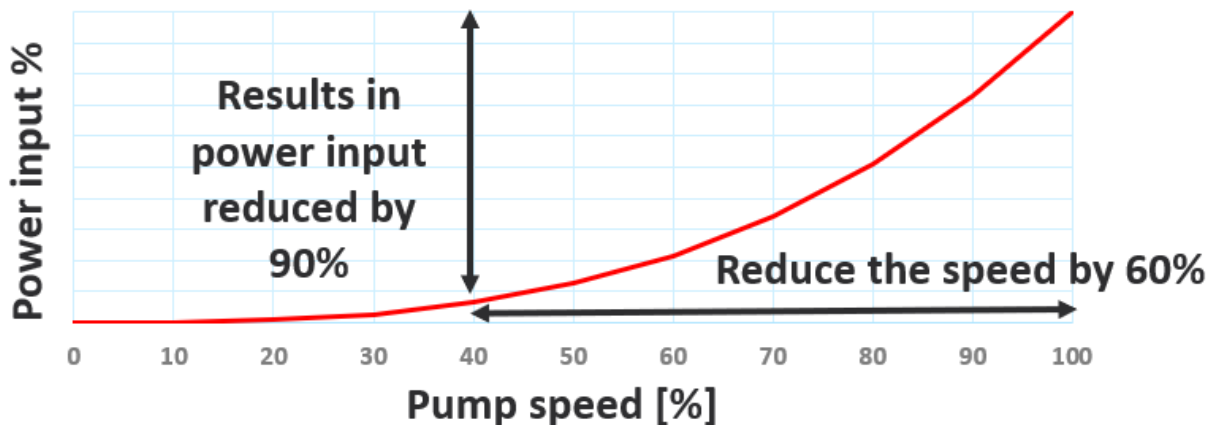

For each model please, refer to minimum water flow rate indicate din technical specifications tables.

**Operating limits for Storage** Environmental conditions must be within the following limits:

- Minimum ambient temperature: -20°C
- Maximum ambient temperature: 57°C
- Maximum R.H.: 95% not condensing

Storage below the minimum temperature may cause damage to components. Storage above the maximum temperature causes opening of safety valves.

Storage in condensing atmosphere may damage electronic components.

**Water treatment** Before putting the unit into operation, clean the water circuit. Dirt, scales, corrosion debits and other material can accumulate inside the heat exchanger and reduce its heat exchanging capacity. Pressure drop can increase as well, thus reducing water flow. Proper water treatment therefore reduces the risk of corrosion, erosion, scaling, etc. The most appropriate water treatment must be determined locally, according to the type of system and water characteristics. The manufacturer is not responsible for damage to or malfunctioning of equipment caused by failure to treat water or by improperly treated water.

**ACCEPTABLE WATER QUALITY LIMITS**

· PH (25°C)	6.8 -8.0
· Electrical conductivity (µS/cm) (25°C)	< 800
· Chloride ion (mg Cl <sup>-</sup> /l)	<150
· Chlorine molecular (mg Cl <sub>2</sub> /l)	<5
· Sulphate ion (mg SO <sub>4</sub> <sup>--</sup> /l)	<100
· Alkalinity (mg CaCO <sub>3</sub> /l)	<100
· Total Hardness (mg CaCO <sub>3</sub> /l)	<200
· Iron (mg Fe/l)	<1.0
· Copper (mg Cu/l)	<1.0
· Sulphide ion (S <sup>--</sup> /l)	none
· Ammonium ion (mg NH <sub>4</sub> <sup>+</sup> /l)	<1.0
· Silica (mg SiO <sub>2</sub> /l)	<50
· Maximum particle size to pass (filtration limit) through heat exchanger (mm)	0.5
· Total dissolved solids (mg/l)	<1500
· Max Ethylene, Propylene glycol	50%

Water-glycol mixture with the passing of time decays and it gives rise to acid products that can start corrosion processes. Also, the degradation of products in the water-glycol mixture may allow biological proliferation and thus bacteria formation can give rise to corrosion. For these reasons' glycol has to be used with suitable corrosion inhibitors.

The corrosion inhibitors have a lifespan (1 or 2 years) so it is important to periodically verify the percentage of the water-glycol mixture

Inhibitors may become insufficient due to "top ups" of water in the circuit (if water is added to the mixture due to low level, the percentage of glycol must remain as per requirements therefore the correct % of glycol should also be integrated.

The parameters to be checked regularly are the antifreeze concentration and the pH of water-glycol mixture

**Heat recovery** Units may be optionally equipped with heat recovery system. This system is made by a water-cooled heat exchanger located on the compressors discharge pipe and a dedicated management of condensing pressure. There is a plate to plate heat exchanger for each circuit. Check on unit drawing the position of Heat recovery heat exchangers.

The heat recovery exchangers are not manifolded on water side. All hydraulic connection must be done on job site. The water connections of recovery exchangers are threaded. Check on unit drawing for the size of the connection.

Is strongly recommended to install a 3-ways valve on the heat recovery loop. The valve, not provided by factory, acts as a mixing valve, managed by the unit controller based on the temperature of the water entering the heat exchangers avoiding excessively cold water to enters.

This to ensure that the compressor operate within allowed temperatures range. Minimum water temperature to ensure proper chiller operation is 25°C.

NOTE: It is a responsibility of plant designer and chiller installer to guarantee the respect of this value by using the recirculating bypass valve or other systems.

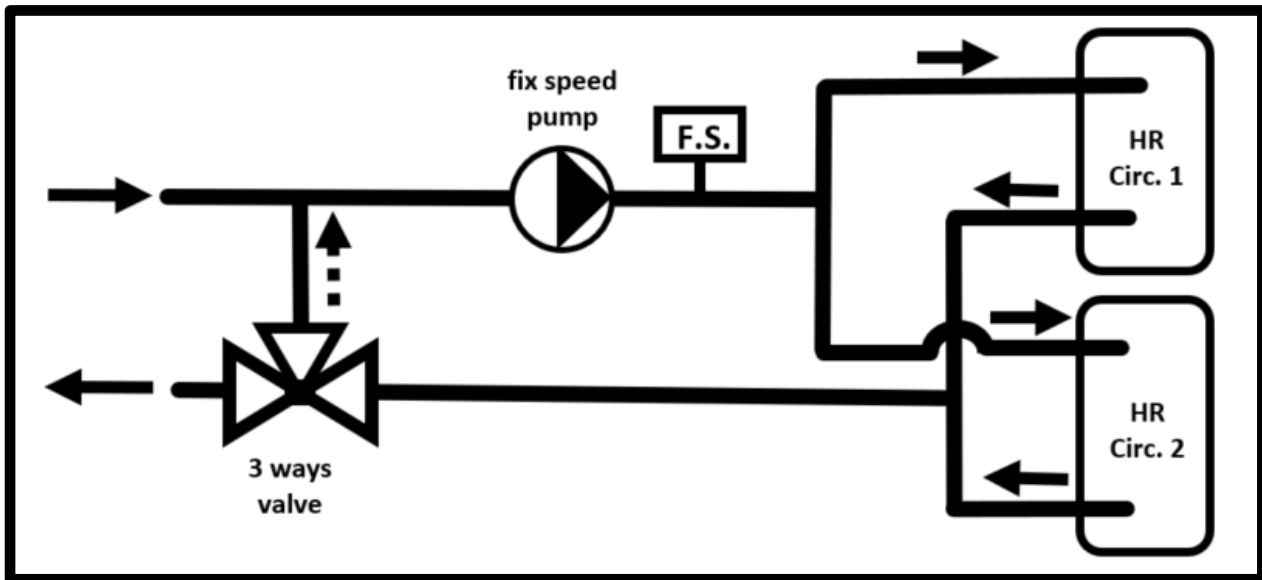

The flow switch must be installed on the heat recovery water loop. Pump, valve, flow switch and manifold are not provided by the factory.

In case of fix water flow rate on heat recovery loop the outlet temperature from the heat recovery exchanger decrease with unit load.

The chiller follows the load on the cold loop and the heating capacity is always the result of the cooling operation. The capacity of the compressors is regulated on the Evaporating Leaving Water Temperature (ELWT). In part load operation the Evaporator Entering Water Temperature (EEWT) decreases.

With the unit is set on "Heat Recovery ON" the unit controller activates the circulating pump on the heating loop and start to check on the water entering the heat recovery exchangers (CEWT). If the CEWT is below the set point the unit starts to produce hot water.

The relation between the load of the compressors and the delta-T on the heat recovery exchanger (CLWT-CEWT) is can be approximated as linear.

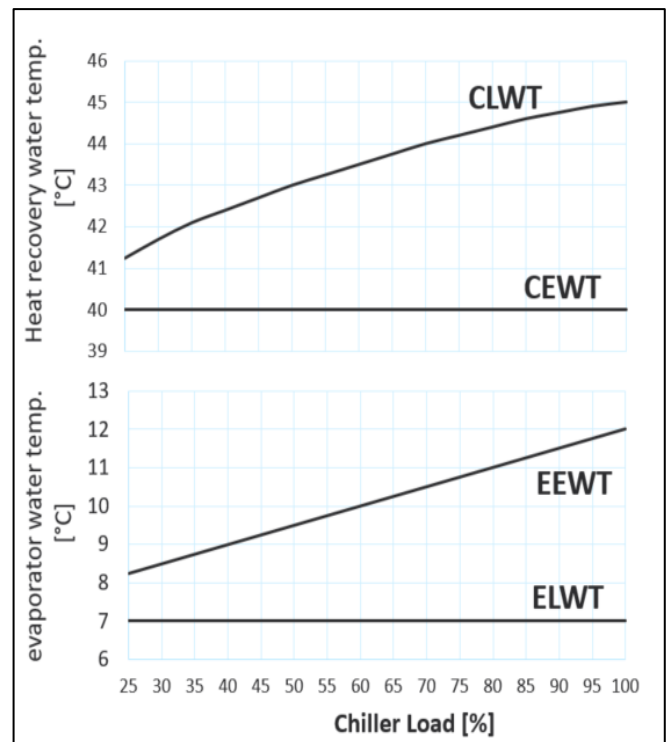

Is possible to operate with variable flow rate on heat recovery. The control for the pump speed (not provided by the factory) can be done to keep constant the delta-T on heat recovery loop.  
 In this case isolating valve must be installed on each heat recovery exchanger to avoid that water passes through a heat recovery exchanger while the related compressor is OFF. The state of the isolating valve must be linked to the state of the compressor.

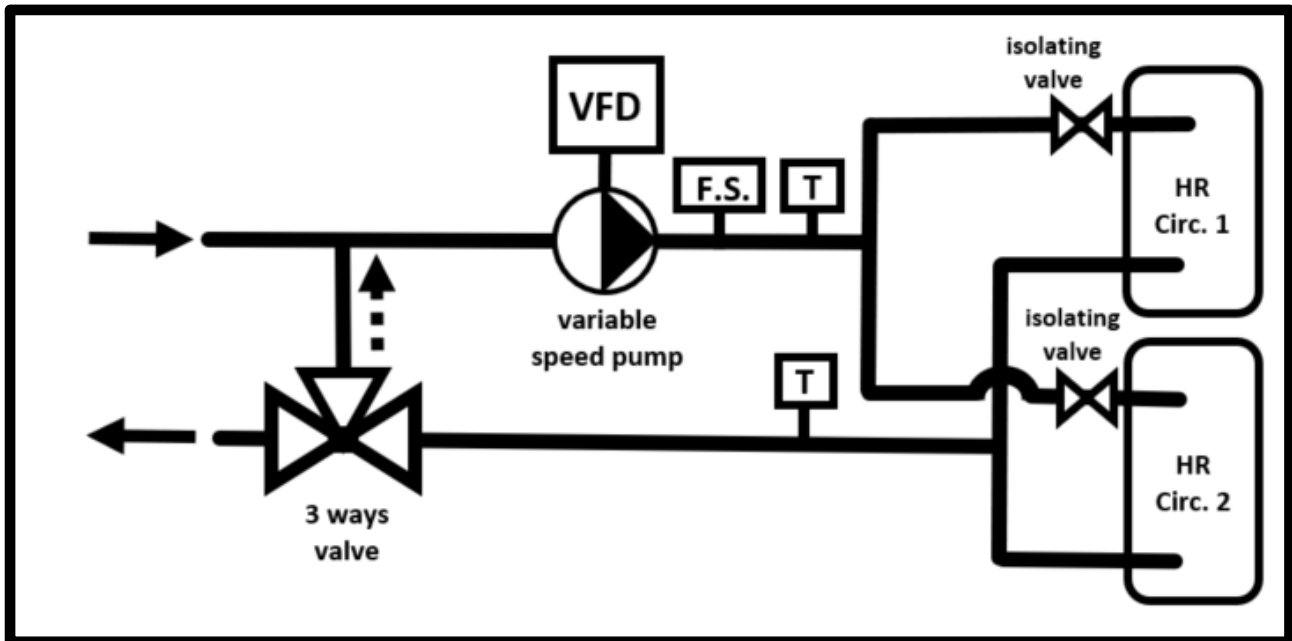

NOTE: flow switch must be set to detect the minim flow for the circuit.

**Heat recovery exchanger - water content**

series	model	THR - water volume [lt]
EWAH~TZ S-S/L/R C	710	22,3
	770	22,3
	880	30,4
	940	30,4
	990	30,4
	H10	30,4
	C11	36,5
	C12	36,5
	C13	40,5
	C14	40,5
EWAH~TZ X-S/L/R C	670	22,3
	780	26,3
	840	30,4
	950	30,4
	C10	30,4
	C11	36,5
	C12	36,5
	C13	40,5
	C14	40,5
	C15	40,5

series	model	THR - water volume [lt]
EWAD~TZ S-S/L/R C	H11	36,5
	H12	40,5
	H13	40,5
	C15	40,5
	C16	40,5
	H17	not available
	H18	not available
	H19	not available
	EWAD~TZ X-S/R C	C11
C12		36,5
H12		40,5
C14		40,5
C15		40,5
H16		40,5
H17		not available

NOTE: the above value s can change without notice.

In case of customized unit, the data may differ form the standard. Contact factory for data related customized units

Hydronic kit – optional

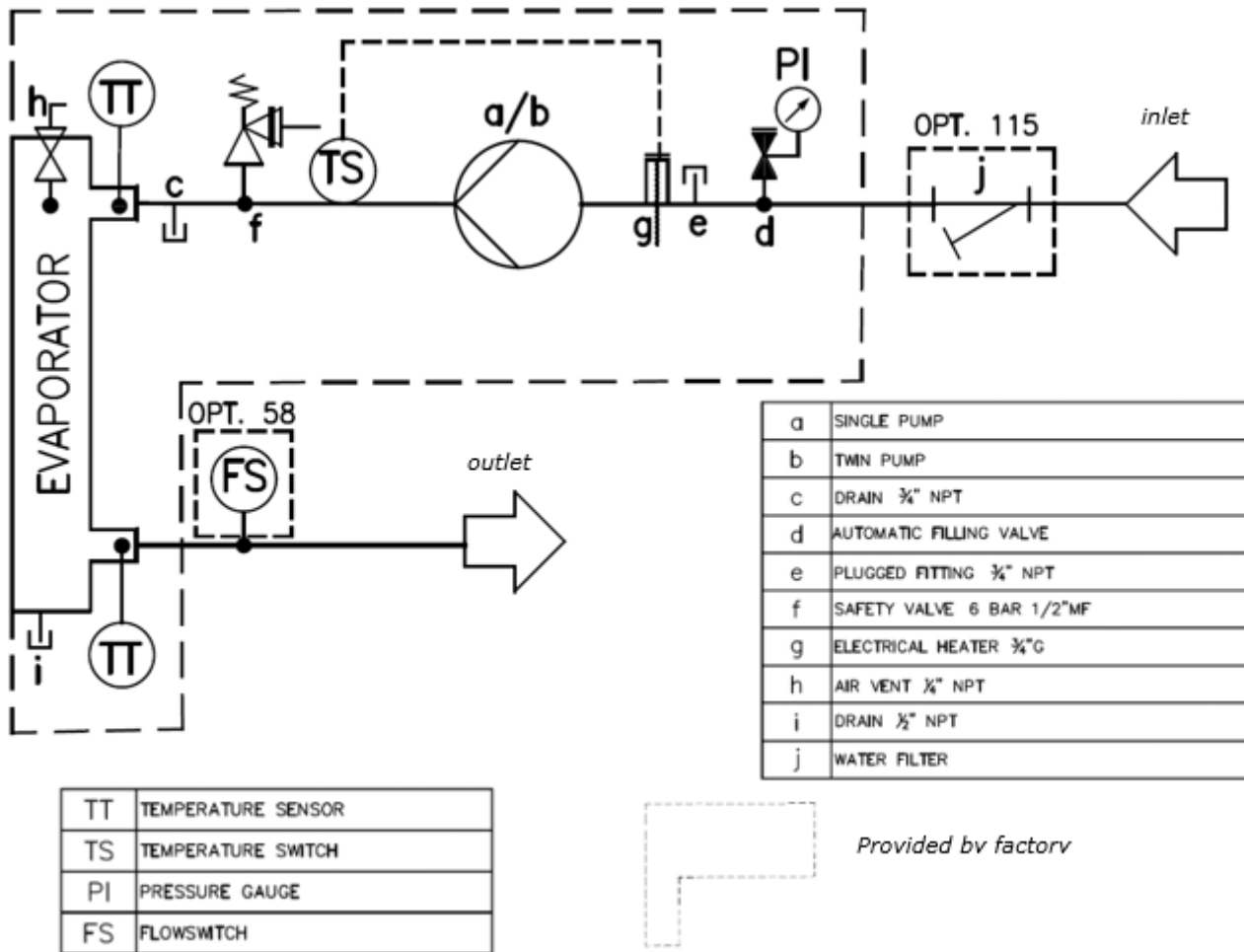

Configuration of the hydronic kit with **pump pushing** fluid in the evaporator:

	Model single pump		Model double pump	
	Low lift	High lift	Low lift	High lift
SILVER VERSION (Unit with R1234ze)	EWAH710TZSSC2		EWAH710TZSSC2	
	EWAH770TZSSC2		EWAH770TZSSC2	
	EWAH880TZSSC2		EWAH880TZSSC2	
	EWAH940TZSSC2		EWAH940TZSSC2	
	EWAH990TZSSC2		EWAH990TZSSC2	
GOLD VERSION (Unit with R1234ze)	EWAH670TZXSC2		EWAH670TZXSC2	
	EWAH780TZXSC2		EWAH780TZXSC2	
	EWAH840TZXSC2		EWAH840TZXSC2	

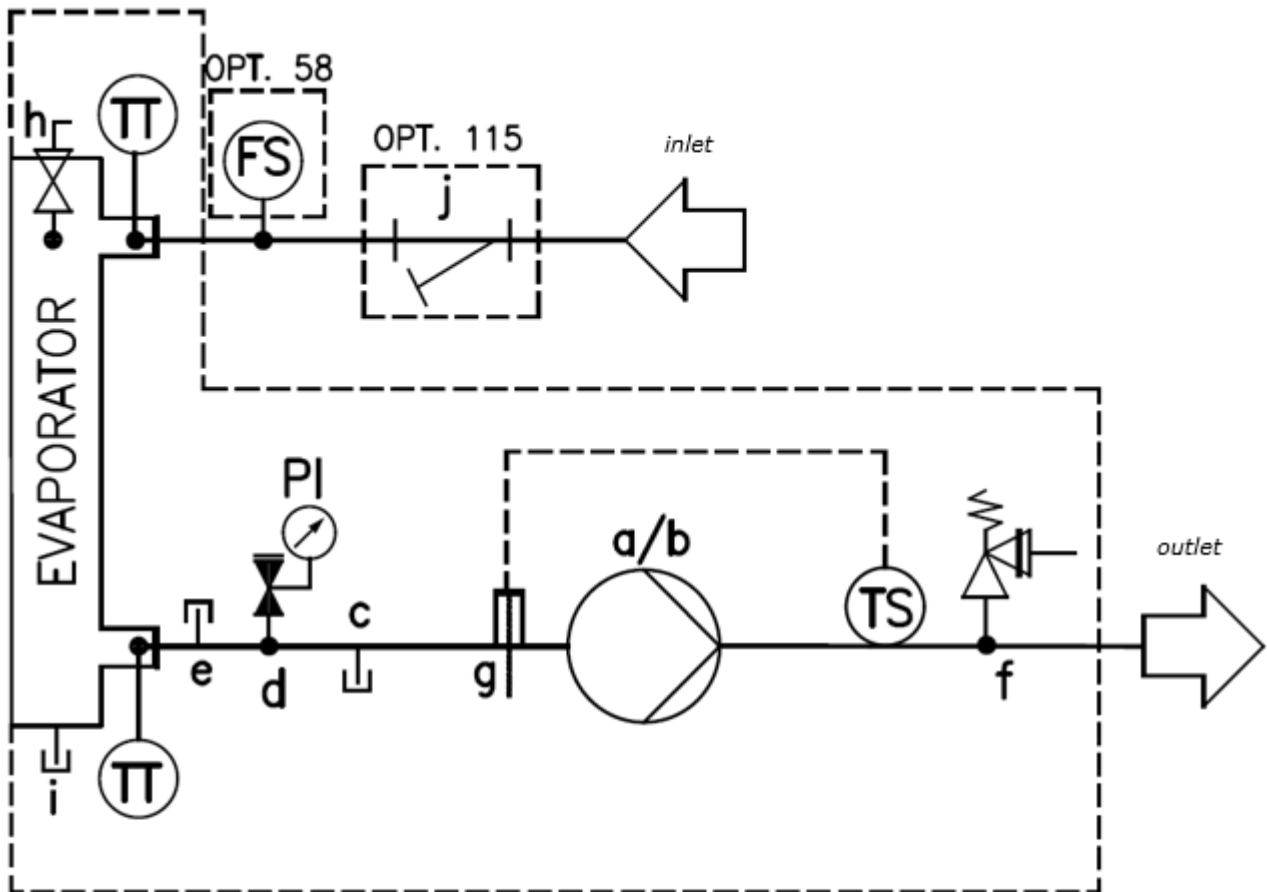

a	SINGLE PUMP
b	TWIN PUMP
c	DRAIN 3/8" NPT
d	AUTOMATIC FILLING VALVE
e	PLUGGED FITTING 3/8" NPT
f	SAFETY VALVE 6 BAR 1/2"MF
g	ELECTRICAL HEATER 3/4"G
h	AIR VENT 1/8" NPT
i	DRAIN 1/2" NPT
j	WATER FILTER

TT	TEMPERATURE SENSOR
TS	TEMPERATURE SWITCH
PI	PRESSURE GAUGE
FS	FLOWSWITCH

*Provided by factory*

Configuration of the hydronic kit with **suction pump** from the evaporator:

	Model single pump		Model double pump	
	Low lift	High lift	Low lift	High lift
SILVER VERSION (Unit with R1234ze)	EWAHH10TZSSC2		EWAHH10TZSSC2	
	EWAHC11TZSSC2		EWAHC11TZSSC2	
	EWAHC12TZSSC2		EWAHC12TZSSC2	
	EWAHC13TZSSC2		EWAHC13TZSSC2	
	EWAHC14TZSSC2		EWAHC14TZSSC2	
	EWAHC15TZSSC2		EWAHC15TZSSC2	
GOLD VERSION (Unit with R1234ze)	EWAH950TZXSC2		EWAH950TZXSC2	
	EWAHC10TZXSC2		EWAHC10TZXSC2	
	EWAHC11TZXSC2		EWAHC11TZXSC2	
	EWAHC12TZXSC2		EWAHC12TZXSC2	
	EWAHC13TZXSC2		EWAHC13TZXSC2	
EWAHC14TZXSC2		EWAHC14TZXSC2		

	Model single pump		Model double pump	
	Low lift	High lift	Low lift	High lift
SILVER VERSION (Unit with R134a)	EWADH11TZSSC2		EWADH11TZSSC2	
	EWADH12TZSSC2		EWADH12TZSSC2	
	EWADH13TZSSC2		EWADH13TZSSC2	
	EWADC15TZSSC2		EWADC15TZSSC2	
GOLD VERSION (Unit with R134a)	EWADC11TZXSC2		EWADC11TZXSC2	
	EWADC12TZXSC2		EWADC12TZXSC2	
	EWADH12TZXSC2		EWADH12TZXSC2	
	EWADC14TZXSC2		EWADC14TZXSC2	

		Model single pump		Model double pump	
		Low lift	High lift	Low lift	High lift
(Silver unit with R1234ze)	EWAHC16TZSSC2	N.A.	N.A.	N.A.	N.A.
(Gold unit with R1234ze)	EWAHC15TZXSC2				
(Silver units with R134a)	EWADC16TZSSC2				
	EWADH17TZSSC2				
	EWADH18TZSSC2				
	EWADH19TZSSC2				
(Gold units with R134a)	EWADC15TZXSC2				
	EWADH16TZXSC2				
	EWADH17TZXSC2				

EWAH~TZ S S/L/R C-

Single pump – Low lift

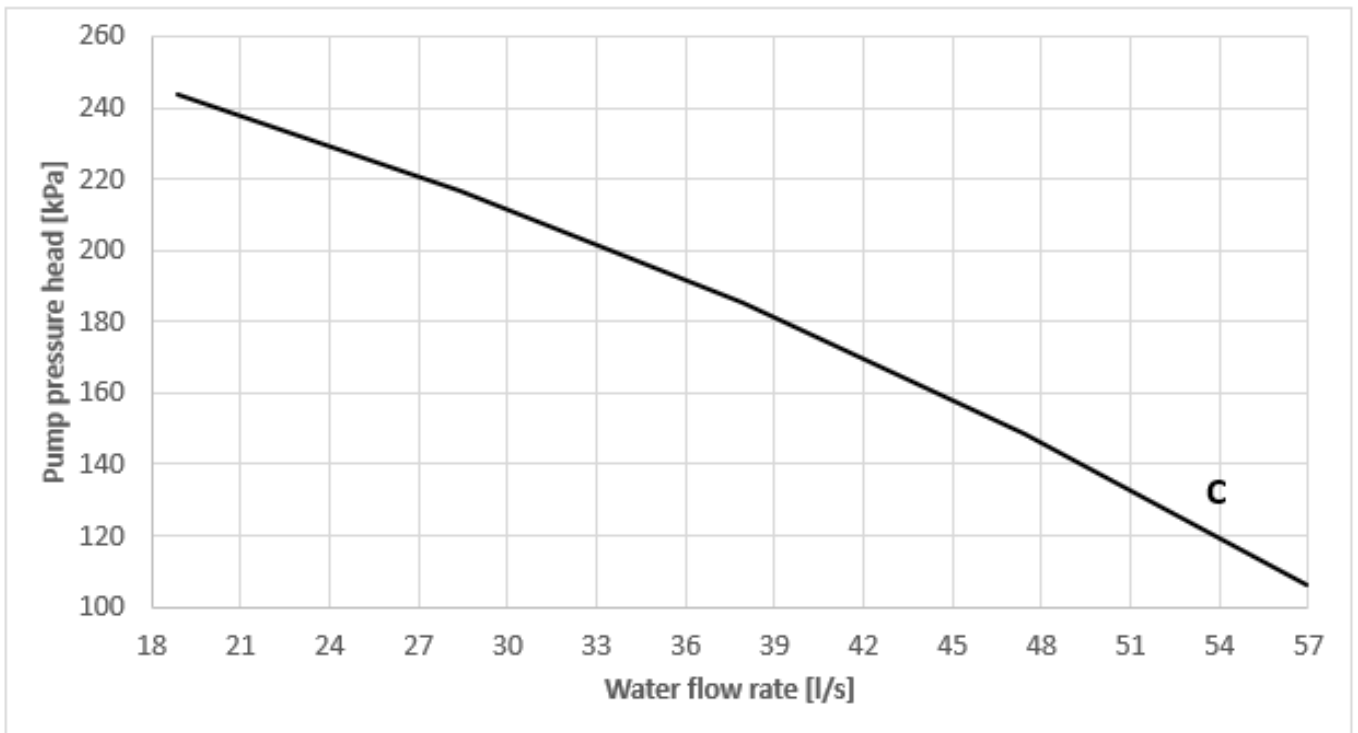
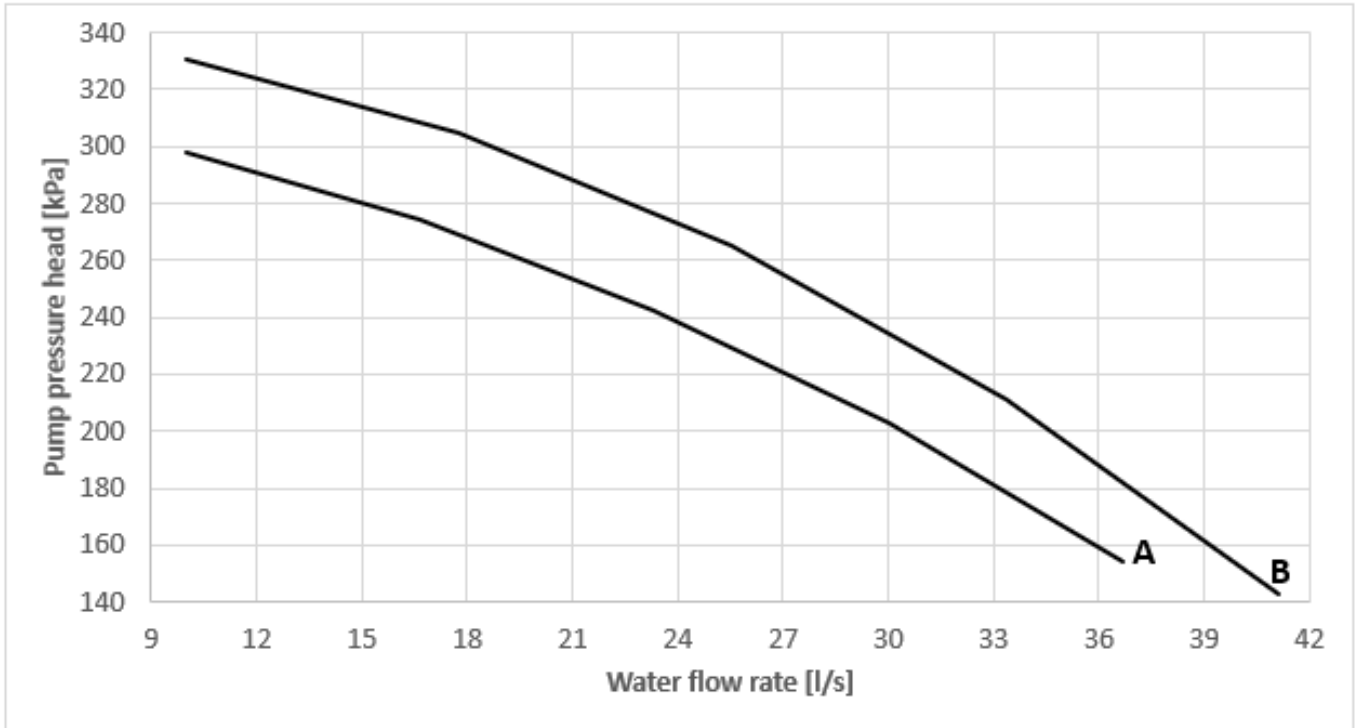



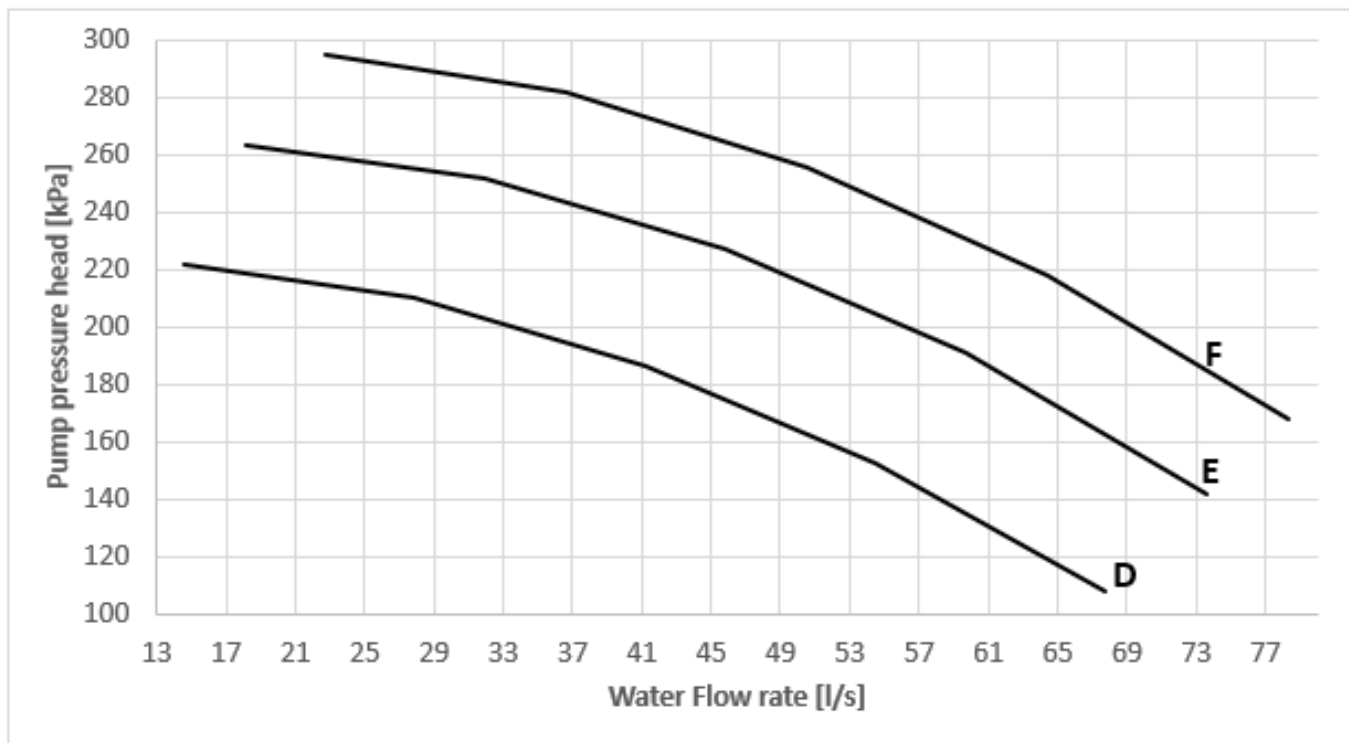

**EWAH~TZ S- C / R1234ze - Single Pump Low Lift**

models	ref. curve	Pump motor power input	Pump motor current (5)	Power supply	PN	Motor protection	Insulation class	Water flow rate (1)	Evaporator pressure drop (1)	Filter pressure drop (2)	Pump water head @ std condition (3)	Available water head @ std condition (1) (4)
		kW	A	V – ph. – Hz	-	-	-	l/s	kPa	kPa	kPa	KPa
710	A	9,2	20,2	400 - 3 - 50	10	IP55	F	34	45	7	175	123
770	B	11	20,2	400 - 3 - 50	10	IP55	F	36,5	51	8	185	126
880	C	11	20,2	400 - 3 - 50	10	IP55	F	41,9	60	6	170	104
940	C	11	20,2	400 - 3 - 50	10	IP55	F	45	68	7	158	83
990	C	11	20,2	400 - 3 - 50	10	IP55	F	47,2	60	8	149	81
H10	D	11	26,6	400 - 3 - 50	10	IP55	F	50,3	67	9	164	88
C11	E	15	26,6	400 - 3 - 50	10	IP55	F	53,3	44	3	209	162
C12	E	18,5	32,7	400 - 3 - 50	10	IP55	F	58,7	53	3	194	138
C13	E	18,5	32,7	400 - 3 - 50	10	IP55	F	62,1	39	4	183	141
C14	E	18,5	32,7	400 - 3 - 50	10	IP55	F	68,3	46	5	162	111
C15	F	18,5	32,7	400 - 3 - 50	10	IP55	F	72,4	51	5	190	134
C16	N.A.	N.A.	N.A.	N.A.	N.A.	N.A.	N.A.	N.A.	N.A.	N.A.	N.A.	N.A.

- (1) Standard Rating Conditions for Air to water chillers according to EN14511:2 Outdoor Heat exchanger inlet dry bulb temperature 35°; Indoor heat exchanger inlet water temperature 12°C, outlet water temperature 7°C.
- (2) The pressure drops for the filter are referred to the one provided by DAIKIN as option (option code 115). In case of filter provided by third party supplier the pressure drop in the table must not be considered.
- (3) Total head of the pump.
- (4) Available head external to the unit (already including the pressure drop in the exchanger and in the filter (if opt 115 is selected)
- (5) Refer to 400 V power supply

The above data are referred to the unit without additional optional.  
 In case of unit with opt. 08, 154, 187 refer the selection sheet for the actual pressure drops.  
 The above data are referred the unit installed in compliancy with installation prescription.  
 All the data are subject to change without notice. For updated information on project base refer to Chiller Selection Software and unit nameplate.

EWAH~TZ S S/L/R C-

Single pump – High lift

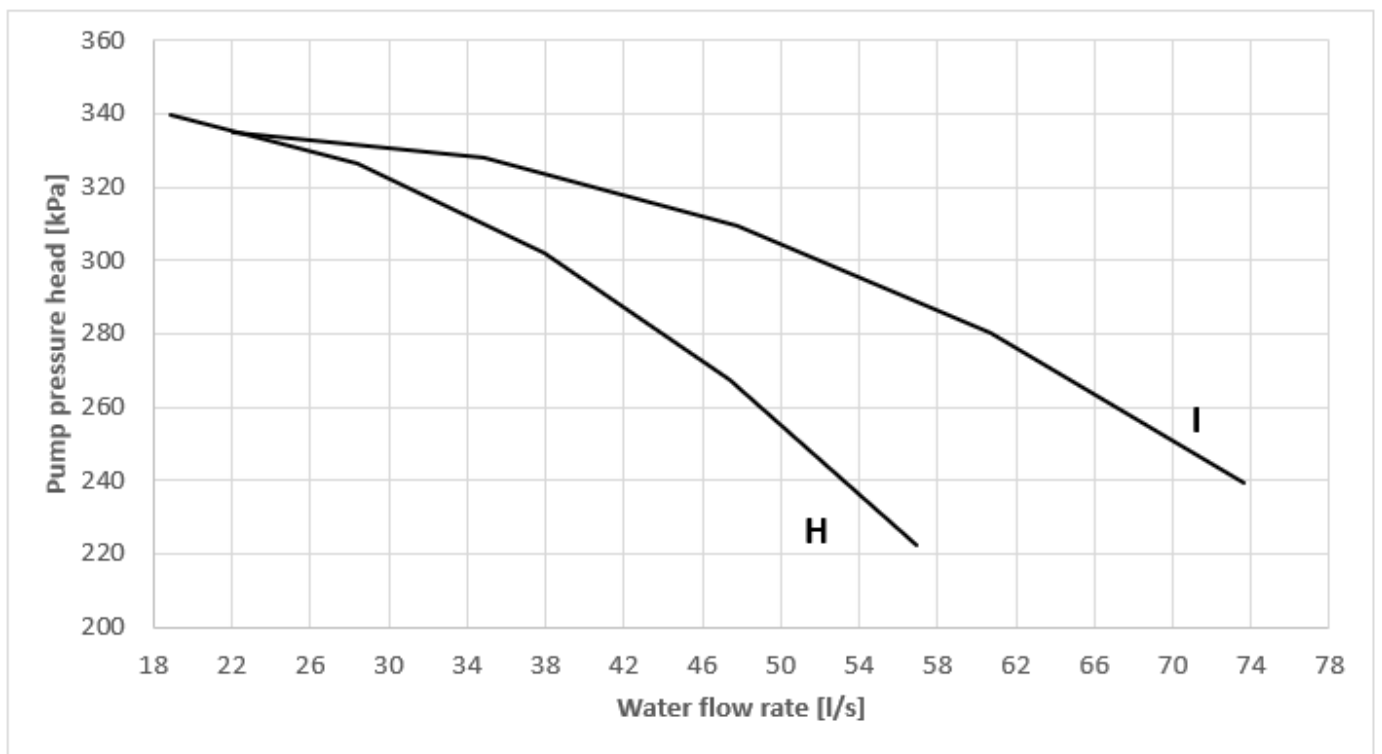
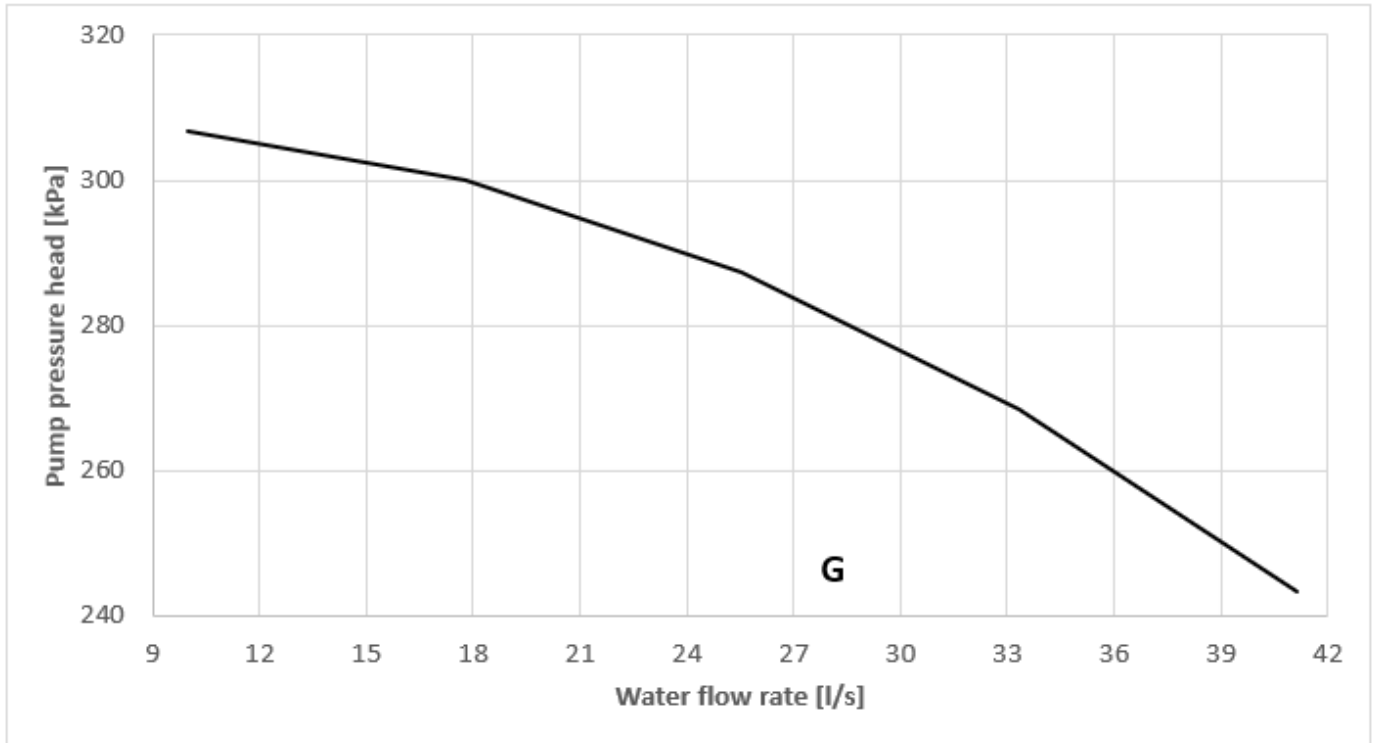

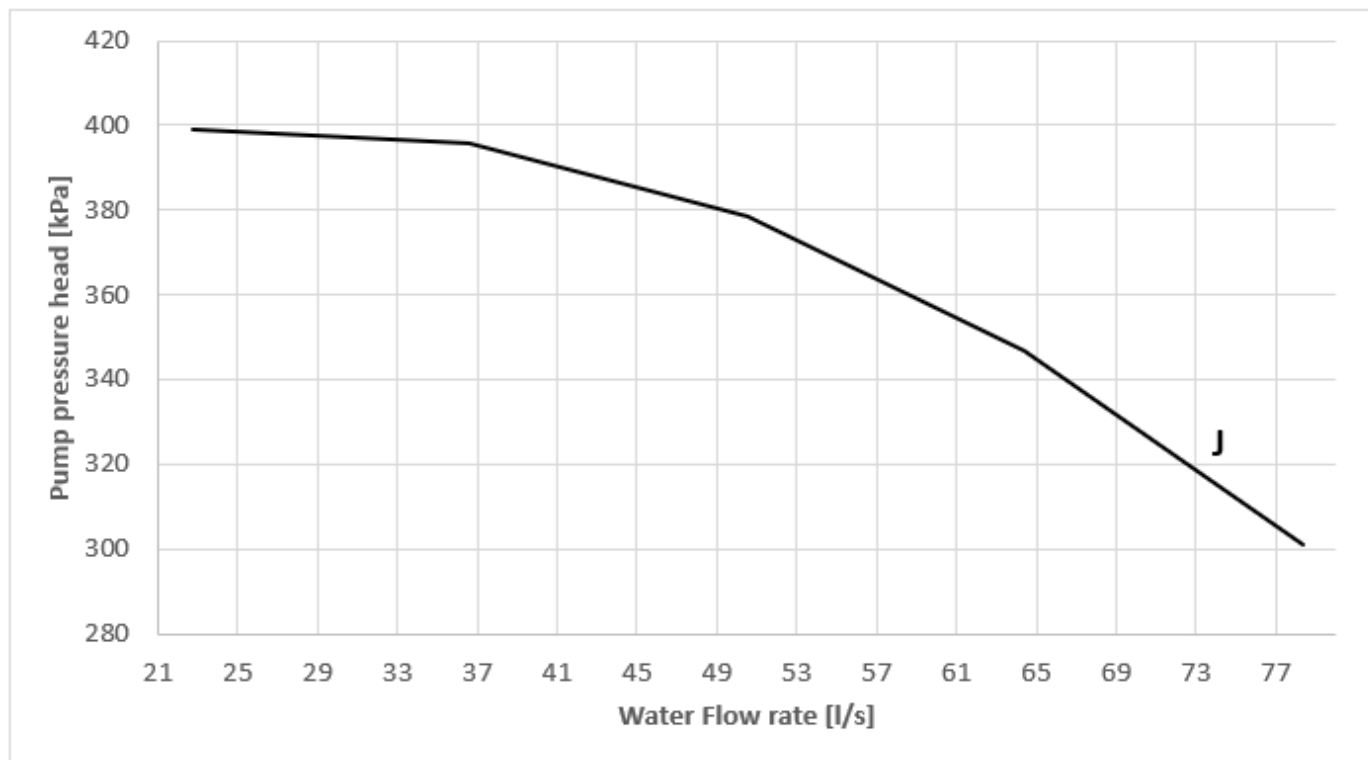

**EWAH~TZ S- C / R1234ze - Single Pump High Lift**

models	ref. curve	Pump motor power input	Pump motor current (5)	Power supply	PN	Motor protection	Insulation class	Water flow rate (1)	Evaporator pressure drop (1)	Filter pressure drop (2)	Pump water head @ std condition (3)	Available water head @ std condition (1) (4)
		kW	A									
710	G	15	26,6	400 - 3 - 50	10	IP55	F	34	45	7	266	215
770	G	15	26,6	400 - 3 - 50	10	IP55	F	36,5	51	8	259	200
880	H	18,5	32,7	400 - 3 - 50	10	IP55	F	41,9	60	6	289	223
940	H	18,5	32,7	400 - 3 - 50	10	IP55	F	45	68	7	277	202
990	H	18,5	32,7	400 - 3 - 50	10	IP55	F	47,2	60	8	268	201
H10	I	22	42,2	400 - 3 - 50	10	IP55	F	50,3	67	9	305	229
C11	I	22	42,2	400 - 3 - 50	10	IP55	F	53,3	44	3	298	251
C12	J	22	42,2	400 - 3 - 50	10	IP55	F	58,7	53	3	285	229
C13	J	22	42,2	400 - 3 - 50	10	IP55	F	62,1	39	4	276	234
C14	J	22	42,2	400 - 3 - 50	10	IP55	F	68,3	46	5	258	207
C15	J	30	52,7	400 - 3 - 50	10	IP55	F	72,4	51	5	322	266
C16	N.A.	N.A.	N.A.	N.A.	N.A.	N.A.	N.A.	N.A.	N.A.	N.A.	N.A.	N.A.

- (1) Standard Rating Conditions for Air to water chillers according to EN14511:2 Outdoor Heat exchanger inlet dry bulb temperature 35°; Indoor heat exchanger inlet water temperature 12°C, outlet water temperature 7°C.
- (2) The pressure drops for the filter are referred to the one provided by DAIKIN as option (option code 115). In case of filter provided by third party supplier the pressure drop in the table must not be considered.
- (3) Total head of the pump.
- (4) Available head external to the unit (already including the pressure drop in the exchanger and in the filter (if opt 115 is selected)
- (5) Refer to 400 V power supply

The above data are referred to the unit without additional optional.  
 In case of unit with opt. 08, 154, 187 refer the selection sheet for the actual pressure drops.  
 The above data are referred the unit installed in compliancy with installation prescription.  
 All the data are subject to change without notice. For updated information on project base refer to Chiller Selection Software and unit nameplate.

EWAH~TZ S S/L/R C-

Dual pump – Low lift

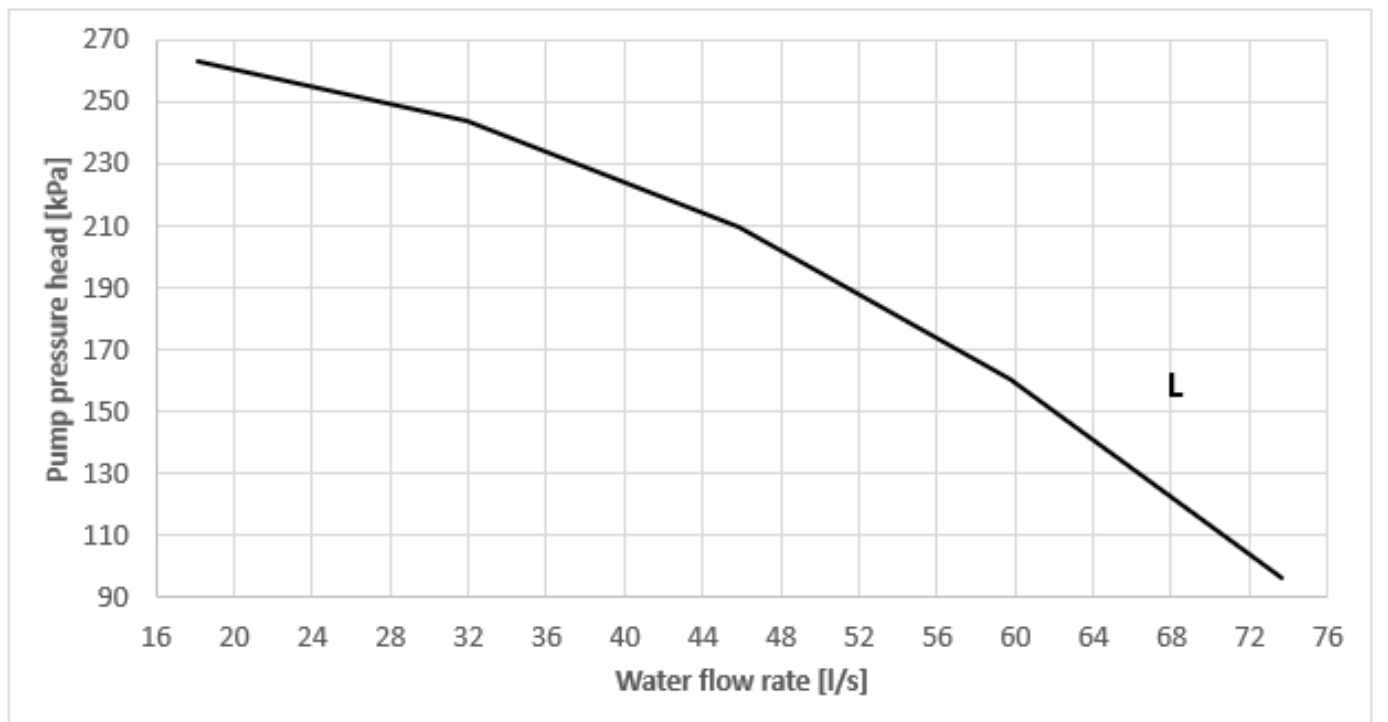
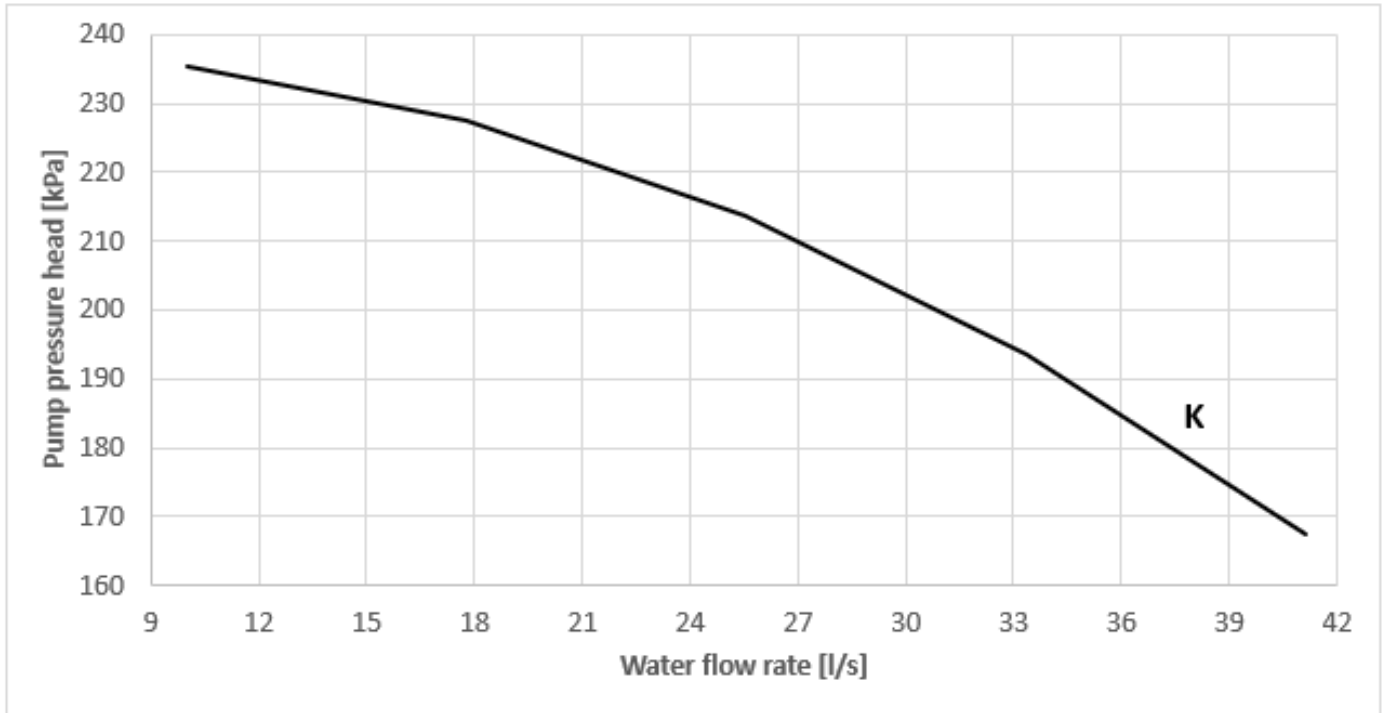

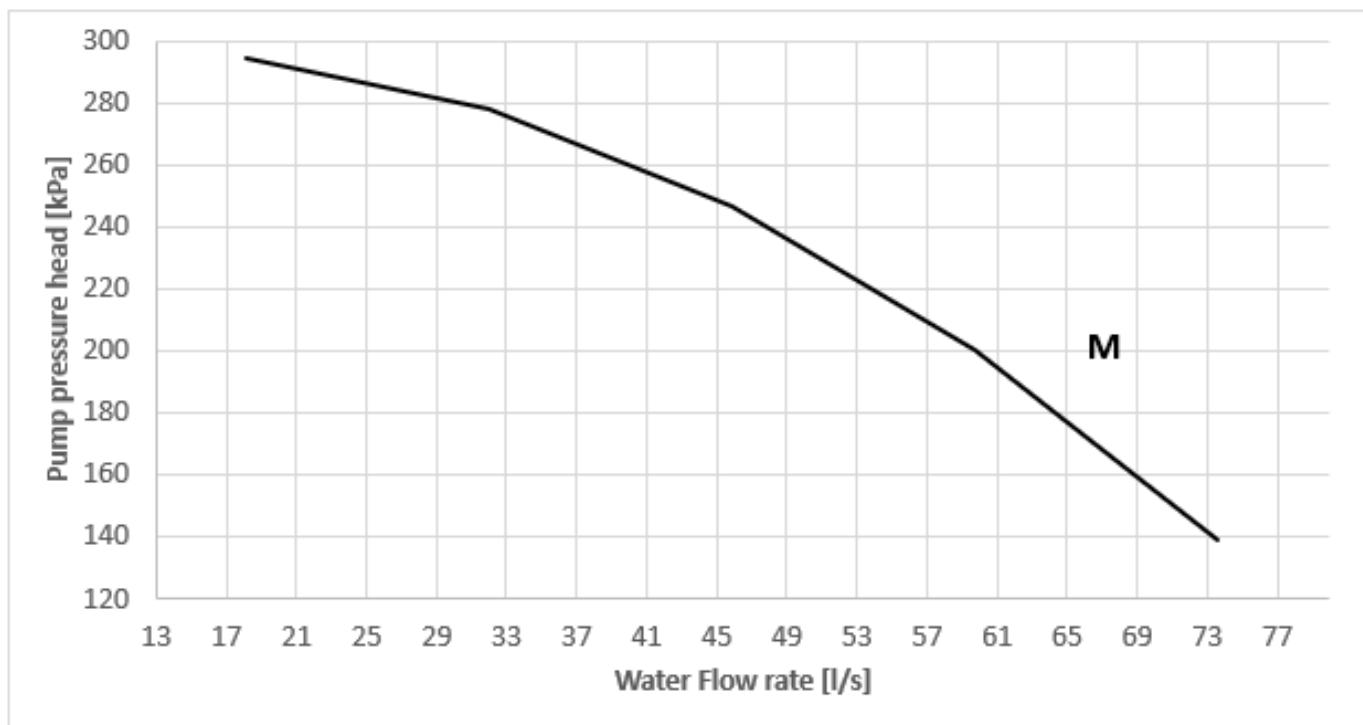

**EWAH~TZ S- C / R1234ze - Dual Pump Low Lift**

models	ref. curve	Pump motor power input	Pump motor current (5)	Power supply	PN	Motor protection	Insulation class	Water flow rate (1)	Evaporator pressure drop (1)	Filter pressure drop (2)	Pump water head @ std condition (3)	Available water head @ std condition (1) (4)
		kW	A	V – ph. – Hz	-	-	-	l/s	kPa	kPa	kPa	KPa
710	K	11	20,2	400 - 3 - 50	10	IP55	F	34	45	7	192	140
770	K	11	20,2	400 - 3 - 50	10	IP55	F	36,5	51	8	184	125
880	K	11	20,2	400 - 3 - 50	10	IP55	F	41,9	60	6	164	98
940	K	11	20,2	400 - 3 - 50	10	IP55	F	45	68	7	152	77
990	K	11	20,2	400 - 3 - 50	10	IP55	F	47,2	60	8	142	75
H10	L	15	26,6	400 - 3 - 50	10	IP55	F	50,3	67	9	196	119
C11	L	15	26,6	400 - 3 - 50	10	IP55	F	53,3	44	3	185	138
C12	M	18,5	32,7	400 - 3 - 50	10	IP55	F	58,7	53	3	204	148
C13	M	18,5	32,7	400 - 3 - 50	10	IP55	F	62,1	39	4	191	148
C14	M	18,5	32,7	400 - 3 - 50	10	IP55	F	68,3	46	5	164	114
C15	M	18,5	32,7	400 - 3 - 50	10	IP55	F	72,4	51	5	145	89
C16	N.A.	N.A.	N.A.	N.A.	N.A.	N.A.	N.A.	N.A.	N.A.	N.A.	N.A.	N.A.

- (1) Standard Rating Conditions for Air to water chillers according to EN14511:2 Outdoor Heat exchanger inlet dry bulb temperature 35°; Indoor heat exchanger inlet water temperature 12°C, outlet water temperature 7°C.
- (2) The pressure drops for the filter are referred to the one provided by DAIKIN as option (option code 115). In case of filter provided by third party supplier the pressure drop in the table must not be considered.
- (3) Total head of the pump.
- (4) Available head external to the unit (already including the pressure drop in the exchanger and in the filter (if opt 115 is selected)
- (5) Refer to 400 V power supply

The above data are referred to the unit without additional optional.  
 In case of unit with opt. 08, 154, 187 refer the selection sheet for the actual pressure drops.  
 The above data are referred the unit installed in compliancy with installation prescription.  
 All the data are subject to change without notice. For updated information on project base refer to Chiller Selection Software and unit nameplate.

EWAH~TZ S S/L/R C-

Dual pump - High lift

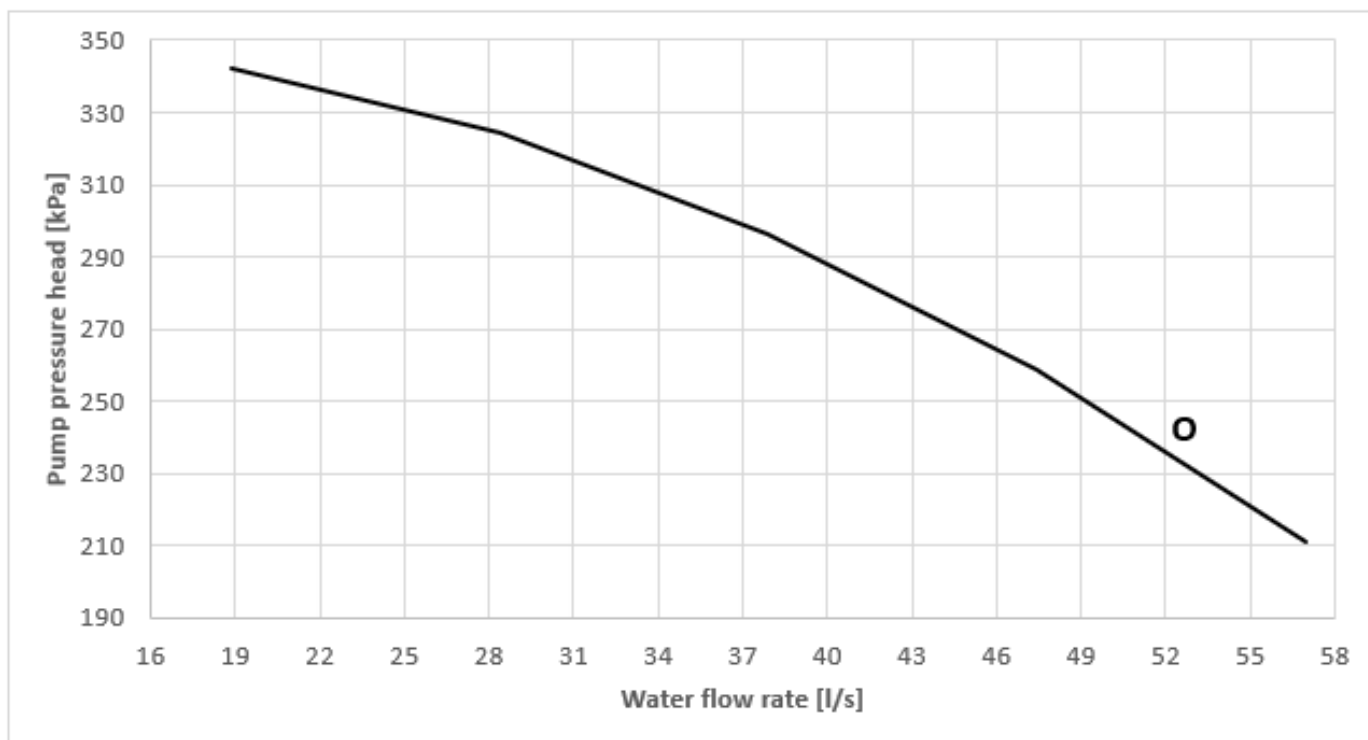
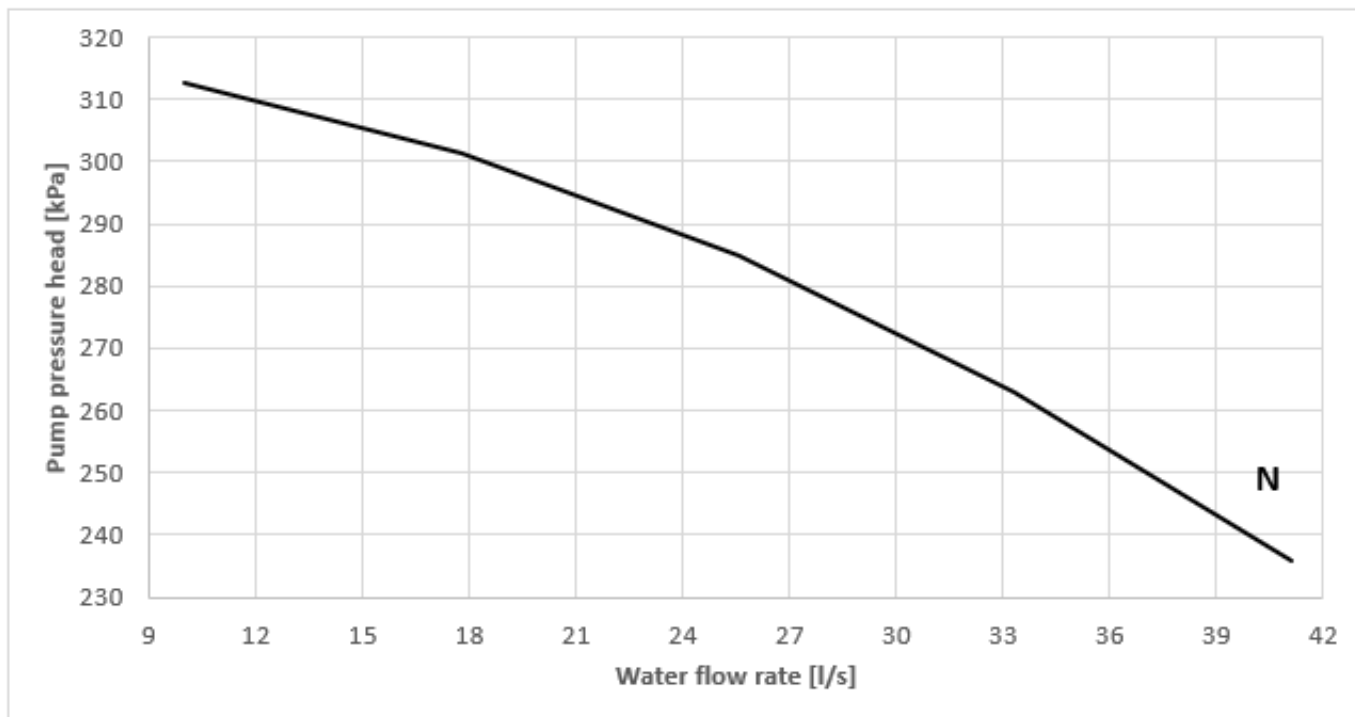

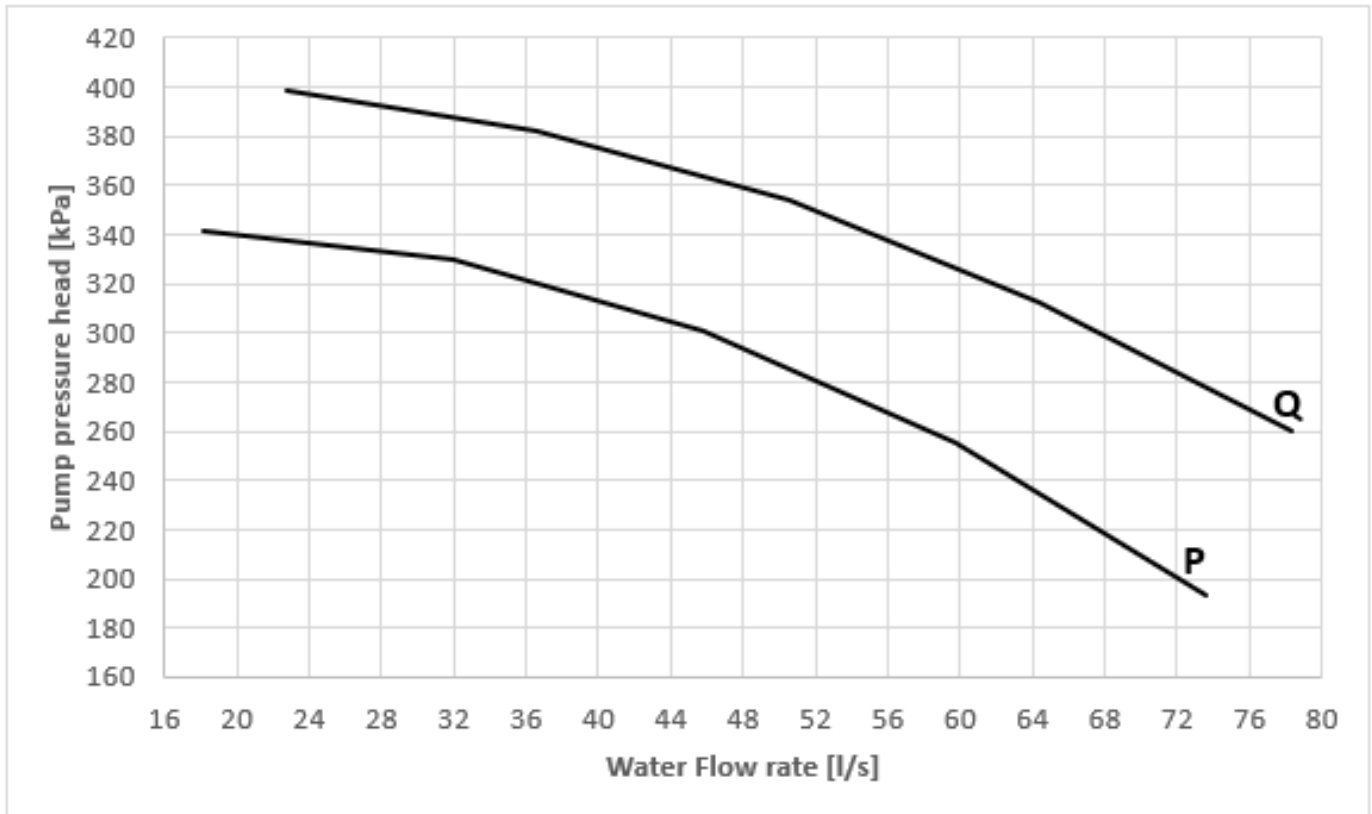

EWAH~TZ S- C / R1234ze - Dual Pump High Lift												
models	ref. curve	Pump motor power input	Pump motor current (5)	Power supply	PN	Motor protection	Insulation class	Water flow rate (1)	Evaporator pressure drop (1)	Filter pressure drop (2)	Pump water head @ std condition (3)	Available water head @ std condition (1) (4)
		kW	A	V – ph. – Hz	-	-	-	l/s	kPa	kPa	kPa	KPa
710	N	15	26,6	400 - 3 - 50	10	IP55	F	34	45	7	261	209
770	N	15	26,5	400 - 3 - 50	10	IP55	F	36,5	51	8	253	194
880	O	18,5	32,7	400 - 3 - 50	10	IP55	F	41,9	60	6	282	216
940	O	18,5	32,7	400 - 3 - 50	10	IP55	F	45	68	7	269	194
990	O	18,5	32,7	400 - 3 - 50	10	IP55	F	47,2	60	8	260	192
H10	P	22	42,2	400 - 3 - 50	10	IP55	F	50,3	67	9	288	212
C11	P	22	42,2	400 - 3 - 50	10	IP55	F	53,3	44	3	278	231
C12	P	22	42,2	400 - 3 - 50	10	IP55	F	58,7	53	3	259	203
C13	P	22	42,2	400 - 3 - 50	10	IP55	F	62,1	39	4	246	203
C14	Q	30	42,2	400 - 3 - 50	10	IP55	F	68,3	46	5	299	249
C15	Q	30	42,2	400 - 3 - 50	10	IP55	F	72,4	51	5	284	228
C16	N.A.	N.A.	N.A.	N.A.	N.A.	N.A.	N.A.	N.A.	N.A.	N.A.	N.A.	N.A.

(1) Standard Rating Conditions for Air to water chillers according to EN14511:2 Outdoor Heat exchanger inlet dry bulb temperature 35°; Indoor heat exchanger inlet water temperature 12°C, outlet water temperature 7°C.  
 (2) The pressure drops for the filter are referred to the one provided by DAIKIN as option (option code 115). In case of filter provided by third party supplier the pressure drop in the table must not be considered.  
 (3) Total head of the pump.  
 (4) Available head external to the unit (already including the pressure drop in the exchanger and in the filter (if opt 115 is selected)  
 (5) Refer to 400 V power supply

The above data are referred to the unit without additional optional.  
 In case of unit with opt. 08, 154, 187 refer the selection sheet for the actual pressure drops.  
 The above data are referred the unit installed in compliancy with installation prescription.  
 All the data are subject to change without notice. For updated information on project base refer to Chiller Selection Software and unit nameplate.

EWAH~TZ X S/L/R C-

Single pump – Low lift

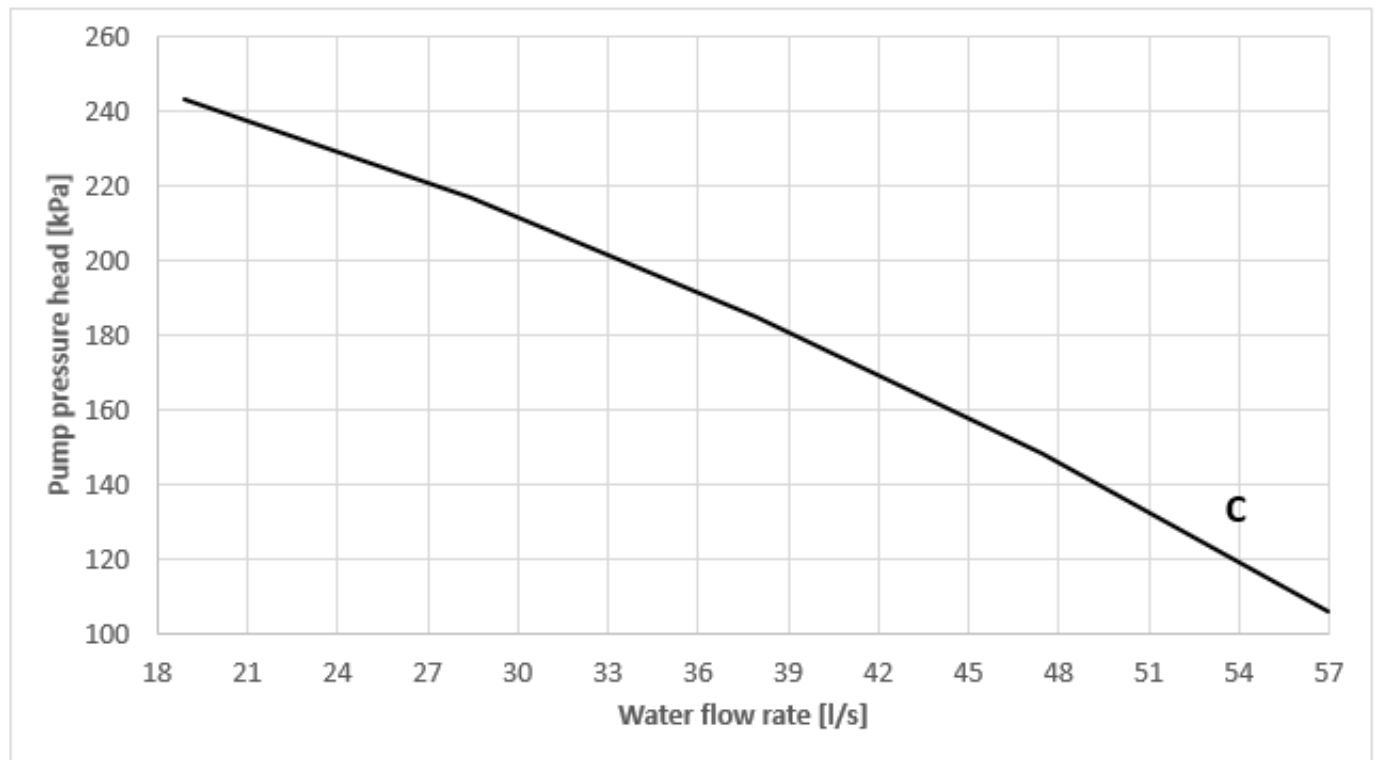
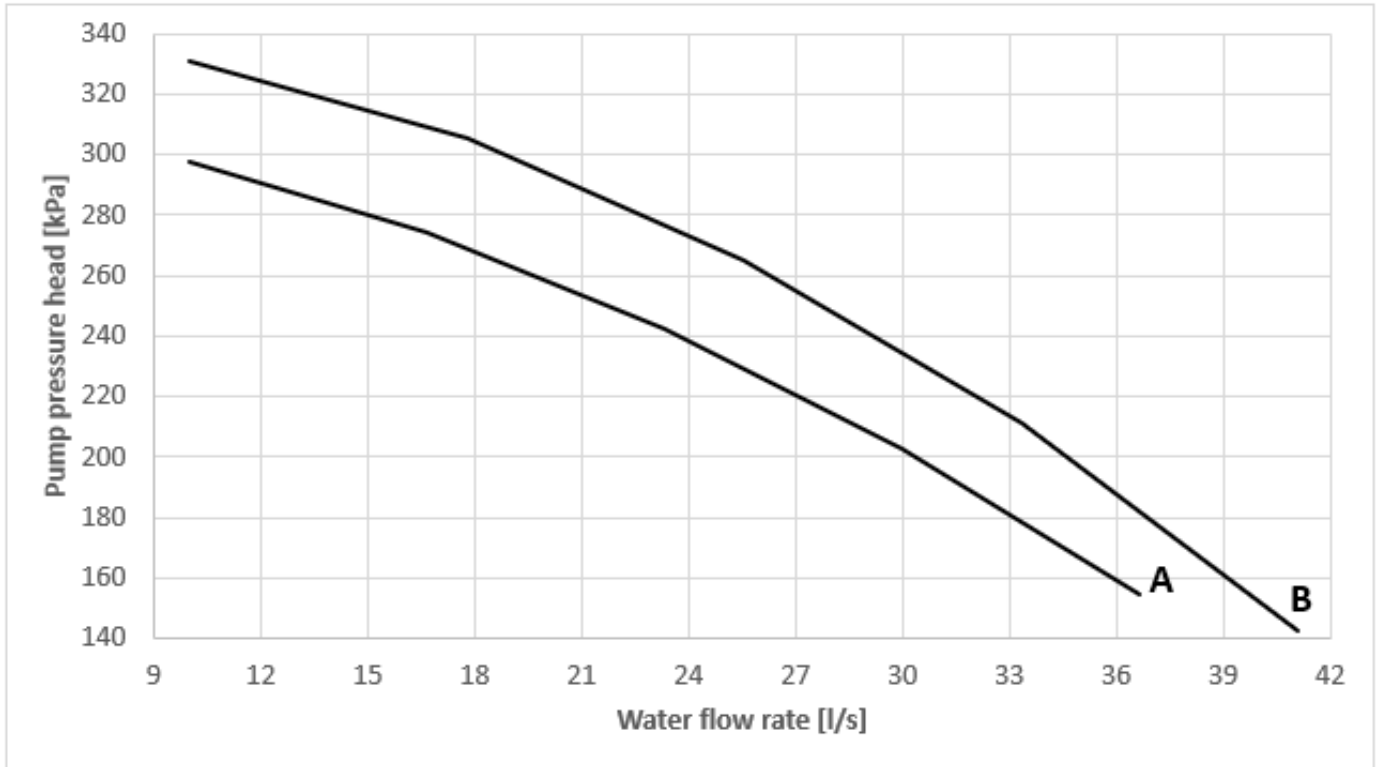



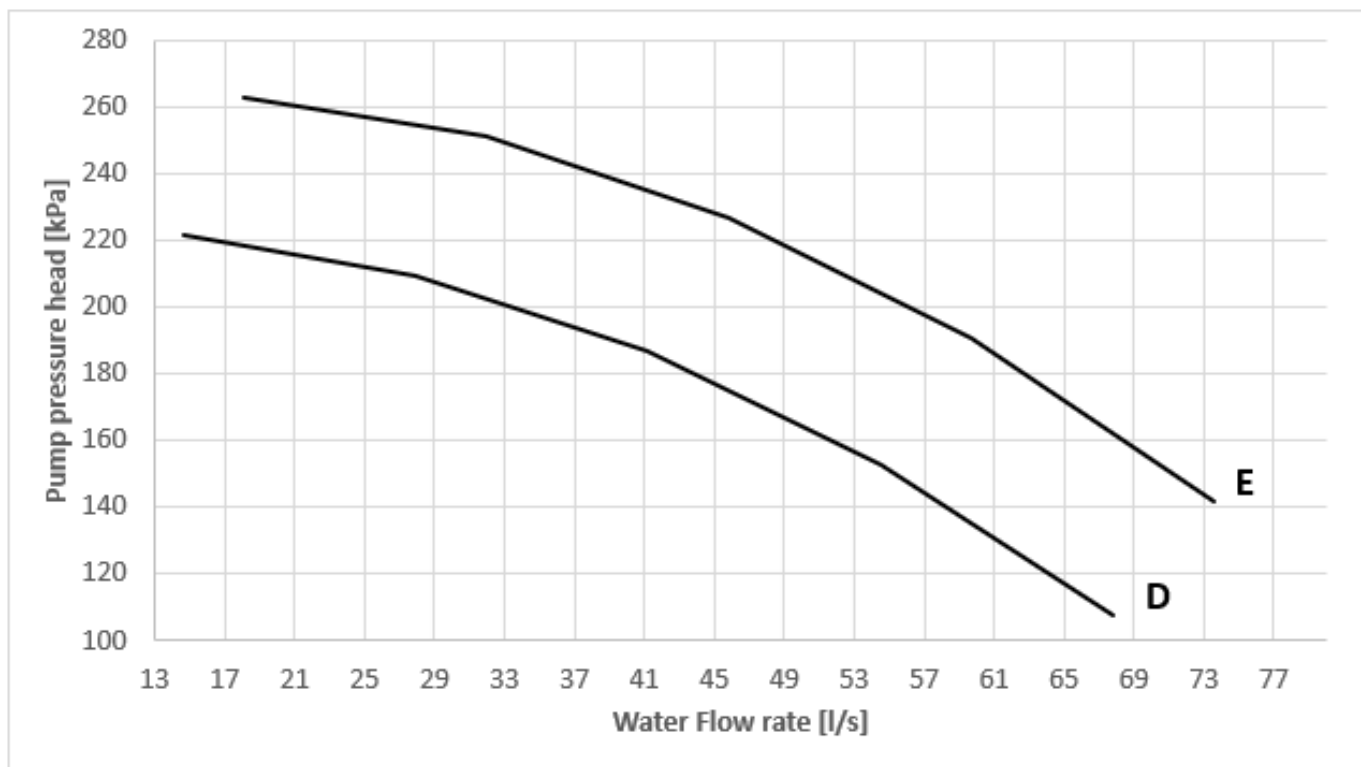

EWAH~TZ X- C / R1234ze - Single Pump Low Lift												
models	ref. curve	Pump motor power input	Pump motor current (5)	Power supply	PN	Motor protection	Insulation class	Water flow rate (1)	Evaporator pressure drop (1)	Filter pressure drop (2)	Pump water head @ std condition (3)	Available water head @ std condition (1) (4)
		kW	A	V – ph. – Hz	-	-	-	l/s	kPa	kPa	kPa	KPa
670	A	9,2	17,4	400 - 3 - 50	10	IP55	F	31,9	40	6	190	144
780	B	11	20,2	400 - 3 - 50	10	IP55	F	37,4	49	5	177	123
840	C	11	20,2	400 - 3 - 50	10	IP55	F	40,1	55	6	177	116
950	C	11	20,2	400 - 3 - 50	10	IP55	F	45,2	55	7	177	115
C10	C	11	20,2	400 - 3 - 50	10	IP55	F	48,4	37	2	169	130
C11	D	11	20,2	400 - 3 - 50	10	IP55	F	53,4	45	3	156	108
C12	E	11	20,2	400 - 3 - 50	10	IP55	F	59	35	4	138	100
C13	E	15	26,6	400 - 3 - 50	10	IP55	F	64,2	41	4	176	131
C14	E	15	26,6	400 - 3 - 50	10	IP55	F	68,8	47	5	160	109
C15	N.A.	N.A.	N.A.	N.A.	N.A.	N.A.	N.A.	N.A.	N.A.	N.A.	N.A.	N.A.

(1) Standard Rating Conditions for Air to water chillers according to EN14511:2 Outdoor Heat exchanger inlet dry bulb temperature 35°; Indoor heat exchanger inlet water temperature 12°C, outlet water temperature 7°C.  
 (2) The pressure drops for the filter are referred to the one provided by DAIKIN as option (option code 115). In case of filter provided by third party supplier the pressure drop in the table must not be considered.  
 (3) Total head of the pump.  
 (4) Available head external to the unit (already including the pressure drop in the exchanger and in the filter (if opt 115 is selected)  
 (5) Refer to 400 V power supply

The above data are referred to the unit without additional optional.  
 In case of unit with opt. 08, 154, 187 refer the selection sheet for the actual pressure drops.  
 The above data are referred the unit installed in compliancy with installation prescription.  
 All the data are subject to change without notice. For updated information on project base refer to Chiller Selection Software and unit nameplate.

EWAH~TZ X S/L/R C-

Single pump – High lift

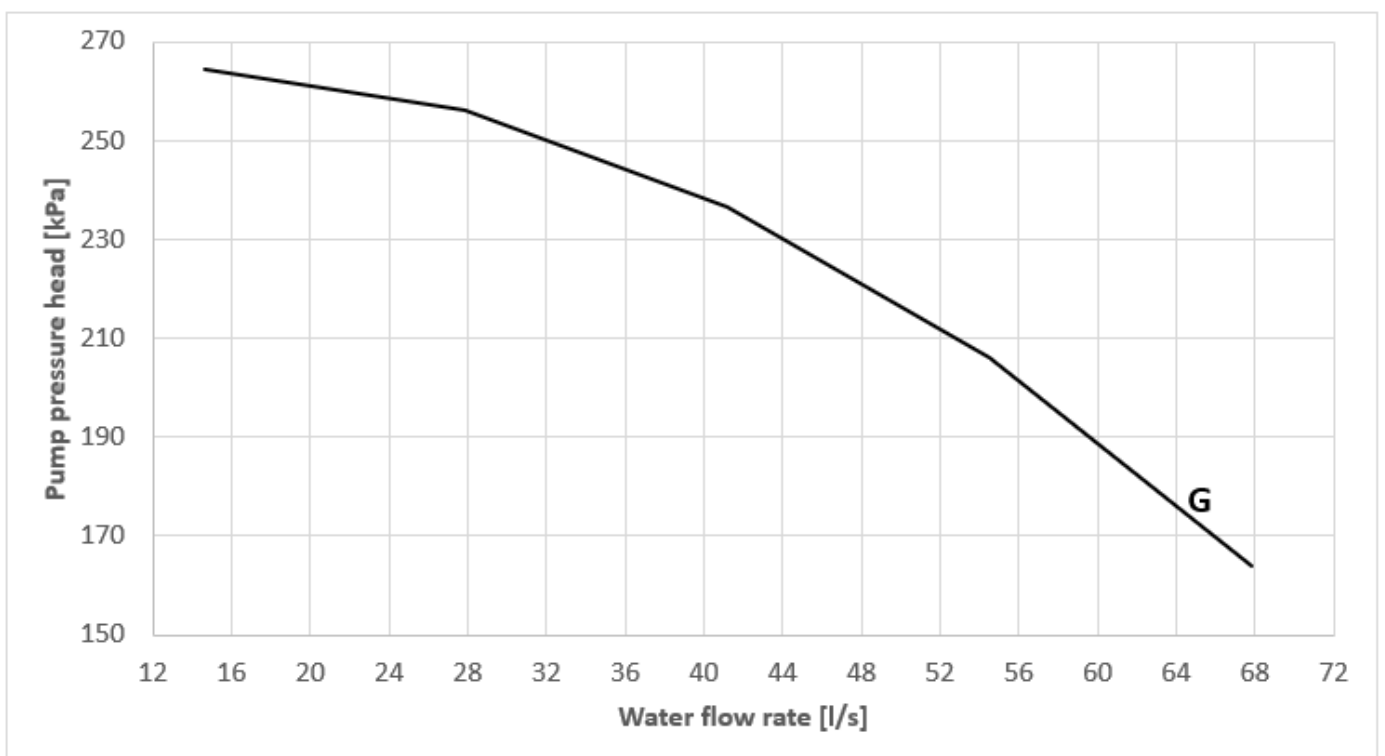
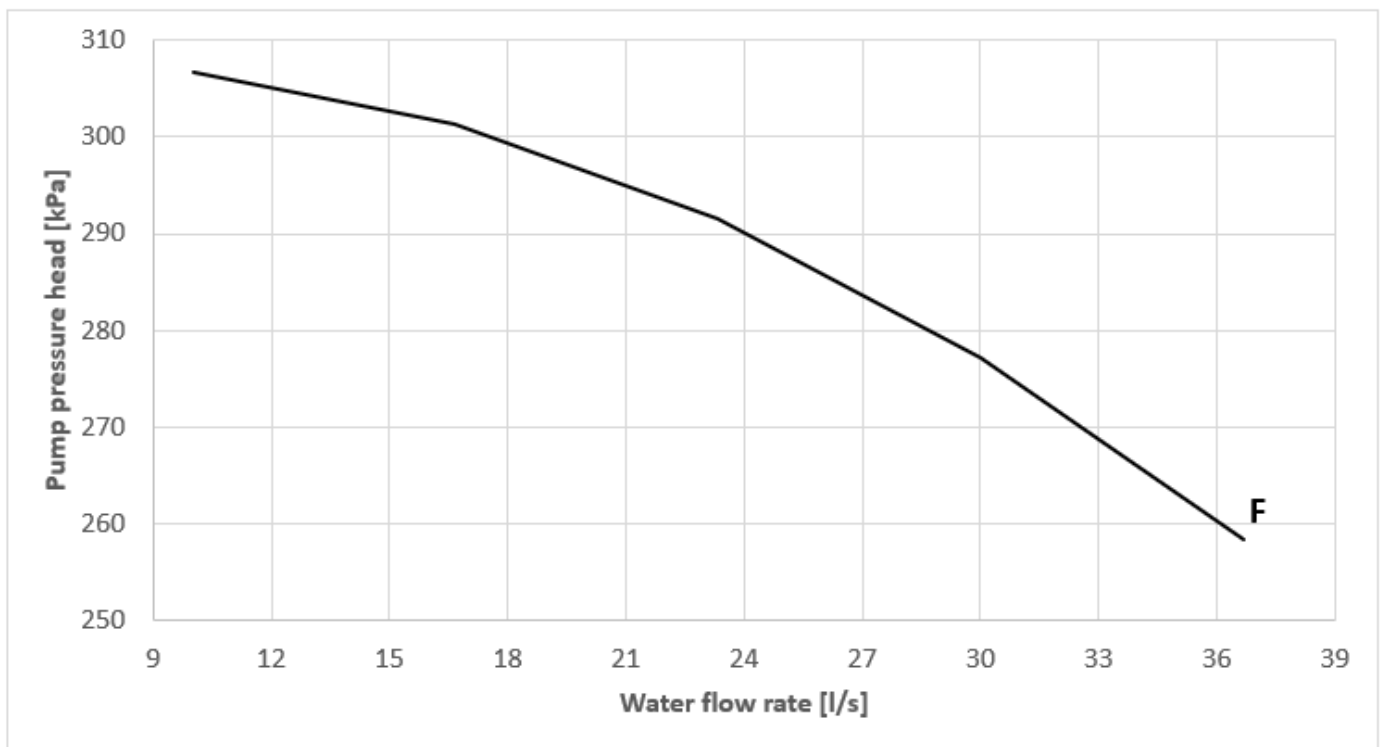

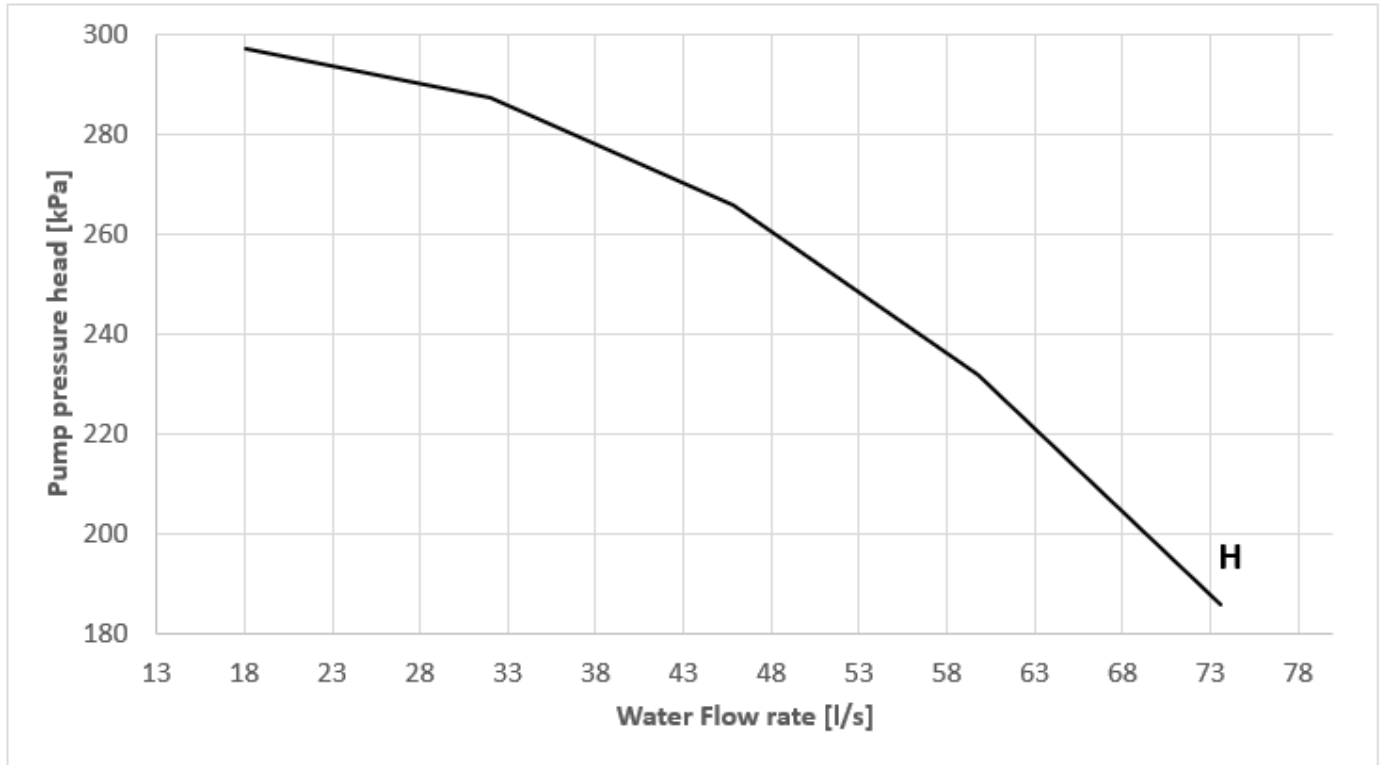

**EWAH~TZ X- C / R1234ze - Single Pump High Lift**

models	ref. curve	Pump motor power input	Pump motor current (5)	Power supply	PN	Motor protection	Insulation class	Water flow rate (1)	Evaporator pressure drop (1)	Filter pressure drop (2)	Pump water head @ std condition (3)	Available water head @ std condition (1) (4)
		kW	A	V – ph. – Hz	-	-	-	l/s	kPa	kPa	kPa	KPa
670	F	15	26,6	400 - 3 - 50	10	IP55	F	31,9	40	6	272	226
780	F	15	26,6	400 - 3 - 50	10	IP55	F	37,4	49	5	256	203
840	F	15	26,6	400 - 3 - 50	10	IP55	F	40,1	55	6	247	186
950	G	15	26,6	400 - 3 - 50	10	IP55	F	45,2	55	7	229	166
C10	G	15	26,6	400 - 3 - 50	10	IP55	F	48,4	37	2	221	182
C11	G	15	26,6	400 - 3 - 50	10	IP55	F	53,4	45	3	209	161
C12	H	18,5	32,7	400 - 3 - 50	10	IP55	F	59	35	4	234	195
C13	H	18,5	32,7	400 - 3 - 50	10	IP55	F	64,2	41	4	218	173
C14	H	18,5	32,7	400 - 3 - 50	10	IP55	F	68,8	47	5	203	152
C15	N.A.	N.A.	N.A.	N.A.	N.A.	N.A.	N.A.	N.A.	N.A.	N.A.	N.A.	N.A.

- (1) Standard Rating Conditions for Air to water chillers according to EN14511:2 Outdoor Heat exchanger inlet dry bulb temperature 35°; Indoor heat exchanger inlet water temperature 12°C, outlet water temperature 7°C.
- (2) The pressure drops for the filter are referred to the one provided by DAIKIN as option (option code 115). In case of filter provided by third party supplier the pressure drop in the table must not be considered.
- (3) Total head of the pump.
- (4) Available head external to the unit (already including the pressure drop in the exchanger and in the filter (if opt 115 is selected)
- (5) Refer to 400 V power supply

The above data are referred to the unit without additional optional.  
 In case of unit with opt. 08, 154, 187 refer the selection sheet for the actual pressure drops.  
 The above data are referred the unit installed in compliancy with installation prescription.  
 All the data are subject to change without notice. For updated information on project base refer to Chiller Selection Software and unit nameplate.

EWAH~TZ X S/L/R C-

Dual pump – Low lift

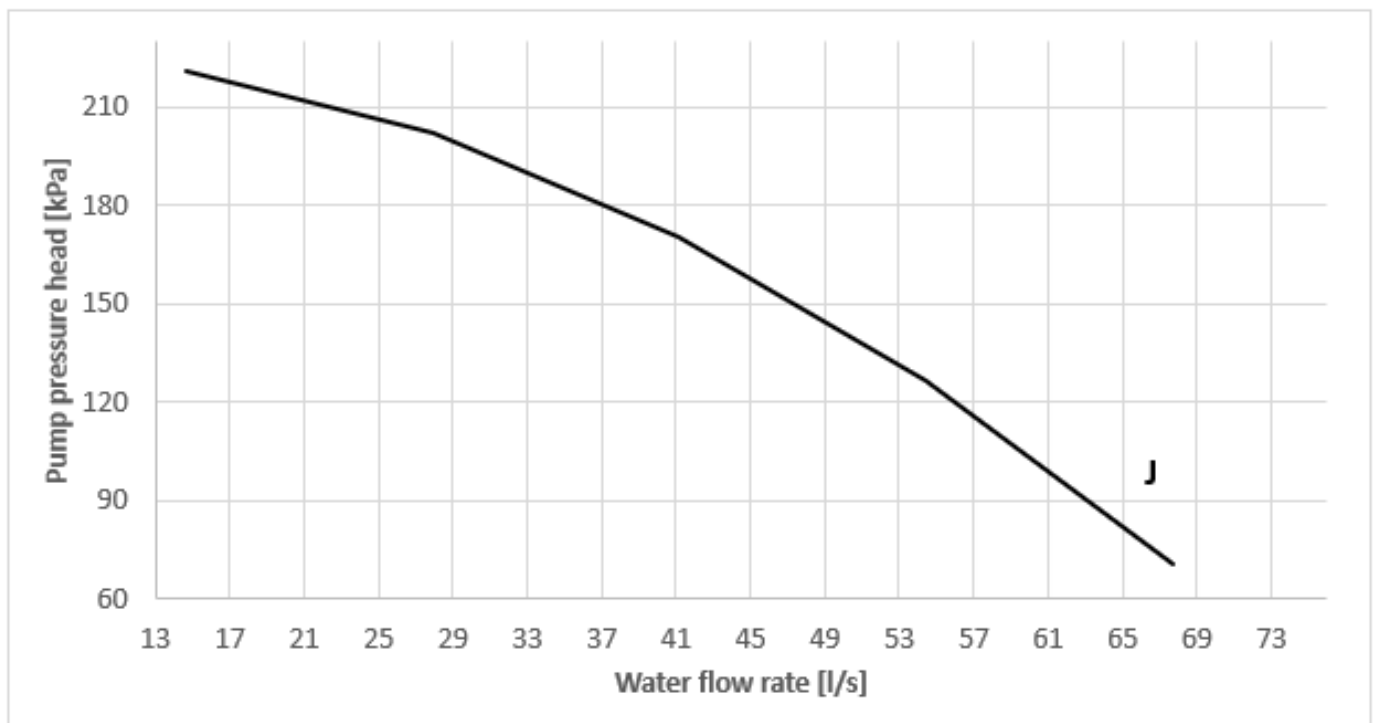
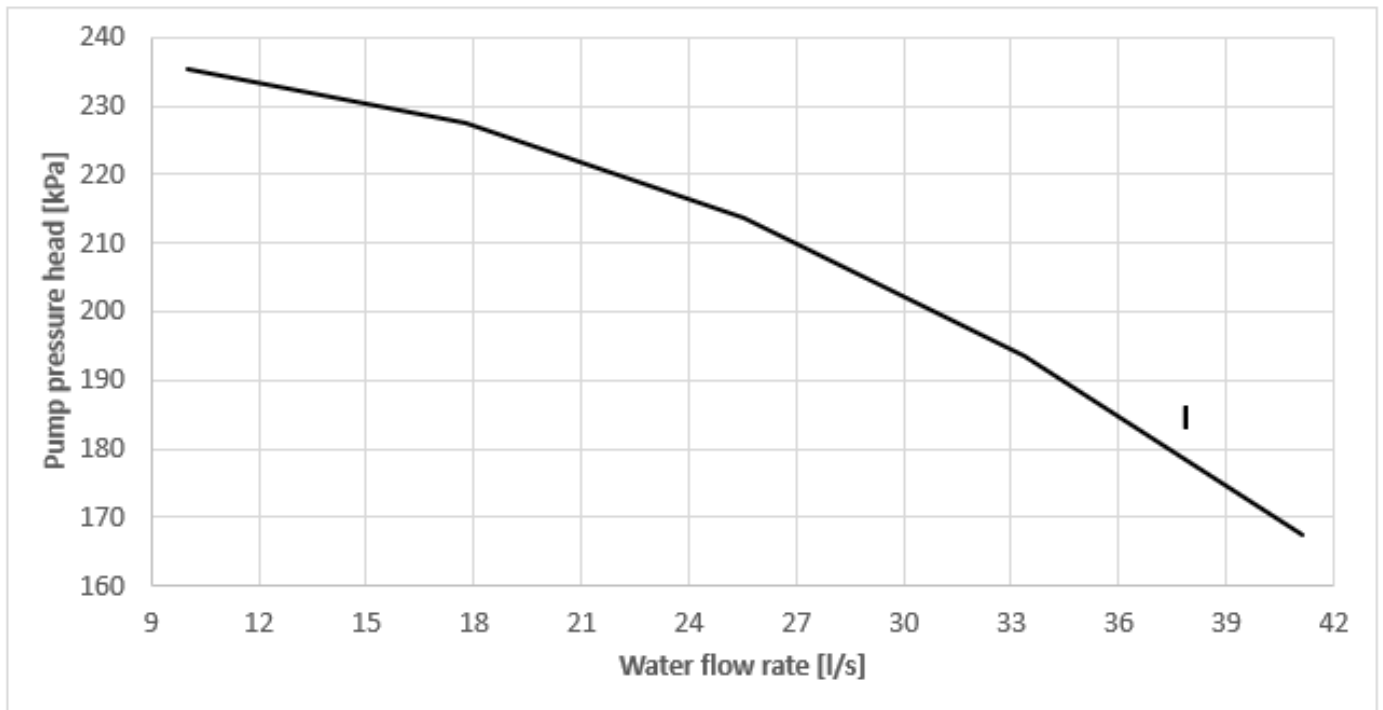

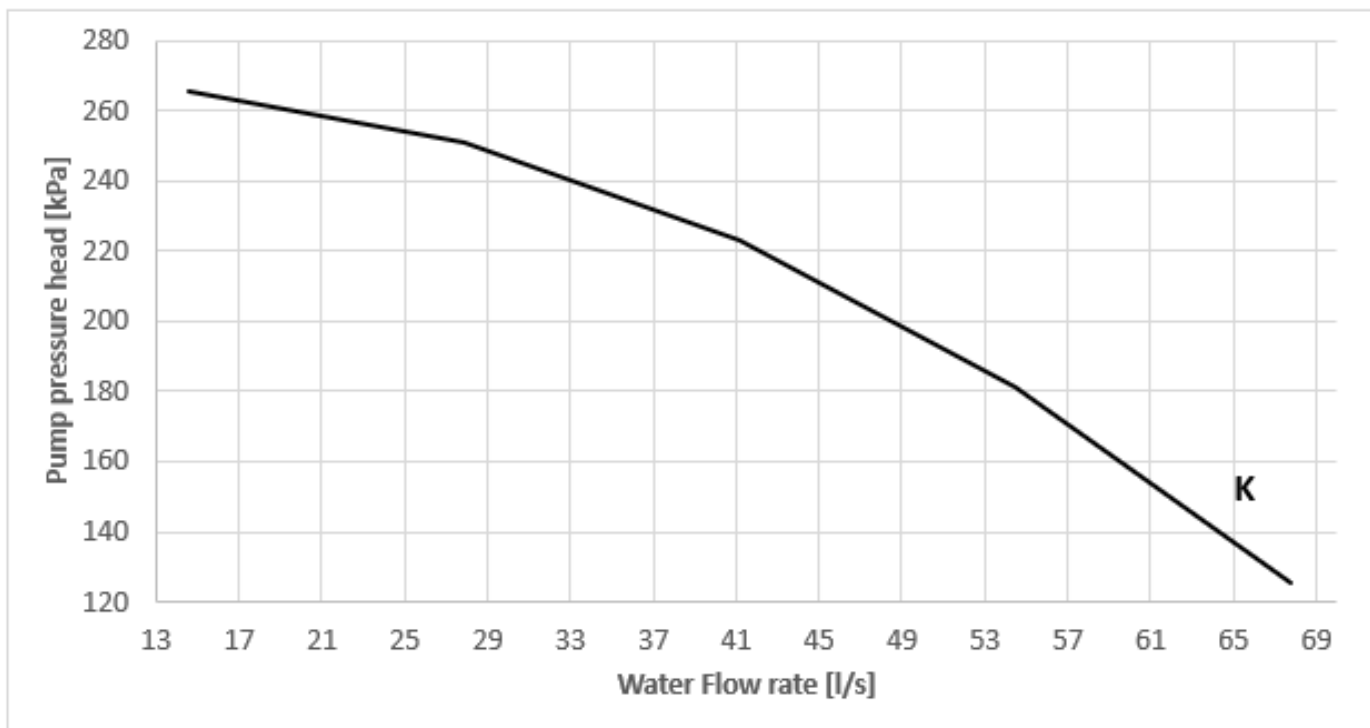

EWAH~TZ X- C / R1234ze - Dual Pump Low Lift												
models	ref. curve	Pump motor power input	Pump motor current (5)	Power supply	PN	Motor protection	Insulation class	Water flow rate (1)	Evaporator pressure drop (1)	Filter pressure drop (2)	Pump water head @ std condition (3)	Available water head @ std condition (1) (4)
		kW	A	V – ph. – Hz	-	-	-	l/s	kPa	kPa	kPa	KPa
670	I	11	20,2	400 - 3 - 50	10	IP55	F	31,9	40	6	198	152
780	I	11	20,2	400 - 3 - 50	10	IP55	F	37,4	49	5	181	127
840	I	11	20,2	400 - 3 - 50	10	IP55	F	40,1	55	6	171	110
950	J	11	20,2	400 - 3 - 50	10	IP55	F	45,2	55	7	159	96
C10	J	11	20,2	400 - 3 - 50	10	IP55	F	48,4	37	2	148	109
C11	J	11	20,2	400 - 3 - 50	10	IP55	F	53,4	45	3	131	84
C12	K	15	26,6	400 - 3 - 50	10	IP55	F	59	35	4	164	125
C13	K	15	26,6	400 - 3 - 50	10	IP55	F	64,2	41	4	142	96
C14	K	15	26,6	400 - 3 - 50	10	IP55	F	68,8	47	5	120	69
C15	N.A.	N.A.	N.A.	N.A.	N.A.	N.A.	N.A.	N.A.	N.A.	N.A.	N.A.	N.A.

(1) Standard Rating Conditions for Air to water chillers according to EN14511:2 Outdoor Heat exchanger inlet dry bulb temperature 35°; Indoor heat exchanger inlet water temperature 12°C, outlet water temperature 7°C.  
 (2) The pressure drops for the filter are referred to the one provided by DAIKIN as option (option code 115). In case of filter provided by third party supplier the pressure drop in the table must not be considered.  
 (3) Total head of the pump.  
 (4) Available head external to the unit (already including the pressure drop in the exchanger and in the filter (if opt 115 is selected)  
 (5) Refer to 400 V power supply

The above data are referred to the unit without additional optional.  
 In case of unit with opt. 08, 154, 187 refer the selection sheet for the actual pressure drops.  
 The above data are referred the unit installed in compliancy with installation prescription.  
 All the data are subject to change without notice. For updated information on project base refer to Chiller Selection Software and unit nameplate.

EWAH~TZ X S/L/R C-

Dual pump – High lift

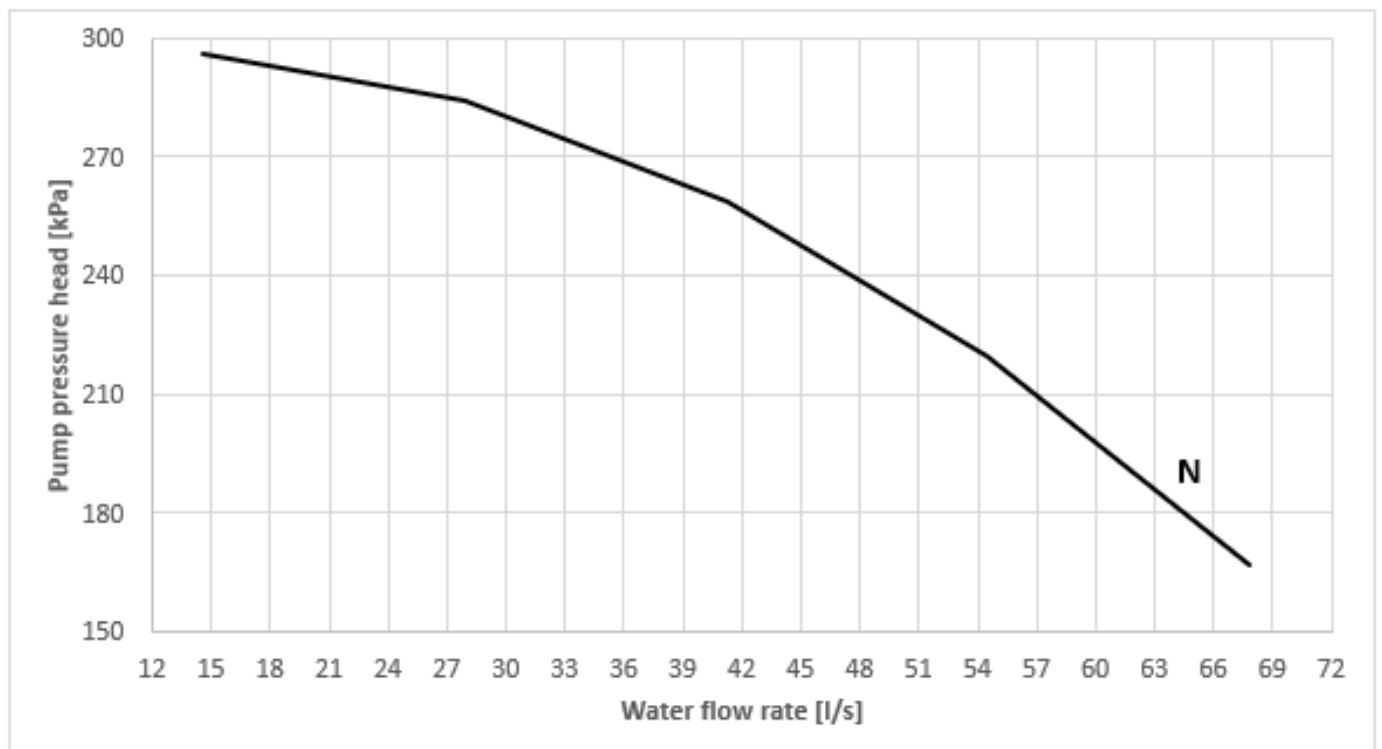
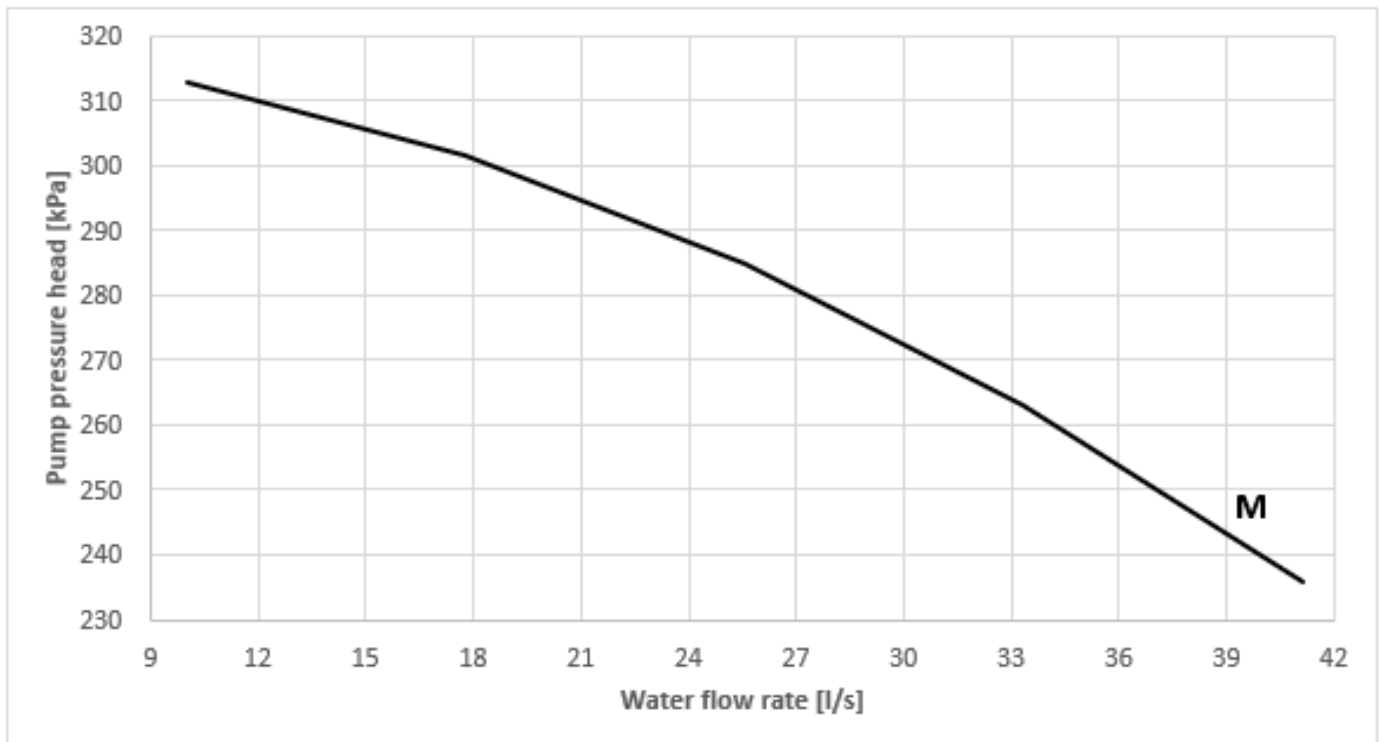

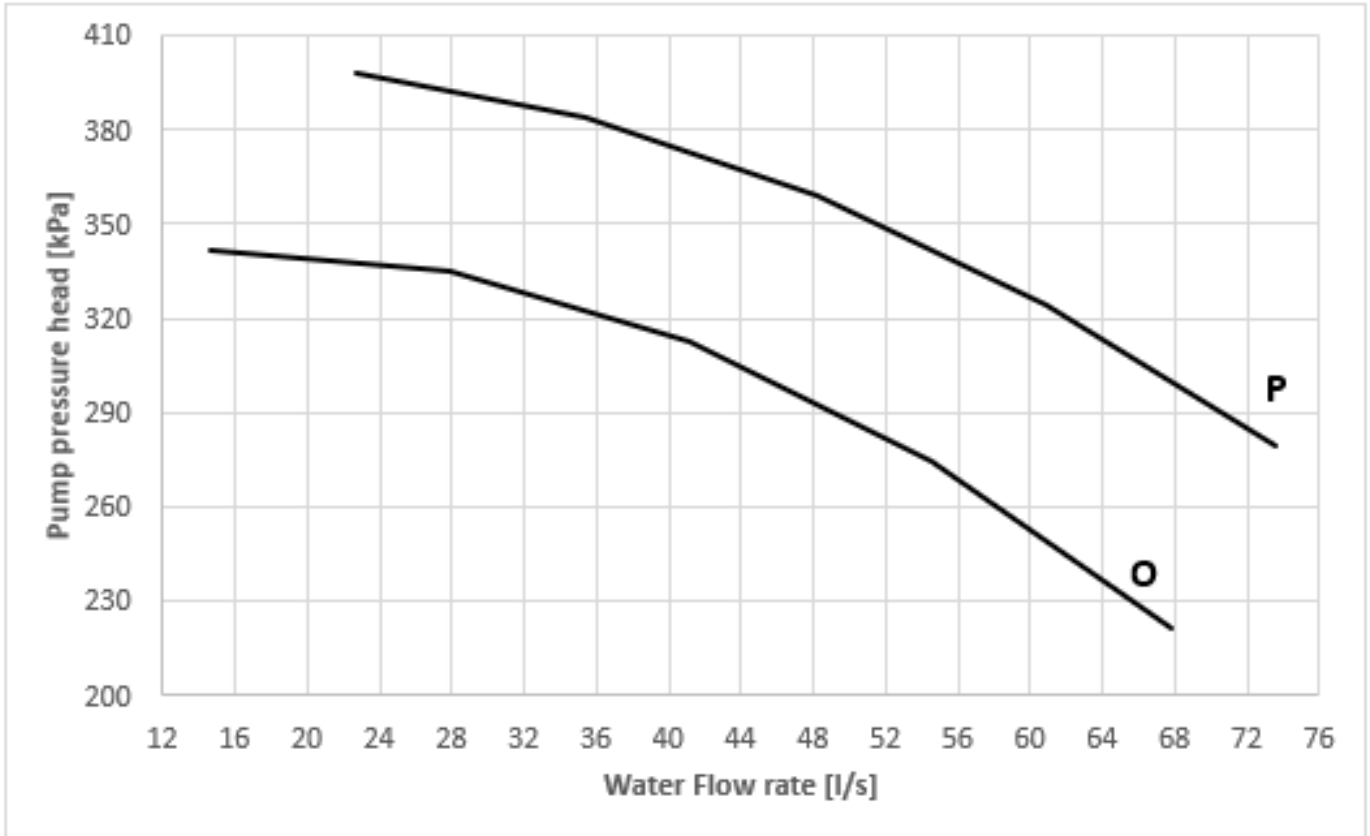

EWAH~TZ X- C / R1234ze - Dual Pump High Lift												
models	ref. curve	Pump motor power input	Pump motor current (5)	Power supply	PN	Motor protection	Insulation class	Water flow rate (1)	Evaporator pressure drop (1)	Filter pressure drop (2)	Pump water head @ std condition (3)	Available water head @ std condition (1) (4)
		kW	A	V – ph. – Hz	-	-	-	l/s	kPa	kPa	kPa	KPa
670	M	15	26,6	400 - 3 - 50	10	IP55	F	31,9	40	6	267	222
780	M	15	26,6	400 - 3 - 50	10	IP55	F	37,4	49	5	250	196
840	M	15	26,6	400 - 3 - 50	10	IP55	F	40,1	55	6	240	179
950	N	18,5	32,7	400 - 3 - 50	10	IP55	F	45,2	55	7	248	186
C10	N	18,5	32,7	400 - 3 - 50	10	IP55	F	48,4	37	2	239	200
C11	O	22	32,7	400 - 3 - 50	10	IP55	F	53,4	45	3	278	231
C12	O	22	42,2	400 - 3 - 50	10	IP55	F	59	35	4	258	219
C13	O	22	42,2	400 - 3 - 50	10	IP55	F	64,2	41	4	237	192
C14	P	30	52,7	400 - 3 - 50	10	IP55	F	68,8	47	5	297	246
C15	N.A.	N.A.	N.A.	N.A.	N.A.	N.A.	N.A.	N.A.	N.A.	N.A.	N.A.	N.A.

(1) Standard Rating Conditions for Air to water chillers according to EN14511:2 Outdoor Heat exchanger inlet dry bulb temperature 35°; Indoor heat exchanger inlet water temperature 12°C, outlet water temperature 7°C.  
 (2) The pressure drops for the filter are referred to the one provided by DAIKIN as option (option code 115). In case of filter provided by third party supplier the pressure drop in the table must not be considered.  
 (3) Total head of the pump.  
 (4) Available head external to the unit (already including the pressure drop in the exchanger and in the filter (if opt 115 is selected)  
 (5) Refer to 400 V power supply

The above data are referred to the unit without additional optional.  
 In case of unit with opt. 08, 154, 187 refer the selection sheet for the actual pressure drops.  
 The above data are referred the unit installed in compliancy with installation prescription.  
 All the data are subject to change without notice. For updated information on project base refer to Chiller Selection Software and unit nameplate.

EWAD~TZ S S/L/R C-

Single pump – Low lift

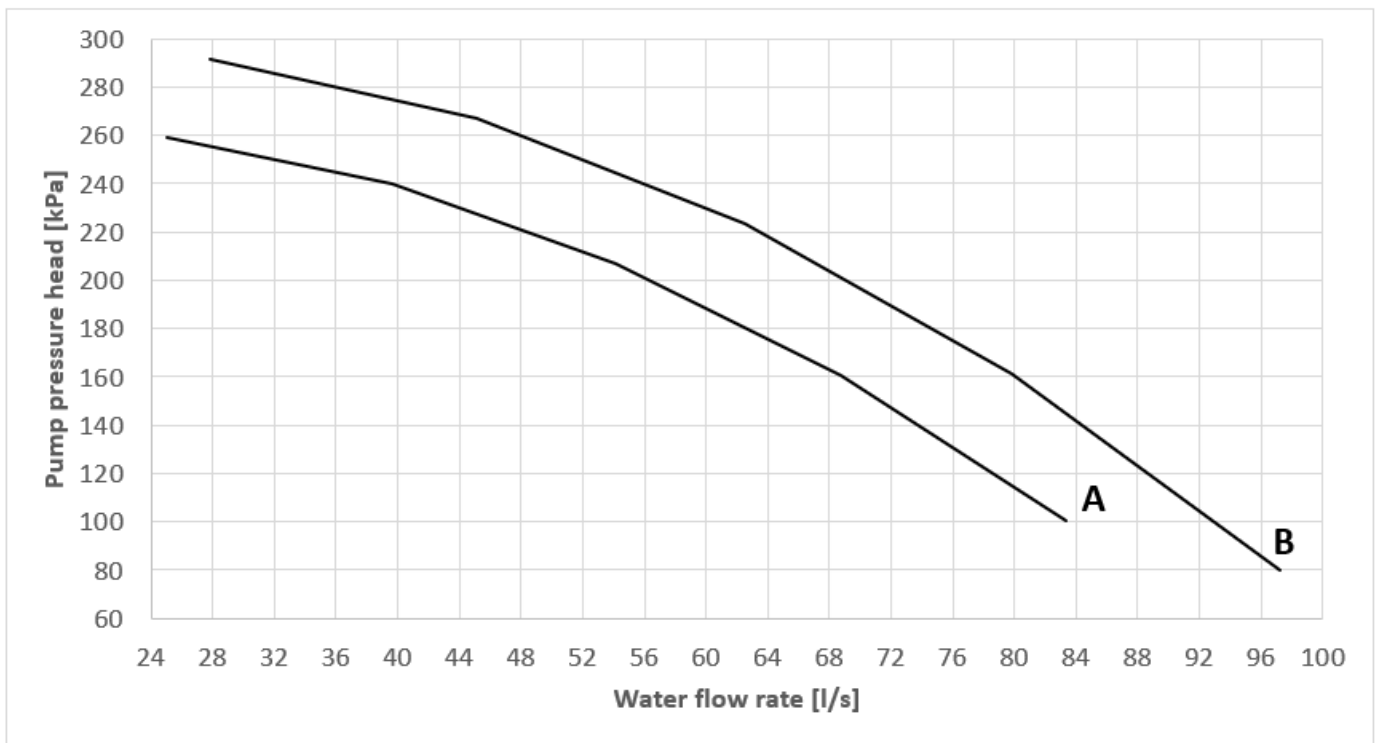

EWAD~TZ S- C / R134a - Single Pump Low Lift												
models	ref. curve	Pump motor power input	Pump motor current (5)	Power supply	PN	Motor protection	Insulation class	Water flow rate (1)	Evaporator pressure drop (1)	Filter pressure drop (2)	Pump water head @ std condition (3)	Available water head @ std condition (1) (4)
		kW	A	V – ph. – Hz	-	-	-	l/s	kPa	kPa	kPa	KPa
H11	A	15	26,6	400 - 3 - 50	10	IP55	F	56,7	57	11	200	131
H12	A	15	26,6	400 - 3 - 50	10	IP55	F	60	63	13	190	114
H13	A	15	26,6	400 - 3 - 50	10	IP55	F	64,6	41	4	175	130
C15	B	18,5	32,7	400 - 3 - 50	10	IP55	F	71,9	49	5	192	138
C16	N.A.	N.A.	N.A.	N.A.	N.A.	N.A.	N.A.	N.A.	N.A.	N.A.	N.A.	N.A.
H17	N.A.	N.A.	N.A.	N.A.	N.A.	N.A.	N.A.	N.A.	N.A.	N.A.	N.A.	N.A.
H18	N.A.	N.A.	N.A.	N.A.	N.A.	N.A.	N.A.	N.A.	N.A.	N.A.	N.A.	N.A.
H19	N.A.	N.A.	N.A.	N.A.	N.A.	N.A.	N.A.	N.A.	N.A.	N.A.	N.A.	N.A.

(1) Standard Rating Conditions for Air to water chillers according to EN14511:2 Outdoor Heat exchanger inlet dry bulb temperature 35°; Indoor heat exchanger inlet water temperature 12°C, outlet water temperature 7°C.  
 (2) The pressure drops for the filter are referred to the one provided by DAIKIN as option (option code 115). In case of filter provided by third party supplier the pressure drop in the table must not be considered.  
 (3) Total head of the pump.  
 (4) Available head external to the unit (already including the pressure drop in the exchanger and in the filter (if opt 115 is selected)  
 (5) Refer to 400 V power supply

The above data are referred to the unit without additional optional.  
 In case of unit with opt. 08, 154, 187 refer the selection sheet for the actual pressure drops.  
 The above data are referred the unit installed in compliancy with installation prescription.  
 All the data are subject to change without notice. For updated information on project base refer to Chiller Selection Software and unit nameplate.



EWAD~TZ S S/L/R C-

Single pump – High lift

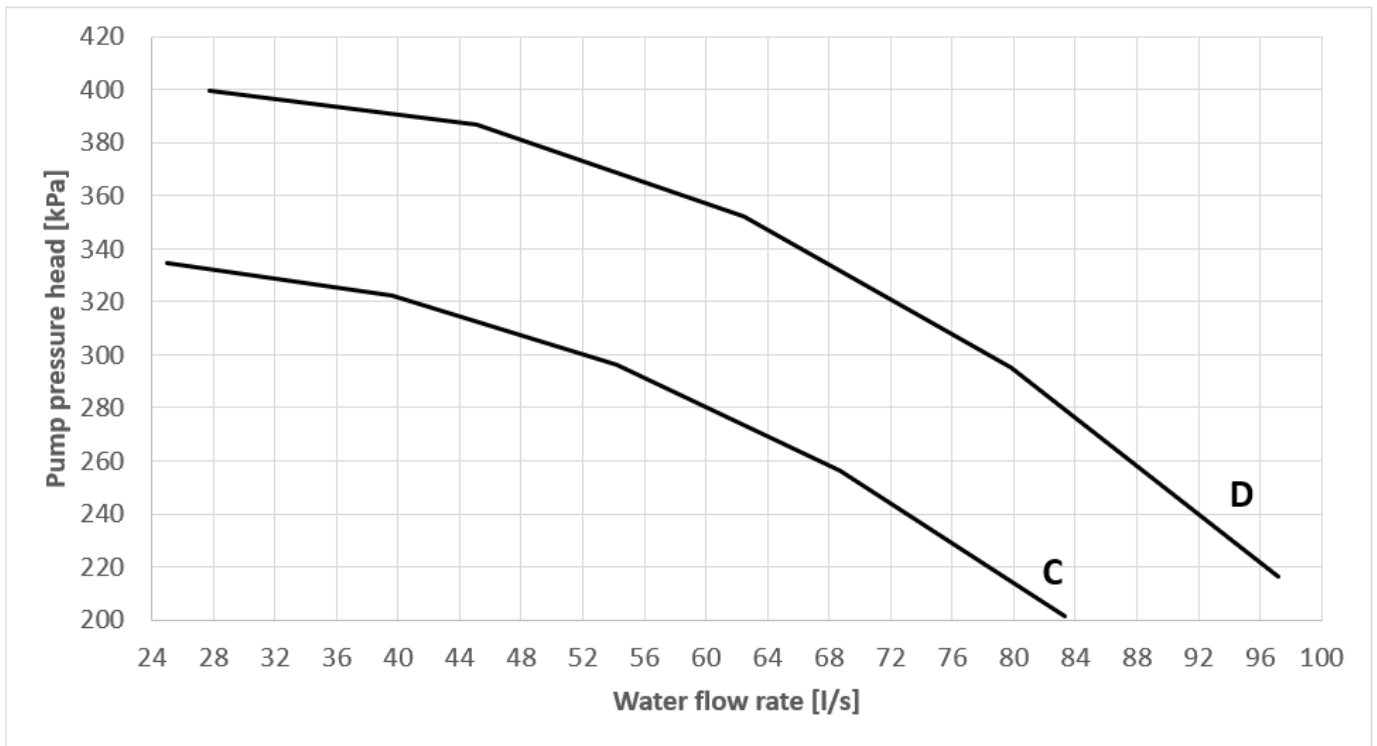

EWAD~TZ S- C / R134a - Single Pump High Lift												
models	ref. curve	Pump motor power input	Pump motor current (5)	Power supply	PN	Motor protection	Insulation class	Water flow rate (1)	Evaporator pressure drop (1)	Filter pressure drop (2)	Pump water head @ std condition (3)	Available water head @ std condition (1) (4)
		kW	A	V – ph. – Hz	-	-	-	l/s	kPa	kPa	kPa	KPa
H11	C	22	42,2	400 - 3 - 50	10	IP55	F	56,7	57	11	291	222
H12	C	22	42,2	400 - 3 - 50	10	IP55	F	60	63	13	282	206
H13	C	22	42,2	400 - 3 - 50	10	IP55	F	64,6	41	4	269	224
C15	D	30	52,2	400 - 3 - 50	10	IP55	F	71,9	49	5	324	270
C16	N.A.	N.A.	N.A.	N.A.	N.A.	N.A.	N.A.	N.A.	N.A.	N.A.	N.A.	N.A.
H17	N.A.	N.A.	N.A.	N.A.	N.A.	N.A.	N.A.	N.A.	N.A.	N.A.	N.A.	N.A.
H18	N.A.	N.A.	N.A.	N.A.	N.A.	N.A.	N.A.	N.A.	N.A.	N.A.	N.A.	N.A.
H19	N.A.	N.A.	N.A.	N.A.	N.A.	N.A.	N.A.	N.A.	N.A.	N.A.	N.A.	N.A.

(1) Standard Rating Conditions for Air to water chillers according to EN14511:2 Outdoor Heat exchanger inlet dry bulb temperature 35°; Indoor heat exchanger inlet water temperature 12°C, outlet water temperature 7°C.  
 (2) The pressure drops for the filter are referred to the one provided by DAIKIN as option (option code 115). In case of filter provided by third party supplier the pressure drop in the table must not be considered.  
 (3) Total head of the pump.  
 (4) Available head external to the unit (already including the pressure drop in the exchanger and in the filter (if opt 115 is selected)  
 (5) Refer to 400 V power supply

The above data are referred to the unit without additional optional.  
 In case of unit with opt. 08, 154, 187 refer the selection sheet for the actual pressure drops.  
 The above data are referred the unit installed in compliance with installation prescription.  
 All the data are subject to change without notice. For updated information on project base refer to Chiller Selection Software and unit nameplate.

EWAD~TZ S S/L/R C-

Dual pump – Low lift

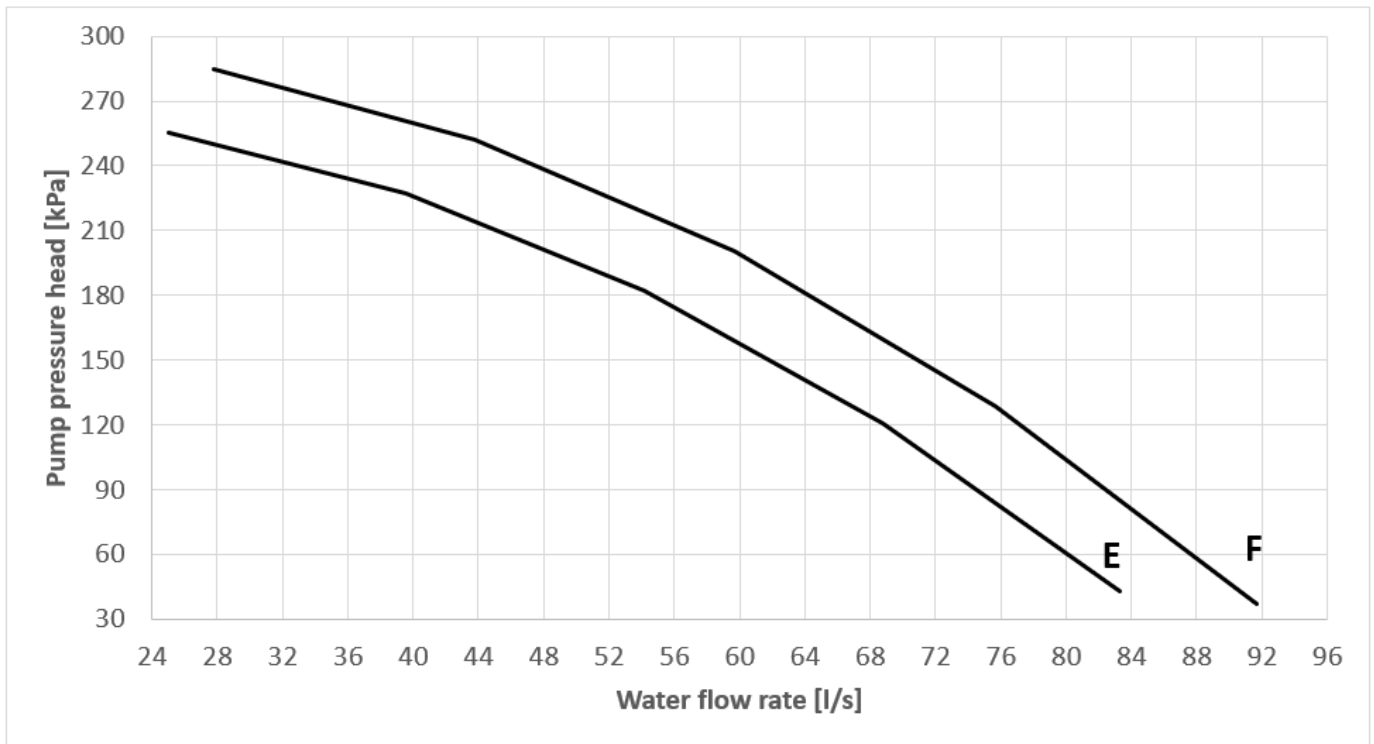

EWAD~TZ S- C / R134a - Dual Pump Low Lift												
models	ref. curve	Pump motor power input	Pump motor current (5)	Power supply	PN	Motor protection	Insulation class	Water flow rate (1)	Evaporator pressure drop (1)	Filter pressure drop (2)	Pump water head @ std condition (3)	Available water head @ std condition (1) (4)
		kW	A	V – ph. – Hz	-	-	-	l/s	kPa	kPa	kPa	KPa
H11	E	15	26,6	400 - 3 - 50	10	IP55	F	56,7	57	11	173	104
H12	E	15	26,6	400 - 3 - 50	10	IP55	F	60	63	13	160	83
H13	E	15	32,7	400 - 3 - 50	10	IP55	F	64,6	41	4	140	95
C15	F	18,5	32,7	400 - 3 - 50	10	IP55	F	71,9	49	5	147	93
C16	N.A.	N.A.	N.A.	N.A.	N.A.	N.A.	N.A.	N.A.	N.A.	N.A.	N.A.	N.A.
H17	N.A.	N.A.	N.A.	N.A.	N.A.	N.A.	N.A.	N.A.	N.A.	N.A.	N.A.	N.A.
H18	N.A.	N.A.	N.A.	N.A.	N.A.	N.A.	N.A.	N.A.	N.A.	N.A.	N.A.	N.A.
H19	N.A.	N.A.	N.A.	N.A.	N.A.	N.A.	N.A.	N.A.	N.A.	N.A.	N.A.	N.A.

(1) Standard Rating Conditions for Air to water chillers according to EN14511:2 Outdoor Heat exchanger inlet dry bulb temperature 35°; Indoor heat exchanger inlet water temperature 12°C, outlet water temperature 7°C.  
 (2) The pressure drops for the filter are referred to the one provided by DAIKIN as option (option code 115). In case of filter provided by third party supplier the pressure drop in the table must not be considered.  
 (3) Total head of the pump.  
 (4) Available head external to the unit (already including the pressure drop in the exchanger and in the filter (if opt 115 is selected)  
 (5) Refer to 400 V power supply

The above data are referred to the unit without additional optional.  
 In case of unit with opt. 08, 154, 187 refer the selection sheet for the actual pressure drops.  
 The above data are referred the unit installed in compliancy with installation prescription.  
 All the data are subject to change without notice. For updated information on project base refer to Chiller Selection Software and unit nameplate.

EWAD~TZ S S/L/R C-

Dual pump – High Lift

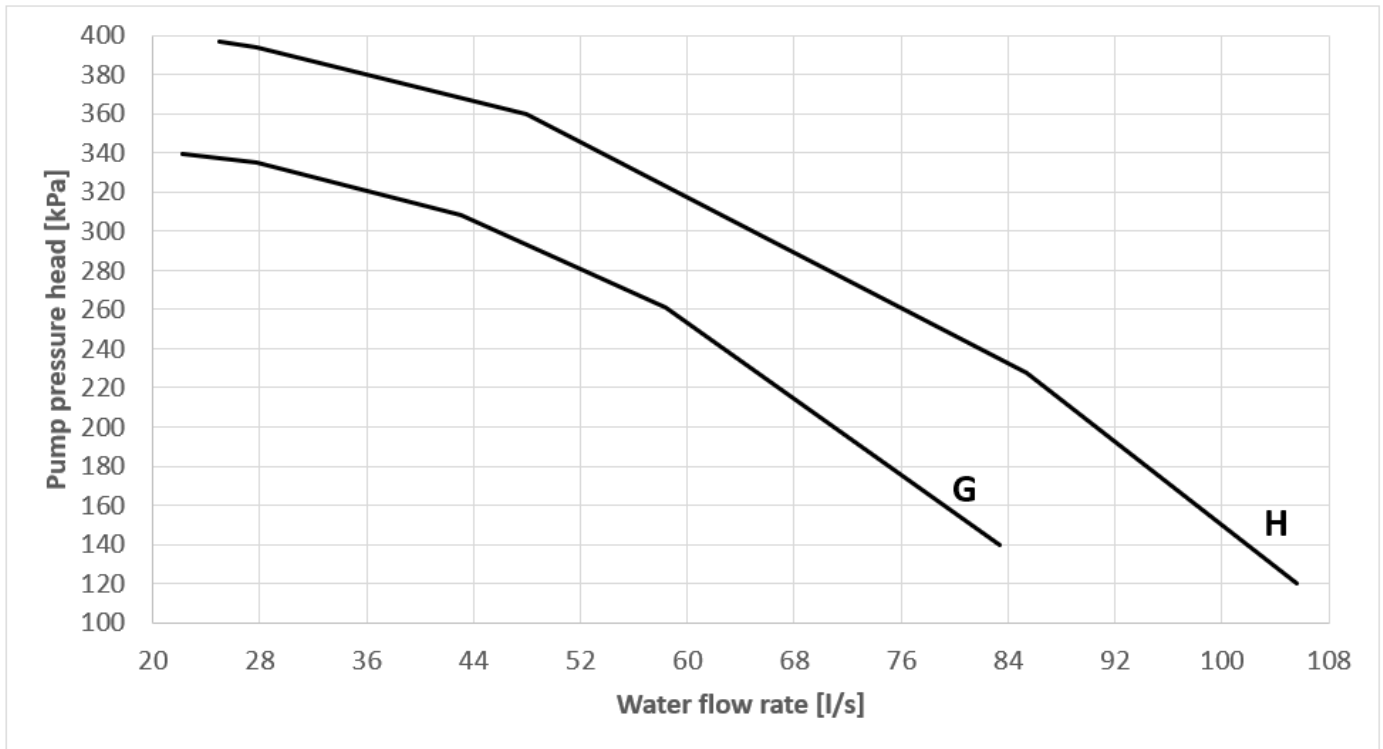

EWAD~TZ S- C / R134a - Dual Pump High Lift												
models	ref. curve	Pump motor power input	Pump motor current (5)	Power supply	PN	Motor protection	Insulation class	Water flow rate (1)	Evaporator pressure drop (1)	Filter pressure drop (2)	Pump water head @ std condition (3)	Available water head @ std condition (1) (4)
		kW	A	V – ph. – Hz	-	-	-	l/s	kPa	kPa	kPa	KPa
H11	G	22	42,2	400 - 3 - 50	10	IP55	F	56,7	57	11	267	198
H12	H	30	42,2	400 - 3 - 50	10	IP55	F	60	63	13	327	251
H13	H	30	42,2	400 - 3 - 50	10	IP55	F	64,6	41	4	312	268
C15	H	30	52,2	400 - 3 - 50	10	IP55	F	71,9	49	5	286	232
C16	N.A.	N.A.	N.A.	N.A.	N.A.	N.A.	N.A.	N.A.	N.A.	N.A.	N.A.	N.A.
H17	N.A.	N.A.	N.A.	N.A.	N.A.	N.A.	N.A.	N.A.	N.A.	N.A.	N.A.	N.A.
H18	N.A.	N.A.	N.A.	N.A.	N.A.	N.A.	N.A.	N.A.	N.A.	N.A.	N.A.	N.A.
H19	N.A.	N.A.	N.A.	N.A.	N.A.	N.A.	N.A.	N.A.	N.A.	N.A.	N.A.	N.A.

(1) Standard Rating Conditions for Air to water chillers according to EN14511:2 Outdoor Heat exchanger inlet dry bulb temperature 35°; Indoor heat exchanger inlet water temperature 12°C, outlet water temperature 7°C.  
 (2) The pressure drops for the filter are referred to the one provided by DAIKIN as option (option code 115). In case of filter provided by third party supplier the pressure drop in the table must not be considered.  
 (3) Total head of the pump.  
 (4) Available head external to the unit (already including the pressure drop in the exchanger and in the filter (if opt 115 is selected)  
 (5) Refer to 400 V power supply

The above data are referred to the unit without additional optional.  
 In case of unit with opt. 08, 154, 187 refer the selection sheet for the actual pressure drops.  
 The above data are referred the unit installed in compliance with installation prescription.  
 All the data are subject to change without notice. For updated information on project base refer to Chiller Selection Software and unit nameplate.

EWAD~TZ X S/R C-

Single pump – Low Lift

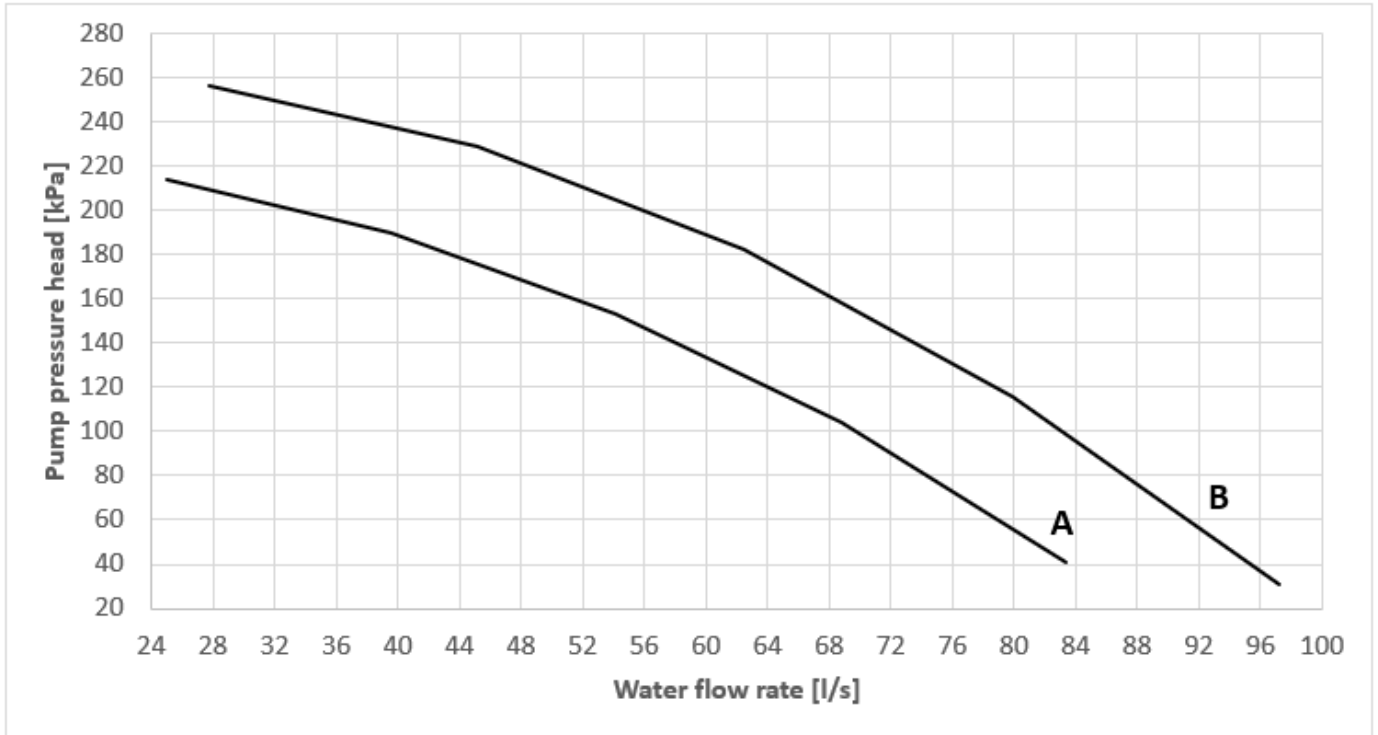

EWAD~TZ X- C / R134a – Single Pump Low Lift												
models	ref. curve	Pump motor power input	Pump motor current (5)	Power supply	PN	Motor protection	Insulation class	Water flow rate (1)	Evaporator pressure drop (1)	Filter pressure drop (2)	Pump water head @ std condition (3)	Available water head @ std condition (1) (4)
		kW	A	V – ph. – Hz	-	-	-	l/s	kPa	kPa	kPa	KPa
C11	A	11	20,2	400 - 3 - 50	10	IP55	F	53,6	52	10	155	93
C12	A	11	20,2	400 - 3 - 50	10	IP55	F	57,5	33	3	143	107
H12	A	11	20,2	400 - 3 - 50	10	IP55	F	61,1	37	4	131	91
C14	B	15	26,6	400 - 3 - 50	10	IP55	F	66,7	43	4	168	120
C15	N.A.	N.A.	N.A.	N.A.	N.A.	N.A.	N.A.	N.A.	N.A.	N.A.	N.A.	N.A.
H16	N.A.	N.A.	N.A.	N.A.	N.A.	N.A.	N.A.	N.A.	N.A.	N.A.	N.A.	N.A.
H17	N.A.	N.A.	N.A.	N.A.	N.A.	N.A.	N.A.	N.A.	N.A.	N.A.	N.A.	N.A.

(1) Standard Rating Conditions for Air to water chillers according to EN14511:2 Outdoor Heat exchanger inlet dry bulb temperature 35°; Indoor heat exchanger inlet water temperature 12°C, outlet water temperature 7°C.  
 (2) The pressure drops for the filter are referred to the one provided by DAIKIN as option (option code 115). In case of filter provided by third party supplier the pressure drop in the table must not be considered.  
 (3) Total head of the pump.  
 (4) Available head external to the unit (already including the pressure drop in the exchanger and in the filter (if opt 115 is selected)  
 (5) Refer to 400 V power supply

The above data are referred to the unit without additional optional.  
 In case of unit with opt. 08, 154, 187 refer the selection sheet for the actual pressure drops.  
 The above data are referred the unit installed in compliancy with installation prescription.  
 All the data are subject to change without notice. For updated information on project base refer to Chiller Selection Software and unit nameplate.

EWAD~TZ X S/R C-

Single pump – High Lift

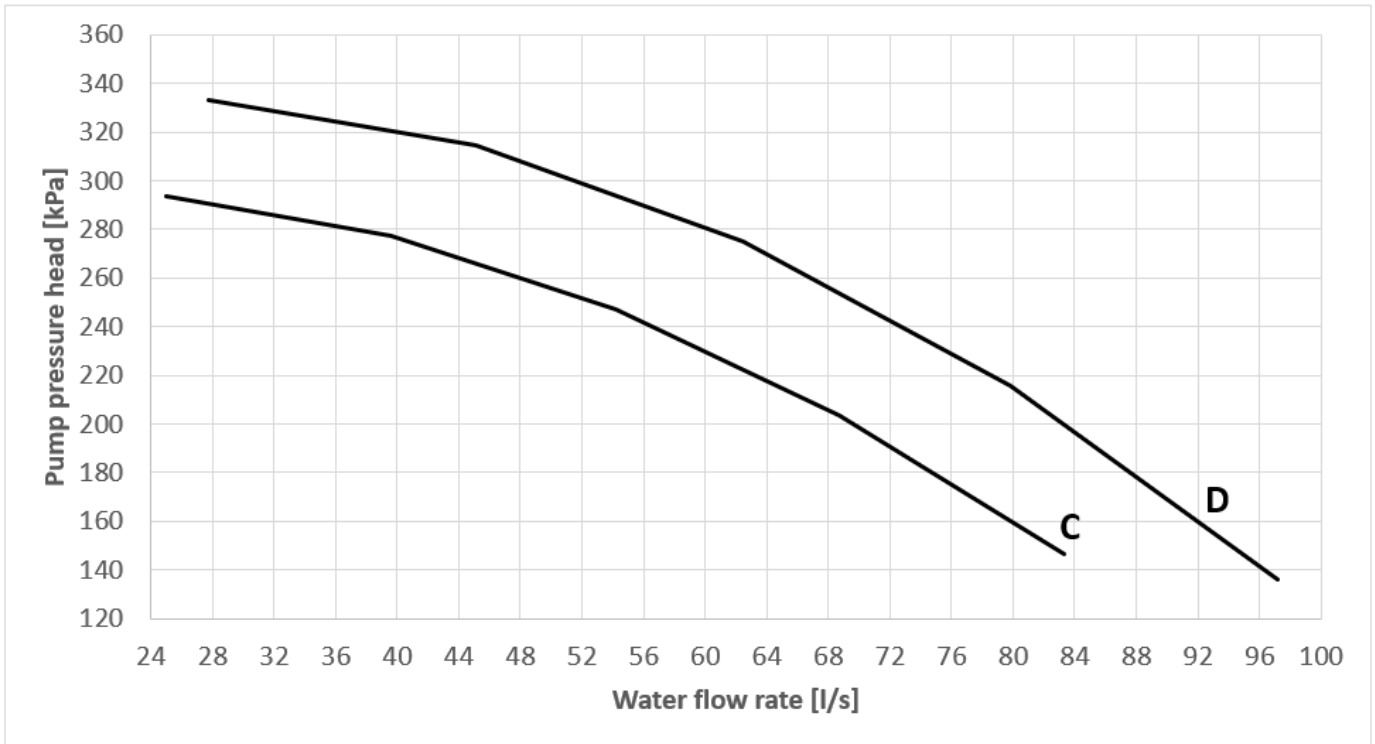

EWAD~TZ X- C / R134a – Single Pump High Lift												
models	ref. curve	Pump motor power input	Pump motor current (5)	Power supply	PN	Motor protection	Insulation class	Water flow rate (1)	Evaporator pressure drop (1)	Filter pressure drop (2)	Pump water head @ std condition (3)	Available water head @ std condition (1) (4)
		kW	A	V – ph. – Hz	-	-	-	l/s	kPa	kPa	kPa	KPa
C11	C	18,5	32,7	400 - 3 - 50	10	IP55	F	53,6	52	10	248	186
C12	C	18,5	32,7	400 - 3 - 50	10	IP55	F	57,5	33	3	238	202
H12	D	22	42,2	400 - 3 - 50	10	IP55	F	61,1	37	4	279	239
C14	D	22	42,2	400 - 3 - 50	10	IP55	F	66,7	43	4	263	215
C15	N.A.	N.A.	N.A.	N.A.	N.A.	N.A.	N.A.	N.A.	N.A.	N.A.	N.A.	N.A.
H16	N.A.	N.A.	N.A.	N.A.	N.A.	N.A.	N.A.	N.A.	N.A.	N.A.	N.A.	N.A.
H17	N.A.	N.A.	N.A.	N.A.	N.A.	N.A.	N.A.	N.A.	N.A.	N.A.	N.A.	N.A.

(1) Standard Rating Conditions for Air to water chillers according to EN14511:2 Outdoor Heat exchanger inlet dry bulb temperature 35°; Indoor heat exchanger inlet water temperature 12°C, outlet water temperature 7°C.  
 (2) The pressure drops for the filter are referred to the one provided by DAIKIN as option (option code 115). In case of filter provided by third party supplier the pressure drop in the table must not be considered.  
 (3) Total head of the pump.  
 (4) Available head external to the unit (already including the pressure drop in the exchanger and in the filter (if opt 115 is selected)  
 (5) Refer to 400 V power supply

The above data are referred to the unit without additional optional.  
 In case of unit with opt. 08, 154, 187 refer the selection sheet for the actual pressure drops.  
 The above data are referred the unit installed in compliancy with installation prescription.  
 All the data are subject to change without notice. For updated information on project base refer to Chiller Selection Software and unit nameplate.

**EWAD~TZ X S/R C-**

**Dual pump – Low Lift**

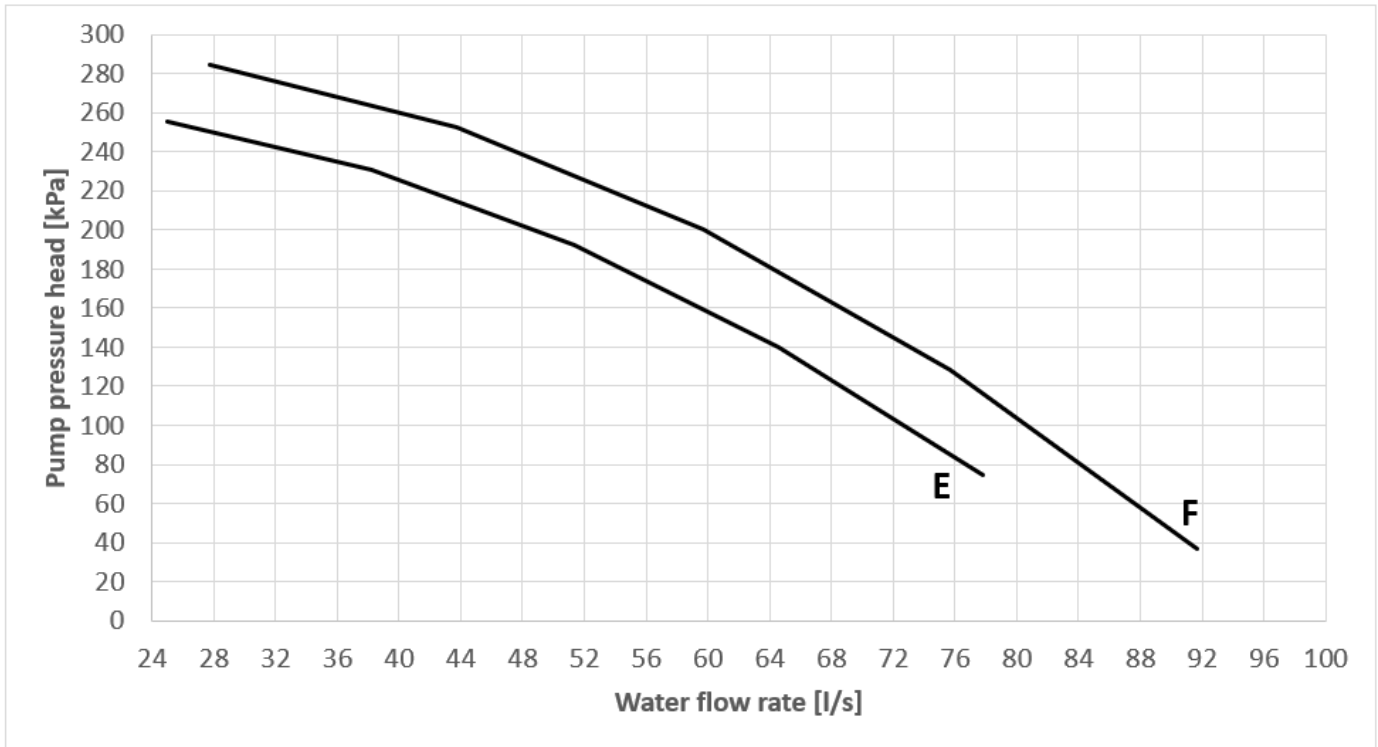

EWAD~TZ X- C / R134a – Dual Pump Low Lift												
models	ref. curve	Pump motor power input	Pump motor current (5)	Power supply	PN	Motor protection	Insulation class	Water flow rate (1)	Evaporator pressure drop (1)	Filter pressure drop (2)	Pump water head @ std condition (3)	Available water head @ std condition (1) (4)
		kW	A	V – ph. – Hz	-	-	-	l/s	kPa	kPa	kPa	KPa
C11	E	15	26,6	400 - 3 - 50	10	IP55	F	53,6	52	10	184	122
C12	E	15	26,6	400 - 3 - 50	10	IP55	F	57,5	33	3	170	133
H12	E	15	26,6	400 - 3 - 50	10	IP55	F	61,1	37	4	155	115
C14	F	18,5	32,7	400 - 3 - 50	10	IP55	F	66,7	43	4	171	124
C15	N.A.	N.A.	N.A.	N.A.	N.A.	N.A.	N.A.	N.A.	N.A.	N.A.	N.A.	N.A.
H16	N.A.	N.A.	N.A.	N.A.	N.A.	N.A.	N.A.	N.A.	N.A.	N.A.	N.A.	N.A.
H17	N.A.	N.A.	N.A.	N.A.	N.A.	N.A.	N.A.	N.A.	N.A.	N.A.	N.A.	N.A.

(1) Standard Rating Conditions for Air to water chillers according to EN14511:2 Outdoor Heat exchanger inlet dry bulb temperature 35°; Indoor heat exchanger inlet water temperature 12°C, outlet water temperature 7°C.  
 (2) The pressure drops for the filter are referred to the one provided by DAIKIN as option (option code 115). In case of filter provided by third party supplier the pressure drop in the table must not be considered.  
 (3) Total head of the pump.  
 (4) Available head external to the unit (already including the pressure drop in the exchanger and in the filter (if opt 115 is selected)  
 (5) Refer to 400 V power supply

The above data are referred to the unit without additional optional.  
 In case of unit with opt. 08, 154, 187 refer the selection sheet for the actual pressure drops.  
 The above data are referred the unit installed in compliancy with installation prescription.  
 All the data are subject to change without notice. For updated information on project base refer to Chiller Selection Software and unit nameplate.

EWAD~TZ X S/R C-

Dual pump – High Lift

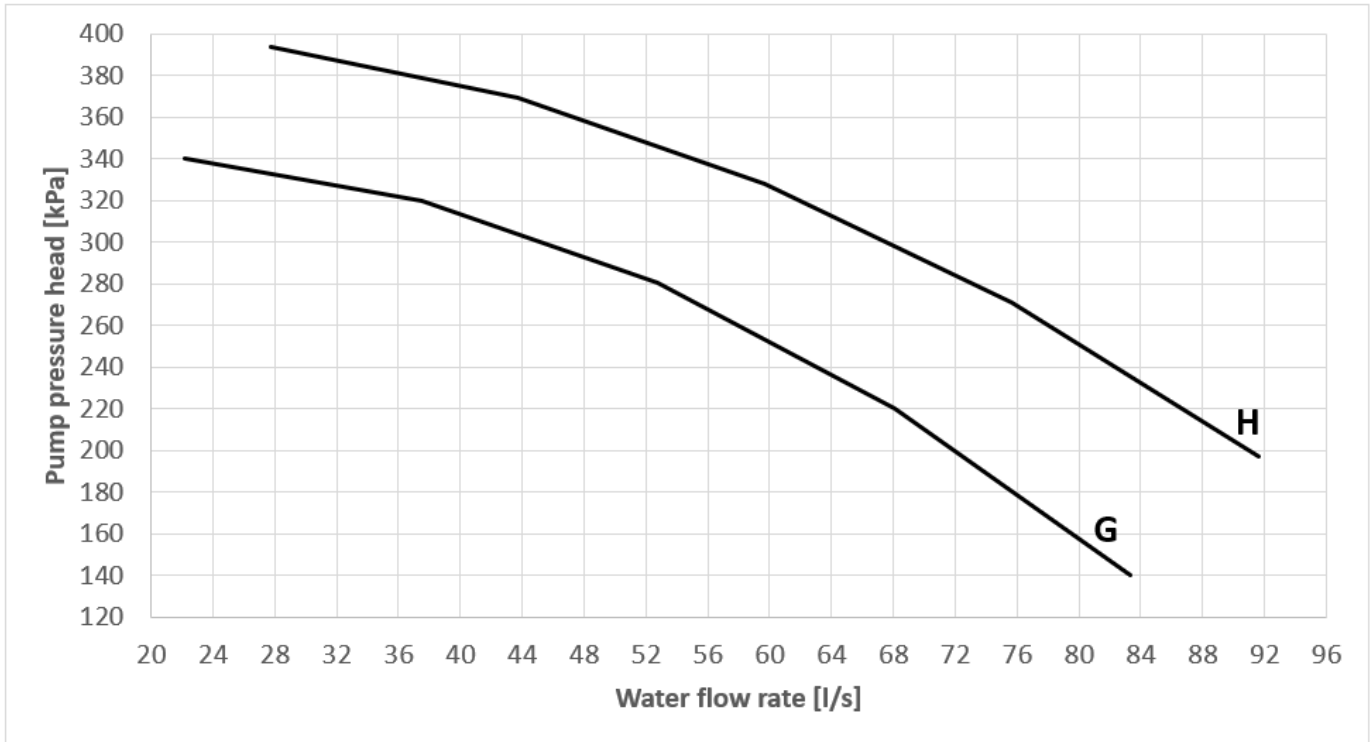

EWAD~TZ X- C / R134a – Dual Pump High Lift												
models	ref. curve	Pump motor power input	Pump motor current (5)	Power supply	PN	Motor protection	Insulation class	Water flow rate (1)	Evaporator pressure drop (1)	Filter pressure drop (2)	Pump water head @ std condition (3)	Available water head @ std condition (1) (4)
		kW	A	V – ph. – Hz	-	-	-	l/s	kPa	kPa	kPa	KPa
C11	G	22	42,2	400 - 3 - 50	10	IP55	F	53,6	52	10	277	216
C12	H	30	52,2	400 - 3 - 50	10	IP55	F	57,5	33	3	335	299
H12	H	30	52,2	400 - 3 - 50	10	IP55	F	61,1	37	4	324	283
C14	H	30	52,2	400 - 3 - 50	10	IP55	F	66,7	43	4	305	258
C15	N.A.	N.A.	N.A.	N.A.	N.A.	N.A.	N.A.	N.A.	N.A.	N.A.	N.A.	N.A.
H16	N.A.	N.A.	N.A.	N.A.	N.A.	N.A.	N.A.	N.A.	N.A.	N.A.	N.A.	N.A.
H17	N.A.	N.A.	N.A.	N.A.	N.A.	N.A.	N.A.	N.A.	N.A.	N.A.	N.A.	N.A.

(1) Standard Rating Conditions for Air to water chillers according to EN14511:2 Outdoor Heat exchanger inlet dry bulb temperature 35°; Indoor heat exchanger inlet water temperature 12°C, outlet water temperature 7°C.  
 (2) The pressure drops for the filter are referred to the one provided by DAIKIN as option (option code 115). In case of filter provided by third party supplier the pressure drop in the table must not be considered.  
 (3) Total head of the pump.  
 (4) Available head external to the unit (already including the pressure drop in the exchanger and in the filter (if opt 115 is selected)  
 (5) Refer to 400 V power supply

The above data are referred to the unit without additional optional.  
 In case of unit with opt. 08, 154, 187 refer the selection sheet for the actual pressure drops.  
 The above data are referred the unit installed in compliancy with installation prescription.  
 All the data are subject to change without notice. For updated information on project base refer to Chiller Selection Software and unit nameplate.

**Warning** Installation and maintenance of the unit must be performed only by qualified personnel who have knowledge with local codes and regulations, and experience with this type of equipment. Must be avoided the unit installation in places that could be considered dangerous for all the maintenance operations.

**Handling** Care should be taken to avoid rough handling or shock due to dropping the unit. Do not push or pull the unit from anything other than the base frame. Never allow the unit to fall during unloading or moving as this may result in serious damage. To lift the unit, rings are provided in the base frame of the unit. Spreader bar and cables should be arranged to prevent damage to cabinet.

**Location** The units are produced for outdoor installation on roofs, floors or below ground level on condition that the area is free from obstacles for the passage of the condenser air. The unit should be positioned on solid foundations and perfectly leveled; in the case of installation on roofs or floors, it may be advisable to arrange the use of suitable weight distribution beams. When the units are installed on the ground, a concrete base at least 250 mm wider and longer than the unit's footprint should be laid. Furthermore, this base should withstand the unit weight mentioned in the technical data table.

**Space requirements** Each side of the unit must be accessible after installation for periodic service. The following pictures shows you minimum recommended clearance requirements for service activities.

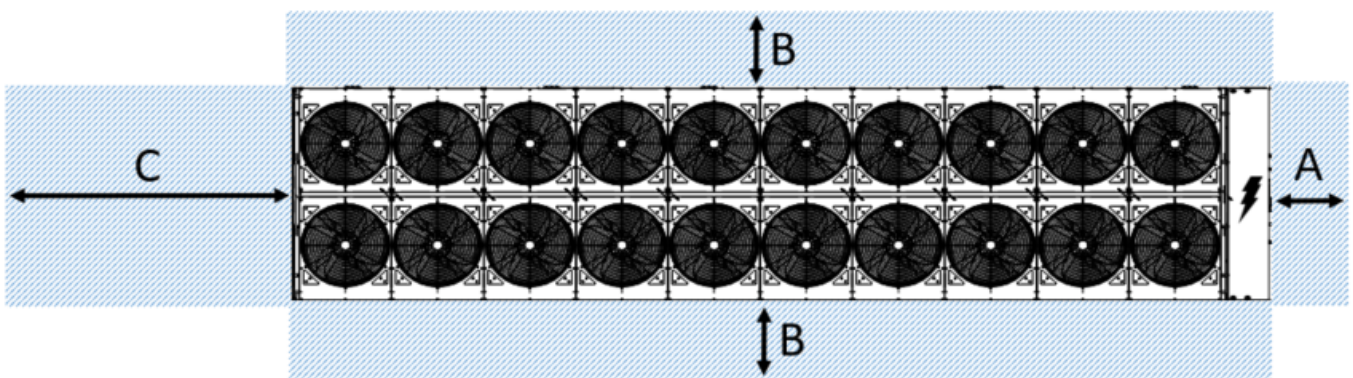

- A at least 1500 mm
- B at least 1800 mm
- C between 1800 and 3600 mm. To be checked on unit drawings.

These clearances ensure proper space to perform all possible maintenance activities and replacing of unit's components.

**NOTE: Installations with different (lower) clearances around the unit should be subjected and approved by local service referent.**

The units are air-cooled, then it is important to respect minimum distances which guarantee the best ventilation of the condenser coils. Limitations of space reducing the air flow could cause significant reductions in cooling capacity and an increase in electricity consumption.

To determinate unit placement, careful consideration must be given to assure a sufficient air flow across the condenser heat transfer surface.

Two conditions must be avoided to achieve the best performance: warm air recirculation and coil starvation. Both these conditions cause an increase of condensing pressures that results in reductions in unit efficiency and capacity.



For single chiller installation in proximity of a wall the following indications are recommended:

If H lower than chiller height and L must be at least 3 m no impact on chiller performances.

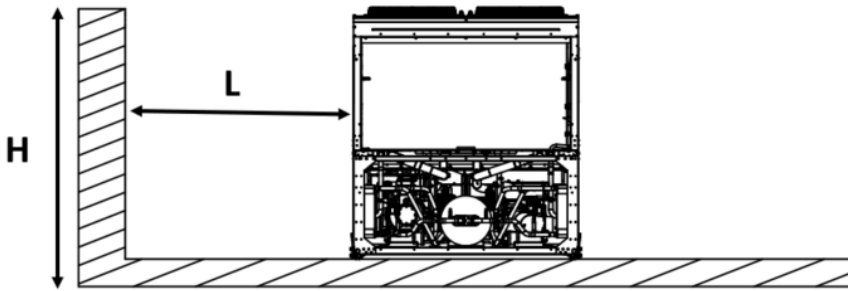

If H lower than chiller height and/or L shorter than 3 m chiller operation could be affected according to wind direction, ambient temperature. In such situation a proper analysis should be carried out to evaluate the impact on chiller operation considering all the specific boundary conditions.

Information on nominal air-flow are indicated in Technical specification tables.

The indicated airflow corresponds to an air velocity on condenser coil of  $\approx 2.7$  m/s.

Below some examples of possible derating due to installation conditions:

**1) Single chiller in a compound**

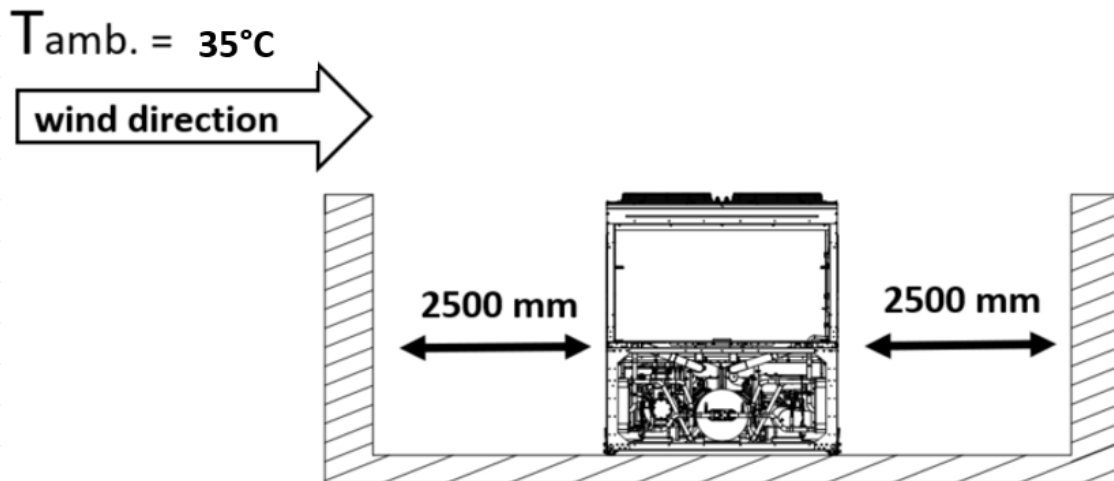

The walls have the same height of the chillers; ambient temperature =  $46^{\circ}\text{C}$

In this due to the wind direction air recirculation will occur leading to air condensing pressure.

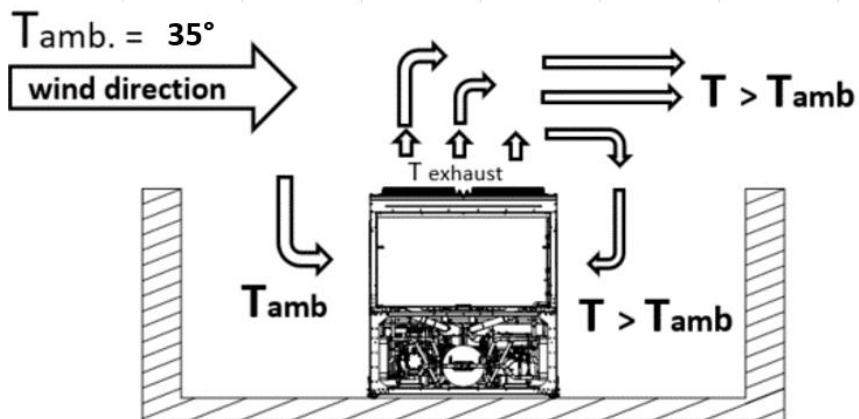

As result of this installation the impact on cooling capacity can be estimated in - 5% (avg. depending on unit size) on the catalog data.

2) Multiple chillers installed in line in a compound

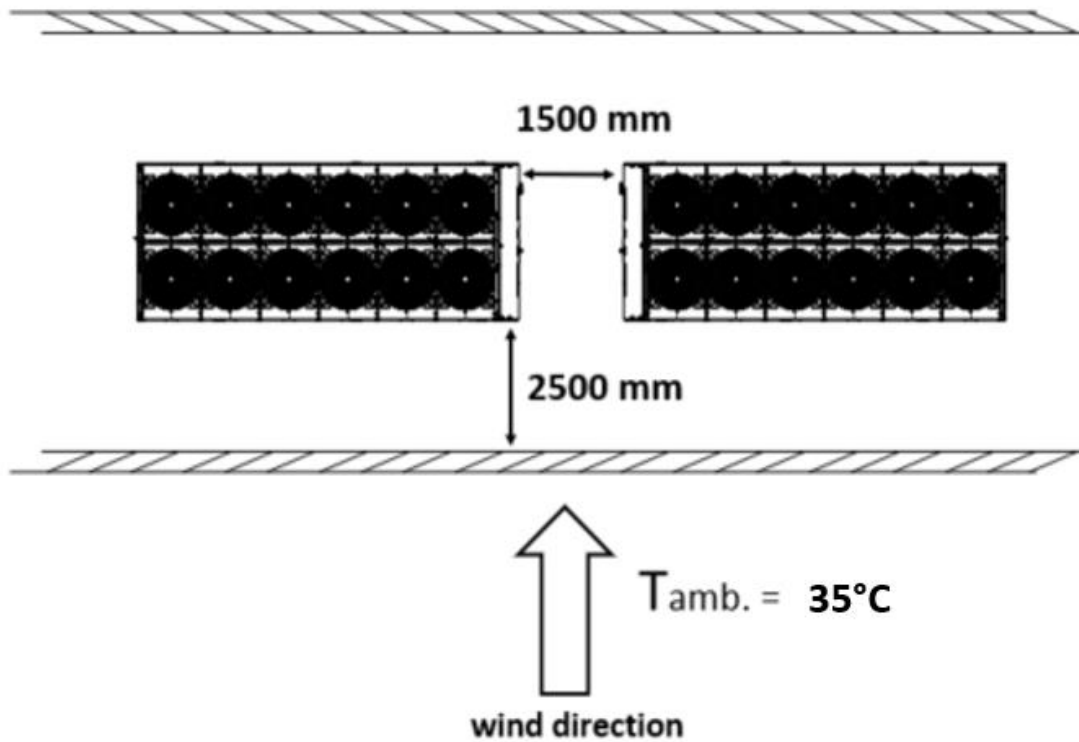

With walls having the same height of the chillers. The space between the chillers must be at least 1500 mm to ensure space to operate on the electrical panel. In this situation the impact on performances is the same of the previous.

3) Multiple chillers installed in parallel in a compound

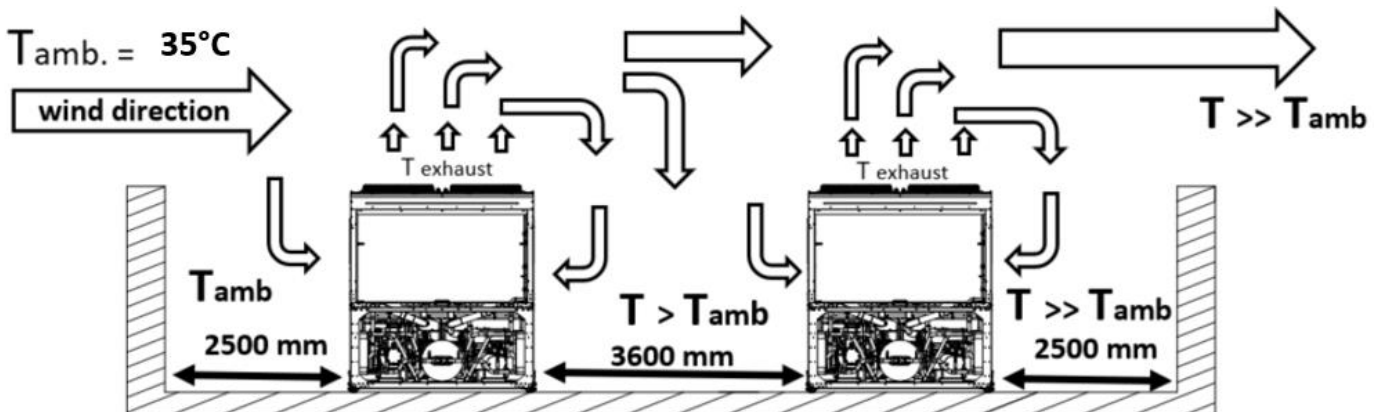

The walls have the same height of the chillers; ambient temperature =  $35^{\circ}\text{C}$ ;  
 The air temperature entering the second chiller is higher due to the mix with the exhaust air from 1th chiller in following the wind direction. The impact on the cooling capacity of the second chiller can be estimated in approximately -8% (avg. depending on unit size) on the catalog data.

4) Single chiller installed in a pit

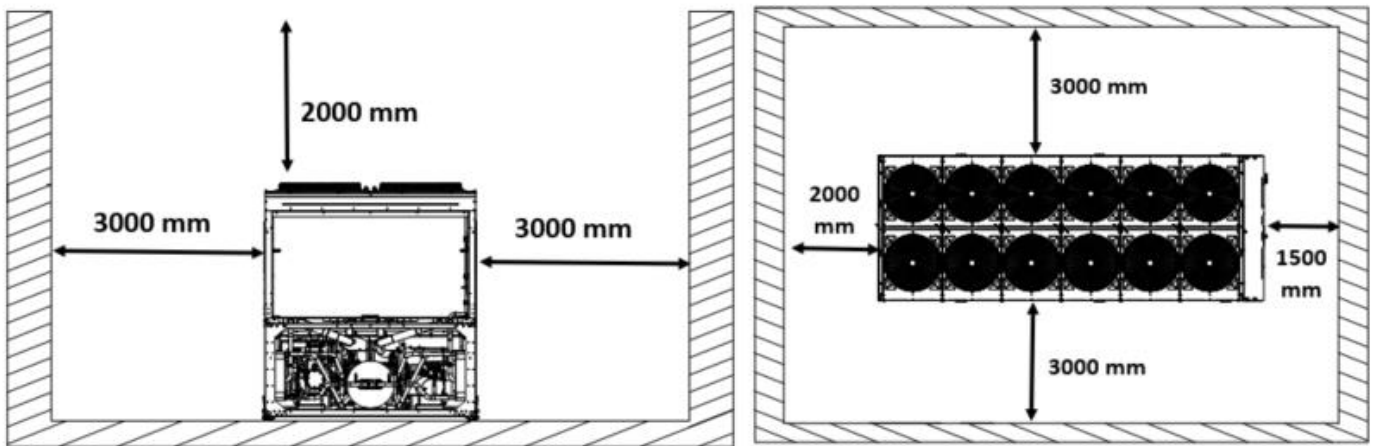

ambient temperature = 35°C.

In such situation the impact on cooling performances is about -15% (avg. depending on unit size) on catalog data.

To significantly reduce the negative effects countermeasures can be considered:

- Raise the chiller form the ground
- Provide ducts on fan's discharge.

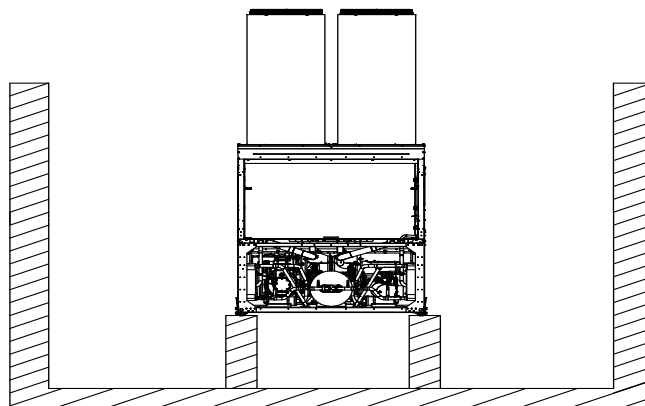

The above examples are intended as general guidelines and no comprehensive of all possible plant configuration and operating conditions.

In case of critical installation (not compliant with the advised clearances) should be analyzed by plant designer and proper to evaluate the impact on chiller operation and identify possible countermeasures.

## Water piping

The water system must have:

- Anti-vibration joint to reduce transmission of vibrations to the structures.
- Isolating valves to isolate the unit from the water system during maintenance.
- The evaporator must not be exposed to flushing velocities or debris released during flushing. It is recommended that a properly sized bypass completed with valve arrangement is installed to insulate chiller's water heat exchanger during the flushing of the piping system.
- Flow switch.
- Manual or automatic air venting device at the system's highest point.; drain device at the system's lowest point.
- A suitable device that can maintain the water system under pressure (expansion tank, etc.).
- Water temperature and pressure indicators to assist the operator during service and maintenance.
- A filter or device that can remove particles from the fluid. The installation of the filter is mandatory. The use of a filter extends the life of the evaporator and pump and helps to keep the water system in a better condition.
- Precautions should be provided to protect the unit against freezing.
- The heat recovery device must be emptied of water during the winter season, unless an ethylene glycol mixture in appropriate percentage is added to the water circuit.
- If case of unit substitution, the entire water system must be emptied and cleaned before the new unit is installed. Regular tests and proper chemical treatment of water are recommended after starting up the new unit.
- If glycol is added to the water system as anti-freeze protection, pay attention to the fact that suction pressure will be lower, the unit's performance will be lower and water pressure drops will be greater. All unit-protection systems, such as anti-freeze, and low-pressure protection will need to be readjusted.
- To avoid damages to evaporator during flushing operation a normally closed bypass should be installed.

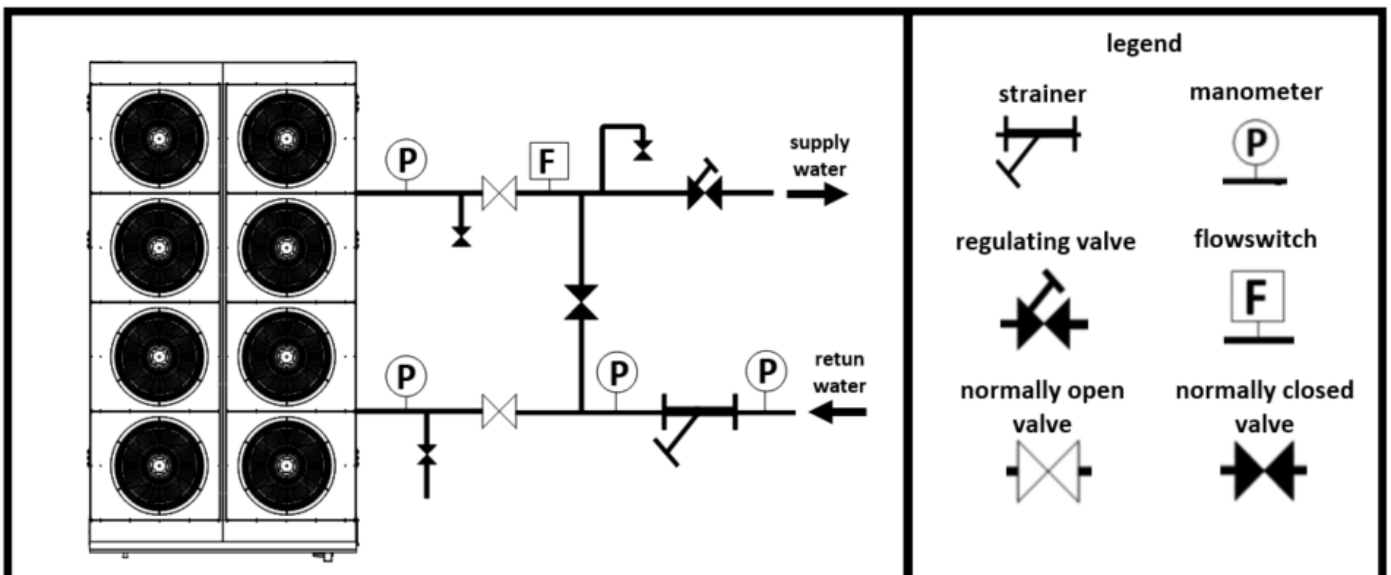

**General** The chiller will be designed and manufactured in accordance with the following European directives:

- Construction of pressure vessel 2014/68/EU
- Machinery Directive 2006/42/EC
- Low Voltage 2014/35/EU
- Electromagnetic Compatibility 2014/30/EU
- Electrical & Safety codes EN 60204-1 / EN 60335-2-40
- Manufacturing Quality Standards UNI – UNI EN ISO 1400

To avoid any losses, the unit will be tested at full load in the factory (at the nominal working conditions and water temperatures). The chiller will be delivered to the job site completely assembled and charged with refrigerant and oil.

The installation of the chiller must comply with the manufacturer’s instructions for rigging and handling equipment.

The unit will be able to start up and operate (as standard) at full load with:

- outside air temperature from ..... °C to ..... °C
- evaporator leaving fluid temperature between ..... °C and ..... °C
- 

**Refrigerant** HFO R1234ze(e) , HFC R134a

**Performance** Chiller shall supply the following performances:

- Number of chiller(s) : ..... unit(s)
- Cooling capacity for single chiller : ..... kW
- Power input for single chiller in cooling mode : ..... kW
- Heat exchanger entering water temperature in cooling mode : ..... °C
- Heat exchanger leaving water temperature in cooling mode : ..... °C
- Heat exchanger water flow : ..... l/s
- Nominal outside working ambient temperature in cooling mode : ..... °C
- Minimum full load efficiency (EER): ..... (kW/kW)
- Minimum part load efficiency (IPLV): ..... (kW/kW)

Operating voltage range should be 400V ±10%, 3ph, 50Hz, voltage unbalance maximum 3%, without neutral conductor and shall only have one power connection point.

**Unit description** Chiller shall include two or three independent refrigerant circuits, semi-hermetic type rotary single screw compressors, electronic expansion device (EEXV), direct expansion ‘shell & tube’ evaporator, air-cooled condenser section made with aluminum Microchannel technology, R-134a refrigerant, lubrication system, motor starting components, discharge line shut-off valve, control system and all components necessary for a safe and stable unit operation.

**Sound level and vibrations** Sound power level shall not exceed .....dB(A). The sound power levels must be rated in accordance to ISO 9614 and Sound Power rated according to ISO 3744 (other types of rating cannot be used). Vibration on the base frame should not exceed 2 mm/s.

**Dimensions** Unit dimensions shall not exceed following indications:

- Unit length ..... mm
- Unit width ..... mm
- Unit height ..... mm

**Compressors** The unit shall be equipped with:

- Semi-hermetic, single-screw type with one main helical rotor matching with gate rotor. The gate rotor will be constructed of a carbon impregnated engineered composite material. The gate rotor supports will be constructed of cast iron. Electrical motor shall be 2-pole, semi-hermetic, squirrel-cage induction type and cooled by suction gas.
- The compressor shall be provided with a built in, high efficiency, mesh type oil separator and oil filter.
- Refrigerant system differential pressure shall provide oil injection on all moving compressor parts to correctly lubricate them. Electrical oil pump lubricating system is not acceptable.
- The compressor’s oil cooling must be realized, when necessary, by refrigerant liquid injection. External dedicated heat exchanger and additional piping to carry the oil from the compressor to heat exchanger and vice versa will be not accepted.
- The compressor shall be direct electrical driven, without gear transmission between the screw and the electrical motor.
- The compressor casing shall be provided with ports to realize economized refrigerant cycles.
- The unit shall be provided with two thermal protection realized by a thermistor for high temperature protection: one temperature sensor to protect electrical motor and another sensor to protect unit and lubricating oil from high discharge gas temperature.

- The compressor shall be equipped with an electric oil-crankcase heater.
- Compressor shall be fully field serviceable. Compressor that must be removed and returned to the factory for service shall be unacceptable.

**Cooling capacity control system** the chiller will have a microprocessor for the control of the compressor capacity in order to continuously modulate the compressor's rotational speed.

- The unit capacity control shall be infinitely modulating between 100% and the minimum.
- The system shall control the unit based on the leaving evaporator water temperature that shall be controlled by PID (Proportional Integral Derivative) logic.

### Evaporator

The units shall be equipped with a direct expansion shell & tube evaporator with copper tubes rolled into steel tube sheets.

The external shell shall insulate with flexible, closed cell polyurethane insulation material (20 -mm thick).

- The evaporator will have 2 circuits, one for each compressor and shall be single refrigerant pass.
- The water connections shall be VICTAULIC type connections as standard to ensure quick mechanical disconnection between the unit and the hydronic network.
- The evaporator will be manufactured in accordance to PED approval.
- Flow switch on evaporator available as option (shipped loose).
- Water filter needs to be provided on the plant.

**Condenser coil** the condenser is made entirely of aluminum with flat tubes containing small channels. Full - depth louvered aluminum fins are inserted between the tubes maximizing the heat exchange. The Microchannel technology ensures the highest performance with the minimum surface for the exchanger. The quantity of refrigerant is also reduced compared to Cu/Al condenser. Special treatments ensure resistance to the corrosion by atmospheric agents extending the life time (available on request).

**Condenser fans** the condenser fans used in conjunction with the condenser coils, shall be propeller type with aluminum-magnesium alloy blades for higher efficiencies. Each fan shall be protected by a fan guard.

- The air discharge shall be vertical, and each fan must be coupled to the electrical motor, supplied as standard to IP54 and capable to work to ambient temperatures of - 20°C to + 65°C.
- The condenser fans shall have as a standard a thermally protection by internal thermal motor protection and protected by circuit breaker installed inside the electrical panel as a standard.

**Refrigerant circuit** the unit shall have two or three independent refrigerant circuits.

The circuit shall include as standard: electronic expansion device piloted by unit's microprocessor control, compressor discharge shut-off valves, economizer circuit, sight glass with moisture indicator, replaceable filter drier, charging valves, high pressure switch, high- and low-pressure transducers, oil pressure transducer and insulated suction line.

**Hydronic kit** options (on request) The hydronic module shall be integrated in the chiller chassis without increasing its dimensions and includes the following elements: centrifugal pump with motor protected by a circuit breaker installed in control panel, water filling system with pressure gauge, safety valve, drain valve.

- The hydronic module shall be assembled and wired to the control panel.
- A choice of two pump types shall be available:
  - in-line single pump
  - in-line twin pumps.

**Master / Slave** the unit shall be able to operate in Master / Slave mode in order to be connected with other similar unit (up to 4). The master unit shall manage the slaves connected in series on the hydraulic plant with the aim of optimize the running hours of each compressor and to balance running hours.

**iCM Standard** the unit shall be able to control the primary loop system (for systems up to 4 chillers) allowing in addition to the Master/Slave functionality also the capability to share the load among the unit according the optimal condition and managing also the primary pumps integrated on the unit or external. In case of external pumps, the control should be able to manage dedicated pumps as well as manifolded pumps including the stand-by pumps if present.

**Electrical control panel** Power and control shall be located in the main panel that will be manufactured to ensure protection against all weather conditions.

- The electrical panel shall be IP54 and (when opening the doors) internally protected against possible accidental contact with live parts.
- The main panel shall be fitted with a main switch interlocked door that shuts off power supply when opening.
- The power section will include compressors and fans protection devices, fans starters and control.

**Controller** The controller will be installed as standard and it will be used to modify unit set-points and check control parameters.

- A built-in display will show chiller operating status plus temperatures and pressures of water, refrigerant and air, programmable values, set-points.
- A sophisticated software with predictive logic, will select the most energy efficient combination of compressors, EEXV and condenser fans to keep stable operating conditions to maximize chiller energy efficiency and reliability.
- The controller will be able to protect critical components based on external signals from its system (such as motor temperatures, refrigerant gas and oil pressures, correct phase sequence, pressure switches and evaporator). The input coming from the high pressure switch cuts all digital output from the controller in less than 50ms, this will be an additional security for the equipment.
- Fast program cycle (200ms) for a precise monitoring of the system.
- Floating point calculations supported for increased accuracy in P/T conversions.

#### **Controller main features**

Controller shall be guaranteed following minimum functions:

- Management of the compressor stepless capacity and fans modulation.
- Chiller enabled to work in partial failure condition.
- Full routine operation at condition of:
  - high ambient temperature value
  - high thermal load
  - high evaporator entering water temperature (start-up)
- Display of evaporator entering/leaving water temperature.
- Display of Outdoor Ambient Temperature.
- Display of condensing-evaporating temperature and pressure, suction and discharge superheat for each circuit.
- Leaving water evaporator temperature regulation.
- Compressor and evaporator pumps hours counter.
- Display of Status Safety Devices.
- Number of starts and compressor working hours.
- Optimized management of compressor load.
- Fan management according to condensing pressure.
- Re-start in case of power failure (automatic / manual).
- Soft Load (optimized management of the compressor load during the start-up).
- Start at high evaporator water temperature.
- Return Reset (Set Point Reset based on return water temperature).
- OAT (Outside Ambient temperature) Reset.
- Set point Reset (optional).
- Application and system upgrade with commercial SD cards.
- Ethernet port for remote or local servicing using standard web browsers.
- Master / Slave (provided as standard)
- Two different sets of default parameters could be stored for easy restore.

#### **High Level Communications**

Interface (on request) The chiller shall be able to communicate to BMS (Building Management System) based on the most common protocols as:

- ModbusRTU
- LonWorks, now also based on the international 8040 Standard Chiller Profile and LonMark Technology
- BacNet BTP certified over IP



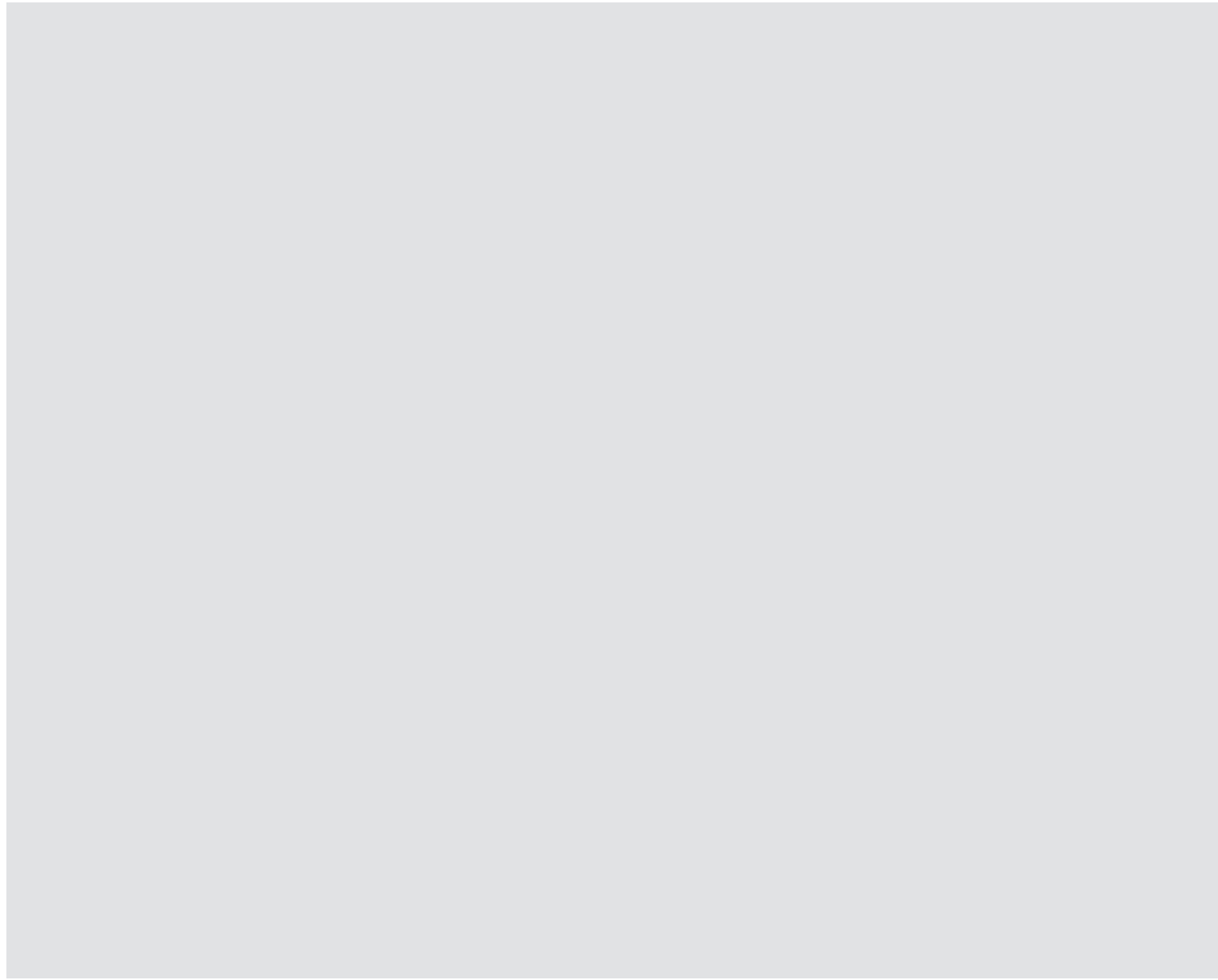

For more information email [info@daikinapplied.uk](mailto:info@daikinapplied.uk) or visit [www.daikinapplied.uk](http://www.daikinapplied.uk)

For all Daikin Applied UK,  
Daikin Applied Service &  
Spares enquiries call us on:  
**0345 565 2700**



Daikin Europe N.V. participates in the Eurovent Certified Performance programme for Liquid Chilling Packages and Hydronic Heat Pumps, Fan Coil Units and Variable Refrigerant Flow systems. Check ongoing validity of certificate:  
[www.eurovent-certification.com](http://www.eurovent-certification.com)

The present publication is drawn up by way of information only and does not constitute an offer binding upon Daikin Europe N.V. Daikin Europe N.V. has compiled the content of this publication to the best of its knowledge. No express or implied warranty is given for the completeness, accuracy, reliability or fitness for particular purpose of its content and the products and services presented therein. Specifications are subject to change without prior notice. Daikin Europe N.V. explicitly rejects any liability for any direct or indirect damage, in the broadest sense, arising from or related to the use and/or interpretation of this publication. All content is copyrighted by Daikin Europe N.V.

